

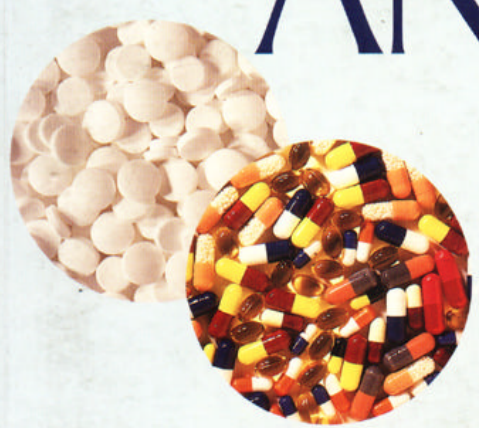

Pharmaceutical ANALYSIS



A Textbook for
Pharmacy Students and
Pharmaceutical Chemists

David G. Watson

CHURCHILL LIVINGSTONE

Pharmaceutical Analysis

*A Textbook for Pharmacy Students
and Pharmaceutical Chemists*

Pharmaceutical Analysis

*A Textbook for Pharmacy Students
and Pharmaceutical Chemists*

David G. Watson BSc PhD PGCE

Senior Lecturer in Pharmaceutical Sciences, School of Pharmacy,
University of Strathclyde, Glasgow, UK



EDINBURGH LONDON NEW YORK PHILADELPHIA ST LOUIS SYDNEY TORONTO 1999

CHURCHILL LIVINGSTONE
An imprint of Harcourt Publishers Limited

© Harcourt Publishers Limited 1999

 is a registered trademark of Harcourt Publishers Limited

The right of David G. Watson to be identified as author of this work has been asserted by him in accordance with the Copyright, Designs and Patents Act 1988.

All rights reserved. No part of this publication may be reproduced, stored in a retrieval system, or transmitted in any form by any means, electronic, mechanical, photocopying, recording or otherwise, without either the prior permission of the publishers (Harcourt Publishers Limited, Robert Stevenson House, 1-3 Baxter's Place, Leith Walk, Edinburgh EH1 3AF, UK), or a licence permitting restricted copying in the United Kingdom issued by the Copyright Licensing Agency, 90 Tottenham Court Road, London W1P 0LP.

First published 1999
Reprinted 2000

ISBN 0 443 05986 1

British Library Cataloguing in Publication Data

A catalogue record for this book is available from the British Library

Library of Congress Cataloging in Publication Data

A catalog record for this book is available from the Library of Congress

Note

Medical knowledge is constantly changing. As new information becomes available, changes in treatment, procedures, equipment and the use of drugs become necessary. The author and the publishers have, as far as it is possible, taken care to ensure that the information given in this text is accurate and up-to-date. However, readers are strongly advised to confirm that the information, especially with regard to drug usage, complies with the latest legislation and standards of practice.

Preface

I have aimed this book at an undergraduate audience of pharmaceutical science and chemistry students and the book gives an introduction to all the major techniques used in the analysis of pharmaceuticals

Rapid advances have been made in many analytical techniques over the last 10 years. To a larger extent than in many industries the quality control of pharmaceuticals has become very important and has driven the development of analytical techniques, particularly chromatographic techniques. Most of the existing books on pharmaceutical analysis tend to try to cover every aspect of a technique including elements in the technique which may be very seldom used and thus comprehensive books on this topic are long. I have covered a wide range of techniques in a relatively small amount of space by selecting what I consider to be the most important points involved in each technique, working on the theory that it is better to have grasped a few keypoints rather than a large number of facts which are best consulted when a particular problem with a technique arises. Thus for in-depth coverage of the more esoteric aspects of a technique, it would be better to consult a specialist textbook on that particular technique.

I have included self-assessment exercises to bring out the keypoints in most of the chapters and there is particular emphasis on simple arithmetical calculation of results from analytical data because, although this is easy after practice, the decline in arithmetical skills at undergraduate level requires some remedial attention.

One aspect of drugs that is not examined by other books on pharmaceutical analysis is the importance of the concept of a pK_a value, which has a bearing on a number of areas of analysis; this topic is not covered with any emphasis in most chemistry courses and I have tried to give it a particular emphasis in this book. Stereochemistry is also sometimes a source of confusion and its relation to drugs is discussed alongside some useful examples of this concept. As well as the instrumental techniques, I have also considered titrimetric methods which are still extensively used, particularly by pharmacopoeial monographs. I have had hands-on use of most of the instrumental techniques covered in the book (apart from capillary electrophoresis), where I have had to rely on the vicarious experience of seeing PhD students use this increasingly important technique, and near infrared and Raman spectroscopy, to which I do not have access.

The longest chapter deals with high-pressure liquid chromatography, which is the most widely used technique for the quality control of pharmaceuticals and which could fill several books until one realises that many analyses are based on a few

simple methods. Since my primary research interest has been in chromatography in conjunction with mass spectrometry I have resisted the temptation to describe this technique in too much depth since it is not central to pharmaceutical analysis, except perhaps in the burgeoning area of biotechnologically produced drugs. Mass spectrometry and nuclear magnetic resonance spectroscopy are usually placed among the more complex spectrochemical techniques and I have tried to reduce their complexity by showing their relevance to the analysis of drugs, which are often rather simple molecules compared to complex natural products where such techniques are relied on heavily to provide a solution to an unknown chemical structure. I have treated statistics fairly superficially since much of the time simple statistics are sufficient to determine whether or not an analysis is reliable.

I would like to thank my colleagues in the Department of Pharmaceutical Sciences for being such an entertaining bunch of people with which to share the frustrations of academic life in the late 20th century. Finally, I should also like to thank my wife and daughter for their patience with the late hours required to write this book in the face of a busy lecturing and research schedule.

D. G. Watson

1999

Contents

1. Control of the quality of analytical methods 1

- Introduction 1
- Control of errors in analysis 2
- Accuracy and precision 4
- Repeatability and reproducibility 6
- Standard operating procedure (SOP) for the assay of paracetamol tablets 8
- Compound random errors 9
- Reporting of results 10
- Other terms used in analytical procedures control 11

2. Physical and chemical properties of drug molecules 17

- Introduction 17
- Calculation of pH value of aqueous solutions of strong and weak acids and bases 18
- Acidic and basic strength and pK_a 20
- Henderson–Hasselbalch equation 20
- Ionisation of drug molecules 21
- Buffers 23
- Salt hydrolysis 26
- Activity, ionic strength and dielectric constant 27
- Partition coefficient 28
- Drug stability 31
- Stereochemistry of drugs 32
- Measurement of optical rotation 38
- Profiles of physico-chemical properties of some drug molecules 39
- Additional problems 46

3. Titrimetric and chemical analysis methods 49

- Keypoints 49
- Introduction 50
- Instrumentation and reagents 50
- Direct acid/base titrations in the aqueous phase 51
- Indirect titrations in the aqueous phase 54

Non-aqueous titrations	56
Argentometric titrations	58
Compleximetric titrations	58
Redox titrations	59
Iodometric titrations	61
Ion pair titrations	63
Diazotisation titrations	64
Potentiometric titrations	65
Karl Fischer titration	68
Automation of wet chemical methods	68
Applications of FIA in pharmaceutical analysis	71

4. Ultraviolet and visible spectroscopy 75

Keypoints	75
Introduction	76
Factors governing absorption of radiation in the UV/visible region	77
Beer-Lambert Law	79
Instrumentation	80
Instrument calibration	80
UV spectra of some representative drug modules	82
Use of UV/visible spectrophotometry to determine pKa values	85
Application of UV/visible spectrophotometry to pharmaceutical quantitative analysis	86
Difference spectrophotometry	90
Derivative spectra	92
Applications of UV/visible spectrophotometry in preformulation and formulation	94

5. Infrared spectrophotometry 97

Keypoints	97
Introduction	98
Factors determining intensity and energy level of absorption in IR spectra	99
Instrumentation	100
Sample preparation	102
Application of IR spectrophotometry in structure elucidation	104
Examples of IR spectra of drug molecules	104
IR spectrophotometry as a fingerprint technique	110

Near-infrared analysis (NIRA) 112

Key points	112
Introduction	112
Examples of NIRA application	113
Additional problems	116

6. Atomic spectrophotometry 119

Atomic emission spectrophotometry 119

Keypoints	119
-----------	-----

Introduction	119
Instrumentation	120
Examples of quantitation by AES	121
Interferences in AES	123
Assays based on the method of standard additions	123

Atomic absorption spectrophotometry 125

Keypoints	125
Introduction	126
Instrumentation	126
Examples of assays using AAS	127
Examples of limit tests employing AAS	129
Inductively coupled plasma emission spectrophotometry	130

7. Molecular emission spectroscopy 133

Fluorescence spectroscopy 133

Keypoints	133
Introduction	134
Instrumentation	134
Molecules which exhibit fluorescence	135
Factors interfering with fluorescence intensity	136
Applications of fluorescence spectrophotometry in pharmaceutical analysis	137

Raman spectroscopy 140

Keypoints	140
Introduction	140
Instrumentation	141
Applications	142

8. Nuclear magnetic resonance spectroscopy 145

Keypoints	145
Introduction	146
Instrumentation	147
Proton NMR	148
Application of NMR to structure confirmation in some drug molecules	155
Carbon-13 NMR	159
Two dimensional NMR spectra	161
Application of NMR to quantitative analysis	163
Other specialised applications of NMR	164

9. Mass spectrometry 167

Keypoints	167
Introduction	168
Instrumentation	168
Mass spectra obtained under electron impact (EI) ionisation conditions	170
Molecular fragmentation mechanisms	171
EI mass spectra of some drug molecules	175

Gas chromatography–mass spectrometry (GC–MS)	180
Applications of GC–MS to impurity profiling	183
Liquid chromatography–mass spectrometry (LC–MS)	186
Applications of LC–MS in pharmaceutical analysis	188

10. Chromatographic theory 195

Introduction	195
Void volume and capacity factor	195
Calculation of column efficiency	196
Origins of band broadening in HPLC	197
Parameters used in evaluating column performance	201
Data acquisition	203
Report generation	204

11. Gas chromatography 207

Keypoints	207
Introduction	208
Instrumentation	208
Selectivity of liquid stationary phases	212
Use of derivatisation in GC	219
Summary of parameters governing capillary GC performance	220
GC detectors	222
Applications of GC in quantitative analysis	224
Determination of manufacturing and degradation residues by GC	229
Determination of residual solvents	231
Applications of GC in bioanalysis	233
Additional problems	234

12. High pressure liquid chromatography 237

Keypoints	238
Introduction	238
Instrumentation	238
Stationary and mobile phases	239
Structural factors which govern rate of elution of drugs from HPLC columns	241
Summary of stationary phases used in HPLC	246
Summary of detectors used in HPLC	248
Performance of a diode array detector (DAD)	250
Applications of HPLC to the quantitative analysis of drugs in formulations	252
Assays involving more specialised HPLC techniques	264
Additional problems	274

13. Thin layer chromatography 277

Keypoints	277
Introduction	278
Instrumentation	278
TLC chromatogram	278

Stationary phases	280
Elutropic series and mobile phases	280
Modification of TLC adsorbant	283
Detection of compounds on TLC plates following development	285
Applications of TLC analysis	286
HPTLC	290

14. High performance capillary electrophoresis 293

Keypoints	293
Introduction	294
Instrumentation	298
Control of separation	299
Applications of CE in pharmaceutical analysis	300
Additional problems	311

15. Extraction methods in pharmaceutical analysis 313

Keypoints	313
Introduction	314
Commonly used excipients in formulations	314
Solvent extraction methods	315
Solid phase extraction (SPE)	319
Keypoints	319
Introduction	320
Methodology	320
Types of adsorbants used in SPE	321
Adaptation of SPE for automated online extraction prior to HPLC analysis	327

Index	329
--------------	------------

Control of the quality of analytical methods

Introduction	reproducibility	Analytical blank
Control of errors in analysis	Between-laboratory reproducibility	Calibration
Accuracy and precision		Limit of detection
Repeatability and reproducibility	Standard operating procedure (SOP) for the assay of paracetamol tablets	Linearity
Within-assay precision	Compound random errors	Range
Repeatability	Reporting of results	Robustness
Between-day repeatability	Other terms used in analytical procedures control	Selectivity
Within-laboratory		Sensitivity
		Weighing by difference

Box 1.1 Questions pharmaceutical analysis methods are used to answer

- Is the identity of the drug in the formulated product correct?
- What is the percentage of the stated content of a drug present in a formulation?
- Does this formulation contain solely the active ingredient or are additional impurities present?
- What is the stability of a drug in the formulation and hence the shelf-life of the product?
- At what rate is the drug released from its formulation so that it can be absorbed by the body?
- Do the identity and purity of a pure drug substance to be used in the preparation of a formulation meet specification?
- Do the identity and purity of excipients to be used in the preparation of a formulation meet specification?
- What are the concentrations of specified impurities in the pure drug substance?
- What is the concentration of the drug in a sample of tissue or biological fluid?
- What are the pKa value(s), partition coefficients, solubilities and stability of a drug substance under development?

Introduction

Pharmaceutical analysis procedures may be used to answer any of the questions outlined in Box 1.1 above. The quality of a product may deviate from the standard required but in carrying out an analysis one also has to be certain that the quality of the analysis itself is of the standard required. Quality control is integral to all

modern industrial processes and the pharmaceutical industry is no exception. Testing a pharmaceutical product involves chemical, physical and sometimes microbiological analyses. It has been estimated that £10 billion is spent each year on analyses in the UK alone and such analytical processes can be found in industries as diverse as those producing food, beverages, cosmetics, detergents, metals, paints, water, agrochemicals, biotechnological products and pharmaceuticals. With such large amounts of money being spent on analytical quality control, great importance must be placed on providing accurate and precise analyses. Thus it is appropriate to begin a book on the topic of pharmaceutical analysis by considering, at a basic level, the criteria which are used to judge the quality of an analysis. The terms used in defining analytical quality form a rather elegant vocabulary that can be used to describe quality in many fields and in writing this book the author would hope to describe each topic under consideration with accuracy, precision and most importantly with reproducibility so that the information included in it can be readily assimilated and reproduced where required by the reader. The following sections provide an introduction to the control of analytical quality. More detailed treatment of the topic is given in the reference cited at the end of the chapter.¹

Control of errors in analysis

A quantitative analysis is not a great deal of use unless there is some estimation of how prone to error the analytical procedure is. Simply accepting the analytical result could lead to rejection or acceptance of a product on the basis of a faulty analysis. For this reason it is usual to make several repeat measurements of the same sample in order to determine the degree of agreement between them. There are three types of errors which may occur in the course of an analysis: gross, systematic and random. Gross errors are easily recognised since they involve a major breakdown in the analytical process such as samples being spilt, wrong dilutions being prepared or instruments breaking down or being used in the wrong way. If a gross error occurs the results are rejected and the analysis is repeated from the beginning. Random and systematic errors can be distinguished in the following example:

A batch of paracetamol tablets are stated to contain 500 mg of paracetamol per tablet; for the purpose of this example it is presumed that 100% of the stated content is the correct answer. Four students carry out a spectrophotometric analysis of an extract from the tablets and obtain the following percentages of stated content for the repeat analysis of paracetamol in the tablets:

Student 1: 99.5%, 99.9%, 100.2%, 99.4%, 100.5%

Student 2: 95.6%, 96.1%, 95.2%, 95.1%, 96.1%

Student 3: 93.5%, 98.3%, 92.5%, 102.5%, 97.6%

Student 4: 94.4%, 100.2%, 104.5%, 97.4%, 102.1%

The means of these results can be simply calculated according to the formula:

$$\bar{x} = \sum_i \frac{x_i}{n} \quad \text{[Equation 1]}$$

Where \bar{x} is the arithmetic mean, x_i is the individual value and n is the number of measurements.

These results can be seen diagrammatically in Figure 1.1.

of
precision
tablet

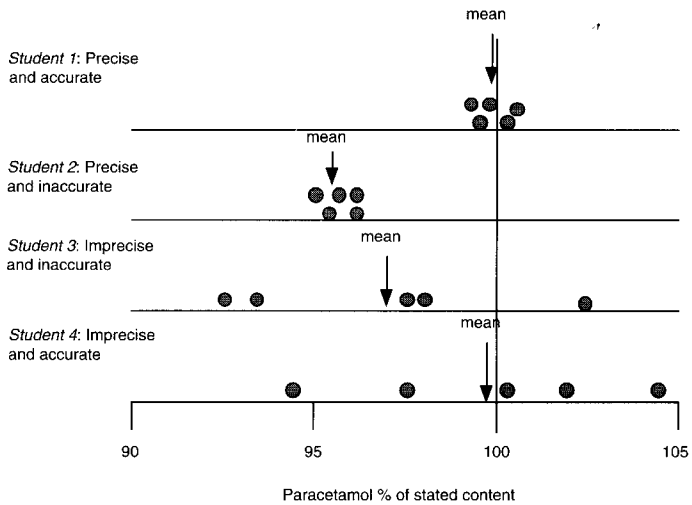

Student 1 has obtained a set of results which are all clustered close to 100% of the stated content and with a mean for the five measurements very close to the correct answer. In this case the measurements made were both precise and accurate and obviously the steps in the assay have been controlled very carefully.

Student 2 has obtained a set of results which are closely clustered but give a mean which is less than the correct answer. Thus although this assay is precise it is not completely accurate. Such a set of results indicates that the analyst has not produced random errors which would produce a large scatter in the results but has produced an analysis containing a systematic error. Such errors might include repeated inaccuracy in the measurement of a volume or failure to zero the spectrophotometer correctly prior to taking the set of readings. The analysis has been mainly well controlled except for probably one step which has caused the inaccuracy and thus the assay is precisely inaccurate.

Student 3 has obtained a set of results which are widely scattered and hence imprecise, and which give a mean which is less than the correct answer. Thus the analysis contains random errors or possibly, looking at the spread of the results, three defined errors which have been produced randomly. The analysis was thus poorly controlled and it would require more work than that required in the case of student 2 to eliminate the errors. In such a simple analysis the random results might simply be produced by, for instance, a poor pipetting technique where volumes both higher and lower than that required were measured.

Student 4 has obtained a set of results which are widely scattered yet a mean which is close to the correct answer. It is probably only chance that separates the results of student 4 from those of student 3 and although the answer obtained is accurate, it would not be wise to trust it to always be so.

The best assay was carried out by student 1 and student 2 produced an assay which might be improved with a little work.

In practice it might be rather difficult to tell whether student 1 or student 2 had carried out the best analysis since it is rare, unless the sample is a pure analytical standard, that the exact content of a sample is known. In order to determine whether

student 1 or 2 had carried out the best assay it might be necessary to get other analysts to obtain similar sets of precise results in order to be absolutely sure of the correct answer. The factors leading to imprecision and inaccuracy in assay results are outlined in Box 1.2.

Box 1.2 Some factors giving rise to imprecision and inaccuracy in an assay

- Incorrect weighing and transfer of analytes and standards
- Inefficient extraction of the analyte from a matrix, e.g. tablets
- Incorrect use of pipettes, burettes or volumetric flasks for volume measurement
- Measurement carried out using improperly calibrated instrumentation
- Failure to use an analytical blank
- Selection of assay conditions that cause degradation of the analyte
- Failure to allow for or to remove interference by excipients in the measurement of an analyte

Self-test 1.1

Suggest how the following might give rise to errors in an analytical procedure:

- Analysis of a sucrose-based elixir using a pipette to measure aliquots of the elixir for analysis.
- Weighing out 2 mg of an analytical standard on a four-place analytical balance which weighs a minimum of 0.1 mg.
- Use of an analytical standard that absorbs moisture from the atmosphere.
- Incomplete powdering of coated tablets prior to extraction.
- Extraction of an ointment with a solvent in which it is poorly soluble.
- Use of a burette that has not been rinsed free of traces of a detergent.

Answers: (i) Viscosity leads to incomplete drainage of the pipette; (ii) In any weighing there is an uncertainty of ± 0.05 mg which in relation to 2 mg is $\pm 2.5\%$; (iii) The degree of moisture absorption is uncertain; (iv) Poor recovery of the analyte; (v) Poor recovery of the analyte; (vi) Loss of meniscus making reading of the burette inaccurate

Accuracy and precision

The most fundamental requirements of an analysis are that it should be accurate and precise. It is presumed, although it cannot be proven, that a series of measurements (y) of the same sample will be normally distributed about a mean (μ) i.e. they fall into a Gaussian pattern as shown in Figure 1.2.

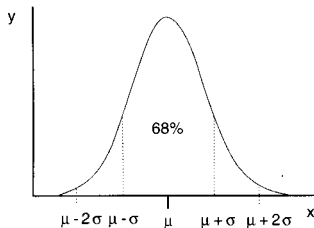

Fig. 1.2
The Gaussian distribution.

The distance σ shown in Figure 1.2 appears to be nearly 0.5 of the width of distribution, however, because the function of the curve is exponential it tends to

zero and does not actually meet the y axis until infinity where there is an infinitesimal probability that there may be a value for x. For practical purposes approximately 68% of a series of measurements should fall within the distance σ either side of the mean and 95% of the measurements should lie with 2σ of the mean. The aim in an analysis is to make σ as small a percentage of the value of μ as possible. The value of σ can be estimated using the Equation 2:

$$s = \sqrt{\frac{\sum(x_i - \bar{x})^2}{(n - 1)}} \quad \text{[Equation 2]}$$

s = standard deviation

n = number of samples

x_i = values obtained for each measurement

\bar{x} = mean of the measurements

Sometimes n rather than $n - 1$ is used in the equation but, particularly for small samples, it tends to produce an underestimate of σ . For a small number of values it is simple to work out s using a calculator and the above equation. Most calculators have a function which enables calculation of s directly and on calculators σ estimated using the above equation is usually labelled as σ_{n-1} . For instance if the example of results obtained by student 1, where the mean is calculated to be 99.9%, are substituted into equation 2 the following calculation results:

$$\begin{aligned} s &= \sqrt{\frac{\sum(99.5 - 99.9)^2 + (99.9 - 99.9)^2 + (100.2 - 99.9)^2 + (99.4 - 99.9)^2 + (100.5 - 99.9)^2}{(5 - 1)}} \\ &= \sqrt{\frac{\sum(-0.4)^2 + (0)^2 + (0.3)^2 + (-0.5)^2 + (0.6)^2}{4}} \\ &= \sqrt{\frac{0.16 + 0 + 0.09 + 0.25 + 0.36}{4}} = \sqrt{\frac{0.86}{4}} = \sqrt{0.215} = 0.46 \\ s &= 0.46\% \text{ of stated content} \end{aligned}$$

The calculated value for s provides a formal expression of the scatter in the results from the analysis rather than the visual judgement used in Figure 1.1. From the figure obtained for the standard deviation (SD) we can say that 68% of the results of the analysis will lie within the range $99.9 \pm 0.46\%$ ($\pm \sigma$) or within the range 99.44–100.36%. If we re-examine the figures obtained by student 1 it can be seen that 60% of the results fall within this range, with two outside the range including one only very slightly below the range. The range based on $\pm \sigma$ defines the 68% confidence limits; for 95% confidence $\pm 2\sigma$ must be used, i.e. 95% of the results of student 1 lie within $99.9 \pm 0.92\%$ or 98.98–100.82%. It can be seen that this range includes all the results obtained by student 1.

The precision of an analysis is often expressed as the \pm relative standard deviation (\pm RSD) (Equation 3).

$$\text{RSD} = \frac{s}{\bar{x}} \times 100\% \quad \text{[Equation 3]}$$

The confidence limits in this case are often not quoted but since it is the SD that is an estimate of σ which is being used they are usually 68%. The advantage of

expressing precision in this way is that it eliminates any units and expresses the precision as a percentage of the mean. The results obtained from the assay of paracetamol tablets are shown in Table 1.1.

Table 1.1 Results obtained for the analysis of paracetamol tablets by four analysts

Student	Mean (% of stated content)	S (% of stated content)	± RSD (68% confidence)
1	99.9	0.5	± 0.5%
2	95.6	0.5	± 0.5%
3	96.9	4.0	± 4.4%
4	99.7	4.0	± 4.0%

Self-test 1.2

Four analysts obtain the following data for a spectrophotometric analysis of an injection containing the local anaesthetic bupivacaine. The stated content of the injection is 0.25% weight in volume (w/v).

Analyst 1: 0.245% w/v, 0.234% w/v, 0.263% w/v, 0.261% w/v, 0.233% w/v.

Analyst 2: 0.236% w/v, 0.268% w/v, 0.247% w/v, 0.275% w/v, 0.285% w/v.

Analyst 3: 0.248% w/v, 0.247% w/v, 0.248% w/v, 0.249% w/v, 0.253% w/v.

Analyst 4: 0.230% w/v, 0.233% w/v, 0.227% w/v, 0.230% w/v, 0.229% w/v.

Calculate the mean percentage of stated content and RSD for each set of results at the 68% confidence level. Assuming the content really is as stated on the label, comment on the accuracy and precision of each set of results. Calculate the precision of each assay with regard to 95% confidence limits.

Answers: *Analyst 1:* 98.9% ± 5.8%: accurate and but imprecise. At 95% confidence RSD = ± 15.4%.
Analyst 2: 104.9 ± 7.7%: inaccurate and imprecise. At 95% confidence RSD = ± 11.6%.
Analyst 3: 99.6% ± 0.9%: accurate and precise. At 95% confidence RSD = ± 1.8%.
Analyst 4: 91.9% ± 0.9%: inaccurate and precise. At 95% confidence RSD = ± 1.8%.

Repeatability and reproducibility

In order for an assay to be valid it must be possible to get it to work on every occasion. The terms of repeatability and reproducibility are often rather poorly defined to the extent that they don't add very much to the general concept of precision. In order to prevent overlap of the terms it is necessary to extend their scope. First it is necessary to define in more specific terms what is meant by the precision of an assay.

Within-assay precision

The precision of an assay is a measure of its ability to produce close agreement between the results for several determinations of the same sample. Precision is a fairly general term since it applies to the assay as it is described and the extent of the details given for an assay may vary. There is no general agreement as to whether all the operations within an assay are being assessed in determining precision. For instance in a spectrophotometric assay a single weighing and extraction of a sample may be made and then several aliquots of the extract may be taken and diluted to the concentration required for analysis in order to assess the precision of the method. The precision of the weighing and extraction steps is not assessed. This is understandable since if the precision of every aspect of an assay were assessed then a very large number of samples would be generated. For instance if five samples of tablets were powdered and from each batch of powdered tablets five samples were

weighed out and extracted separately and then five dilutions were prepared from each extract, a total of 125 samples would be generated, which is rather an overkill. Even in relatively simple assays such as titrations the question arises as to whether or not one should make up several solutions of the titrant and standardise all of them before carrying out the assay. Thus precision of an assay cannot be a fixed term and it is an assessment of the assay as it was carried out and as such should be called the *within-assay precision*. If the number of operations which were assessed in order to determine the within-assay precision was inadequate then it would exhibit poor repeatability. For instance, if it really was necessary to assess the precision of the extraction step in the assay of paracetamol tablets then this would confound attempts to repeat the analysis on another occasion and achieve the same accuracy and precision. Thus it is useful to distinguish between *repeatability* and *within-assay precision* since it enables the routine assay to be limited to a sensible number of repetitive steps.

Repeatability

This differs from simple within-assay precision in that it might be considered to compare the sum total of the operations carried out in an assay of a particular sample from the beginning, carried out by a single operator, with the same sum total of all critical operations, carried out by the same operator, probably in sequence with the initial assay and certainly within the same day.

Where repeatability is being assessed the sum total of operations in an assay might be considered to include the following:

- (i) The weighing out of all standards and samples
- (ii) Fresh preparation and standardisation of all solutions involved in the quantitative aspects of the assay
- (iii) All dilution and extraction steps involved in the assay being carried out from the beginning.

Thus repeatability is a catch-all term and allows for the assessment of the precision of some of the steps which may have been missed from the routine assay. If repeatability is poor some extra operations may within the routine assay need to be assessed for precision.

Between-day repeatability

This concept is simply as suggested in the term that the repeatability is assessed on separate days or even separated by several days by the same operator.

Within-laboratory reproducibility

Reproducibility is often used in the way that repeatability has been defined above but this does not leave room for a term defining what happens when an analytical procedure is handed over to another analyst. Since in the art world reproduction relates to copying of an original by another artist it would seem appropriate to use the term in the same way in analytical chemistry. If an assay is carried out in a laboratory by several analysts it is unlikely that these analysts will weigh out identical amounts of sample and use identical items of equipment. A clearly defined assay procedure should be capable of being reproduced by a number of analysts in a laboratory. Furthermore, having confidence in its reproducibility should facilitate

staff training and give confidence in the overall control of other parts of the analytical process such as calibration and handling of a range of equipment.

Between-laboratory reproducibility

If a laboratory was fully confident in a particular assay it might submit it for testing by several laboratories, which would give a measure of how reproducible the assay was in a wider sense with different operators and equipment. For an assay to succeed in this type of exercise it would have to be very *robust*. For example pharmacopoeial monographs are designed, in theory, to be sufficiently robust to be reproduced relatively easily by many laboratories. However, the tolerances for the precision of such assays might be quite wide.

Standard operating procedure (SOP) for the assay of paracetamol tablets

The terms defined above are perhaps illustrated by using the example of the simple assay which we have mentioned before. The assay in Box 1.3 is laid out in the style of a SOP. This particular section of the operating procedure describes the assay itself but there would also be other sections in the procedure dealing with safety issues, the preparation and storage of the solutions used for extraction and dilution, the glassware required and a specification of the instrumentation to be used.

Box 1.3 Extract from a standard operating procedure for the analysis of paracetamol tablets

8. Assay procedure

8.1 Use a calibrated balance

8.2 Weigh 20 tablets

8.3 Powder the 20 paracetamol tablets and weigh *by difference* a quantity of tablet powder equivalent to 125 ± 10 mg of paracetamol

8.4 Shake the tablet powder sample with *ca* 150 ml of acetic acid (0.05 M) for 10 min in a 500 ml volumetric flask and then adjust the volume to 500 ml with more acetic acid (0.05 M).

8.5 Filter *ca* 100 ml of the solution into a conical flask and then transfer five separate 5 ml aliquots of the filtrate to 100 ml volumetric flasks and adjust the volumes to 100 ml with acetic acid (0.05 M)

8.6 Take two readings of each dilution using a UV spectrophotometer and using the procedure specified in **Section 9**

The assay described in Box 1.3 assesses the precision of some of the operations within the assay. If a single analyst was to assess the *repeatability* of the assay, instructions might be issued to the effect the assay as described was to be repeated five times in sequence, i.e. completing one assay before commencing another. If *between-day repeatability* were to be assessed the process used for determining the repeatability would be repeated on two separate days. If the *within-laboratory reproducibility* were to be assessed two or more analysts would be assigned to carry out the *repeatability* procedure. In arriving at a SOP such as the one described in Box 1.3 there should be some justification in leaving out certain steps in the complete assay. For instance, weighing is often the most precise step in the process and thus repeat weighings of samples of tablet powder would not be necessary to guarantee precision; the precision of the extraction might be more open to question.

Each of the sections within an assay would have other SOPs associated with them governing, for instance, the correct use and care of balances as listed in Box 1.4.

Box 1.4 Procedure for the use of a calibrated balance SOP/001A/01

This balance is a high-grade analytical balance. It carries out internal calibration but as a double check it is checked with certified check weights. Any deviation of the check weight values from those expected indicates need for servicing of the balance. Check weight calibration should be carried out once a week according to the instructions in SOP/001C/01.

Caution: The logbook (form SOP/001 AR/01) must be filled in. Any spillages on the balance must be cleaned up immediately and recorded in the log. This balance is to be used only for analytical grade weighings.

Operation

1. When carrying out weighing of amounts < 50 mg use tweezers to handle the weighing vessel.
2. Make sure the door of the balance is shut. Switch on the balance and allow it to undergo its internal calibration procedure. When it is ready the digital read-out will be 0.0000. Wait 30 s to ensure that the reading has stabilised.
3. Introduce the weighing vessel onto the balance pan. Close the door. Wait 30 s to ensure that the reading has stabilised and then send the reading to the printer.
4. If the tare is used in the weighing procedure, press the tare button and wait until the balance reads 0.0000. Wait 30 s to ensure that the reading has stabilised. If it drifts, which under normal circumstances it should not, press the tare button again and wait for a stable reading.
5. Remove the weighing vessel from the balance, introduce the sample into the vessel and put it back onto the balance pan. Close the door and note the reading.
6. Remove the sample and adjust the sample size to bring it closer to the required amount. Re-introduce the sample onto the balance pan. Close the door and note the reading.
7. Repeat step 5 until the target weight is reached. When the required weight is reached wait 30 s to ensure that the reading has stabilised. Send the reading to the printer.

N.B. An unstable reading may indicate that moisture is being lost or gained and that the sample must be weighed in a capped vessel.

Date of issue: 6/10/95

Signature:

Compound random errors

Systematic errors in analysis can usually be eliminated but true random errors are due to operations in an assay which are not completely controlled. A common type of random error arises from the acceptance of manufacturers' tolerances for glassware. Table 1.2 gives the RSD values specified for certain items of grades A and B glassware.

Table 1.2 Manufacturers' tolerances on some items of glassware

Item of glassware	Grade A	Grade B
1 ml bulb pipette	± 0.7%	± 1.5%
5 ml bulb pipette	± 0.3%	± 0.6%
100 ml volumetric flask	± 0.08%	± 0.15%
500 ml volumetric flask	± 0.05%	± 0.1%
full 25 ml burette	± 0.2%	± 0.4%

An estimate of compound random errors is obtained from the square root of the sum of the squares of the RSDs attributed to each component or operation in the analysis. If the analysis of paracetamol described in Box 1.3 is considered then, assuming the items of glassware are used correctly. Assuming the items of glassware are used correctly the errors involved in the dilution steps can be simply estimated from the tolerances given for the pipette and volumetric flasks. The British Standards Institution (BS) tolerances for the grade A glassware used in the assay are as follows:

500 ml volumetric flask 500 ml \pm 0.05%

100 ml volumetric flask 100 ml \pm 0.08%

5 ml one mark pipette 5 ml \pm 0.3%

Standard deviation of error from glassware =

$$\sqrt{0.05^2 + 0.08^2 + 0.3^2} = \sqrt{0.0989} = 0.31\%$$

Thus it can be seen that the compound error from the glassware differs little from the largest error in the process. Of course the glassware errors can be eliminated by calibration of the glassware prior to use but in general analysts will accept manufacturers' tolerances. The tolerated random error from glassware could be readily eliminated; other random errors such as variation in the extraction efficiency are more difficult to control.

Self-test 1.3

Estimate the compound random error in the following assay with respect to the dilution steps described and calculate the error as SD of the w/v percentage of the injection assuming it is exactly 2% w/v.

A 2% w/v injection was diluted twice using grade A 5 ml bulb pipettes and grade A 100 ml volumetric flasks as follows:

Dilution 1: 5 to 100 ml

Dilution 2: 5 to 100 ml

The uncertainty in the spectrophotometric reading was \pm 0.2%.

Answer: \pm 0.48% and \pm 0.01% w/v

Reporting of results

In calculating an answer from the data obtained in an analysis it is important to not indicate a higher level of precision than was actually possible in the assay. As mentioned the previous section, when considering the accuracy of glassware used with the assumption that it complied with the BS grade A standard, it was obvious that there was some uncertainty in any figure $<$ 1%. It might be possible to improve on this degree of precision by calibrating glassware; however, any improvement in precision in the real world would take time and hence have cost implications. Thus for the purposes of most analyses, and for the purposes of the calculations in this book, it would seem sensible to report four significant figures, i.e. to 0.1%. In the process of carrying out calculations, five figures can be retained and rounded up to four figures at the end of the calculation. Since in pharmaceutical analyses the percentage of the stated content of a drug in a formulation may be reported as being between 90 and 99.9%, if the first significant figure is 9 then at the end of the calculation a more realistic estimate of precision is given by rounding the answer up to three significant figures. The SD or RSD reported with the answer should reflect

the number of significant figures given; since there is usually uncertainty in figures < 1% of the answer the RSD should not be reported to > 0.1%. Taking this into consideration the correct and incorrect ways of reporting some answers are given in Table 1.3.

Table 1.3 Significant figures in the reporting of analytical results

Answer \pm S Incorrect	RSD	Answer \pm S Correct	RSD
% of stated content = 99.2 \pm 0.22	0.22	% of stated content = 99.2 \pm 0.2	0.2
% of stated content = 101.15 \pm 0.35	0.35	% of stated content = 101.2 \pm 0.4	0.4
0.2534 \pm 0.00443% w/v	1.75	0.2534 \pm 0.0044% w/v	1.7
1.0051 \pm 0.0063% w/w	0.63	1.005 \pm 0.006% w/w	0.6
1.784 \pm 0.1242 μ g/ml	6.962	1.784 \pm 0.124 μ g/ml	7.0

Other terms used in analytical procedures control

Analytical blank

This consists of all the reagents or solvents used in an analysis without any of the analyte being present. A true analytical blank should reflect all the operations to which the analyte in a real sample is subjected. It is used for example in checking that reagents or indicators do not contribute to the volume of titrant required for a titration, including zeroing spectrophotometers or in checking for chromatographic interference.

Calibration

The calibration of a method involves comparison of the value or values of a particular parameter measured by the system under strictly defined conditions with pre-set standard values. Examples include: calibration of the wavelength and absorbance scales of a UV/visible spectrophotometer (Ch. 4), calibration of the wavelength scale of an IR spectrometer (Ch. 5) and construction of chromatographic calibration curves (Ch. 12).

Limit of detection

This is the smallest amount of an analyte which can be detected by a particular method. It is formally defined as follows:

$$x - x_B = 3s_B$$

Where x is the signal from the sample, x_B is the signal from the analytical blank and s_B is the SD of the reading for the analytical blank. In other words the criterion for a reading reflecting the presence of an analyte in a sample is that the difference between the reading taken and the reading for the blank should be three times the SD of the blank reading. The SD of the signal from the sample can be disregarded since the sample and the blank should have been prepared in the same manner so that it and the sample produce a similar SD in their readings. A true limit of detection should reflect all the processes to which the analyte in a real assay is subjected and not be a simple dilution of a pure standard for the analyte until it can no longer be detected.

Self-test 1.5

In which of the following cases has the limit of detection been reached?

Signal from sample	Sample SD	Signal from analytical blank	Analytical blank SD
1. Abs 0.0063	0.0003	0.0045	0.0003
2. Abs 0.0075	0.0017	0.0046	0.0018
3. 0.335 ng/ml	0.045 ng/ml	0.045 ng/ml	0.037 ng/ml

Answer 2

Linearity

Most analytical methods are based on processes where the method produces a response that is linear and which increases or decreases linearly with analyte concentration. The equation of a straight line takes the form:

$$y = a + bx$$

where a is the intercept of the straight line with the y axis and b is the slope of the line. Taking a simple example, a three-point calibration curve is constructed through readings of absorbance against procaine concentration (Table 1.4).

Table 1.4 Data used for the construction of a calibration curve for the spectrophotometric determination of procaine

Procaine concentration mg/100 ml	Absorbance reading
0.8	0.604
1.0	0.763
1.2	0.931

The best fit of a straight line through these values can be determined by determining a and b from the following equations:

$$b = \frac{\sum_i (x_i - \bar{x})(y_i - \bar{y})}{\sum_i (x_i - \bar{x})^2}$$

$$a = \bar{y} - b\bar{x}$$

where x_i are the individual values for x , \bar{x} is the mean value of x , y_i are the individual values for y and \bar{y} is the mean of y .

From the data in Table 1.3:

$$\bar{x} = \frac{0.8 + 1.0 + 1.2}{3} = 1.0$$

$$\bar{y} = \frac{0.604 + 0.763 + 0.931}{3} = 0.766$$

$$b = \frac{(0.8 - 1.0)(0.604 - 0.766) + (1.0 - 1.0)(0.763 - 0.766) + (1.2 - 1.0)(0.931 - 0.766)}{(0.8 - 1.0)^2 + (1.0 - 1.0)^2 + (1.2 - 1.0)^2}$$

$$= \frac{0.0324 + 0 + 0.033}{0.04 + 0.04} = 0.818$$

$$a = 0.766 - 0.818 \times 1.0 = -0.052$$

Thus the equation for the best fit is:

$$y = 0.818x - 0.052$$

The statistical measure of the goodness of fit of the line through the data is the correlation coefficient r . A correlation coefficient of > 0.99 is regarded as indicating linearity. The correlation coefficient is determined from the following equation:

$$r = \frac{\sum_i \{(x_i - \bar{x})(y_i - \bar{y})\}}{\sqrt{\sum_i [(x_i - \bar{x})^2] \sum_i [(y_i - \bar{y})^2]}}$$

Substituting the values from Table 1.3:

$$r = \frac{(0.8 - 1.0)(0.604 - 0.766) + (1.0 - 1.0)(0.763 - 0.766) + (1.2 - 1.0)(0.931 - 0.766)}{\sqrt{[(0.8 - 1.0)^2 + (1.0 - 1.0)^2 + (1.2 - 1.0)^2][(0.604 - 0.766)^2 + (0.763 - 0.766)^2 + (0.931 - 0.766)^2]}}$$

$$r = \frac{0.0324 + 0 + 0.033}{\sqrt{0.08 \times 0.0534}} = 1.00$$

Thus to three significant figures the straight line fit through the values in Table 1.3 is perfect. For a fuller treatment of the mathematical determination and significance of a correlation coefficient see reference 1. The equation for the correlation coefficient is very useful in that it can be applied to correlations between curves of any shape and thus it can be used for spectral comparisons such as those carried out between diode array spectra obtained during high-pressure liquid chromatography (Ch. 12 p. 251).

Range

The range of a method is related to its *sensitivity*, although there are methods such as immunoassays which are capable of measuring very small amounts of material, but are not very sensitive in that they measure over a restricted range of low concentration. Thus, some types of detection have very wide dynamic ranges and others may only function over a restricted range before *linearity* is lost. A UV detector has a dynamic range of about 1×10^3 and for a particular compound it might measure concentrations between 0.1 and 100 $\mu\text{g/ml}$. In contrast a flame photometer has a range not much greater than 1×10 . Sample concentrations must be adjusted so that they fall into the range of the equipment used to make the measurement.

Robustness

This term refers to how resistant the precision and accuracy of an assay is to small variations in the method, e.g. changes of instrumentation, slight variations in extraction procedures, sensitivity to minor impurities in reagents, etc. Robust assays may not be capable of the highest precision or specificity but they are regarded as fit for the purpose for which they are designed.

Selectivity

The selectivity of a method is a measure of how capable it is of measuring the analyte alone in the presence of other compounds contained in the sample. The most selective analytical methods involve a chromatographic separation. Detection methods can be ranked according to their selectivity. A simple comparison is

between fluorescence spectrophotometry and UV spectrophotometry; there are many more compounds which exhibit UV absorption than there are those which exhibit strong fluorescence, thus fluorescence spectrophotometry is a more selective method. Because selective methods are based on more complex principles than non-selective methods they may be less robust, e.g. fluorescence spectrophotometry is more affected by changes in the analytical method than UV spectrophotometry.

Sensitivity

The sensitivity of method indicates how responsive it is to a small change in the concentration of an analyte. It can be viewed as the slope on a response curve and may be a function of the method itself or of the way in which the instrumentation has been calibrated. In Figure 1.3 the method having a *linear* response $y = 2.5 \times$ is 5 times more sensitive than the method exhibiting a linear response $y = 0.5x$. Sensitivity and the *limit of detection* of a method are often confused. The limit of detection is due to a combination of *range* and *sensitivity*.

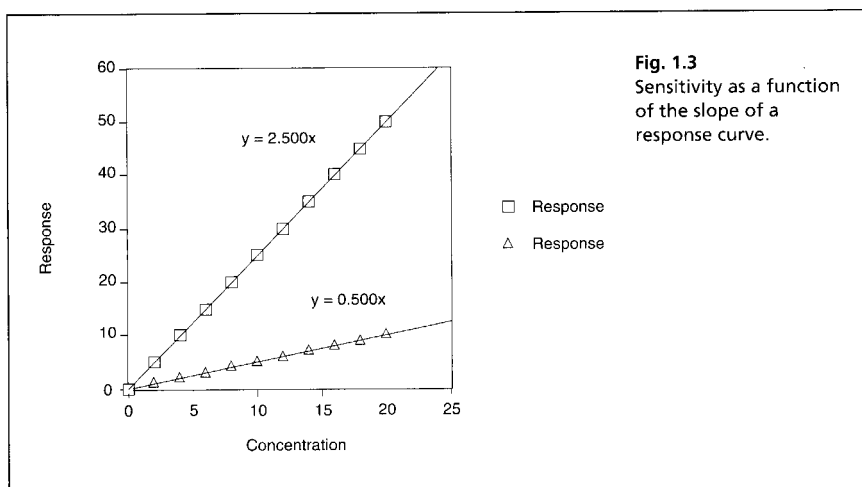

Weighing by difference

Weighing by difference is used to minimise weighing errors in an analytical procedure. The sample is weighed in a suitable vessel, e.g. a glass weighing boat with a spout, and then transferred immediately to the vessel in which it is going to be analysed or dissolved. The weighing vessel is then reweighed and the difference between the weights before and after transfer gives the weight of the sample. This method of weighing minimises errors due to, for example, the absorption of moisture onto the surface of the vessel. It also means that there is not a requirement for complete transfer of the sample that is to be analysed.

The points listed in Boxes 1.5 and 1.6 indicate how pharmaceutical preparations may come to be out of specification.

Box 1.5 Sources of impurities in pharmaceutical manufacture

- During the course of the manufacture of a pure drug substance, impurities may arise as follows:
 - (i) Present in the synthetic starting materials
 - (ii) Result from residual amounts of chemical intermediates used in the synthetic process and from unintended side reactions
 - (iii) Result from reagents, solvents and catalysts used in manufacture
- The process used to produce the formulated drug substance may introduce impurities as follows:
 - (i) Particulate matter from the atmosphere, machines and devices used in the manufacturing process and from containers
 - (ii) Impurities that are present in the excipients used in the formulation
 - (iii) Cross contamination may occur from other processes carried out using the same equipment, e.g. from mixers
 - (iv) Microbial contamination may occur
 - (v) The drug may react with the excipients used in the formulation
 - (vi) Impurities may be introduced from packaging, e.g. polymeric monomers.

Box 1.6 Processes leading to the deviation of the actual content from the stated content of a drug in a formulation

- Incomplete mixing of drug with formulation excipients prior to compression into tablets or filling into capsules
- Physical instability of the dosage form: tablets that disintegrate too readily; creams or suspensions that separate and over- or undercompression of tablets leading to deviation from the required weight
- Chemical breakdown of the drug resulting from its reaction with air, water, light, excipients in a formulation or with packaging materials
- Partitioning of the drug into packaging materials.

References

1. J.C. Miller and J.N. Miller. Statistics for Analytical Chemistry. 3rd Edn. Ellis Horwood (1993).

Physical and chemical properties of drug molecules

Introduction

Calculation of pH values of aqueous solutions of strong and weak acids and bases

Dissociation of water

Strong acids and bases

Weak acids and bases

Acidic and basic strength and pK_a

Henderson–Hasselbalch equation

Ionisation of drug molecules

Buffers

Salt hydrolysis

Activity, ionic strength and dielectric constant

Partition coefficient

Effect of pH on partitioning

Drug stability

Zero order degradation

First order degradation

Stereochemistry of drugs

Geometrical isomerism

Chirality and optical isomerism

Diastereoisomers

Measurement of optical rotation

Profiles of physico-chemical properties of some drug molecules

Procaine

Paracetamol

Aspirin

Benzylpenicillin

5-Fluorouracil

Acebutolol

Sulphadiazine

Isoprenaline

Prednisolone

Guanethidine

Pyridostigmine bromide

Additional problems

Introduction

The physical properties of organic molecules such as pK_a and partition coefficient are dealt with extensively in pharmacy courses^{1,2} but do not feature greatly in analytical chemistry courses. It is often surprising that analytical chemists cannot distinguish between, for instance, basic, weakly basic, acidic, weakly acidic and neutral nitrogen functions. The physical properties of drug molecules along with simple chemical derivatisation and degradation reactions play an important part in the design of analytical methods. Drug molecules can be complex, containing multiple functional groups that in combination produce the overall properties of the molecule. This chapter will serve as a starting point for understanding the chemical and physico-chemical behaviour of drug molecules that influence the development of analytical methods. The latter part of the chapter focuses on some typical drugs that are representative of a class of drug molecules and lists their physical properties and the properties of their functional groups in so far as they are known.

Calculation of pH value of aqueous solutions of strong and weak acids and bases

Dissociation of water

The pH of a solution is defined as $-\log [H^+]$, where $[H^+]$ is the concentration of hydrogen ions in solution.

In pure water the concentration of hydrogen ions is governed by the equilibrium:

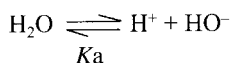

K_a is the dissociation constant for the equilibrium, is known as K_w in the case of the dissociation of water and is determined by the following expression:

$$K_w = \frac{[H^+][HO^-]}{[H_2O]} = [H^+][HO^-] = 10^{-14}$$

Since the concentration of water does not change appreciably as a result of ionisation its concentration can be regarded as not having an effect on the equilibrium and it can be omitted from the equation and this means that in pure water:

$$[H^+] = [HO^-] = 10^{-7}$$

The pH of water is thus given by $-\log 10^{-7} = 7.00$.

Strong acids and bases

If an acid is introduced into an aqueous solution the $[H^+]$ increases.

If the pH of an aqueous solution is known the $[H^+]$ is given by the expression 10^{-pH} , e.g., $[H^+]$ in pH 4 solution = 10^{-4} M = 0.0001 M. Since $[H^+][OH^-] = 10^{-14}$ for water the concentration of $[OH^-]$ in this solution is 10^{-10} M.

A strong acid is completely ionised in water and $[H^+]$ is equal to its molarity, e.g. 0.1 M HCl contains 0.1 M H^+ (10^{-1} M) and has a pH of $-\log 0.1 = 1$. For a solution of a strong base such as 0.1 M NaOH $[OH^-] = 0.1$ M and $[OH^-][H^+] = 10^{-14}$ therefore $[H^+] = 10^{-13}$ M and the pH of the solution = 13. Although the pH range is regarded as being between 0–14 it does extend above and below these values, e.g. 10 M HCl in theory has a pH of –1.

Self-test 2.1

Calculate the pH of the following solutions:

- (i) 0.05 M HCl
- (ii) 0.05 M NaOH
- (iii) 0.05 M H_2SO_4

Answers: (i) 1.3; (ii) 12.7; (iii) 1.0 since 0.05 M H_2SO_4 contains 0.1 M H^+

Weak acids and bases

Weak acids are not completely ionised in aqueous solution and are in equilibrium with the undissociated acid, as is the case for water, which is a very weak acid. The dissociation constant K_a is given by the expression below:

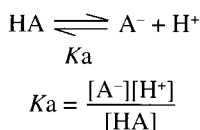

For instance in a 0.1 M solution of acetic acid ($K_a = 1.75 \times 10^{-5}$) the equilibrium can be written as follows:

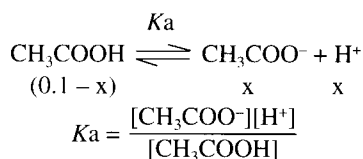

The pH can be calculated as follows:

$$1.75 \times 10^{-5} = \frac{x^2}{(0.1 - x)}$$

Since the dissociation of the acetic acid does not greatly change the concentration of the unionised acid the above expression can be approximated to:

$$1.75 \times 10^{-5} = \frac{x^2}{0.1}$$

$$x = [\text{H}^+] = \sqrt{1.75 \times 10^{-6}} = 0.00132 \text{ M}$$

$$\text{pH} = 2.9$$

In comparison the pH of 0.1 M HCl is 1.

The calculation of the pH of a weak base can be considered in the same way. For instance in a 0.1 M solution of ammonia ($K_b = 1.8 \times 10^{-5}$) the equilibrium can be written as follows:

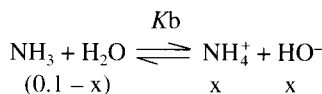

If the concentration/activity of water is regarded as being 1 then the equilibrium constant is given by the following expression:

$$K_b = \frac{[\text{NH}_4^+][\text{HO}^-]}{[\text{NH}_3]}$$

$$1.8 \times 10^{-5} = \frac{x^2}{(0.1 - x)}$$

The concentration of NH_3 can be regarded as being unchanged by a small amount of ionisation and the expression can be written as:

$$x = [\text{HO}^-] = \sqrt{1.8 \times 10^{-6}} = 0.0013 \text{ M}$$

$$[\text{H}^+] = \frac{K_w}{0.0013} = \frac{10^{-14}}{0.0013} = 7.7 \times 10^{-12} \text{ M}$$

$$\text{pH} = 11.1$$

In comparison the pH of 0.1 M NaOH is 13.

Self-test 2.2

Calculate the pH of the following solutions:

- (i) 0.1 M formic acid ($K_a = 1.77 \times 10^{-4}$)
 (ii) 0.05 M phenol ($K_a = 1.3 \times 10^{-10}$)
 (iii) 0.15 M ethylamine ($K_b = 5.6 \times 10^{-4}$)

Answers: (i) 2.4; (ii) 5.6; (iii) 11.9

Acidic and basic strength and pKa

The pKa value of a compound is defined as: $pK_a = -\log K_a$.

A pKa value can be assigned to both acids and bases.

For an acid, the higher the $[H^+]$ the stronger the acid, e.g.:

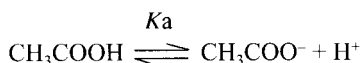

In the case of a base it is the protonated form of the base that acts as a proton donor, e.g.:

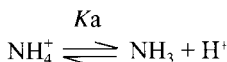

In this case the lower the $[H^+]$ the stronger the base.

If pKa is used as a measure of acidic or basic strength *for an acid, the smaller the pKa value the stronger the acid* for a base *the larger the pKa value the stronger the base*.

Henderson–Hasselbalch equation

$$K_a = \frac{[A^-][H^+]}{[HA]}$$

Can be rearranged substituting pH for $-\log [H^+]$ and pKa for $-\log K_a$ to give:

$$pH = pK_a + \log \frac{[A^-]}{[HA]}$$

For example when acetic acid (pKa 4.76) is in solution at pH 4.76. The Henderson–Hasselbalch equation can be written as follows:

$$pH = 4.76 + \log \frac{[CH_3COO^-]}{[CH_3COOH]}$$

From this relationship for acetic acid it is possible to determine the degree of ionisation of acetic acid at a given pH.

Thus when the pH = 4.76, then:

$$4.76 = 4.76 + \log \frac{[CH_3COO^-]}{[CH_3COOH]}$$

$$\log \frac{[CH_3COO^-]}{[CH_3COOH]} = 0$$

$$\frac{[CH_3COO^-]}{[CH_3COOH]} = 10^0 = 1$$

Self-test 2.3

Determine the percentage of ionisation of acetic acid at (i) pH 3.76 and (ii) 5.76.

Answers: (i) 96.06% (ii) 0.06%

Acetic acid is 50% ionised at pH 4.76. In the case of a weak acid it is the protonated form of the acid that is un-ionised and as the pH falls the acid becomes less ionised.

For a base the Henderson-Hasselbalch equation is written as follows:

$$\text{BH}^+ \rightleftharpoons \text{B} + \text{H}^+$$

$$\text{pH} = \text{pK}_a + \log \frac{[\text{B}]}{[\text{BH}^+]}$$

For example when ammonia (pK_a 9.25) is in a solution at pH 9.25 Henderson-Hasselbalch equation can be written as follows:

$$9.25 = 9.25 + \log \frac{[\text{NH}_3]}{[\text{NH}_4^+]}$$

$$\log \frac{[\text{NH}_3]}{[\text{NH}_4^+]} = 0$$

$$\frac{[\text{NH}_3]}{[\text{NH}_4^+]} = 10^0 = 1$$

Ammonia is 50% ionised at pH 9.25. In this case it is the protonated form of the base that is ionised and as the pH falls the base becomes more ionised.

Self-test 2.4

Calculate the percentage of ionisation of ammonia at (i) pH 8.25 and (ii) pH 10.25.

Answers: (i) 96.06% (ii) 0.06%

An alternative way of writing the expression giving the percentage of ionisation for an acid or base of a particular pK_a value at a particular pH value is:

$$\text{Acid: \% ionisation} = \frac{10^{\text{pH} - \text{pK}_a}}{1 + 10^{\text{pH} - \text{pK}_a}} \times 100$$

$$\text{Base: \% ionisation} = \frac{10^{\text{pK}_a - \text{pH}}}{1 + 10^{\text{pK}_a - \text{pH}}} \times 100$$

Ionisation of drug molecules

The ionisation of drug molecules is important with regard to their absorption into the circulation and their distribution to different tissues within the body. The pK_a value of a drug is also important with regard to its formulation into a medicine and to the design of analytical methods for its determination.

Calculation example 2.1

Calculate the percentage of ionisation of the drugs shown in Figure 2.1 at pH 7.0

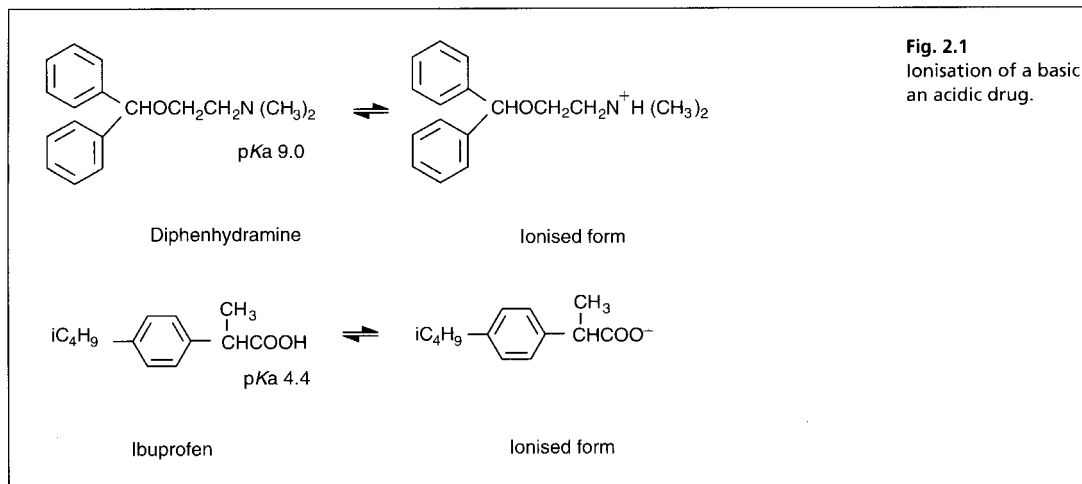
**Diphenhydramine**

This drug contains one basic nitrogen and at pH 7.0 its percentage of ionisation can be calculated as follows:

$$\begin{aligned} \% \text{ Ionisation diphenhydramine} &= \frac{10^{9.0-7.0}}{1 + 10^{9.0-7.0}} \times 100 \\ &= \frac{10^{2.0}}{1 + 10^{2.0}} \times 100 = \frac{100}{101} \times 100 = 99.0\% \end{aligned}$$

Ibuprofen

This drug contains one acidic group and at pH 7.0 its percentage of ionisation can be calculated as follows:

$$\begin{aligned} \text{percentage of ionisation of ibuprofen} &= \frac{10^{7.0-4.4}}{1 + 10^{7.0-4.4}} \times 100 \\ &= \frac{10^{2.6}}{1 + 10^{2.6}} \times 100 = \frac{398}{399} \times 100 = 99.8\% \end{aligned}$$

Self-test 2.5

Calculate the percentage of ionisation of the following drugs, which contain 1 group, which ionises in the pH range 0–14 at the pH values of (i) 4 and (ii) 9.

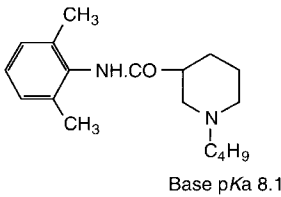

Bupivacaine

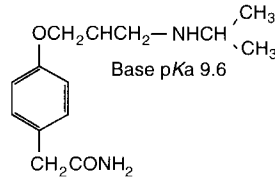

Atenolol

Acidic drugs

Acidic drugs

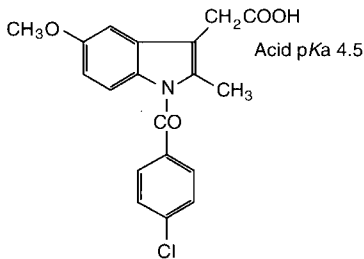

Indomethacin

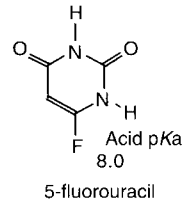

5-fluorouracil

Answers: Bupivacaine (i) 99.99%, (ii) 11.2%; Atenolol (i) 99.99%, (ii) 79.9%; Indomethacin (i) 24.0%, (ii) 99.99%; 5-fluorouracil (i) 0.01%, (ii) 90.9%

Buffers

Buffers are used in a number of areas of analytical chemistry such as the preparation of mobile phases for chromatography and the extraction of drugs from aqueous solution. The simplest type of buffer is composed of a weak acid or base in combination with a strong base or acid. A common buffer system is the sodium acetate/acetic acid buffer system. The most direct way of preparing this buffer is by the addition of sodium hydroxide to a solution of acetic acid until the required pH is reached. The most effective range for a buffer is 1 pH unit either side of the pKa value of the weak acid or base used in the buffer. The pKa value of acetic acid is 4.76 thus its effective buffer range is 3.76–5.76.

Calculation example 2.2

1 litre of 0.1 M sodium acetate buffer with a pH 4.0 is required. Molecular weight of acetic acid = 60 therefore 1 litre of 0.1 M buffer there will be 6 g of acetic acid. To prepare the buffer 6 g of acetic acid are weighed and made up to ca 500 ml with water. The pH of the acetic acid solution is adjusted to 4.0 by addition of 2 M sodium hydroxide solution using a pH meter to monitor the pH. The solution is then made up to 1 litre with water. Calculate the concentration of acetate and acetic acid in the buffer at pH 4.0.

Using the Henderson–Hasselbalch equation:

$$4.00 = 4.76 + \log \frac{[\text{CH}_3\text{COO}^-]}{[\text{CH}_3\text{COOH}]}$$

$$\log \frac{[\text{CH}_3\text{COO}^-]}{[\text{CH}_3\text{COOH}]} = -0.76$$

$$\frac{[\text{CH}_3\text{COO}^-]}{[\text{CH}_3\text{COOH}]} = \frac{10^{-0.76}}{1} = \frac{0.17}{1}$$

The buffer is composed of 1 part acetic acid and 0.17 part acetate.

The buffer was prepared from 0.1 moles of acetic acid, after adjustment to pH 4.0 the amounts of acetic acid and acetate present are as follows:

$$\text{CH}_3\text{COOH} = \frac{1}{1.17} \times 0.1 \text{ moles} = 0.085 \text{ moles}$$

$$\text{CH}_3\text{COO}^- = \frac{0.17}{1.17} \times 0.1 \text{ moles} = 0.015 \text{ moles}$$

Since the acetic acid and acetate are dissolved in 1 litre of water, the buffer is composed of 0.085 M CH_3COOH and 0.015 M CH_3COO^- . Although the concentrations of acetate and acetic acid vary with pH such a buffer can be known as a 0.1 M sodium acetate buffer.

Note: The 0.1 M buffer should not be prepared by adding acetic acid to a solution of 0.1 M NaOH since a large amount of acetic acid would be required to adjust the pH to 4.0; in fact 0.1 moles of NaOH would require 0.57 moles of acetic acid to produce a buffer with pH 4.0 and a strength of 0.57 M.

An alternative way of producing 1 litre of 0.1 M acetate buffer would be to mix 850 ml of a 0.1 M solution of acetic acid with 150 ml of a 0.1 M solution of sodium acetate.

Self-test 2.6

1 litre of a 0.1 M ammonium chloride buffer with a pH of 9.0 is required. Ammonia has a pKa value of 9.25. If a precise molarity is required this buffer is best prepared from ammonium chloride. The pH of the ammonium chloride may be adjusted to pH 9.0 by addition of a solution of sodium hydroxide (assuming the presence of sodium is not a problem). A total of 5.35 g (0.1 moles) of ammonium chloride are weighed and dissolved in ca 500 ml of water. The pH is then adjusted to pH 9.0 by addition of 5M NaOH. The solution is then made up to 1 litre with water.

Calculate the concentrations of NH_4^+ and NH_3 in the buffer at pH 9.0 and indicate an alternative method for preparing the buffer.

In this case:

$$\text{pH} = \text{pKa} + \log \frac{[\text{NH}_3]}{[\text{NH}_4^+]}$$

Answer: 0.036 M NH_3 and 0.064 M NH_4^+ . The buffer could be prepared by mixing 360 ml of a 0.1 M ammonia solution with 640 ml of 0.1 M NH_4Cl .

Some weak acids and bases have more than one buffer range, for example phosphoric acid has three ionisable protons with three different pK_a values and can be used to prepare buffers to cover three different pH ranges. The ionic species involved in the ranges covered by phosphate buffer are:

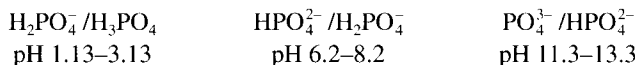

The buffering ranges of a weak electrolyte are only discrete if the pK_a values of its acidic and/or basic groups are separated by more than 2 pH units. Some acids have ionisable groups with pK_a values less than 2 pH units apart so that they produce buffers with wide ranges. For example, succinic acid, which has pK_a values of 4.19 and 5.57, can be considered to have a continuous buffering range between pH 3.19 and 6.57.

Self-test 2.7

Determine the buffer range(s) for the following compounds:

- (i) Carbonic acid pK_a 6.38, 10.32
- (ii) Boric acid pK_a 9.14, 12.74
- (iii) Glycine 2.34, 9.60
- (iv) Citric acid 3.06, 4.74, 5.4.

Answers: (i) 5.38–7.38, 9.32–11.32. The lower range is not useful because of the ease with which CO_2 is lost from solution; (ii) 8.14–10.14, 11.74–13.74; (iii) Glycine: 1.34–3.34, 8.6–10.6; (iv) Citric acid: Continuous buffering range 2.06–6.4

Sometimes a salt of a weak acid with weak base is used in a chromatographic mobile phase to, apparently, set the pH at a defined level, e.g. ammonium acetate or ammonium carbonate. These salts are marginally more effective than a salt of strong acid with a strong base at preventing a change in pH but they are not truly buffers. Such salts have buffering ranges *ca* 1 pH unit either side of the pK_a values of the weak acid and weak base composing them. For example the pH of a solution ammonium acetate is *ca* 7.0 but it does not function effectively as a buffer unless the pH either rises to *ca* 8.25 or falls to *ca* 5.76.

A buffer is most effective where its molarity is greater than the molarity of the acid or base it is buffering against.

Calculation example 12.3

If 10 ml of 0.05 M HCl are added to 100 ml of 0.2 M sodium acetate buffer pH 4.5 the resultant pH can be calculated as follows:

Molarity \times volume = mmoles

Number of mmoles of acetate + acetic acid in 100 ml of buffer = $0.2 \times 100 = 20$ mmoles.

Using the Henderson–Hasselbalch equation:

$$4.5 = 4.76 + \log \frac{[\text{CH}_3\text{COO}^-]}{[\text{CH}_3\text{COOH}]}$$

$$\log \frac{[\text{CH}_3\text{COO}^-]}{[\text{CH}_3\text{COOH}]} = -0.26$$

$$\frac{[\text{CH}_3\text{COO}^-]}{[\text{CH}_3\text{COOH}]} = \frac{10^{-0.26}}{1} = \frac{0.55}{1}$$

The buffer contains 1 part CH_3COOH and 0.55 parts CH_3COO^- .
 $\text{CH}_3\text{COOH} = \frac{1}{1.55} \times 20 = 12.9$ mmoles $\text{CH}_3\text{COO}^- = \frac{0.55}{1.55} \times 20 = 7.1$ mmoles

When HCl is added the following reaction occurs:



The amount of HCl added is $10 \times 0.05 = 0.5$ mmoles

Therefore after addition of HCl

The amount of acetate remaining is:

$$7.1 - 0.5 = 6.6 \text{ mmoles}$$

The amount of acetic acid now present is:

$$12.9 + 0.5 = 13.4 \text{ mmoles}$$

Therefore the pH of the buffer after addition of HCl is determined as follows (amounts may be substituted in the equation instead of concentrations since CH_3COO^- and CH_3COOH are present in the same volume):

$$\text{pH} = 4.76 + \log \frac{6.6}{13.4} = 4.76 - 0.31 = 4.45$$

The new pH of the buffer is 4.45.

The molarity of the buffer has also changed since the total amount of CH_3COO^- and CH_3COOH is now contained in 110 ml instead of 100 ml giving a new molarity of $0.2 \times \frac{100}{110} = 0.182 \text{ M}$

If 10 ml of 0.05 M HCl were added to 100 ml of water the pH would be determined as follows:

$$-\log \left(0.05 \times \frac{10}{110} \right) = 2.34$$

Self-test 2.8

10 ml of 0.1 M HCl are added to 20 ml of a 0.5 M sodium acetate buffer with a pH of 4.3. Calculate: the pH of the buffer after addition of the HCl, the molarity of the buffer after addition of the HCl, the resultant pH if the HCl had been added to 20 ml of water.

Answer: pH = 4.04, new molarity = 0.33. Addition of 10 ml of 0.1 M HCl to 20 ml of water would give a pH of 1.48

Salt hydrolysis

When the salt of a strong acid and a strong base is dissolved in water it produces a pH of ca 7.0. When salts of a weak acid and a strong base or of a strong acid and a weak base are dissolved in water they will produce respectively alkaline and acidic solutions.

When sodium acetate is dissolved in water the acetate ion behaves as a base removing protons from solution. For a weak electrolyte in water $K_b \times K_a = K_w$. If a 0.1 M solution of sodium acetate in water is considered:

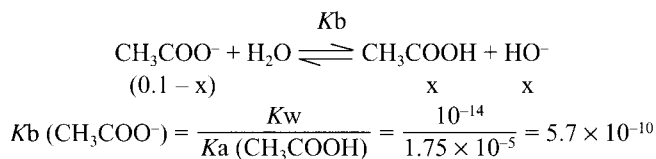

Regarding the change in the concentration of water as not affecting the equilibrium and regarding the $[\text{CH}_3\text{COO}^-]$ as being relatively unchanged by hydrolysis.

$$5.7 \times 10^{-10} = \frac{x^2}{0.1}$$

$$[\text{HO}^-] = \sqrt{5.7 \times 10^{-11}} = 7.6 \times 10^{-6}$$

$$[\text{H}^+] = \frac{10^{-14}}{7.6 \times 10^{-6}} = 1.33 \times 10^{-9}$$

$$\text{pH} = 8.9$$

Self-test 2.9

Calculate the pH of a 0.1 M solution of NH_4Cl . Here salt hydrolysis increases $[\text{H}^+]$ and the equilibrium in this case is:

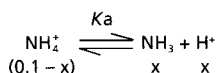

The K_a for this reaction is 5.6×10^{-10} .

Answer: pH = 5.13

Activity, ionic strength and dielectric constant

The activity of ions in a solution is governed by the dielectric constant of the medium they are dissolved in and by the total concentration of ions in solution. For solutions of electrolytes in water with concentrations < 0.5 M the activity of the ions present in solution is usually approximated to their individual concentrations. The mean activity coefficient for an ion in solution is defined as:

$$\gamma_{\pm} = \frac{\text{activity}}{\text{concentration}}$$

Although activity is regarded as 1 in dilute solutions this is still an approximation. The activity of an electrolyte solution in water can be estimated from the following equation:

$$\log \gamma_{\pm} = -0.509 (z_+ z_-) \sqrt{I}$$

$$\text{where } I = \frac{1}{2} \sum m_i z_i^2$$

where -0.509 is a constant related to the dielectric constant of the solvent used to prepare the electrolyte solution and to temperature, z is the charge on a particular ion, I is the ionic strength of the solution and m is the molality (moles per kg of solvent) of a particular ion in solution.

Using this equation the activity of H^+ in 0.1 M HCl can be calculated to be 0.69. Thus the true pH of 0.1 M HCl is calculated as follows:

$$\text{pH} = -\log 0.1 \times 0.69 = 1.2$$

This slight difference between the pH determined from activity and from concentration is usually ignored. However, from the equation used to calculate the activity coefficient it can be seen that the activity decreases with decreasing ionic strength. In addition the constant (-0.509 for water) increases with decreasing

dielectric constant, e.g. water has a dielectric constant of 78.5 and methanol a dielectric constant of 32.6. Addition of methanol to an aqueous solution of an acid or buffer will cause an increase in the pH of the solution through decreasing the activity of all of the ions in solution including H^+ . This effect should be noted with regard to the preparation of high-pressure liquid chromatography (HPLC) mobile phases which are often composed of mixtures of buffers and organic solvents. Ionic strength is important with regard to the preparation of running buffers for capillary electrophoresis where the greater the ionic strength of the buffer the higher the current through the capillary (Ch. 14).

Partition coefficient

An understanding of partition coefficient and the effect of pH on partition coefficient is useful in relation to the extraction and chromatography of drugs. The partition coefficient for a compound (P) can be simply defined as follows:

$$P = \frac{C_o}{C_w}$$

where C_o is the concentration of the substance in an organic phase and C_w is the concentration of the substance in water.

The greater P the more a substance has an affinity for organic media. The value of P for a given substance of course depends on the particular organic solvent used to make the measurement. Many measurements have been made of partitioning between n-octanol and water since n-octanol, to some extent, resembles biological membranes and is also quite a good model for reverse-phase chromatographic partitioning. P is often quoted as a log P -value, e.g. a log P of 1 is equivalent to $P = 10$. Where $P = 10$ for a particular compound partitioning into a particular organic solvent, and partitioning is carried out between equal volumes of the organic solvent and water, then ten parts of the compound will be present in the organic layer for each part present in the water layer.

Calculation example 2.4

A neutral compound has a partition coefficient of 5 between ether and water. What percentage of the compound would be extracted from 10 ml of water if (i) 30 ml of ether were used to extract the compound or (ii) three 10 ml volumes of ether were used in succession to extract the compound?

(i) Between water and an equal volume of ether 5 parts of the drug would be in the ether layer compared with 1 part in the water layer. Where 3 volumes (30 ml) of ether were used to 1 volume (10 ml) of water the distribution would be 15 parts of drug in the ether layer to 1 part in the water layer.

$$\text{Percentage extracted} = \frac{15}{16} \times 100 = 93.75\%$$

(ii) First extraction

5 parts in the ether layer and 1 part in the water layer (total six parts)

At each extraction $\frac{5}{6}$ of the material in the water layer is extracted.

$$\text{Percentage extracted} = \frac{5}{6} \times 100 = 83.3\%$$

Percentage of drug remaining in water layer = 16.7%

Second extraction

$\frac{5}{6}$ of the 16.7% remaining in the water layer is extracted.

$$\text{Percentage extracted} = \frac{5}{6} \times 16.7 = 13.9\%$$

Percentage of drug remaining in water layer = 2.8%

Third extraction

$\frac{5}{6}$ of the 2.8% remaining in the water layer is extracted.

$$\text{Percentage extracted} = \frac{5}{6} \times 2.8 = 2.3\%$$

Percentage of drug remaining in water layer = 0.5%

Total percentage of drug extracted = 83.3 + 13.9 + 2.3 = 99.5%

Self-test 2.10

A drug has a partition coefficient of 12 between chloroform and water. Calculate the percentage of a drug that would be extracted from 10 ml of water with (i) 30 ml of chloroform; (ii) 3 × 10 ml of chloroform.

Answers: (i) 97.3%; (ii) 99.95%

Effect of pH on partitioning

Many drugs contain ionisable groups and their partition coefficient at a given pH may be difficult to predict if more than one ionised group is involved. However, often one group in a molecule may be much more ionised than another at a particular pH thus governing its partitioning. It is possible to derive from the Henderson–Hasselbalch equation expressions for the variation in the partitioning of organic acids and bases into organic solvent with respect to the pH of the solution that they are dissolved in.

From the Henderson–Hasselbalch equation:

$$\text{For acids: } P_{\text{app}} = \frac{P}{1 + 10^{\text{pH} - \text{pK}_a}}$$

$$\text{For bases: } P_{\text{app}} = \frac{P}{1 + 10^{\text{pK}_a - \text{pH}}}$$

P_{app} is the apparent partition coefficient that varies with pH. Thus it can be seen when a compound, acid or base, is 50% ionised (i.e. $\text{pH} = \text{pK}_a$) its partition coefficient is half that of the drug in the un-ionised state:

$$P_{\text{app}} = \frac{P}{1 + 10^0} = \frac{P}{2}$$

As a general rule for the efficient extraction of a base into an organic medium from an aqueous medium the pK_a of the aqueous medium should be at least 1 pH unit higher than the pK_a value of the base and in the same situation for an acid the pH should be 1 pH unit lower than the pK_a value of the acid.

Calculation example 2.5

A linctus formulation contains the following components:

Base A pKa 6.7, P (chloroform/0.1 M NaOH) = 100	5 mg/ml
Base B pKa 9.7, P (chloroform/0.1 M NaOH) = 10	30 mg/ml
Benzoic acid pKa 4.2 P (chloroform /0.1 M HCl) = 50	5 mg/ml

In order to selectively extract base A 5 ml of the linctus is mixed with 15 ml of phosphate buffer pH 6.7 and extracted once with 60 ml of chloroform.

Calculate the percentage and the weight of each component extracted.

Base A

At pH 6.7:

$$P_{app} = 100/1 + 10^{6.7-6.7} = 100/2 = 50$$

If 20 ml of aqueous buffer phase were extracted with 20 ml of chloroform there would be 1 part of the base in the aqueous phase to 50 parts in the chloroform layer. Since 60 ml of chloroform are used in the extraction there will be 1 part of the base remaining in the aqueous phase and 150 parts in the chloroform layer.

Percentage extracted = $150/151 \times 100 = 99.3\%$

Base A is present at 5 mg/ml in the elixir.

Amount of base A in 5 ml of elixir = $5 \times 5 \text{ mg} = 25 \text{ mg}$

Amount of base A extracted = $25 \times 150/151 = 24.8 \text{ mg}$

Base B

At pH 6.7:

$$P_{app} = 10/1 + 10^{9.7-6.7} = 10/1001 = 0.01$$

If 20 ml of aqueous buffer phase were extracted with 20 ml of chloroform there would be 1 part of the base in the aqueous phase to 0.01 parts in the chloroform layer. Since 60 ml of chloroform are used in the extraction then

1 part of the base will remain in the aqueous phase while there will be 0.03 parts in the chloroform layer.

Percentage extracted = $0.03/1.03 \times 100 = 3.0\%$

Base B is present at 30 mg/ml in the elixir

Amount of base B in 5 ml of elixir = $5 \times 30 \text{ mg} = 150 \text{ mg}$

Amount of base B extracted = $0.03 \times 150 = 4.5 \text{ mg}$

Benzoic acid

At pH 6.7 for an acid:

$$P_{app} = 50/1 + 10^{6.7-4.2} = 50/317 = 0.158$$

If 20 ml of aqueous buffer phase were extracted with 20 ml of chloroform there would be 1 part of the preservative in the aqueous phase to 0.158 parts in the chloroform layer. Since 60 ml of chloroform are used in the extraction

1 part of the benzoic acid will remain in the aqueous phase while there will be 0.474 parts in the chloroform layer.

Percentage extracted = $0.474/1.474 \times 100 = 32.2\%$

Benzoic is present at 5 mg/ml in the elixir

Amount of benzoic acid in 5 ml of elixir = $5 \times 5 \text{ mg} = 25 \text{ mg}$

Amount of benzoic acid extracted = $0.474/1.474 \times 25 = 8.0 \text{ mg}$

The extract is not completely free of the other ingredients in the formulation. If back extraction of the extract with an equal volume of pH 7.7 buffer is carried out approximately 1% of extracted base A will be removed but the amount of base B and benzoic acid will be reduced to < 0.5 mg.

Self-test 2.11

A cough mixture contains the following components:

- | | |
|---|------------|
| (i) Base 1 pKa = 9.0, P (CHCl ₃ /0.1 M NaOH) = 1000 | 30 mg/5 ml |
| (ii) Base 2 pKa = 9.7, P (CHCl ₃ /0.1 M NaOH) = 10 | 30 mg/5 ml |
| (iii) Acidic preservative pKa 4.3 P (CHCl ₃ /0.1 M HCl) = 10 | 5 mg/5 ml |

5 ml of the cough mixture is mixed with 15 ml of phosphate buffer pH 7.0 and extracted with 60 ml of chloroform. Calculate the weight of each component extracted.

Answers: (i) Base 1 29.0 mg; (ii) Base 2 1.69 mg; (iii) Preservative 0.28 mg

Drug stability

Many drugs are quite stable but functional groups such as esters and lactam rings which occur in some drugs are susceptible to hydrolysis and functional groups such as catechols and phenols are quite readily oxidised. The most common types of degradation which occur in pure and formulated drugs obey zero or first order kinetics.

Zero order degradation

In zero order kinetics the rate of degradation is independent of the concentration of the reactants. Thus if the rate constant for the zero order degradation of a substance is 0.01 moles h⁻¹ then after 10 h 0.1 moles of the substance will have degraded. This type of degradation is typical of hydrolysis of drugs in suspensions or in tablets where the drug is initially in the solid state and gradually dissolves at more or less the same rate as the drug in solution is degraded, i.e. the equilibrium concentration in free solution remains constant.

First order degradation

First order kinetics of drug degradation has been widely studied. This type of degradation would be typical of the hydrolysis of a drug in solution. Such reactions are pseudo first order since the concentration of water is usually in such large excess that it is regarded as constant even though it does participate in the reaction. In first order kinetics the rate constant k has the units h⁻¹ or s⁻¹ and the rate of the reaction for a drug is governed by the expression:

$$-\frac{d[A]}{dt} = k[A]$$

where A is the concentration of the drug which will change as degradation proceeds. This expression can be written as:

$$\frac{dx}{dt} = k(a - x)$$

which can also be written as

$$\int_0^x \frac{dx}{(a-x)} = \int_0^t k dt$$

where x is the amount of degraded product and a is the starting concentration of the drug. From this expression by integration and rearrangement the following expression arises:

$$t = \frac{1}{k} \ln \frac{a}{a-x}$$

The half-life of the drug (the time taken for 50% of a sample drug to degrade, i.e. where x is $a/2$) is thus given by the following expression:

$$t_{0.5} = \frac{1}{k} \ln \frac{a}{a/2} = \frac{1}{k} \ln 2$$

Thus for aspirin, which has a rate constant of 0.0133 h^{-1} for the hydrolysis of its ester group at 25° and pH 7.0, the half-life can be calculated as follows:

$$t_{0.5} = \frac{0.693}{0.0133} = 52.1 \text{ h}$$

The shelf-life of a drug, the time required for 10% degradation (where x is $0.1 a$), is given by the following expression:

$$t_{0.9} = \frac{1}{k} \ln \frac{a}{0.9a} = \frac{1}{k} \ln 1.11$$

Calculation example 2.6

In a high-pressure liquid chromatography assay of aspirin tablets, 10 extracts are made and the extracts are diluted with mobile phase solution, which consists of acetonitrile/0.1 M sodium acetate buffer pH 4.5 (10:90) and analysed sequentially. If the rate constant for the degradation of aspirin in the mobile phase is 0.0101 h^{-1} at room temperature how long can the analyst store the solutions at room temperature before the degradation of the analyte is greater than 0.5%?

In this case we are interested in $t_{(0.995)}$: \ln

$$t_{(0.995)} = \frac{(a/0.995a)}{0.0101} = 0.5 \text{ h}$$

Thus in order for degradation to be $< 0.5\%$ the solutions would have to be analysed within 30 min of their being prepared.

Self-test 2.12

Determine the half-lives of the following drugs, which can undergo hydrolysis of their ester functions in solution, under the conditions specified.

- Atropine at 40°C and pH 7.0 where $k = 2.27 \times 10^{-4} \text{ h}^{-1}$.
- Procaine at 37°C and pH 8.0 where $k = 1.04 \times 10^{-2} \text{ h}^{-1}$.
- Benzocaine at 30°C and pH 9.0 where $k = 2.27 \times 10^{-3} \text{ h}^{-1}$.

Answers: (i) 127.2 d; (ii) 66.6 h; (iii) 12.7 d

Stereochemistry of drugs

The physiological properties of a drug are governed to a great extent by its stereochemistry. In recent years it has emerged that, in some instances, even optical isomers of a drug can have very different physiological effects. Since

stereochemistry is concerned with the way in which a drug is orientated in space this is something that is difficult to visualise on a flat piece of paper and the assignment of absolute configuration to a drug some people find confusing. The three types of isomerism encountered in drug molecules are geometrical isomerism, optical isomerism and diastereoisomerism.

Geometrical isomerism

Drugs which have a geometrical isomer are relatively uncommon.

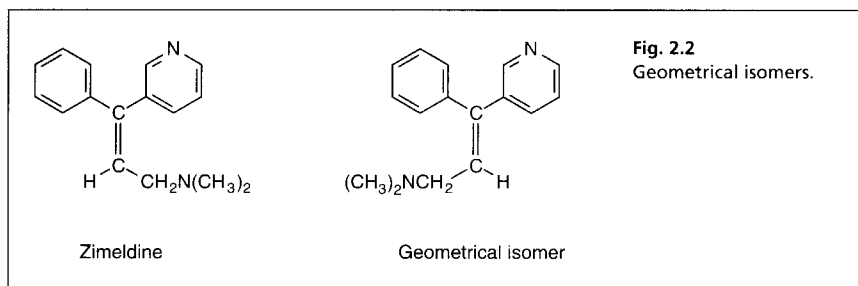

An example of a drug with a geometrical isomer is the antidepressant zimeldine (Fig. 2.2). The lack of free rotation about the double bond ensures that the stereochemistry of this drug and its isomer is different. Zimeldine is the only drug used. Other drugs which could also have geometric isomers of this type include amitriptyline and triprolidine.

Chirality and optical isomerism

Optical isomerism of drug molecules is widespread. Many drug molecules only contain one or two chiral centres. A simple example is the naturally occurring neurotransmitter adrenaline. When a compound has no symmetry about a particular carbon atom the carbon atom is said to be a chiral centre. When a compound contains one or more chiral centres it is able to rotate plane-polarised light to the right (+) or the left (-). A chiral centre arises when a carbon atom has four structurally different groups attached to it.

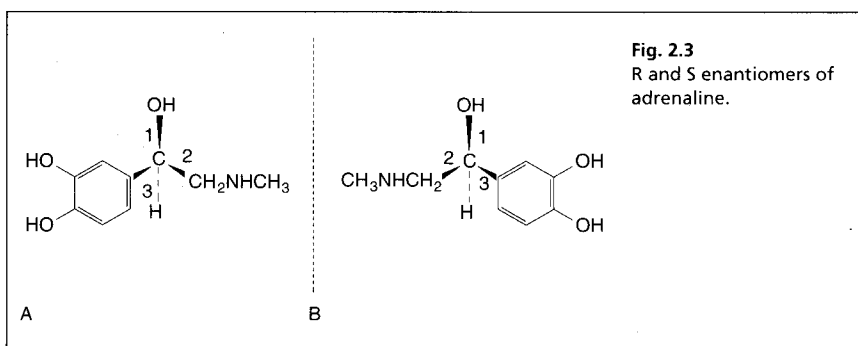

Adrenaline can exist as two enantiomers that are mirror images of each other (Fig. 2.3) and are thus non-superimposable. In Figure 2.3 the wedge-shaped bonds indicate bonds above the plane of the paper, the dotted bonds indicate bonds pointing

down into the paper and unbroken lines indicate bonds in the same plane as the paper. In common with all pairs of enantiomers, the adrenaline enantiomers have identical physical and chemical properties, the only difference in their properties is that the enantiomers rotate plane-polarised light in opposite directions. However, the two enantiomers of adrenaline do have different biological properties, the (–) enantiomer exerts a much stronger effect, for instance, in increasing heart rate. It is not possible simply by looking at a structure drawn on paper to say which way it will rotate plane-polarised light – this can only be determined by experiment. In order to describe the configuration about a chiral centre a set of precedence rules was developed:

- (i) The group of lowest priority attached to the chiral carbon, often hydrogen, is placed behind the plane of the paper with all the other groups pointing forwards.
- (ii) The priorities are assigned to the atoms immediately attached to the chiral centre in order of decreasing atomic mass. For example:

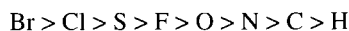

- (iii) If two atoms attached to the chiral centre are of the same precedence the priority is assigned on the basis of the atoms attached to these atoms, for example:

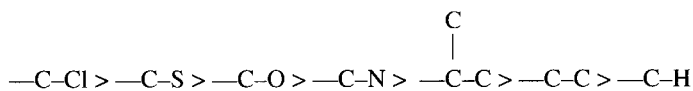

- (iv) If required the third atom in a chain may be considered, for example:



Using these rules we can assign the absolute configurations for adrenaline structures A and B. Placing the group of lowest priority behind the paper, in this case H.

For structure A we find moving in a clockwise direction (clockwise = *R*):

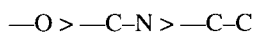

Thus the absolute configuration of A is *R* and it follows that its mirror image B must be *S* (the order of precedence moves anti-clockwise).

To relate the (+) (dextrorotatory) and (–) (laevorotatory) forms of a molecule to an absolute (*R* or *S*) configuration is complex and requires preparation of a crystal of the compound suitable for analysis by X-ray crystallography. In contrast the direction in which a molecule rotates plane-polarised light is easily determined using a polarimeter.

X-ray crystallography of the enantiomers of adrenaline has shown that the (–) form has the *R* configuration and the (+) form has *S* configuration.

It should be noted that in older literature the terms *d* and *l* are used to denote (+) and (–) respectively and *D* and *L* are used to denote *R* and *S* respectively. A mixture containing equal amounts of (+) and (–) adrenaline or indeed enantiomers of any drug is known as a racemic mixture and of course will not rotate plane-polarised light. The physical separation of enantiomers in a racemic mixture into their pure (+) and (–) forms is often technically difficult.

Ampicillin (Fig. 2.4) provides a more complex example than adrenaline with regard to assignment of absolute configuration since it contains four chiral centres.

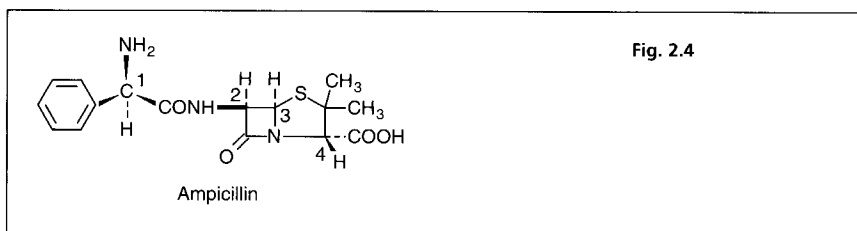

Assignment can be made as follows:

Chiral centre 1:

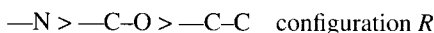

Chiral centre 2:

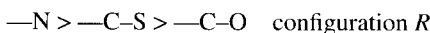

Chiral centre 3:



Chiral centre 4:

In this case since the molecule is drawn with the hydrogen pointing forward it is best to determine the configuration from the molecule as drawn and then assign the opposite configuration.

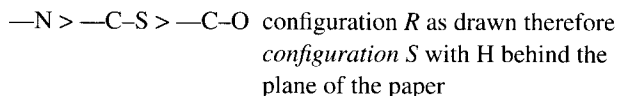

The structures of drugs as drawn on paper do not always lend themselves to ready assignment of absolute configuration and sometimes a certain amount of thinking in three dimensions is required in order to draw the structures in a form where the absolute configuration can be assigned. In drugs such as steroids, penicillins and morphine alkaloids, which are all based on natural products, chirality is built into the molecules as a result of the action of the stereoselective enzymes present in the plant or micro-organism producing them. However, there are many synthetic drugs where chiral centres are part of the structure. Many of these drugs are used in the form of racemates since there are technical difficulties in carrying out stereospecific chemical synthesis or in resolving mixtures of enantiomers resulting from non-stereoselective synthesis. In the past many such racemic mixtures have been used as drugs without regard for the fact that effectively a drug that is only 50% pure is being administered. The so called 'inactive' enantiomer may in fact be antagonistic to the active form or it may have different physiological effects.^{3,4} The most notable example, which gave rise to much of the medicines legislation in the past 30 years, is the case of thalidomide, which contains one chiral centre and was administered as a racemate in order to alleviate morning sickness during pregnancy. The active enantiomer produced the intended therapeutic effects whilst the 'inactive' enantiomer was responsible for producing birth defects in the children of mothers who took the racemic drug. Current legislation requires a manufacturer seeking to license a new drug in the form of a racemate to justify the use of the racemate as opposed to a pure enantiomer.

Self-test 2.13

Assign absolute configurations to the chiral centres in the following drugs.

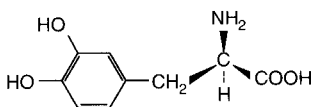

(-) DOPA

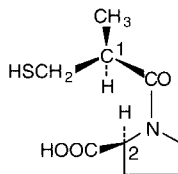

Captopril

Answers: R (-) DOPA; captopril 1S 2S

Diastereoisomers

Where more than one chiral centre is present in a molecule there is the possibility of diastereoisomers, e.g. captopril. Another example of a synthetic drug with two chiral centres is labetalol. The number of diastereoisomers arising from n chiral centres is 2^{n-1} , i.e. 2 in the case of labetalol. In the structure shown in Figure 2.5 chiral centres 1 and 2 in structure A have the configurations R and S respectively; the enantiomer of this structure (B) has the S and R configurations in centres 1 and 2. In addition there is a pair of enantiomers C and D that are diastereoisomers of the structures A and B, which have the configurations $1R2R$ and $1S2S$.

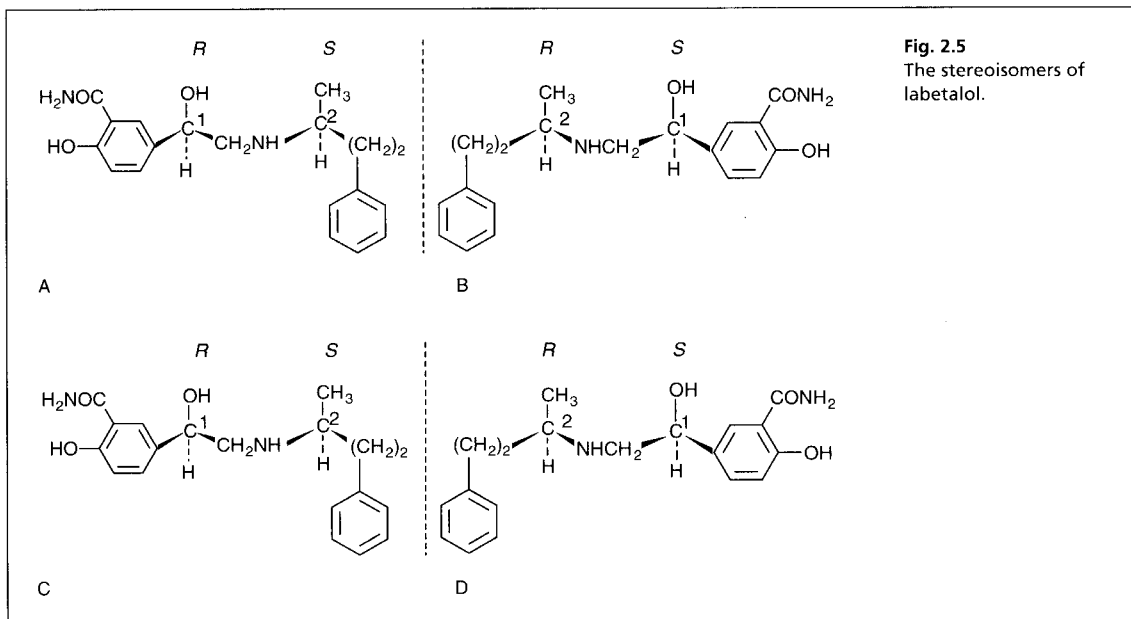

Fig. 2.5
The stereoisomers of labetalol.

The diastereoisomers in a mixture can be usually separated by ordinary chromatographic methods. In the case of labetalol, two peaks would be seen in a chromatographic trace obtained from a non-chiral phase – one due to the $1R2S$, $1S,2R$ pair of enantiomers and the other to the $1R,2R$ and $1S,2S$ pair of enantiomers.

The commercial drug is in fact administered as a mixture of all four isomers and the BP monograph for labetalol checks the ratio of the two chromatographic peaks produced by the two enantiomeric pairs of diastereoisomers. In order to separate the enantiomeric pairs a chiral chromatography column would be required and separation on a chiral column produces four peaks (Ch. 12).

Self-test 2.14

Indicate the configuration of the pairs of enantiomeric diastereoisomers which compose the drug isoxsuprine.

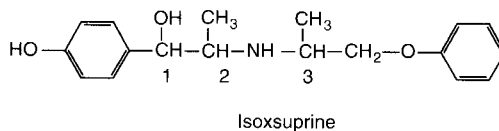

Answer: 1R 2R 3R and 1S 2S 3S; 1R 2R 3S and 1S 2S 3R; 1R 2R 3R and 1S 2S 3S; 1R 2R 3S and 1S 2S 3R and 1R 2S 3R and 1S 2R 3S

An example of a pair of diastereoisomers used separately as drugs is betamethasone and dexamethasone shown in Figure 2.6. With a total of eight chiral centres within the betamethasone and dexamethasone structures there is the possibility $2^8 = 64$ isomers of the structure and these divide into 32 enantiomeric pairs. Both dexamethasone and betamethasone could have corresponding enzymes, their optical isomers do not exist. Semi-synthetic steroids are largely derived via microbial fermentation from naturally occurring plant sterols, originally obtained from the Mexican yam. The partially degraded natural products are then subjected to a number of chemical synthetic steps to produce the required steroid.

Fig. 2.6
An example of diastereoisomers used separately as drug molecules.

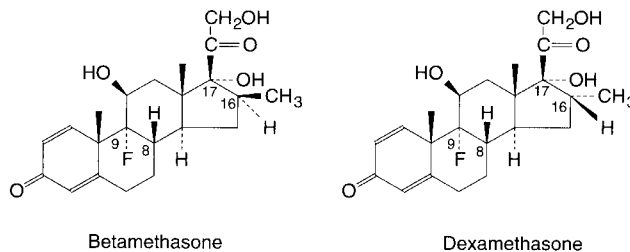

In betamethasone and dexamethasone the only stereoisomerism is at the synthetically substituted 16 position. In the case of betamethasone the methyl group is in the β -position, i.e. as one looks down on the molecule, it is closer than the hydrogen at position 16 (not necessarily projecting vertically out of the plane of the paper). In dexamethasone, the methyl group is in the α -position – further away than the hydrogen at 16 (not necessarily projecting vertically down into the paper). Of the two steroids betamethasone has the slightly stronger anti-inflammatory potency. Another stereochemical term is *cis* and *trans* and this refers to the relative orientation of two substituents. In betamethasone the hydroxyl group at 17 and the

methyl group at 16 are trans – on opposite sides of the ring; in dexamethasone the hydroxyl group at 17 and the methyl group at 16 are cis – on the same side of the ring. Otherwise the relative orientation of the substituents is the same in both drugs, e.g. fluorine at 9 and hydrogen at 8 are trans to each other.

Measurement of optical rotation

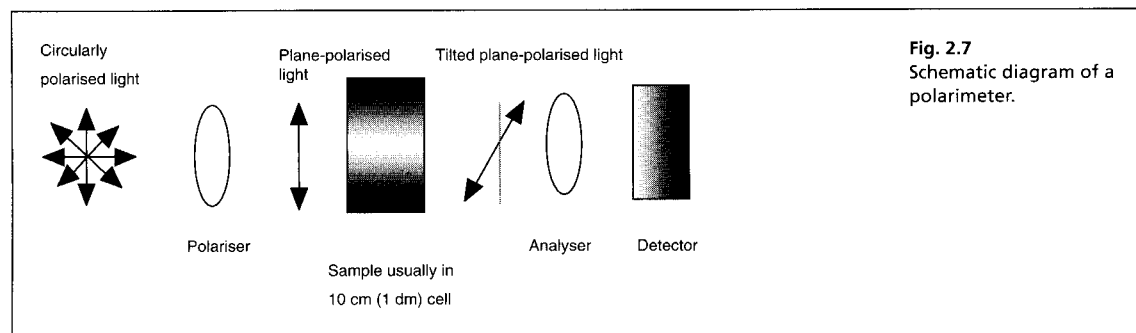

Fig. 2.7
Schematic diagram of a polarimeter.

Figure 2.7 shows a schematic diagram of a polarimeter. Light can be viewed as normally oscillating throughout 360° at 90° to its direction of travel. The light source is usually a sodium lamp, the polarising material can be a crystal of Iceland spar, a Nicol prism or a polymeric material such as polaroid. When circularly polarised light is passed through the polariser its oscillations are confined to one plane. In the absence of an optically active material the instrument is set so that no light is able to pass through the analyser. When the polarised light is passed through an optically active medium the plane in which the light is oscillating in becomes tilted and light is able to pass through the analyser. The angle of rotation can be measured by correcting for the tilt by rotating the analyser until light again does not pass through it. The angle that the second polariser has to be rotated through to, once again, prevent the passage of light through it gives the measured rotation α . The standard value for the rotation produced by an optically active compound is $[\alpha]$ the specific rotation of a substance where:

$$[\alpha] = \frac{100\alpha}{lc}$$

where α is the measured rotation, l is the pathlength of the cell in which the measurement is made in dm and c is the concentration of the sample solution in g/100 ml.

The observed optical rotation is dependent on both the wavelength of the light and the temperature. The sodium D line (589 nm) is usually used to make measurements. The solvent in which the sample is dissolved may also greatly affect the $[\alpha]$ of a substance. Values for $[\alpha]$ are usually quoted with details of the concentration of the solution used for measurement, the solvent, the temperature and the type of light used. For example the specific rotation for (–) adrenaline is given as:

$$[\alpha]^{25D} = -51^\circ (c = 2, 0.5 \text{ M HCl})$$

The optical rotation was obtained at 25° using the sodium D line with a 2 g 100 ml^{-1} solution in 0.5 M HCl.

If an enantiomer is chemically pure it is possible to determine its degree of enantiomeric purity by measuring its optical rotation relative to a standard value, e.g. if an enantiomeric mixture contains 1% of enantiomer A and 99% of enantiomer B $[\alpha]$ will be reduced by 2% compared to the value for optically pure B. Examples of the measurement of optical rotation as a quality control check are found in the BP monographs for Timolol maleate, Tobramycin and Phenylephrine Hydrochloride.

Self-test 2.15

Optical rotation measurements were made using the sodium D line at 25°C in a 1 dm cell and the readings obtained were as follows:

- (i) Phenylephrine HCl 2.6% w/v in 0.1 M HCl $\alpha = -0.98^\circ$
 (ii) Timolol maleate 9.8% w/v in 1 M HCl; $\alpha = -0.59$

Calculate $[\alpha]$ for these drugs and express it in the conventional form.

Answers: (i) $[\alpha]_{25}^D = -37.7^\circ$ (2.6, 0.1 M HCl); (ii) $[\alpha]_{25}^D = -6.02^\circ$ (9.8, 1 M HCl)

Profiles of physico-chemical properties of some drug molecules

Procaine

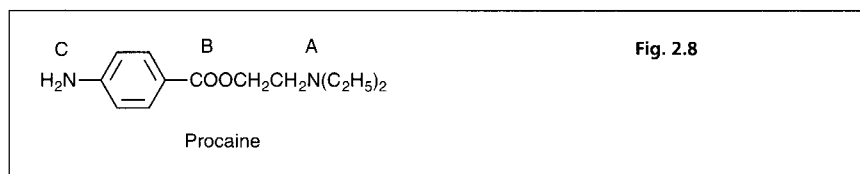

Drug type: local anaesthetic.

Functional groups:

- A Tertiary aliphatic amine, pK_a 9.0.
- B Ester, neutral.
- C Aromatic amine, very weak base pK_a ca 2.

Half-life in water: 26 d at pH 7.0, 37°C.

Additional information: Procaine is formulated in injections and thus susceptible to aqueous phase hydrolysis, in simple solution its degradation is first order (Fig. 2.9).

Fig. 2.9
Hydrolysis of procaine.

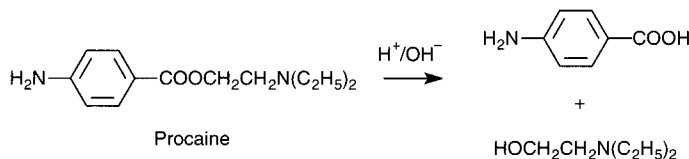

Self-test 2.16

Calculate:

- The percentage ionisation of procaine at pH 7.0 (the ionisation of group C at this pH will be negligible).
- The rate constant for its hydrolysis at pH 7.0 and 37°C.

Answers: (i) 99.01%; (ii) $1.11 \times 10^3 \text{ h}^{-1}$

Closely related drug molecules: Proxymetacaine, benzocaine, amethocaine, butacaine, propoxycaine, procainamide (for stability of an amide group see paracetamol), bupivacaine, lignocaine, prilocaine.

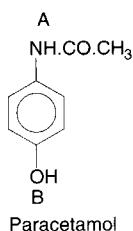
Paracetamol**Fig. 2.10**

Drug type: Analgesic.

Functional groups:

- A Amide group, neutral.
- B Phenolic hydroxy group very weak acid pK_a 9.5.

Half-life in water: 21.8 years at pH 6 and 25°C. Most amides are very stable to hydrolysis (Fig. 2.11).

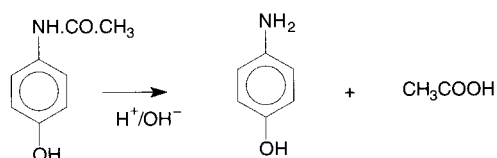
**Fig. 2.11**
Hydrolysis of paracetamol.

Other drugs containing an amide group: Bupivacaine, procainamide, lignocaine, beclamide, acebutolol.

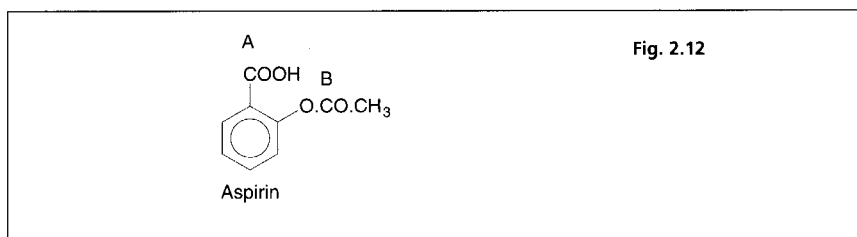

Aspirin

Drug type: Analgesic.

Functional groups:

- A Carboxylic acid, weak acid, pKa 3.5.
- B Phenolic ester, particularly unstable.

Half-life in water: 52 h at pH 7.0 and 25°C; ca 40 days at pH 2.5 and 25°C.

Additional information: The rate of HO⁻ catalysed hydrolysis of esters is > the rate of H⁺ hydrolysis of esters. Solid aspirin absorbs water from the atmosphere and then hydrolyses (Fig. 2.13).

Fig. 2.13
Hydrolysis of aspirin.

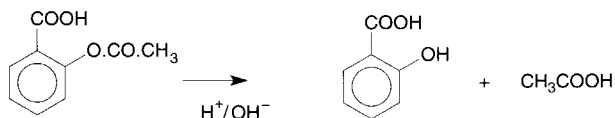

Partition coefficient of un-ionised compound at acidic pH: Octanol/water ca 631.

Other drugs containing phenolic ester group: metipranolol, vitamin E, benorylate, dipivefrin.

Benzylpenicillin

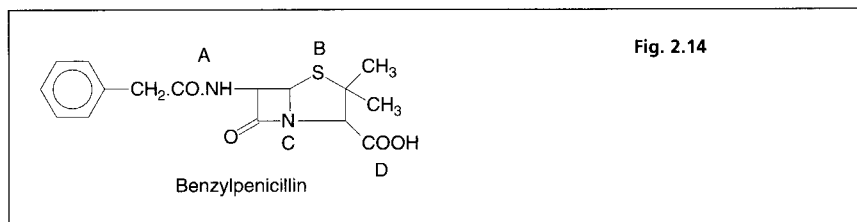

Drug type: antibiotic.

Functional groups:

- A Amide, neutral, relatively stable, see paracetamol.
- B Thioether, neutral, can be oxidised at high levels of oxygen stress.
- C Lactam ring, neutral, particularly susceptible to hydrolysis (Fig. 2.15).

Fig. 2.15
Hydrolysis of
benzylpenicillin.

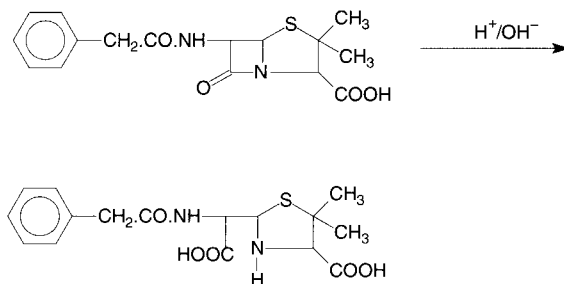

Half-life: benzylpenicillin: 38 d at pH 6.75 and 30°; ampicillin: 39 d at pH 6.5 and 25°.
Additional information: Consideration of the stability of these compounds is particularly important since they may be formulated as oral suspensions.

- D Carboxylic acid, weak acid pK_a 2.8 (the strength of the acid is increased by the adjacent lactam ring).

Compounds with similar properties: amoxicillin, cloxacillin, carbenicillin, flucloxacillin, phenoxymethylpenicillin, cephalixin, cefuroxime.

5-Fluorouracil

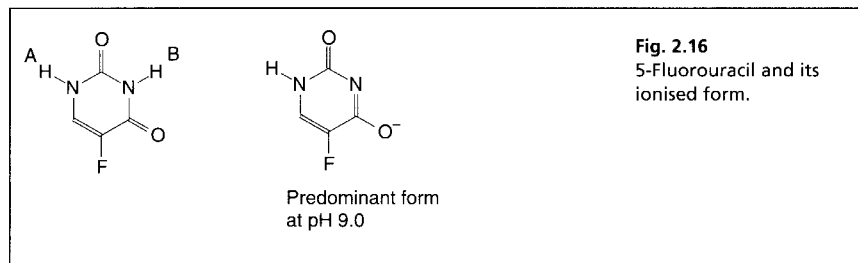

Drug type: anticancer

Functional groups:

- A Ureide nitrogen, acidic, pK_a 7.0.
- B Ureide nitrogen, very weakly acidic, pK_a 13.0.

Additional information: The molecule is quite stable.

Partition coefficient of un-ionised molecule: Octanol/water *ca* 0.13.

Compounds containing an acidic nitrogen in a heterocyclic ring: phenobarbitone, amylobarbitone, butobarbitone, bemegride, uracil, phenytoin, theophylline, theobromine.

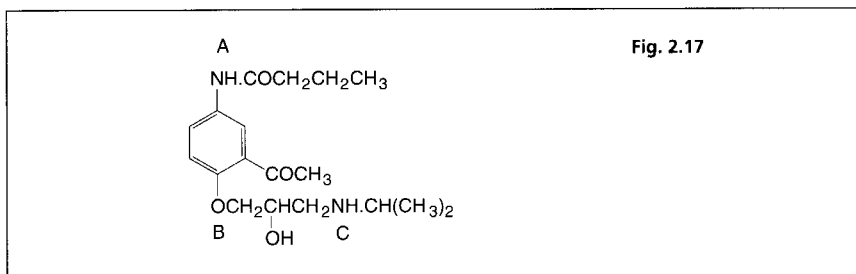

Acebutolol

Drug type: β -adrenergic blocker.

Functional groups:

- A Amide, neutral, susceptible to hydrolysis under strongly acidic conditions (see paracetamol).
- B Aromatic ether group, potentially oxidisable under stress conditions.
- C Secondary amine group pK_a 9.4.

Partition coefficient of un-ionised compound: Octanol/water *ca* 483.

Sulphadiazine

Fig. 2.18
Sulphadiazine and its
ionised form.

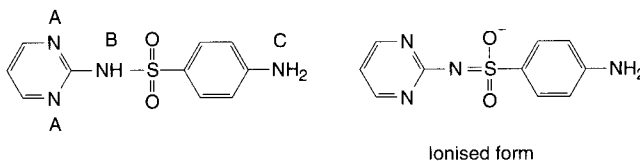

Drug type: antibacterial (Fig. 2.18).

Functional groups:

- A Diazine ring nitrogens, very weakly basic $pK_a < 2$.
- B Sulphonamide nitrogen, weak acid, pK_a 6.5.
- C Weakly basic aromatic amine $pK_a < 2$.

Partition coefficient of un-ionised compound: Octanol/water *ca* 0.55 (log P octanol water at pH 7.5 = -1.3).

Closely related compounds: sulphadoxine, sulphamerazine, sulphametopyrazine, sulphaquinoxaline, sulphachloropyridazine, sulphamethoxazole, sulphathiazole.

Self-test 2.17

Calculate the % ionisation of sulphadiazine at pH 7.5.

Answer: 90.9%. The weakly basic groups in the molecule are not ionised to any degree at pH 7.5

Isoprenaline

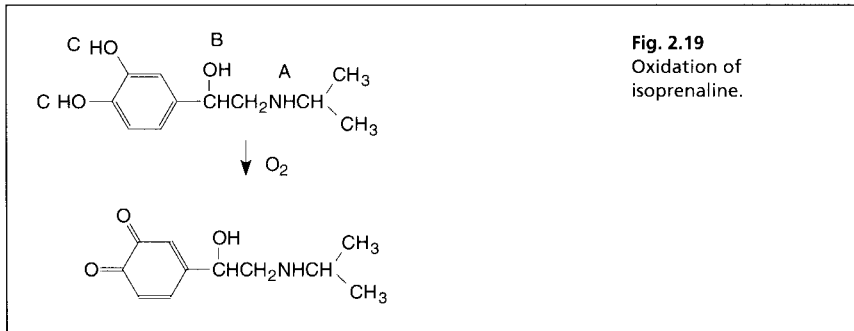

Drug type: sympathomimetic (Fig. 2.19).

Functional groups:

- A Secondary amine, base pK_a 8.6.
- B Benzyl alcohol group, neutral.
- C Catechol group, weakly acidic pK_a values *ca* 10 and 12.

Additional information: As indicated in the reaction above, the catechol group is very readily oxidised upon exposure to light or air. Oxidation results in such compounds turning brown, solutions of isoprenaline and related compounds must contain antioxidants as preservatives.

Partition coefficient of the un-ionised drug: The compound is highly water soluble and cannot be extracted to any great extent into an organic solvent since it is ionised to some extent at all pH values.

Closely related compounds: Dopamine, adrenaline, noradrenaline, terbutaline, DOPA.

Prednisolone

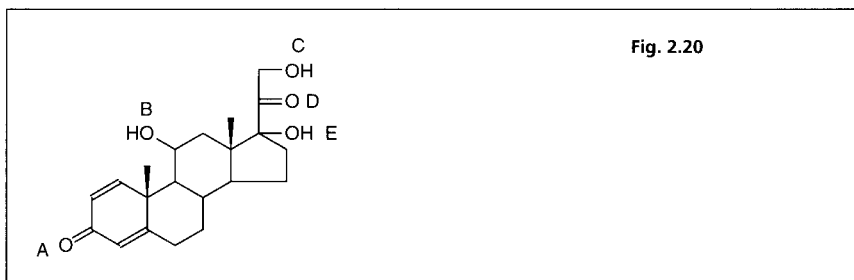

Drug type: corticosteroid (Fig. 2.20).

Functional groups:

- A and D ketone groups neutral.
- B and C secondary and primary alcohol groups, neutral.
- E Tertiary alcohol group, neutral, prone to elimination by dehydration at high temperatures. Where the hydroxyl group at E is converted to an ester such as valerate, e.g. betamethasone valerate, thermal elimination of the ester can occur quite readily. Another decomposition reaction of the valerate esters is the

intramolecular transfer of the ester group from E to C (see the BP tests for Betamethasone Valerate products).

Partition coefficient: Octanol/water *ca* 70. The drug does not ionise so that the partition coefficient is unaffected by pH. Despite being neutral compound the hydroxyl groups in prednisolone give it a water solubility of *ca* 0.5 mg/ml.

Closely related compounds: dexamethasone, betamethasone, triamcinolone, hydrocortisone, betamethasone valerate, betamethasone dipropionate.

Guanethidine

Fig. 2.21
Guanethidine and its ionised form.

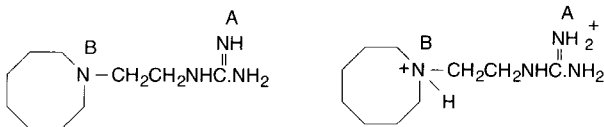

Predominant form of guanethidine at pH 7.0; charge on A is delocalised over all three nitrogens

Drug type: anti-hypertensive (Fig. 2.21).

Functional groups:

- A Guanidine group; one of the strongest nitrogen bases pK_a 11.4.
- B Tertiary amine pK_a 8.3.

Compounds containing guanidine group: arginine, creatinine, bethanidine, streptomycin, phenformin, metformin, chlorhexidine.

Pyridostigmine bromide

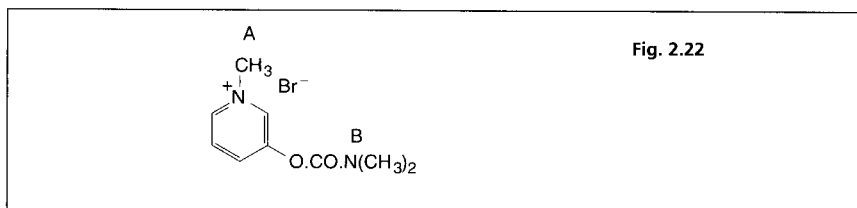

Fig. 2.22

Drug type: anti-cholinergic.

Functional groups:

- A Salt of strongly basic quaternary ammonium ion. Quaternary ammonium ions are charged at all pH values.
- B Carbamate group, the nitrogen is neutral as in an amide but the carbamate group is less stable than an amide having a stability similar to that of a phenolic ester.

Compounds containing a quaternary ammonium group: atracarium besylate, bretylium tosylate, clindium bromide, glycopyrronium bromide.

Additional problems

1. Calculate the pH of the following solutions assuming that the concentration and the activity of the solutions are the same:

- (i) 0.05 M HCl.
- (ii) 0.1 M chloroacetic acid ($K_a = 1.4 \times 10^{-3}$).
- (iii) 0.1 M phosphoric acid (First $K_a = 7.5 \times 10^{-3}$).
- (iv) 0.1 M fumaric acid ($K_a = 9.3 \times 10^{-4}$ and 3.4×10^{-5}).
- (v) 0.1 M di-isopropylamine base ($K_b = 9.09 \times 10^{-4}$).
- (vi) 0.1 M imidazole base ($K_b = 1.6 \times 10^{-7}$).

Answers: (i) 1.3; (ii) 1.93; (iii) 1.93; (iv) 1.94; (v) 1.56; (vi) 10.1

2. Calculate the pH of the following salt solutions:

- (i) 0.1 M sodium formate (K_a formic acid = 1.77×10^{-4})
- (ii) 0.1 M sodium fusidate (K_a fusidic acid = 4.0×10^{-6}).
- (iii) 0.1 M ephedrine hydrochloride (K_a of ephedrine = 2.5×10^{-10}).

Answers: (i) 8.4; (ii) 9.2; (iii) 5.3

3. Calculate what volumes of the salt solutions specified which would be required to prepare 1 l of the following buffers:

- (i) 0.1 M phosphoric acid/0.1 M sodium dihydrogen phosphate pH 2.5 (pK_a $H_2PO_4^-$ 2.13)
- (ii) 0.1 M sodium dihydrogen phosphate/0.1 M disodium hydrogen phosphate pH 8.0 (pK_a $H_2PO_4^-$ 7.21).
- (iii) 0.1 M sodium bicarbonate/0.1 M sodium carbonate pH 9.5 (pK_a HCO_3^- 10.32).

Answers: (i) 299 ml/701 ml; (ii) 139.5 ml/860.5 ml; (iii) 131.5 ml/868.5 ml

4. Indicate the percentage of ionisation of the functional groups specified in the following drugs at pH 7.0 (Fig. 2.23).

Fig. 2.23

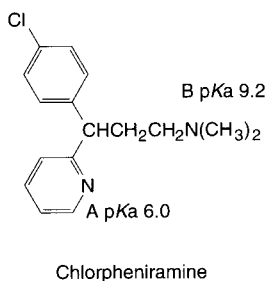
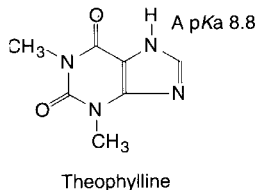

Answers: theophylline 1.56% (acidic nitrogen); chlorpheniramine A 9.09% B 99.4%

5. Calculate the percentage of the following compounds that would be extracted under the conditions specified:

- (i) A solution of basic drug pKa 9.2 in an oral liquid is mixed with a buffer having a pH of 7.2 and is extracted with an equal volume of chloroform (the partition coefficient of the un-ionised base into chloroform is 500).
- (ii) an acidic drug with a pKa 4.2 is extracted from a solution of pH 4.5 with an equal volume of chloroform (the partition coefficient of the un-ionised acid into chloroform is 300).

Answers: (i) 83.2%; (ii) 99.0%

6. Extracts containing benzylpenicillin were prepared for analysis in buffer at pH 6.5 at 25°C, the rate constant for the hydrolysis of benzylpenicillin under these conditions is 1.7×10^{-7} s. What is the maximum length of time the solutions can be stored before analysis so that no more than 1% decomposition occurs.

Answers: 16.4 h

7. Determine the absolute configurations of the chiral centres in menthol and phenbutazate. List the configurations of the pairs of enantiomeric diastereoisomers of menthol (Fig. 2.24).

Fig. 2.24

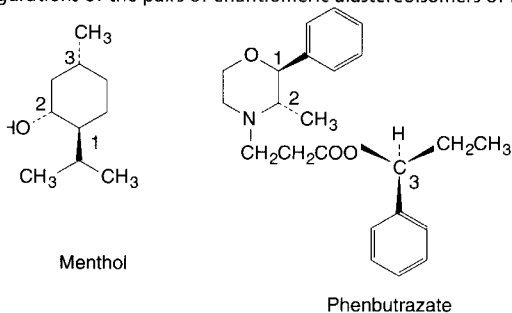

Answers: Menthol 1S 2R 3R; Phenbutazate 1S 2S 3S
Menthol: 1S 2R 3R/1R 2S 2S; 1S 2S 3R/1R 2R 3S; 1S 2S 3S/1R 2R 3R; 1S 2R 3S/1R 2S 3R.
Phenbutazate as for menthol.

References

1. J.B. Stenlake. Foundations of Molecular Pharmacology. Athlone Press (1979).
2. A.T. Florence and D. Attwood. Physicochemical Principles of Pharmacy. 2nd Edn, Macmillan Press (1988).
3. E.J. Ariens. Trends Pharmacol. Sci. 7, 200–205 (1986).
4. P.A. Lehmann. Trends Pharmacol. Sci. 7, 281–285 (1986).

3

Titrimetric and chemical analysis methods

Keypoints

Introduction

Instrumentation and reagents

Glassware

Primary standards and standard solutions

Direct acid/base titrations in the aqueous phase

Strong acid/strong base titrations

Weak acid/strong base and weak base/strong acid titrations

Indirect titrations in the aqueous phase

Estimation of esters by back titration

Saponification value

Estimation of alcohols and hydroxyl values by reaction with acetic anhydride (AA)

Non-aqueous titrations

Theory

Non-aqueous titration of weak bases

Non-aqueous titration of weak acids

Argentimetric titrations

Compleximetric titrations

Redox titrations

Theory

Iodometric titrations

Direct titrations

Iodine displacement titrations

Iodine-absorbing substances in penicillins

Ion pair titrations

Titration using indicator dyes

Titration using iodide as a lipophilic anion

Diazotisation titrations

Potentiometric titrations

Potentiometric end-point detection

Use of potentiometric titration to determine pKa values

Karl Fischer titration (coulometric end-point detection)

Automation of wet chemical methods

Automatic titration

Flow injection analysis

Applications of FIA in pharmaceutical analysis

Determination of chlorzoxine

Determination of captopril

Determination of non-steroidal anti-inflammatory drugs

Determination of promethazine

Determination of chlorocresol

Limit test for heavy metals

Use of segmented flow in determination of partition coefficients

Automated dissolution testing

KEYPOINTS

Principles

An analyte is chemically reacted with a standard solution of a reagent of precisely known concentration or with a concentration that can be precisely determined. The amount of a standard solution required to completely react with all of the sample is used to estimate the purity of the sample.

Applications

- Provide standard pharmacopoeial methods for the assay of unformulated drugs and excipients and some formulated drugs, e.g. those that lack a strong chromophore.
- Used for standardisations of raw materials and intermediates used in drug synthesis in industry. Suppliers of raw materials may provide these materials at a specified purity which has been assayed titrimetrically to a pharmacopoeial standard.
- Certain specialist titrations, such as the Karl Fischer titration used to estimate water content, are widely used in the pharmaceutical industry.

Advantages

- Capable of a higher degree of precision and accuracy than instrumental methods of analysis with precisions of $ca \pm 0.1\%$ being achievable.
- The methods are generally robust.
- Analyses can be automated.
- Cheap to perform and do not require specialised apparatus.
- They are absolute methods and are not dependent on the calibration of an instrument.

Limitations

- Non-selective.
- Time-consuming if not automated and require a greater level of operator skill than routine instrumental methods.
- Require large amounts of sample and reagents.
- Reactions of standard solutions with the analyte should be rapid and complete.

Introduction

Titrimetric methods are still widely used in pharmaceutical analysis because of their robustness, cheapness and capability for high precision. The only requirement of an analytical method that they lack is specificity. This chapter covers the theoretical basis of most of the commonly used methods; the practical aspects of titrations have been covered thoroughly by other textbooks.^{1,2}

Instrumentation and reagents

Glassware

The manufacturers' tolerances for the volumes of a number of items of glassware are given in Chapter 1. The larger the volume measure the smaller the percentage the tolerance is of the nominal volume. Thus for a Grade A 1 ml pipette the volume is within $\pm 0.7\%$ of the nominal volume whereas for the 5 ml pipette the volume is within $\pm 0.3\%$ of the nominal volume. If greater accuracy than those guaranteed by the tolerances is required then the glassware has to be calibrated by repeated weighing of the volume water contained by the item of glassware. This exercise is also useful for judging how good one's ability to use a pipette is since weighing of the volumes of water dispensed correctly several times from the same pipette should give weights that agree closely.

Primary standards and standard solutions

Primary standards are stable chemical compounds that are available in high purity and which can be used to standardise the standard solutions used in titrations. Titrants such as sodium hydroxide or hydrochloric acid cannot be considered as primary standards since their purity is quite variable. So for instance sodium

hydroxide standard solution may be standardised against potassium hydrogen phthalate, which is available in high purity. The standardised sodium hydroxide solution (secondary standard) may then be used to standardise a standard solution of hydrochloric acid. Table 3.1 lists some commonly used primary standards and their uses.

Table 3.1 Primary standards and their uses

Primary standard	Uses
Potassium hydrogen phthalate	Standardisation of sodium hydroxide solution
Potassium hydrogen phthalate	Standardisation of acetic perchloric acid
Potassium iodate	Standardisation of sodium thiosulphate solution through generation of iodine
Anhydrous sodium carbonate	Standardisation of hydrochloric acid
Zinc metal	Standardisation of EDTA solution

Direct acid/base titrations in the aqueous phase

Strong acid/strong base titrations

Figure 3.1 shows the titration curve obtained from the titration of a strong acid with a strong base. The pH remains low until just before the equivalence point when it rises rapidly to a high value. In many titrations a coloured indicator is used although electrochemical methods of end-point detection are also used. An indicator is a weak acid or base that changes colour between its ionised and un-ionised forms; the useful range for an indicator is 1 pH either side of its pK_a value. For example phenolphthalein (PP) pK_a 9.4 (colour changes between pH 8.4 and pH 10.4) undergoes a structural rearrangement as a proton is removed from one of its phenol groups as the pH rises and this causes the colour change (Fig. 3.2). Methyl orange (MO) pK_a 3.7 (colour changes between pH 2.7 and pH 4.7) undergoes a similar pH dependent structural change. Both these indicators fall within the range of the inflection of the strong acid strong base titration curve.

There are only a few direct strong acid strong base titrations carried out in pharmacopoeial assays.

Strong acid/strong base titrations are used in pharmacopoeial assays of: perchloric acid, hydrochloric acid, sulphuric acid and thiamine hydrochloride.

Weak acid/strong base and weak base/strong acid titrations

On addition of a small volume of the strong acid or strong base to a solution of the weak base or weak acid, the pH rises or falls rapidly to about 1 pH unit below or above the pK_a value of the acid or base. Often a water miscible organic solvent such as ethanol is used to dissolve the analyte prior to addition of the aqueous titrant.

Figure 3.3 shows a plot of pH when 1 M NaOH is added to 25 ml of a 1 M solution of the weak acid aspirin.

In the case of aspirin, the choice of indicator is restricted by where the inflection in its titration curve lies; PP is suitable as an indicator whereas MO is not.

In the example of the titration of quinine with hydrochloric acid (Fig. 3.4), MO is a suitable indicator because it falls within the inflection of the titration curve whereas PP is not suitable.

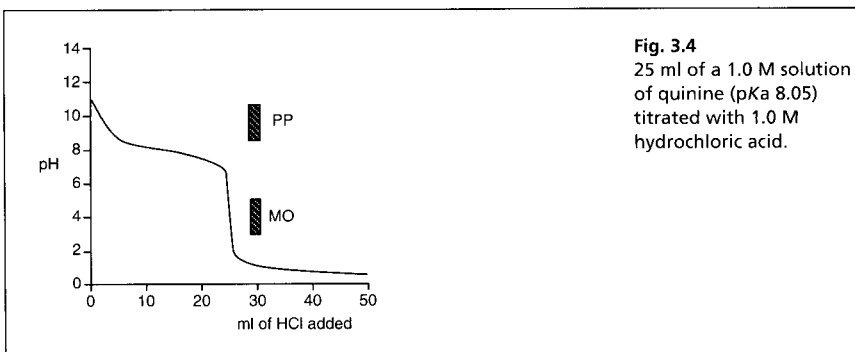
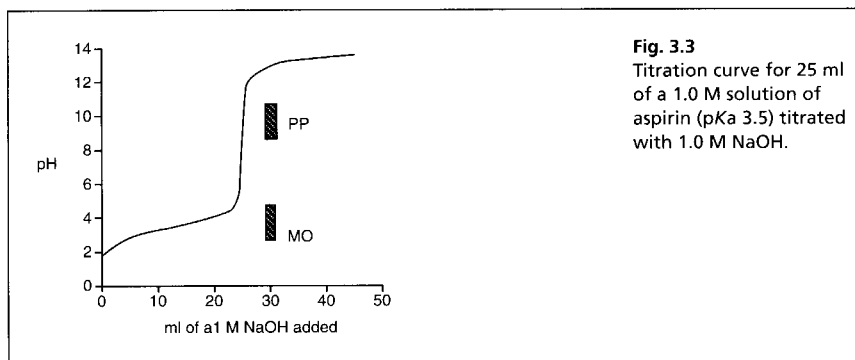
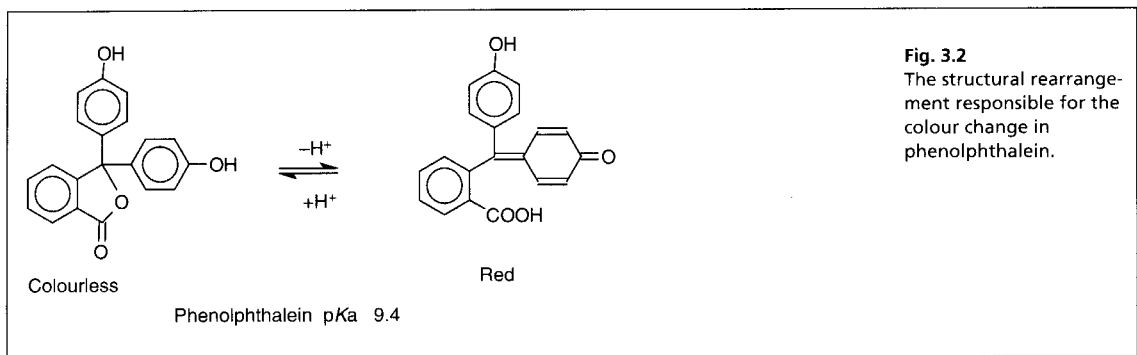
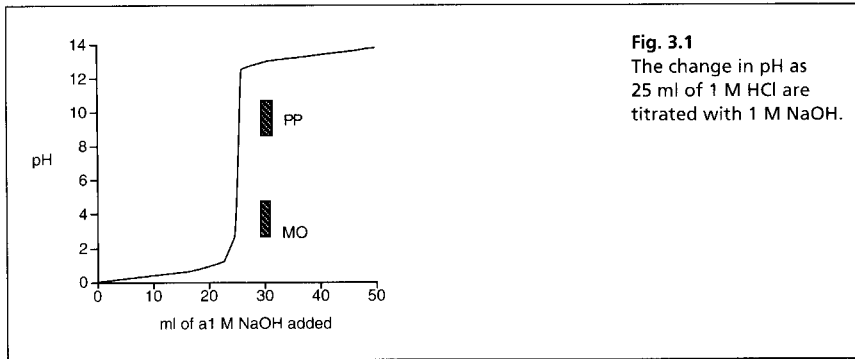

Self-test 3.1

Which of these indicators could be used in the titration of aspirin and which could be used in the titration of quinine?

- (i) Bromophenol blue pKa 4.0.
- (ii) Methyl red pKa 5.1.
- (iii) Cresol red pKa 8.3.
- (iv) Chlorophenol blue pKa 6.0.

Answers: Aspirin: (i) and (iv). Quinine: (i) and (iii)

Some acids or bases can donate or accept more than one proton, i.e. 1 mole of analyte is equivalent to more than 1 mole of titrant. If the pKa values of any acidic or basic groups differ by more than *ca* 4, then the compound will have more than one inflection in its titration curve. Sodium carbonate is a salt of carbonic acid and it can accept two protons. The pKa values of carbonate and bicarbonate are sufficiently different (pKa 10.32 and 6.38) for there to be two inflections in the titration curve. The two stages in the titration are:

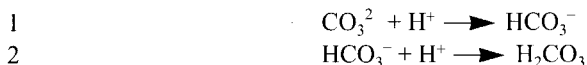

In a titration of sodium carbonate, the first inflection is indicated by PP and the whole titration by MO (Fig. 3.5).

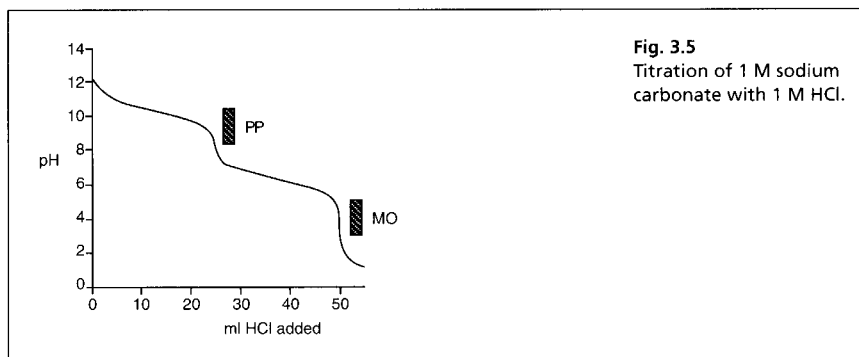

Fig. 3.5
Titration of 1 M sodium carbonate with 1 M HCl.

Self-test 3.2

A sample containing 25.14 g of neutral salts, glucose and a sodium carbonate/bicarbonate buffer was dissolved in 100 ml of water. A 25 ml aliquot of the resultant solution required 20.35 ml of 0.0987 M HCl when titrated to the PP end-point. A second 25 ml aliquot was titrated to the MO end-point and required 56.75 ml of the acid. Calculate the percentage of Na_2CO_3 (MW 106) and NaHCO_3 (MW 84) in the sample.

Answers: 3.39% and 2.12%, respectively

Self-test 3.3

How many inflections do the following substances have in their titration curves when titrated with a strong base? Draw the predominant forms of these substances which would exist at pH 14.



Oxalic acid
pKa 1.19, 4.21

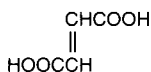

Fumaric acid
pKa 3.03, 4.47

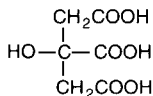

Citric acid
pKa 3.06, 4.74, 5.4

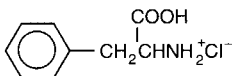

Phenylalanine
pKa 1.83, 9.13

Answers: oxalic acid 1, fumaric acid 1, citric acid 1, phenylalanine 2

Weak acid/strong base titration is used in the pharmacopoeial assays of: benzoic acid, citric acid, chlorambucil injection, mustine injection, nicotinic acid tablets and undecanoic acid.

Indirect titrations in the aqueous phase

These can be of the strong acid/strong base, weak acid/strong base or weak base/strong acid type. The more common examples are weak acid/strong base.

Estimation of esters by back titration

Excess of sodium hydroxide is added to the ester. The following reaction occurs:



The XNaOH is back titrated with HCl using PP as an indicator.

This procedure is used in pharmacopoeial assays of: benzyl benzoate, dimethyl phthalate, ethyl oleate, methyl salicylate, cetostearyl alcohol, emulsifying wax, castor oil, arachis oil, cod liver oil, coconut oil.

Saponification value

The assay of fixed oils provides a special case of ester hydrolysis since they are triesters of glycerol. The saponification value for a fixed oil is the number of mg of KOH equivalent to 1 g of oil. A high value means rancidity, a low value possible adulteration with mineral oil. Almost all edible oils have a saponification value between 188 and 196. Hydrolysis of the fixed oil is carried out with ethanolic KOH.

This procedure is used in the pharmacopoeial assays of: castor oil, cod liver oil, cotton seed oil, almond oil and sesame seed oil.

Acid values are also determined for fixed oils. The acid value for a substance is the number of mg of KOH required to neutralise 1 g of the test substance when it is

Calculation example 3.1

The following data were obtained for a sample of cod liver oil:

Weight of oil taken for analysis = 2.398 g

Ethanol KOH (MW 56.1) used in determination = 0.986 M

Amount of ethanolic KOH used for hydrolysis and in blank titration = 25 ml

Amount of 0.470 M HCl required to neutralise excess KOH = 35.2 ml

Amount of 0.470 M HCl required in the titration of blank = 52.3 ml

Calculation

Amount of KOH used initially = $52.3 \times 0.47 = 24.6$ mmole

Amount of HCl required to neutralise excess KOH = $35.20 \times 0.470 = 16.5$ mmole

Amount of KOH used in hydrolysis = $24.6 - 16.5 = 8.1$ mmole \times MW = mg

Amount of KOH used in the hydrolysis = $8.1 \times 56.1 = 454.0$ mg

Amount of KOH/g of fixed oil used in the hydrolysis = $454/2.398 = 189.3$ mg

Therefore saponification value = 189.3.

Self-test 3.4

Calculate the saponification value of a sample of castor oil from the following data:

- Weight of oil taken for analysis = 2.535 g
- Ethanolic KOH used in the hydrolysis = 1.03 M
- Amount of KOH used in hydrolysis = 25 ml
- Amount of 0.514 M HCl required to neutralise excess KOH = 34.2 ml
- Amount of 0.514 M HCl required in the titration of blank = 50.2 ml

Answer: 182

titrated with 0.1 M ethanolic KOH to a PP end-point. This value is quoted for many fixed oils in order to eliminate rancid oils, which contain large amounts of free fatty acid. Typically acid values for fixed oils are in the range of 1–2.

Estimation of alcohols and hydroxyl values by reaction with acetic anhydride (AA)

Alcohols can be determined by reaction with excess AA (Fig. 3.6). This is a useful titrimetric method because the alcohol group is difficult to estimate by any other means.

Fig. 3.6
Estimation of benzyl alcohol by reaction with acetic anhydride.

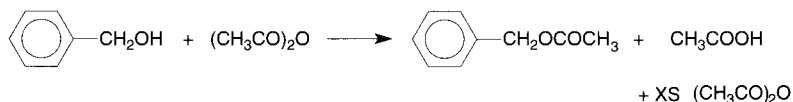

The excess AA and acetic acid may be backtitrated with NaOH using PP as an indicator.

In a related assay, a hydroxyl value is determined for a fixed oil. A 1:3 mixture of AA in pyridine is used in the determination; the pyridine is present as a catalyst. The hydroxyl value may be defined as:

The number of mg of KOH required to neutralise a blank titration of the reagents – the number of mg KOH required to neutralise excess AA + acetic acid after reaction with 1 g of the test substance.

Calculation example 3.2

The following data were obtained for a sample of castor oil:

Weight of castor oil taken for analysis = 1.648 g

Volume of acetic anhydride used for the reaction = 5 ml

Molarity of ethanolic KOH used to neutralise the excess AA + acetic acid = 0.505 M

Volume of ethanolic KOH required to titrate 5 ml of reagent = 53.5 ml

Volume of ethanolic KOH required to neutralise excess AA + acetic acid after reaction with the castor oil = 44.6 ml.

Number of mmoles of KOH used in the blank titration = $53.5 \times 0.505 = 27.0$

Number of mg of KOH used in the titration of the blank = $27.0 \times 56.1 = 1515$

Number of mmoles of KOH used in titration of AA + acetic acid = $44.6 \times 0.505 = 22.5$

Number of mg KOH used in titration of excess AA + acetic acid = $22.5 \times 56.1 = 1262$

Hydroxyl value = $1515 - 1262 / 1.648 = 154$.

To be completely accurate the acid value for the fixed oil should be added to the hydroxyl value since any free acid in the oil will titrate along with the excess reagents giving a small overestimate. The acid value for castor oil is about 2.0 giving a hydroxyl value for the above sample of 156.

Reaction with acetic anhydride is used in pharmacopoeial assays of: benzyl alcohol and dienestrol and determination of hydroxyl values of castor oil, cetosteryl alcohol and cetomacrogol.

Non-aqueous titrations

Theory

Non-aqueous titration is the most common titrimetric procedure used in pharmacopoeial assays and serves a double purpose, as it is suitable for the titration of very weak acids and bases and provides a solvent in which organic compounds are soluble. The most commonly used procedure is the titration of organic bases with perchloric acid in acetic acid. These assays sometimes take some perfecting in terms of being able to judge precisely the end-point.

The theory is very briefly as follows: Water behaves both as a weak acid and a weak base thus in an aqueous environment it can compete effectively with very weak acids and bases with regard to proton donation and acceptance as shown in Figure 3.7.

The effect of this is that the inflection in the titration curves for very weak acids and very weak bases is small because they approach the pH limits in water of 14 and 0 respectively thus making end-point detection more difficult. A general rule is that

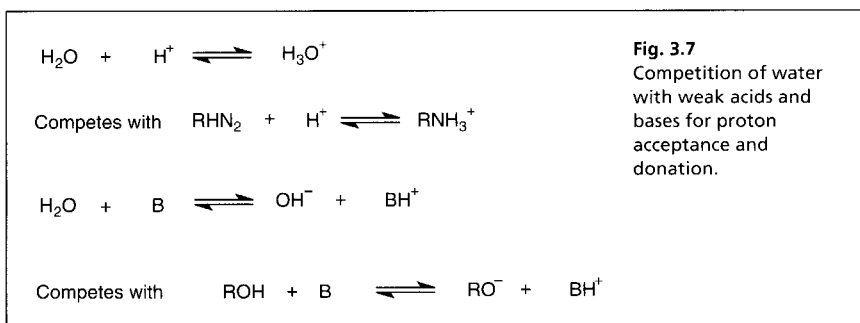

bases with $pK_a < 7$ or acids with $pK_a > 7$ cannot be determined accurately in aqueous solution. Various organic solvents may be used to replace water since they compete less effectively with the analyte for proton donation or acceptance.

Non-aqueous titration of weak bases

Acetic acid is a very weak proton acceptor and thus does not compete effectively with weak bases for protons. Only very strong acids will protonate acetic acid appreciably according to the equation shown below:



Perchloric acid is the strongest of the common acids in acetic acid solution and the titration medium usually used for non-aqueous titration of bases is perchloric acid in acetic acid. Addition of acetic anhydride, which hydrolyses to acetic acid, is used to remove water from aqueous perchloric acid. Weak bases compete very effectively with acetic acid for protons. Oracet blue, quinalidine red and crystal violet (very weak bases) are used as indicators in this type of titration. A typical analysis is shown in Figure 3.8 for LDOPA.

Fig. 3.8
Analysis of DOPA by non-aqueous titration.

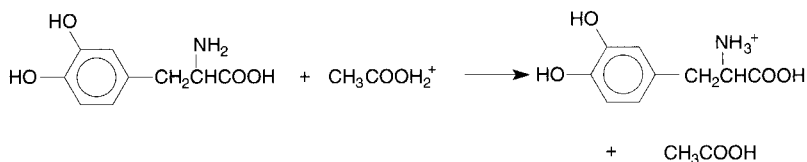

When the base is in the form of a salt of a weak acid, removal of an anionic counter ion prior to titration is not necessary, e.g. for salts of bases with weak acids such as tartrate, acetate or succinate. However, when a base is in the form of a chloride or bromide salt, the counter ion has to be removed prior to titration. This is achieved by addition of mercuric acetate; the liberated acetate is then titrated with acetous perchloric acid. This is illustrated in Figure 3.9 for the example of phenylephrine.HCl.

Non-aqueous titration with acetous perchloric acid is used in the pharmacopoeial assays of: adrenaline, metronidazole, codeine, chlorhexidine acetate, chlorpromazine.HCl, amitriptyline.HCl, propranolol.HCl, lignocaine.HCl and quaternary amine salts such as neostigmine bromide and pancuronium bromide.

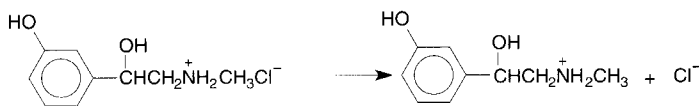

Fig. 3.9
The analysis of phenylephrine hydrochloride by non-aqueous titration.



Non-aqueous titration of weak acids

For the non-aqueous titration of weak acids a solvent such as an alcohol or an aprotic, solvent is used that does not compete strongly with the weak acid for proton donation. Typical titrants are lithium methoxide in methanol or tetrabutyl ammonium hydroxide in dimethylformamide. End-point detection may be carried out with thymol blue as an indicator or potentiometrically (see p. 65).

Non-aqueous titration of acidic groups is carried out in pharmacopoeial assays of: barbiturates, uracils and sulphonamides.

Argentimetric titrations

Argentimetric titrations are based on the reaction:



Potassium chromate may be used as an indicator producing a red colour with excess Ag^+ ion. More widely applicable is the method of back titration. Excess AgNO_3 is added to the sample containing chloride or bromide ions. The excess AgNO_3 is then titrated with ammonium thiocyanate and ammonium ferrous sulphate is used as an indicator of excess SCN^- .



Before the back titration can be carried out, the precipitated AgCl has to be filtered off or coated with diethylphthalate to prevent SCN^- causing dissociation of AgCl . Organically combined chlorine has to be liberated by hydrolysis with sodium hydroxide prior to titration. A halogen attached to an aromatic ring cannot be liberated by hydrolysis and aromatic halides have to be burnt in an oxygen flask in order to release the halogen for titration.

Argentimetric titration is used in pharmacopoeial assays of: sodium chloride and potassium chloride tablets, thiamine hydrochloride, mustine chloride and carbromal.

Compleximetric titrations

These titrations are used in the estimation of metal salts. Ethylenediamine tetracetic acid (EDTA) shown in Figure 3.10 is the usual titrant used. It forms stable 1:1 complexes with all metals except alkali metals such as sodium and potassium. The alkaline earth metals such as calcium and magnesium form complexes which are unstable at low pH values and are titrated in ammonium chloride buffer at pH 10. The general equation for the titration is:



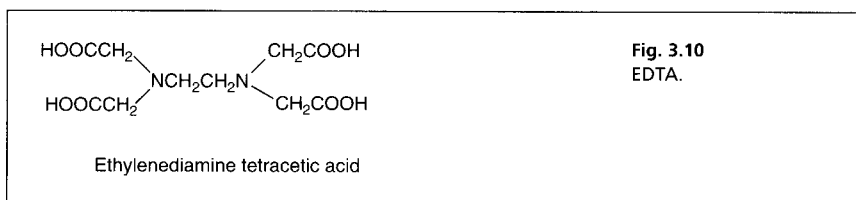

Fig. 3.10
EDTA.

The end-point of the reaction is detected using an indicator dye. The dye is added to the metal solution at the start of the titration, and forms a coloured complex with a small amount of the metal. The first drop of excess EDTA causes this complex to break up resulting in a colour change.

Titration with EDTA is used in the pharmacopoeial assays of: bismuthsubcarbonate, calcium acetate, calcium chloride, calcium gluconate, magnesium carbonate, magnesium hydroxide, magnesium trisilicate, bacitracin zinc, zinc chloride and zinc undecanoate.

Insoluble metal salts are estimated by back titration; the sample is heated with excess EDTA to form the soluble EDTA complex of the metal and then the excess EDTA is titrated with salt solutions containing Mg^{2+} or Zn^{2+} of known concentration.

Back titration with EDTA is used in the pharmacopoeial assays of: aluminium glycinate, aluminium hydroxide, aluminium sulphate, calcium hydrogen phosphate.

Redox titrations

Redox titrations are based on the transfer of electrons between the titrant and the analyte. These types of titrations are usually followed by potentiometry, although dyes which change colour when oxidised by excess titrant may be used.

Theory

Reduction potential is a measure of how thermodynamically favourable it is for a compound to gain electrons. A high *positive* value for a reduction potential indicates that a compound is readily reduced and consequently is a strong oxidising agent, i.e. it removes electrons from substances with lower reduction potentials. The oxidised and reduced form of a substance are known as a redox pair. Table 3.2 lists the standard reduction potentials for some typical redox pairs.

Table 3.2 Standard reduction potential (E_0) for some redox pairs relative to the standard hydrogen electrode potential 0

		E_0
$Ce^{4+} + e$	→	Ce^{3+} 1.61 V
$MnO_4^- + 5e + 8H^+$	→	$Mn^{2+} + 4H_2O$ 1.51 V
$Cl_2 + 2e$	→	$2Cl^-$ 1.36 V
$Br_2 + 2e$	→	$2Br^-$ 1.065 V
$Fe^{3+} + e$	→	Fe^{2+} 0.771 V
$I_2 + 2e$	→	$2I^-$ 0.536 V
$AgCl + e$	→	$Ag + Cl^-$ 0.223 V
$2H^+ + 2e$	→	H_2 0 V
$Fe^{2+} + 2e$	→	Fe -0.440 V
$Ca^{2+} + 2e$	→	Ca -2.888 V

A substance with a higher reduction potential will oxidise one with a lower reduction potential. The difference in potential between two substances is the reaction potential and is approximately the potential difference which would be

measured if the substances comprised two halves of an electrical cell. For example Cl_2 will oxidise Br^- according to the following equation:



Taking values from Table 3.2 the reaction potential is given by:

$$1.36 - 1.065 = 0.29 \text{ V}$$

For the reaction:

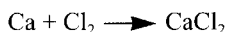

The reaction potential is given by: $1.36 - (-2.888) = 4.248 \text{ V}$ (i.e. a large difference and calcium burns in chlorine).

Self-test 3.5

Complete the equations where reaction is possible and indicate the reaction potential.

- (i) $\text{I}_2 + 2 \text{Cl}^- \longrightarrow$
- (ii) $\text{Br}_2 + 2 \text{I}^- \longrightarrow$
- (iii) $\text{Ce}^{4+} + \text{Fe}^{2+} \longrightarrow$
- (iv) $\text{I}_2 + \text{Fe} \longrightarrow$
- (v) $\text{Fe}^{3+} + \text{AgCl} \longrightarrow$

Answers: (i) No reaction; (ii) 0.529 V; (iii) 0.839 V; (iv) 0.976 V; (v) No reaction (Ag is already in its Ag⁺ form)

In the above examples we have ignored the effect of concentration of oxidant and reductant on E_0 values; in fact E (the observed electrode potential) is stable over a wide range of concentrations. The E -value for a solution containing a redox pair is governed by the Nernst equation:

$$E = E_0 + 2RT/nF \ln [\text{Ox}]/[\text{Red}]$$

where [Ox] is the concentration of the oxidised form of a particular substance and [Red] is the concentration of the reduced form of a particular substance.

F = Faraday's constant

n = number of electrons transferred in the reaction

By substituting a value for the constant terms this equation can also be written as:

$$E = E_0 + 0.0591/n \log [\text{Ox}]/[\text{Red}]$$

Where n is the number of electrons transferred during the reaction. It is clear that E is approximately equal to E_0 except when there is a large difference between [Ox] and [Red].

Self-test 3.6

Calculate the E for the following redox pair when $\text{Mn}^{3+} = 0.5 \text{ M}$ and $\text{Mn}^{2+} = 0.01 \text{ M}$ ($E_0 \text{ Mn}^{3+}/\text{Mn}^{2+} = 1.51 \text{ V}$).

Answer: 1.61 V

The titration curve for Fe^{2+} against Ce^{4+} is shown in Figure 3.11. This curve shown is for a titration carried out with a standard hydrogen electrode as the reference electrode.

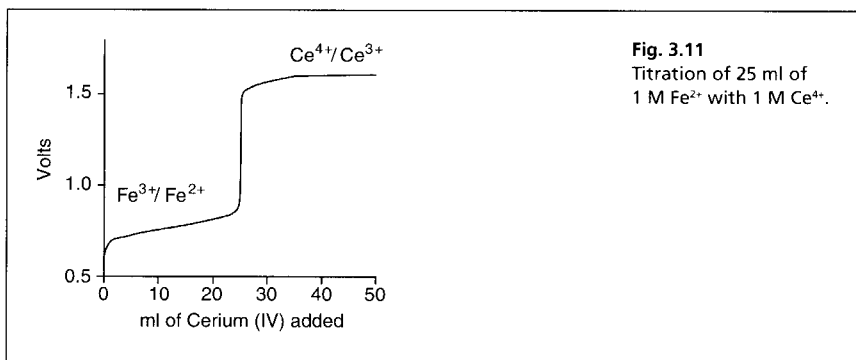

Fig. 3.11
Titration of 25 ml of
1 M Fe^{2+} with 1 M Ce^{4+} .

Where a reference electrode has a reduction potential > 0 , then the predicted reading of the potential for a redox pair is obtained by subtracting the reduction potential for the reference electrode, e.g. for an Ag/AgCl reference electrode 0.223 V is subtracted.

Self-test 3.7

Using the values in Table 3.1, what would be the approximate potential measured for the $\text{Fe}^{3+}/\text{Fe}^{2+}$ redox pair present in the first part of the titration shown in Figure 3.11 measured against:

- (i) A standard hydrogen electrode.
- (ii) An Ag/AgCl electrode?

Similarly what would the approximate potential be for the $\text{Ce}^{4+}/\text{Ce}^{3+}$ redox pair on the plateau after the end-point measured against?

- (iii) A standard hydrogen electrode.
- (iv) An Ag/AgCl electrode.

Answers: (i) 0.77 V; (ii) 1.61 V; (iii) 0.55 V; (iv) 1.39 V

In carrying out redox titrations, standard Ag/AgCl or $\text{Hg}/\text{Hg}_2\text{Cl}_2$ electrodes are used as a reference in conjunction with an inert redox electrode, e.g. platinum, which takes its potential from the particular redox pair in the solution in which it is immersed.

Redox titration is used in pharmacopoeial assays of: ferrous salts, hydrogen peroxide, sodium perborate and benzoyl peroxide by titration with KMnO_4 . In the case of KMnO_4 titrations the end-point may be detected when the purple colour of the permanganate persists.

Iodometric titrations

There are a number of types of iodometric assay.

Direct titrations

Iodine is a moderately strong oxidising agent (See Table 3.1). During oxidation iodine is reduced as follows:

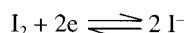

It will oxidise substances with lower reduction potentials, e.g. the titration of ascorbic acid is carried out as shown in Figure 3.12.

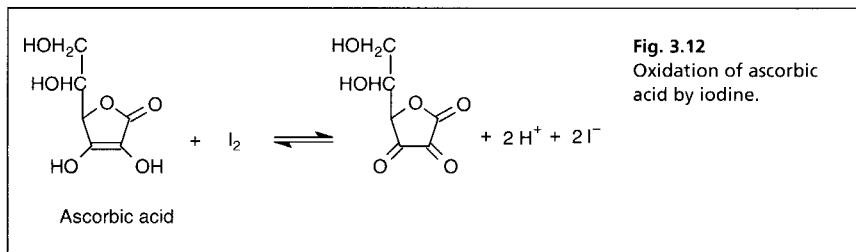

The iodine solution used is standardised against sodium thiosulphate (see later). In addition the end-point is detected using starch indicator, which produces a blue colouration with excess iodine.

Direct iodometric titration is used in pharmacopoeial assays of: ascorbic acid, sodium stilbilgucanate, dimercaprol injection and acetarsol.

Iodine displacement titrations

These titrations involve displacement of iodine from iodide by a stronger oxidising agent followed by titration of the displaced iodine with sodium thiosulphate.

For example, the available chlorine in bleach is estimated as follows:

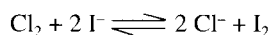

The displaced iodine is then titrated with thiosulphate according to the following equation:

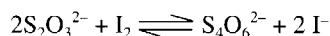

A different approach is used in the estimation of phenols. Bromine is generated by reaction of potassium bromide with a defined volume of a standard solution of potassium bromate according to the following equation:

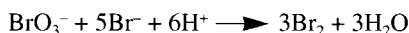

The bromine generated is then reacted with the phenol and 1 mole of phenol reacts with 3 moles of bromine (Fig. 3.13).

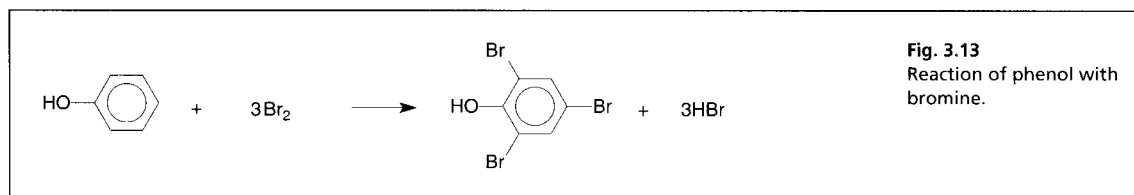

Excess bromine is used and the bromine remaining after the above reaction is reacted with iodide as follows:



The liberated iodine is then titrated with thiosulphate thus quantifying the excess bromine.

Iodine displacement titrations are used in pharmacopoeial assays of: liquefied phenol, methyl hydroxybenzoate, propyl hydroxybenzoate and phenidione.

chloroform, which becomes coloured by the ion pair. Titration of the lipophilic anion or cation is carried out with a lipophilic counter ion, e.g. benzethonium chloride or sodium dodecyl sulphate. At the end-point excess of the titrant breaks up the coloured complex in the chloroform layer.

Ion pair titration using a coloured indicator complex is used in pharmacopoeial assays of: dicyclamine elixir, procyclidine tablets, sodium dodecyl sulphate and cetrimide emulsifying ointment.

Titration using iodide as a lipophilic anion

This procedure is more widely used in pharmacopoeial assays than the dye extraction procedure. Excess potassium iodide is added to an aqueous solution of the analyte, which is a lipophilic cation. A lipophilic ion pair is formed between the cation and the iodide ion and is then removed by extraction into an organic phase such as chloroform. The excess iodide remaining in the aqueous phase is then titrated in concentrated HCl (> 4 M) with potassium iodate. The iodate oxidises iodide to I^+ , which immediately reacts with Cl^- to give ICl resulting in the following equation:

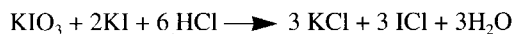

A small amount of chloroform is used as an indicator and in the presence of the reaction mixture it becomes coloured purple by traces of iodine, which are present during titration. The purple colour disappears at the end-point when the conversion of all I^- and I_2 into ICl is complete.

Ion pair formation with iodide followed by titration of excess iodide with iodate is utilised in pharmacopoeial assays of: cetrime, cetylpyridium bromide, domiphen bromide and benzalkonium chloride.

Diazotisation titrations

This type of titration is quite simple to carry out and is very useful for the analysis of sulphonamide antibiotics and aminobenzoic acid-derived local anaesthetics. Titration is carried out with acidified sodium nitrite causing the primary aromatic amine function to be converted to a diazonium salt shown in Figure 3.15 for sulphacetamide.

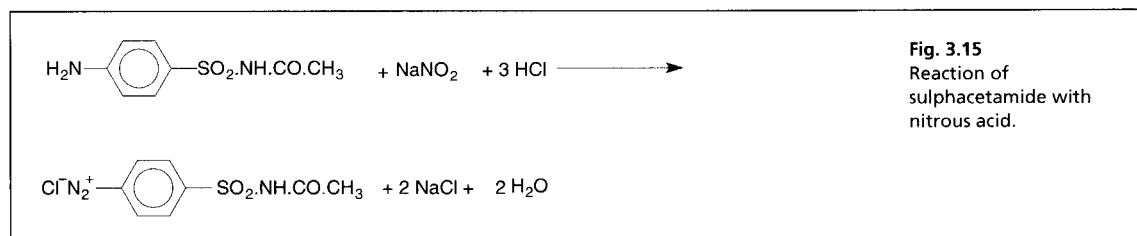

A small amount of iodide is included in the titration mixture. At the end-point the first drop of excess of nitrous acid converts iodide to iodine and this is detected using starch indicator.

Titration with nitrous acid is used in pharmacopoeial assays of the following: benzocaine, dapson, primaquine, procainamide, procaine, sulphacetamide, sulphadoxine, sulphamethizole, sulphapyridine and sulphathiazole.

Potentiometric titrations

Potentiometric end-point detection

All of the titrations discussed in the preceding sections can be carried out using a suitable electrode to measure the potential of the solution as the titration progresses. The advantage of making potentiometric measurements in order to detect end-points is that the measurements can be made in solutions which are coloured, unlike indicator-based end-point detection, and give unambiguous end-points where indicator colour changes are not clear or sudden. The disadvantage of potentiometric titrations is that they are relatively slow since time has to be allowed for readings to stabilise, particularly near the end-point of the titration. However, potentiometric titrations can be automated and potentiometric end-point detection is used in automatic titrators where the titrant is pumped into the sample under microprocessor control. The electrode which is usually used to make the measurements in potentiometric titrations is the pH-sensitive glass indicator electrode. This electrode consists of a pH-sensitive glass membrane bulb which encloses a phosphate buffer solution containing potassium chloride solution and saturated with silver chloride. The solution is in contact with an internal reference electrode which consists of a silver wire. The circuit is completed by a second reference electrode, which in modern combination electrodes is a second silver/silver chloride electrode, which contacts the external solution via a porous junction (Fig. 3.16). The electrode monitors the variation in the potential difference which is largely caused by the interaction of hydrogen ions with the outer surface of the pH sensitive glass membrane.

Fig. 3.16
pH-sensitive glass
electrode.

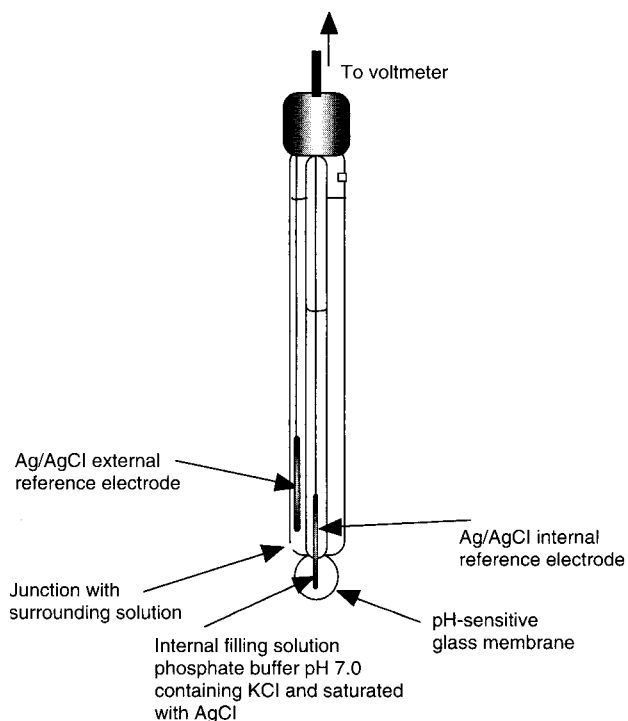

The potential which develops on the inner and outer glass surfaces of the electrode is due to the following equilibria:

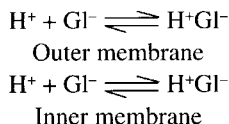

The number of G^- sites on the outer membrane increases with decreasing $[\text{H}^+]$ and thus its potential becomes increasingly negative with respect to inner surface with increasing pH. The Nernst equation can be simplified and written in the following form for the glass electrode when the temperature is 20°C :

$$E = E_k - 0.0591 \text{pH.}$$

where E is the measured potential in volts and E_k is a constant composed of the sum of the various potential differences within the electrode, which do not vary appreciably. The combination electrode is constructed so that its potential is *ca* 0 V at pH 7.0. It can be seen from the equation above that E changes by 59.1 mV for each pH unit.

Self-test 3.9

Assuming an indicator electrode is constructed so that $E = 0$ V at pH 7.0 calculate what its potential would be at: (i) pH 1; (ii) pH 14.

Answers: (i) -0.41 V; (ii) $+0.36$ V.

When potentiometric titration is carried out, the volume of titrant added is plotted against the measured potential. Since the electrode takes time to equilibrate, the volume of titrant required to reach the end-point is first calculated and a volume of titrant is added to within *ca* 1 ml of the end-point. Then the titrant is added in 0.1 ml amounts until the steep inflection in the titration curve is passed. The end-point of the titration is the point where the slope of the titration curve is at its maximum. Thus if dE/dV is plotted for the titration, the maximum of the plot gives the end-point. The end-point can also be determined from the mid-point of the inflection in the titration curve or from the tabulated data. Figure 3.17 shows a curve for the titration of 2 mmoles of aspirin with 0.1 M NaOH. The end-point corresponds to the mid-point of the inflection or if the tabulated data is examined it can be taken to be the mid-point between the two volumes where dE/dV is greatest, i.e. at 20.05 ml between 20 and 20.1 ml. The actual end-point for exactly 2 mmoles of aspirin titrated with 0.1 M NaOH should be 20 ml, addition of 0.1 ml aliquots towards the end-point means that the end-point is only accurate to within ± 0.05 ml.

Use of potentiometric titration to determine pKa values

Potentiometric titration provides the principal method for determining pK_a values and it is best applied to substances with pK_a values < 11 . For example the pK_a of benzoic acid can be determined as follows: A 0.01 M solution of benzoic acid (50 ml) is titrated with 0.1 M KOH. The KOH is added in 0.5 ml increments; it would be expected that 5 ml of 0.1 M KOH would be required to neutralise the

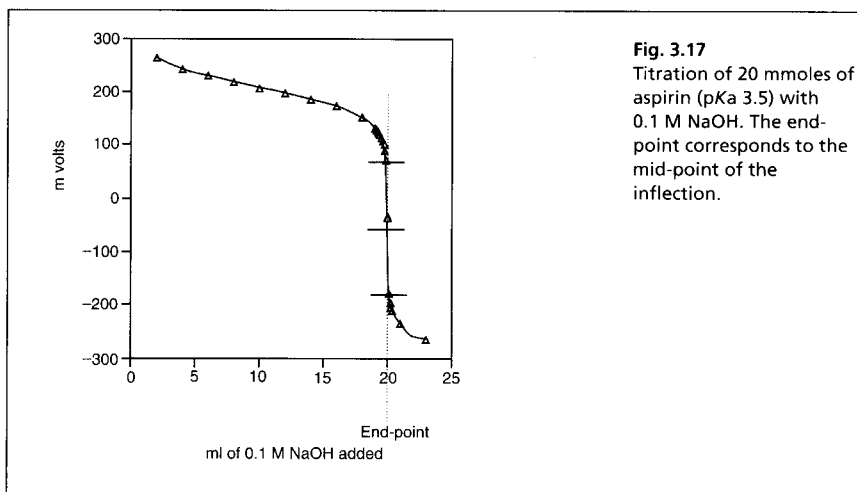

Table 3.3 Potential difference values obtained for titration of 2 mmoles of aspirin (pKa 3.5) against 0.1 M NaOH

ml of 0.1 M NaOH added	potential mV
14	185
16	172
18	151
19	132
19.1	129
19.2	126
19.3	122
19.4	119
19.5	113
19.6	107
19.7	100
19.8	89
19.9	71
20	-44
20.1	-177
20.2	-195
20.3	-206
20.4	-212
21	-236
23	-266

benzoic acid. The pH of the titration is monitored with a glass electrode and the pH of the mixture after 2.5 ml of 0.1 M KOH has been added will equal the pKa value of benzoic acid since:

$$\text{pKa} = \text{pH} - \log \frac{[\text{C}_6\text{H}_5\text{COOK}]}{[\text{C}_6\text{H}_5\text{COOH}]}$$

The pKa value may be checked after addition of each 0.5 ml since the concentrations of acid and salt are known at each point on the titration curve. The slight increase in volume due to addition of the 0.1 M KOH may be ignored. For a base, the Henderson-Hasselbalch equation is written as given in Chapter 2, page 20.

Self-test 3.10

50 ml of a 0.01 M solution of the base diphenhydramine is titrated with 0.1 M HCl and the pH is monitored with a glass electrode. After 3 ml of 0.1 M HCl have been added the pH of the solution is 8.82. What is the pKa of diphenhydramine?

Answer: 9.0

Karl Fischer titration (coulometric end-point detection)

The Karl Fischer titration is a specialised type of coulometric titration. Coulometry itself is a useful technique, but is not used as a mainstream technique for pharmaceutical analysis. Essentially coulometry is based on the electrolytic reduction of the analyte, i.e. the analyte is reduced by electrons supplied by a source of electrical power and the amount of charge passed in order to convert the analyte to its reduced form is equivalent to the amount of analyte present in solution.

According to Faraday's Law, where one molecule of analyte reacts with one electron, 1 mole of analyte will react with 96 485 coulombs of electricity where coulombs = amps \times s. If iodine is reduced by coulometry, the following reaction occurs:

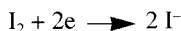

One mole of iodine will consume $2 \times 96\,485$ coulombs of electricity. The Karl Fischer titration is widely used for the determination of water in pharmaceuticals. Quantitation in this case is not based on the total amount of current which flows through the solution but the reduction of iodine is simply used to indicate the end-point of the titration. The reagent consists of mixture of anhydrous methanol, anhydrous pyridine, iodine and sulphur dioxide. The equation for the reaction of water with the reagent looks complicated (see below)

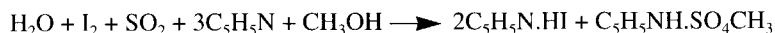

but the essential thing to note is that the presence of water causes the conversion of iodine to iodide through its reduction by sulphur dioxide. When a titration is carried out the reagent is added to the sample and reacts with the water in it. A potential is applied across the solution containing the sample and no current flows until at the end-point, when all the water has been consumed. The presence of iodine in solution from addition of excess reagent allows current to flow through the solution in order to carry out the reduction of iodine shown in the equation above, thus providing the end-point detection.

The Karl Fischer titration is used to quantify water in pharmacopoeial assays of: ampicillin trihydrate, benzylpenicillin sodium, gentamycin sulphate, tetracosactrin and tobramycin.

Automation of wet chemical methods

Automatic titration (Fig. 3.18)

Titration can be automated and controlled by a microprocessor. The titrant is delivered via an automatic burette and the end-point is detected potentiometrically

with a glass combination electrode. Alternatively, if ions other than hydrogen are being measured another ion-selective electrode may be used. The apparatus is microprocessor controlled and can be programmed to run in various modes:

- (i) The rate of delivery of the titrant can be controlled according to rate of change of potential so it is added more slowly as the rate of change in potential increases, i.e. as the end-point is approached.
- (ii) For titrations which take time to equilibrate as the titrant is added, the instrument can be programmed to delay after each incremental addition until the potential becomes stable.
- (iii) The detection of the end-point can be pre-set at a fixed potential.

Fig. 3.18
Automatic titration
apparatus.

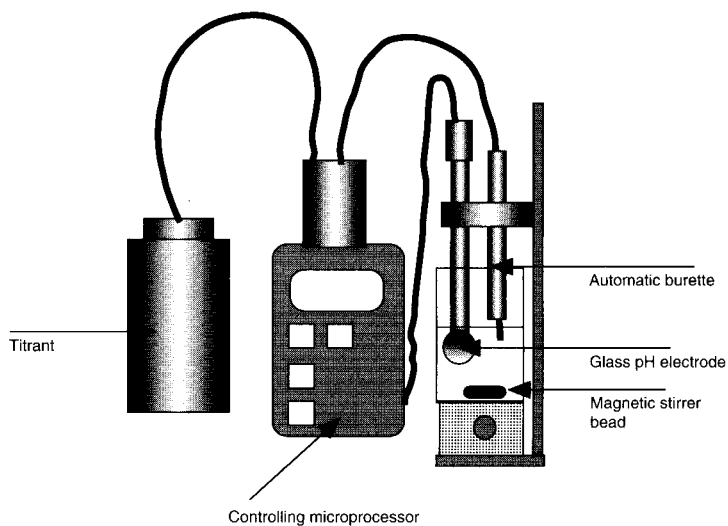

The microprocessor control also enables the instrument to be set to calculate pK_a values directly from the pH profile it obtains by titration of a sample. A sample changer can be incorporated so that several samples can be automatically titrated.

Flow injection analysis

Flow injection analysis (FIA) represents a refinement of wet chemical methods. The basis of the technique is that the sample is injected into a continuously flowing stream of reagent. The sample reacts with the reagent and this reaction is measured with a detector. The range of detectors available is the same as that which is used in conjunction with HPLC (Ch. 12, p. 248) except that there is no chromatographic separation involved. Thus the technique is not as selective as chromatographic methods and its selectivity is dependent on the specificity of the reaction between the analyte and the reagent or the property used for detecting it. A simple schematic diagram of a flow injection analysis system is shown in Figure 3.19. The basic set up may be modified to include several manifolds that allow the introduction of the sample followed by additional reagents. The advantages of the technique are its cheapness and rapidity.

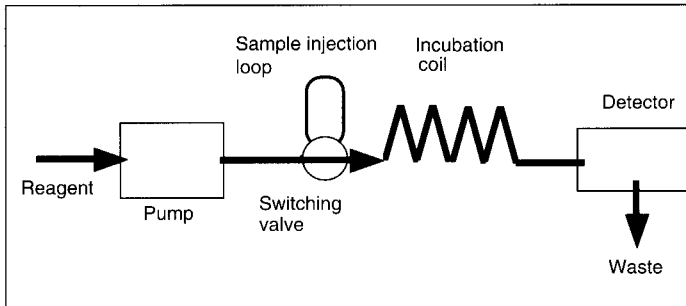

Fig. 3.19
A simple flow injection analysis system.

A precise volume of sample (1–100 μl) is injected and passed through the incubation coil, which is of sufficient length to allow the sample to disperse in the reagent but not long enough for the sample to become diluted so much that the integrity of the plug of sample is lost. The detector response is dependent on the degree of dispersion of the sample. A typical flow of the reagent + analyte is as shown in Figure 3.20.

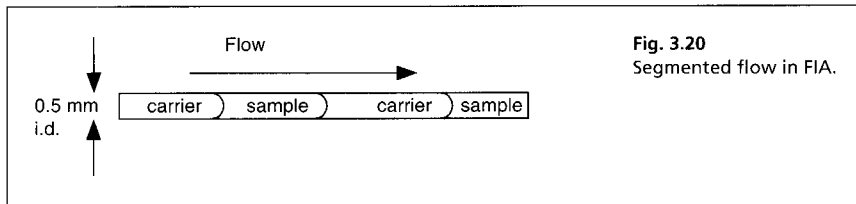

Fig. 3.20
Segmented flow in FIA.

The parameters which have to be optimised include:

- (i) The length and internal diameter of the incubation coil
- (ii) The flow rate
- (iii) The volume of sample injected
- (iv) The concentration of sample and reagents used.

Since a number of factors are involved in the optimisation, some time is required to develop the method. However, when set up, the method can replace titrations and replicate analyses can be conducted very quickly with minimal consumption of reagents.

As in chromatography, the ideal peak shape obtained in FIA should be Gaussian, although in practice the ideal shape may not have time to develop. The mathematics governing the dispersion processes have been developed thoroughly and the process is largely analogous to the dispersion occurring in capillary gas chromatography, where longitudinal diffusion is the major factor governing band broadening.

Figure 3.21 illustrates an application of FIA to the Karl Fischer titration. The consumption of the reagent by water is detected spectrophotometrically by monitoring the stream of reagent at 615 nm. The absorbance due to the iodine in the reagent is removed by its reaction with water, which causes formation of iodide and thus negative absorbance is measured.

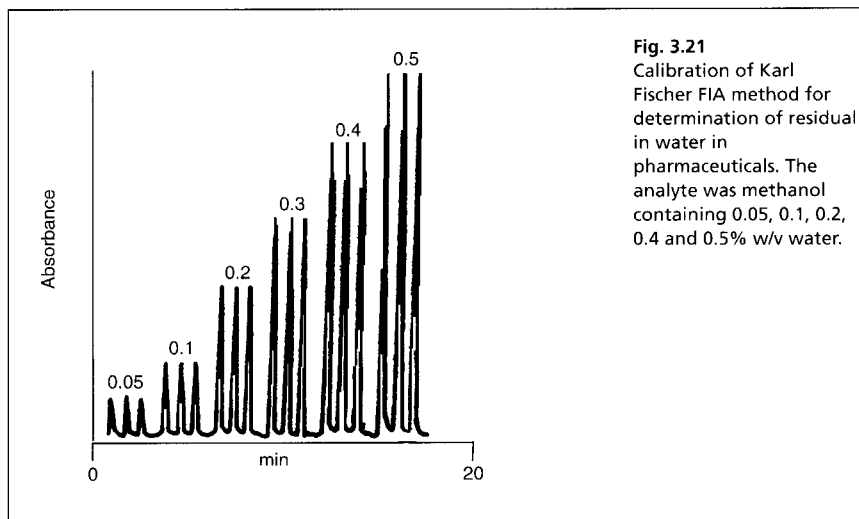

Applications of FIA in pharmaceutical analysis

Determination of chloroxine

The antibiotic chloroxine was determined utilising the formation of a complex between the drug and Al^{3+} in an FIA system. The complex was determined by measurement of fluorescence with 399 nm as the excitation wavelength and 496 nm as the emission wavelength. In order to ensure solubility of the complex in the aqueous reagents a surfactant was included in the reagent mixture. The precision of the method was greater than that obtained using a laborious batch method for measuring samples manually using a fluorescence spectrophotometer.³

Determination of captopril

A FIA method for the determination of captopril was based on the oxidation of the thiol group in the molecule by Ce^{4+} . This reaction results in the emission of light (chemiluminescence), which can be measured. In this example the dye rhodamine G was used to enhance the emission of light by the reaction. The method developed was rapid and precise.⁴

Determination of non-steroidal anti-inflammatory drugs

Diclofenac sodium, famotidine and ketorolac were analysed utilising their formation of a coloured charge transfer complex with 2,4 dichloro-6-nitrophenol. The complexes were detected by UV/visible spectrophotometry at 450 nm. The method was not affected by the presence of common excipients in the formulations analysed. The precision and accuracy of the method was comparable to that of HPLC methods used to analyse the same samples.⁵

Determination of promethazine

The generation of a coloured product upon the oxidation of promethazine with Ce^{4+} was used in the development of a FIA method. Promethazine in tablet form could be analysed by this method with a precision of $\pm 1\%$ and at a rate of 122 samples per h.⁶ In a similar method promazine was oxidised by passing through a short column containing MnO_2 and then the oxidation product was measured.⁷

Determination of chlorocresol

Chlorocresol is a preservative commonly used in injections and its determination often involves the use of laborious extraction procedures in order to separate it from formulation components, followed by spectrophotometric measurement. A FIA method for chlorocresol was developed by utilising its reaction with nitrous acid to form a coloured nitro compound. The method was accurate to 99.5% of the true value of chlorocresol in a formulation and a precision of $\pm 1\%$ was achieved.⁸

Limit test for heavy metals

Many pharmacopoeial monographs contain a limit test for heavy metals. Sometimes the metal is specified, e.g. lead, but often the test is more general. Pharmacopoeial tests often involve precipitation of the metals as their sulphides. A FIA method was developed based upon complex formation between heavy metals and diethyldithiocarbamate (DDC). Figure 3.22 shows the FIA system used for this analysis and illustrates how relatively simple components can be assembled to carry out a complex analytical task. The analysis was achieved by using a segmented flow system where alternate segments of buffer solution + reagent and carbon tetrachloride were produced. In the first extraction coil, the heavy metals in the sample are extracted as their complexes, along with some excess complexing agent, into carbon tetrachloride. In the second extraction coil, the excess reagent in the organic layer is back extracted by the borax solution, which is mixed into the carrier stream. The flow was then passed into a phase separator which only allowed the organic solvent to flow through to the detector.⁹

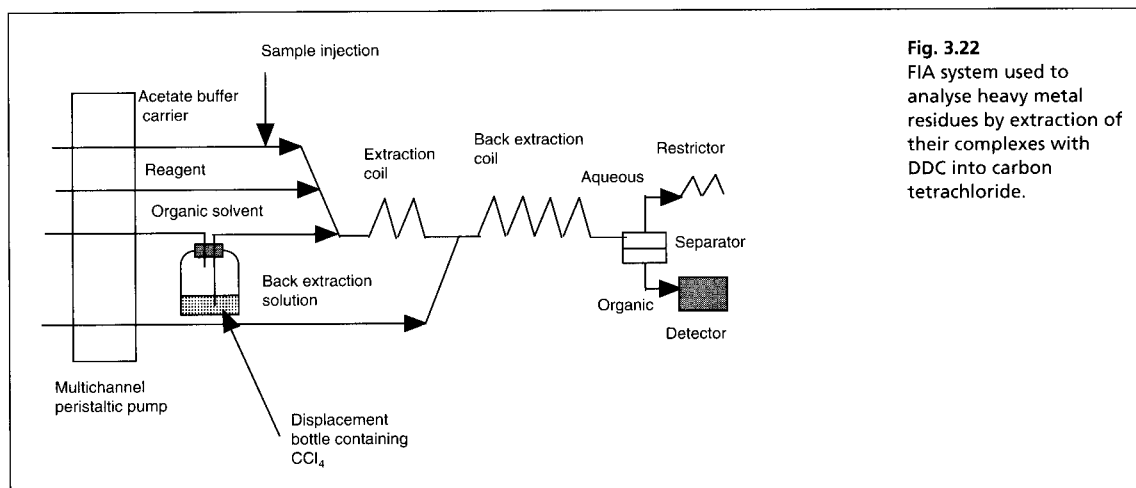

Fig. 3.22
FIA system used to analyse heavy metal residues by extraction of their complexes with DDC into carbon tetrachloride.

Use of segmented flow in determination of partition coefficients

A system similar to the one described above was used for determination of partition coefficients. A FIA system with segmented flow was devised so that the partitioning of a drug between aqueous buffer and chloroform could be measured. The aqueous and organic phases were separated using a phase separator. The system could be set up to measure the concentration of the drug in either the organic or the aqueous phase. Such a system enables rapid repeat determinations of partition coefficient at various pH values with minimal sample consumption.¹⁰

Automated dissolution testing

FIA was used to optimise sampling from a tablet dissolution apparatus in order to determine the rate of release of iron (II) from a sustained release formulation. The dissolution medium was automatically sampled at 30-minute intervals and the 100 μ l aliquots of medium were mixed with the iron complexing agent ferrozine, diluted and then passed into a spectrophotometric detector. The system was microprocessor controlled thus enabling unattended sampling of the dissolution medium for a prolonged period.¹¹

References

1. A.H. Beckett and J.B. Stenlake. *Practical Pharmaceutical Chemistry Part One*, 4th Edn. Athlone Press (1988).
2. D.A. Skoog and D.M. West. *Fundamentals of Analytical Chemistry*, 4th Edn. Sanders College Publishing (1986).
3. T. Pérez-Ruiz, C. Martínez-Lozano, V. Tomás and J. Carpena. *J. Pharm. Biomed. Anal.* 14, 1505–1511 (1996).
4. Z.D. Zhang, W.R.G. Baeyens, X.R. Zhang and G Vander Weken. *J. Pharm. Biomed. Anal.* 14, 939–945 (1996).
5. B.V. Kamath, K. Shivram and A.C. Shah. *J. Pharm. Biomed. Anal.* 12, 343–346 (1994).
6. J.M. Calatayud and T.G. Sancho. *J. Pharm. Biomed. Anal.* 10, 37–42 (1992).
7. A. Kojlo, H. Puzanowska-Tarasiewicz and J.M. Calatayud. *J. Pharm. Biomed. Anal.* 10, 785–788 (1992).
8. M.N. Bloomfield and K.A. Prebble. *J. Pharm. Biomed. Anal.* 10, 775–778 (1992).
9. L-G Danielsson and Z. Huazhang. *J. Pharm. Biomed. Anal.* 8, 937–945 (1989).
10. L-G Danielsson, L. Nord and Z. Yu-Hui. *J. Pharm. Biomed. Anal.* 10, 405–412 (1992).
11. C.A. Georgiou, G.N. Valsami, P.E. Macheras and M.A. Koupparis. *J. Pharm. Biomed. Anal.* 12, 635–641 (1994).

4

Ultraviolet and visible spectroscopy

Keypoints

Introduction

Factors governing absorption of radiation in the UV/visible region

Beer-Lambert Law

Instrumentation

Instrument calibration

Calibration of absorbance scale

Calibration of wavelength scale

Determination of instrumental resolution

Determination of stray light

UV spectra of some representative drug molecules

Steroid enones

Ephedrine: the benzoid chromophore

Ketoprofen: extended benzene chromophore

Procaine: amino group auxochrome

Phenylephrine: hydroxy group auxochrome

Use of UV/visible spectrophotometry to determine pKa values

Applications of UV/visible spectrophotometry to

pharmaceutical quantitative analysis

Introduction
Assay examples

Difference spectrophotometry

Analysis of aspirin in dextropropoxyphene compound tablets

Derivative spectra

Applications of UV/visible spectroscopy in preformulation and formulation

Partition coefficient

Solubility

Release of a drug from a formulation

KEYPOINTS

Principles

Radiation in the wavelength range 200-700 nm is passed through a solution of a compound. The electrons in the bonds within the molecule become excited so that they occupy a higher quantum state and in the process absorb some of the energy passing through the solution. The more loosely held the electrons are within the bonds of the molecule the longer the wavelength (lower the energy) of the radiation absorbed.

Applications in pharmaceutical analysis

- A robust, workhorse method for the quantification of drugs in formulations where there is no interference from excipients.
- Determination of the pKa values of some drugs.
- Determination of partition coefficients and solubilities of drugs.
- Used to determine the release of drugs from formulations with time, e.g. in dissolution testing.
- Can be used to monitor the reaction kinetics of drug degradation.
- The UV spectrum of a drug is often used as one of a number of pharmacopoeial identity checks.

Strengths

- An easy-to-use, cheap and robust method offering good precision for making quantitative measurements of drugs in formulations
- Routine method for determining some of the physico-chemical properties of drugs which need to be known for the purposes of formulation
- Some of the problems of the basic method can be solved by the use of derivative spectra.

Limitations

- Only moderately selective. The selectivity of the method depends on the chromophore of the individual drugs, e.g. a coloured drug with an extended chromophore is more distinctive than a drug with a simple benzene ring chromophore
- Not readily applicable to the analysis of mixtures.

Introduction

The interaction between radiation and matter is a fascinating area in its own right. Most drug molecules absorb radiation in the ultraviolet region of the spectrum although some are coloured and thus absorb radiation in the visible region, e.g. a substance with a blue colour absorbs radiation in the red region of the spectrum. The absorption of UV/visible radiation occurs through the excitation of electrons within the molecular structure to a higher energy state; Figure 4.1 illustrates the nature of the transitions taking place. These transitions occur from the bottom vibrational state in the electronic ground state of the molecule to any one of a number of vibrational levels in the electronic excited state. The transition from a single ground state energy to one of a number of excited states gives width to UV spectra. Figure 4.1 shows a UV spectrum in which individual bands for different V_0 to V_n transitions can be seen. Vibrational fine structure can be seen although the bands overlap extensively; the vibrational bands themselves have width due to rotational transitions which are intermediate in energy between each vibrational transition. The relative energy of electronic:vibrational:rotational transitions is 100:1:0.01. In most molecules the vibrational behaviour is complex and the degree of overlap of the different energies of the vibrational transitions is too great for vibrational fine structure to be observed.

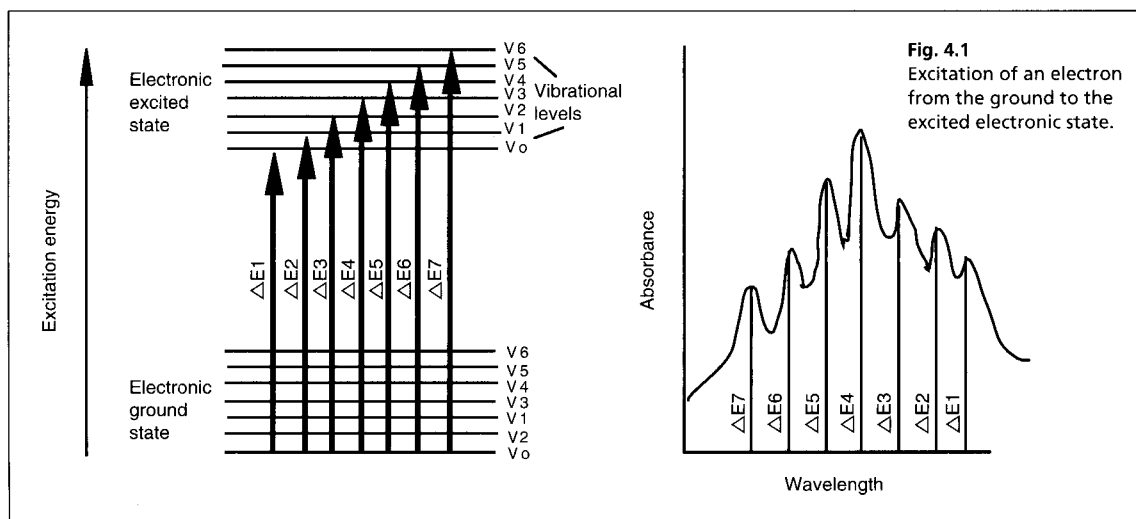

Factors governing absorption of radiation in the UV/visible region

Radiation in the UV/visible region is absorbed through excitation of the electrons involved in the bonds between the atoms making up the molecule so that the electron cloud holding the atoms together redistributes itself and the orbitals occupied by the bonding electrons no longer overlap. Short wavelength UV radiation < 150 nm (> 8.3 eV) can cause the strongest bonds in organic molecules to break and thus is very damaging to living organisms. It is the weaker bonds in molecules that are of more interest to analysts because they can be excited by longer wavelength UV radiation > 200 nm (> 6.2 eV), which is at a longer wavelength than the region in which air and common solvents absorb. Examining a very simple organic molecule such as ethylene (Fig. 4.2) it can be seen that it contains two types of carbon-carbon bonds, a strong σ bond formed by extensive overlap of the sp^2 orbitals of the two carbons and a weaker π bond formed by partial overlap of the p orbitals of the carbon atoms. The σ bond would become excited and break when exposed to radiation at *ca* 150 nm. The weaker π bond requires less energetic radiation at *ca* 180 nm to produce the π^* excited state shown in Figure 4.2. This excitation can occur without the molecule falling apart since the σ orbitals remain unexcited by the longer wavelength radiation at 180 nm. However, a single double bond is still not useful as a chromophore for determining analytes by UV spectrophotometry since it is still in the region where air and solvents absorb.

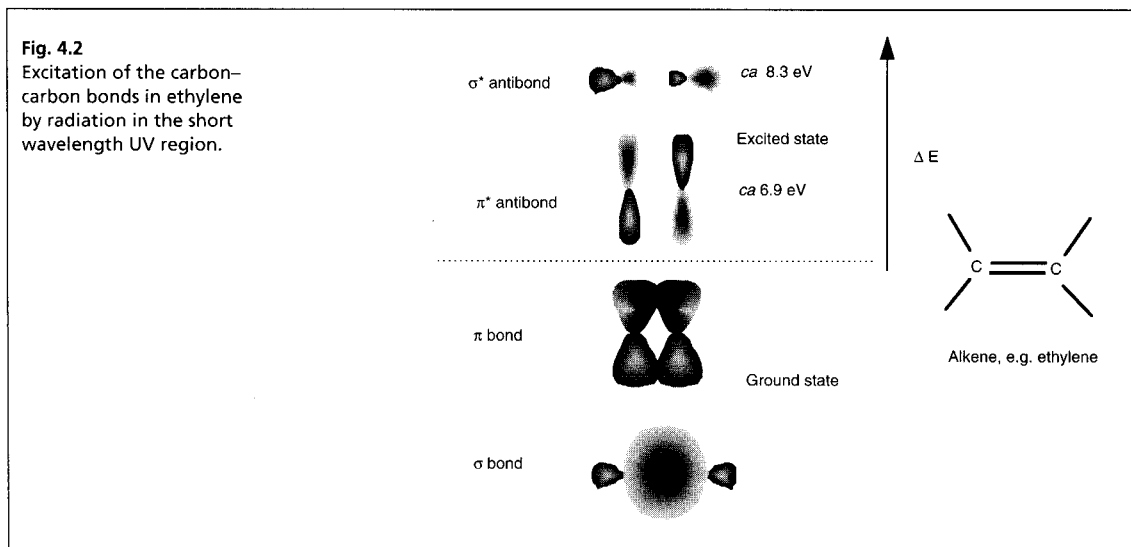

If more double bonds are present in a structure in conjugation (i.e. two or more double bonds in a series separated by a single bond) absorption takes place at longer wavelengths and with greater intensity as detailed in Table 4.1 for a series of polyenes. The A (1%, 1 cm) value, which is described later, gives a measure of the intensity of absorption. The type of linear conjugated system which is present in polyenes is not very common in drug molecules.





Such extended systems of double bonds are known as 'chromophores'. The most common chromophore found in drug molecules is a benzene ring (Table 4.2).

Table 4.1 Longest wavelength maxima and absorption intensities of some polyenes

Polyene	λ max	A (1%, 1 cm)
$\text{CH}_3(\text{CH}=\text{CH})_3\text{CH}_3$	275	2800
$\text{CH}_3(\text{CH}=\text{CH})_4\text{CH}_3$	310	6300
$\text{CH}_3(\text{CH}=\text{CH})_5\text{CH}_3$	342	9000
$\text{CH}_3(\text{CH}=\text{CH})_6\text{CH}_3$	380	9800

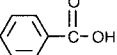
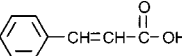
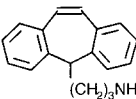
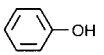
Benzene itself has its λ max at a much shorter wavelength than a linear triene such as hexatriene (λ max 275 nm) and its strongest absorbance is at the wavelength of absorption of an isolated double bond at 180 nm. It also has a strong absorption band at 204 nm. This is due to the symmetry of benzene; it is not possible to have an excited state involving all three bonds in benzene because this would mean that the dipole (polarisation of the chromophore), a two-dimensional concept which is created in the excited state, would be symmetrical and thus would have to exist in three dimensions rather than two. There is a weak absorption in the benzene spectrum close to the λ max for hexatriene and this can occur because vibration of the benzene ring in a particular direction can distort its symmetry and thus allow all three double bonds to be involved in an excited state. If the symmetry of the benzene ring is lowered by substitution, the bands in the benzene spectrum undergo a bathochromic shift – a shift to longer wavelength. Substitution can either involve extension of the chromophore or attachment of an auxochrome (a group containing one or more lone pair of electrons) to the ring or both. Table 4.2 summarises the absorption bands found in some simple aromatic systems and these chromophore/auxochrome systems provide the basis for absorption of UV radiation by many drugs. The hydroxyl group and amino group auxochromes are affected by pH undergoing bathochromic (moving to a longer wavelength) and hyperchromic (absorbing more strongly) shifts when a proton is removed under alkaline conditions,

Table 4.2 The UV absorption characteristics of some chromophores based on the benzene ring

Chromophore	Longest wavelength λ max	(A 1%, 1 cm)
 Benzene	255 nm	28
 Benzoic acid	273	85
 Cinnamic acid	273	1420
 Protriptyline	292	530
 \rightleftharpoons  Phenol	$270 \text{ nm} \rightleftharpoons 287 \text{ nm}$	$172 \rightleftharpoons 271$
 \rightleftharpoons  Aniline	$255 \text{ nm} \rightleftharpoons 286 \text{ nm}$	$16 \rightleftharpoons 179$
	Bathochromic	Hyperchromic
	Bathochromic	Hyperchromic

releasing an extra lone pair of electrons. The effect is most marked for aromatic amine groups. The absorption spectrum of a drug molecule is due to the particular combination of auxochromes and chromophores present in its structure.

Beer-Lambert Law

Figure 4.3 shows the absorption of radiation by a solution containing a UV-absorbing compound.

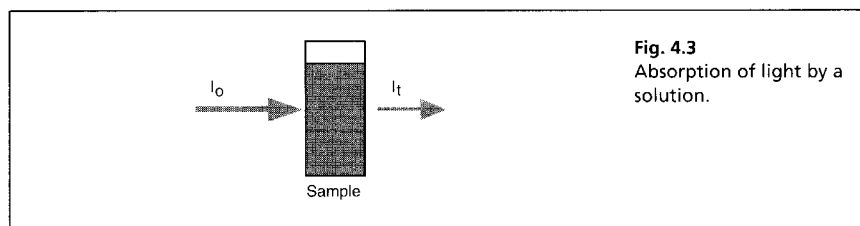

The measurement of light absorption by a solution of molecules is governed by the Beer-Lambert Law, which is written as follows:

$$\log I_0/I_t = A = \epsilon b c$$

where I_0 is the intensity of incident radiation, I_t is the intensity of transmitted radiation; A is known as the absorbance and is a measure of the amount of light absorbed by the sample; ϵ is a constant known as the molar extinction coefficient and is the absorbance of a 1M solution of the analyte, b is the pathlength of the cell in cm, usually 1 cm and c is the concentration of the analyte in moles liter⁻¹.

Self-test 4.1

Calculate the percentage of the incident radiation absorbed by a sample with an absorbance of (i) 2; (ii) 0.1.

Answers: (i) 99.0%; (ii) 20.6%

In pharmaceutical products, concentrations and amounts are usually expressed in grams or milligrams rather than in moles and thus for the purposes of the analysis of these products, the Beer-Lambert equation is written in the following form:

$$A = A(1\%, 1\text{ cm}) b c$$

A is the measured absorbance; $A(1\%, 1\text{ cm})$ is the absorbance of a 1% w/v (1 g/100 ml) solution in a 1 cm cell; b is the pathlength in cm (usually 1 cm); and c is the concentration of the sample in g/100 ml. Since measurements are usually made in a 1 cm cell the equation can be written:

$$c = \frac{A}{A(1\%, 1\text{ cm})} \text{ which gives the concentration of the analyte in g/100 ml}$$

BP monographs often quote a standard $A(1\%, 1\text{ cm})$ value for a drug which is to be used in its quantitation.

Self-test 4.2

What are the concentrations of the following solutions of drugs in g/100 ml and mg/100 ml?

- (i) Carbimazole, A (1%, 1 cm) value = 557 at 291 nm, measured absorbance 0.557 at 291 nm.
- (ii) Hydrocortisone sodium phosphate, A (1%, 1 cm) value 333 at 248 nm, measured absorbance 0.666 at 248 nm.
- (iii) Isoprenaline, A (1%, 1 cm) value = 100 at 280 nm measured absorbance 0.500 at 280 nm.

Answers: (i) Carbimazole 0.001 g/100 ml, 1 mg/100 ml; (ii) Hydrocortisone sodium phosphate 0.002 g/100 ml, 2 mg/100 ml; (iii) Isoprenaline: 0.005 g/100 ml, 5 mg/100 ml

Instrumentation

A simple diagram of a UV/visible spectrophotometer is shown in Figure 4.4. The components include:

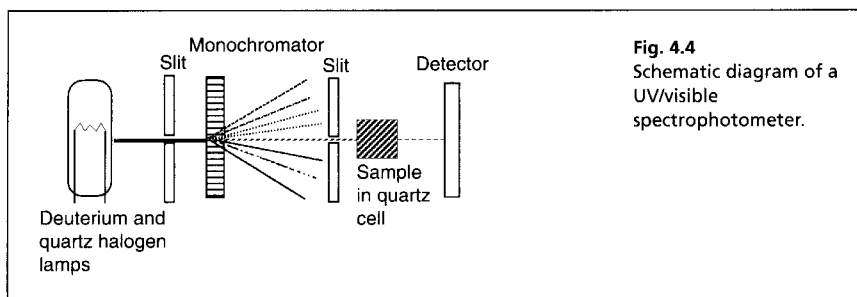

- (i) *The light sources* – a deuterium lamp for the UV region from 190–350 nm and a quartz halogen or tungsten lamp for the visible region from 350–900 nm.
- (ii) *The monochromator* – used to disperse the light into its constituent wavelengths which are further selected by the slit. The monochromator is rotated so that a range of wavelengths is passed through the sample as the instrument scans across the spectrum.
- (iii) *The optics* – may be designed to split the light beam so that the beam passes through two sample compartments and in such a double beam instrument, a blank solution can then be used in one compartment to correct the reading or spectrum of the sample. The blank is most commonly the solvent in which the sample is dissolved.

Instrument calibration

Pharmacopoeial monographs usually rely on standard A (1%, 1 cm) values in order to calculate the concentration of drugs in extracts from formulations. In order to use a standard value the instrument used to make the measurement must be properly calibrated with respect to its wavelength and absorption scales. In addition, checks for stray light and spectral resolution are run. These checks are now often built into the software of UV instruments so that they can be run automatically to ensure that the instrument meets good manufacturing practice requirements.

Calibration of absorbance scale

The British Pharmacopoeia (BP) uses potassium dichromate solution to calibrate the absorbance scale of a UV spectrophotometer, the A (1%, 1 cm) values at specified

wavelengths have to lie within the ranges specified by the BP. The spectrum of a 0.0065% w/v solution of potassium dichromate in 0.005 M H_2SO_4 is shown in Figure 4.5. The absorbance scale calibration wavelengths with corresponding A (1%, 1 cm) values for 0.0065% w/v potassium dichromate solution which are specified by the BP, are as follows: 235 nm (122.9–126.2), 257 nm (142.4–145.7), 313 nm (47.0–50.3), 350 nm (104.9–108.2).

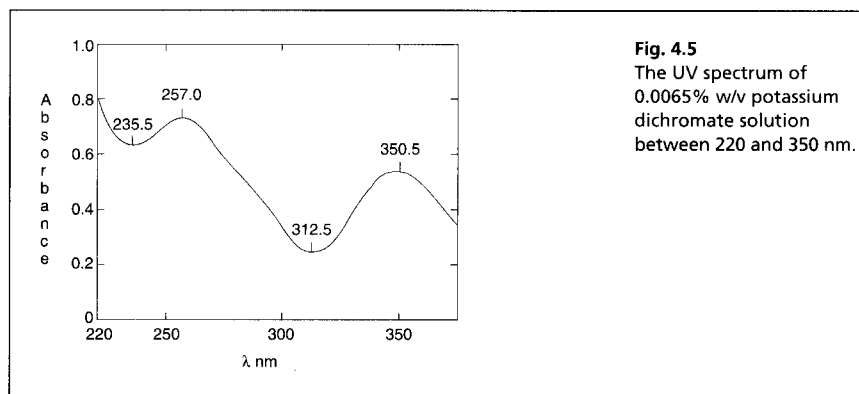

Fig. 4.5
The UV spectrum of 0.0065% w/v potassium dichromate solution between 220 and 350 nm.

Calibration of wavelength scale

The wavelength scale of a UV/visible spectrophotometer is checked by determining the specified wavelength maxima of a 5% w/v solution of holmium perchlorate. Figure 4.6 shows the spectrum of holmium perchlorate, the tolerances for calibration wavelengths specified by the BP are: 241.15 ± 1 nm, 287.15 ± 1 nm and 361.5 ± 1 nm.

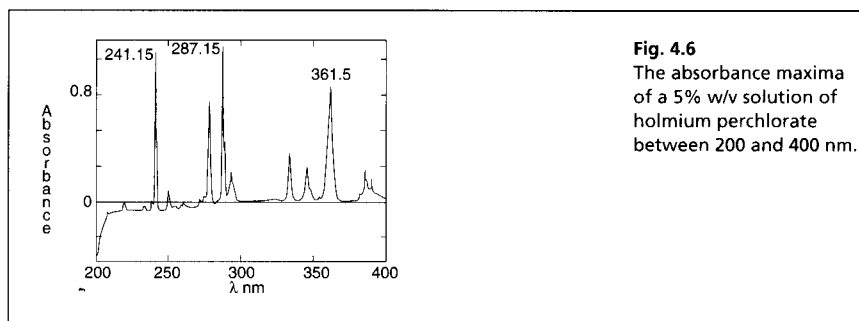

Fig. 4.6
The absorbance maxima of a 5% w/v solution of holmium perchlorate between 200 and 400 nm.

The wavelength scale may also be calibrated according to the spectral lines of deuterium or mercury discharge lamps and such tests may be built into some instruments.

Determination of instrumental resolution

The resolving power of an instrument is controlled by its slit width settings. For some pharmacopoeial tests a certain resolution is specified. The resolving power of an instrument can be assessed by using a 0.02% w/v solution of toluene in hexane. The BP specifies that the ratio of the absorbance for this solution at 269 nm to that at 266 nm should be at least 1.5.

Determination of stray light

Stray light is light which falls on the detector within a UV instrument without having passed through the sample. It can arise either from light scattering within the instrument or by entry of light into the instrument from outside. It gives a false low absorbance reading for the sample since it appears as though the sample is absorbing less light than it actually is. This is most serious where the sample has a high absorbance, e.g. at an absorbance of 2 the sample is absorbing most of the light passing through it and thus it would only require very low intensity stray light to lower the reading substantially. Stray light is checked by measuring the absorbance of a 1.2% solution of KCl in water against a water blank at a wavelength of 200 nm. If the absorbance of the sample is < 2 then stray light is present and the instrument needs to be serviced.

UV spectra of some representative drug molecules

Steroid enones

The chromophores of most drugs are based on a modification of the benzene ring chromophore. One large class of drugs that do not fit into this category are steroidal androgens and corticosteroids. The spectra of hydrocortisone and betamethasone are shown in Figure 4.7. These spectra are common to many steroids and all have absorbance maxima of similar intensity at around 240 nm. The extra double bond in betamethasone as compared with hydrocortisone does not make a great difference to the wavelength of maximum absorption since it does not extend the original chromophore linearly. However, the shape of the absorption band for betamethasone is quite different from that for hydrocortisone. Such differences in the spectra can be employed in qualitative identity tests; these are used particularly in conjunction with HPLC identification checks where the method of detection is by diode array UV spectrophotometry (Ch. 12 p. 250).

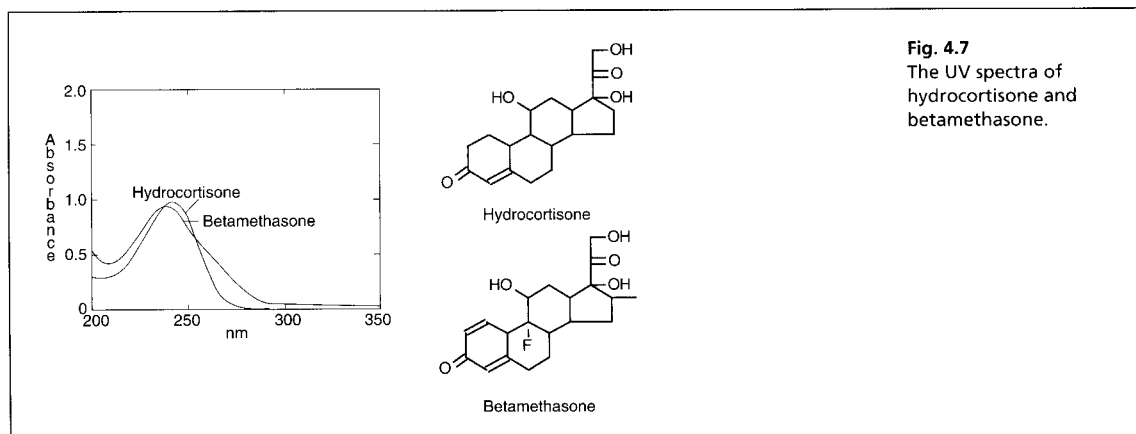

Table 4.3 summarises the absorption data for some steroid structures and illustrates the effect of molecular weight on the $A(1\%, 1\text{ cm})$ value. The strength of the enone chromophore is similar for all the steroids since the $A(1\%, 1\text{ cm})$ value is based on the absorption of a 1% w/v solution; it will thus decrease as the molecular weight of the steroid increases. This is of course true for all molecules.

Table 4.3 Absorption maxima for some corticosteroids

Steroid	Molecular weight	λ max	A (1%, 1 cm) value
Hydrocortisone	362.5	240	435
Betamethasone	392.5	240	390
Clobetasol butyrate	479.0	236	330
Betamethasone sodium phosphate	516.4	241	296

Ephedrine: the benzoid chromophore

Figure 4.8 shows the UV absorption spectrum of a 100 mg/100 ml solution of ephedrine. Ephedrine has the simplest type of benzene ring chromophore, which has a spectrum similar to that of benzene with a weak symmetry forbidden band *ca* 260 nm with an A (1%, 1 cm) value of 12. Like benzene its most intense absorption maximum is below 200 nm. There are no polar groups attached to or involved in the chromophore so that its vibrational fine structure is preserved because the chromophore does not interact strongly with the solvent.

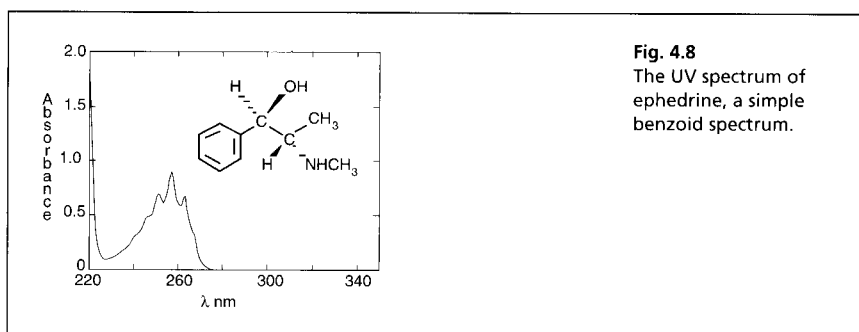

Fig. 4.8
The UV spectrum of ephedrine, a simple benzoid spectrum.

Drugs having a chromophore like that of ephedrine include: diphenhydramine, amphetamine, ibuprofen and dextropropoxyphene.

Ketoprofen: extended benzene chromophore

The spectrum of ketoprofen is shown in Figure 4.9. In this case the simple benzoid chromophore has been extended by four double bonds and thus the symmetry of the benzene ring has been altered. In addition, the strong absorbance band present in benzene at 204 nm has undergone a bathochromic shift giving a λ max for ketoprofen at 262 nm having an A (1%, 1 cm) value of 647.

Fig. 4.9
UV absorption spectrum of ketoprofen.

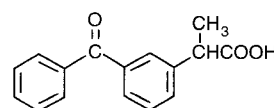
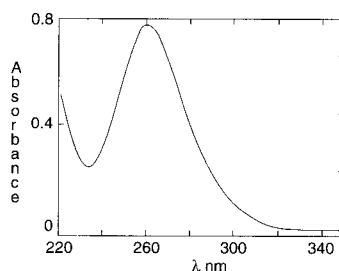

Ketoprofen

Other drugs which have an extended benzoid chromophore include: cyproheptadine, dimethindine, protriptyline, zimeldine.

Procaine: amino group auxochrome

Figure 4.10 shows the UV absorption spectra of a solution of procaine in 0.1 M HCl and 0.1M NaOH. In procaine, the benzene chromophore has been extended by addition of a C = O group and under acidic conditions, as in Figure 4.10, the molecule has an absorption at 279 nm with an A (1%, 1 cm) value of 100. In addition to the extended chromophore, the molecule also contains an auxochrome in the form of an amino group, which under basic conditions has a lone pair of electrons that can interact with the chromophore producing a bathochromic shift. Under acidic conditions the amine group is protonated and does not function as an auxochrome but when the proton is removed from this group under basic conditions a bathochromic shift is produced and an absorption with λ_{max} at 270 nm with an A (1%, 1 cm) value of 1000 appears.

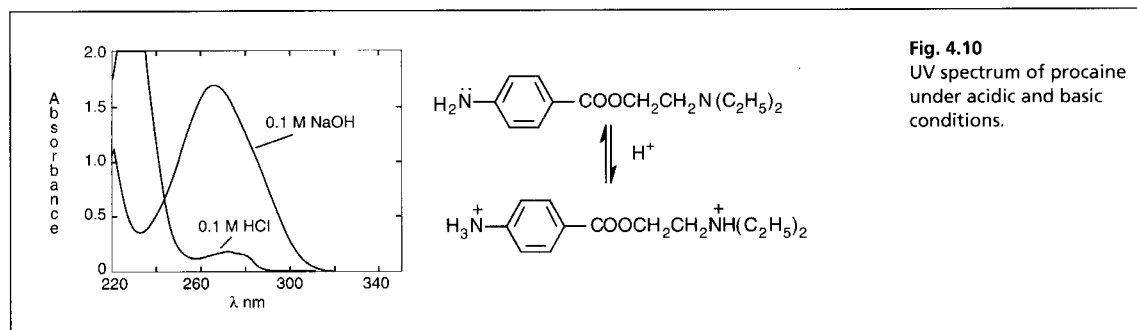

Drugs with a chromophore such as that of procaine include: procainamide and proxymetacaine. It should be noted that local anaesthetics such as bupivacaine and lignocaine do not fall into this category since they are aromatic amides and the lone pair on the nitrogen atom is not fully available due to electron withdrawal by the adjacent carbonyl group.

Phenylephrine: hydroxyl group auxochrome

The chromophore of phenylephrine is not extended but its structure includes a phenolic hydroxyl group. The phenolic group functions as an auxochrome under both acidic and alkaline conditions. Under acidic conditions it has two lone pairs of electrons, which can interact with the benzene ring and under basic conditions it has three. Figure 4.11 shows the bathochromic and hyperchromic shift in the spectrum of phenylephrine, which occurs when 0.1 M NaOH is used as a solvent instead of 0.1 M HCl. Under acidic conditions the λ_{max} is at 273 nm and has an A (1%, 1 cm) value of 110 and under alkaline conditions the λ_{max} is at 292 nm and has an A (1%, 1 cm) value of 182.

The types of shifts observed for procaine and phenylephrine can be exploited in order to achieve analysis of mixtures. Two examples of this are given later in the chapter.

Fig. 4.11
UV spectrum of phenylephrine under acidic and basic conditions.

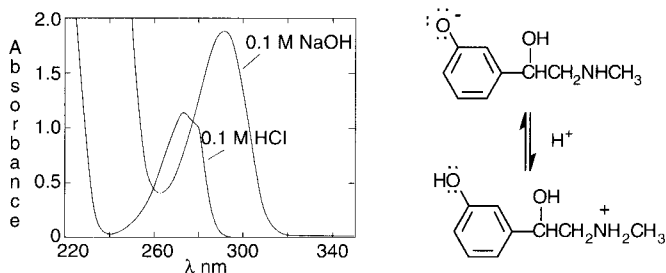

Use of UV/visible spectrophotometry to determine pK_a values

Where a pH-dependent UV shift is produced, it is possible to use it to determine the pK_a of the ionisable group responsible for the shift. In the case of phenylephrine, the pK_a value of the phenolic group can be determined conveniently from the absorbance at 292 nm since the absorbance of the molecular species where the phenolic group is un-ionised is negligible at this wavelength. This is not the case for all molecules. A general equation for determination of pK_a from absorbance measurement at a particular wavelength is given below.

The following equation can be used for an acid (for a base the log term is subtracted) where increasing pH produces a bathochromic/hyperchromic shift:

$$pK_a = pH + \log \frac{A_i - A}{A - A_u}$$

where A is the measured absorbance in a buffer of known pH at the wavelength selected for analysis, A_i is the absorbance of the fully ionised species and A_u is the absorbance of the un-ionised species.

The wavelength used for analysis is one where there is the greatest difference between the ionised and un-ionised species. An approximate knowledge of the pK_a value is required to select a suitable pH value, within ± 1 of the pK_a value, for measurement of A . For accurate determination measurement is made at a number of closely spaced pH values.

It should be noted that if the acid or base undergoes a shift to lower absorbance and shorter wavelength with increasing pH the log term above is subtracted; this situation is less common in drug molecules.

Calculation example 4.1

The absorbance of a fixed concentration of phenylephrine at 292 nm is found to be 1.224 in 0.1 M NaOH and 0.02 in 0.1 M HCl. Its absorbance in buffer at pH 8.5 is found to be 0.349. Calculate the pK_a value of its acidic phenolic hydroxyl group.

$$pK_a = 8.5 + \log \frac{1.224 - 0.349}{0.349 - 0.02} = 8.5 + 0.402 = 8.902.$$

Self-test 4.3

Calculate the pK_a value of the weakly basic aromatic amine in procaine from the data given below. Absorbance of a fixed concentration of procaine in: 1 M HCl at 296 nm = 0.031; absorbance in 0.1 M NaOH = 1.363; absorbance in buffer at pH 2.6 = 0.837.

Answer: 2.41

Applications of UV/visible spectroscopy to pharmaceutical quantitative analysis

Introduction

Pharmacopoeial methods rely heavily on simple analysis by UV/visible spectrophotometry to determine active ingredients in formulations. These methods are usually based on the use of a standard *A* (1%, 1 cm) value for the active ingredient being assayed and this relies on the UV spectrophotometer being accurately calibrated as described earlier in the chapter. Such methods also presume that there is no interference from excipients (preservatives, colourants, etc.) present in formulations and that the sample is free of suspended matter, which would cause light scattering.

Assay examples

Frusemide in tablet form

A typical example of a straightforward tablet assay is the analysis of frusemide tablets:

- (i) Tablet powder containing *ca* 0.25 g of frusemide is shaken with 300 ml of 0.1 M NaOH to extract the acidic frusemide.
- (ii) The extract is then made up to 500 ml with 0.1 M NaOH.
- (iii) A portion of the extract is filtered and 5 ml of the filtrate is made up to 250 ml with 0.1 M NaOH.
- (iv) The absorbance of the diluted extract is measured at 271 nm.
- (v) The *A* (1%, 1 cm) value at 271 is 580 in basic solution.

From the data below calculate the % of stated content in a sample of frusemide tablets:

- Stated content per tablet: 40 mg of frusemide
- Weight of 20 tablets: 1.656 g
- Weight of tablet powder taken for assay: 0.5195 g
- Absorbance reading: 0.596 (see Calculation example 4.2).

Assay of cyclizine lactate in an injection

The steps in this assay are more difficult to follow since a number of extractions take place prior to preparing the final dilution in order to remove excipients:

- (i) Dilute 5 ml of injection to 100 ml with 1 M sulphuric acid.
- (ii) Add 2 g of sodium chloride to 20 ml of this solution and shake with two 50 ml quantities of ether.

Calculation example 4.2

Expected content in tablet powder taken: $\frac{0.5195}{1.656} \times 40 \times 20 = 251.0 \text{ mg}$.

Dilution factor

5 – 250 ml = 50.

Concentration in diluted tablet extract: $\frac{0.596}{580} = 0.001028 \text{ g/100 ml} = 1.028 \text{ mg/100 ml}$.

Concentration in original tablet extract: $1.028 \times 50 = 51.40 \text{ mg/100ml}$.

Volume of original extract: 500 ml.

Therefore amount of frusemide in original extract: $51.40 \times 5 = 257.0$.

Percentage of stated content: $\frac{257.0}{251.0} \times 100 = 102.4\%$.

Self-test 4.4

Calculate the percentage of stated content of promazine hydrochloride in promazine tablets from the following information:

- (i) Tablet powder containing ca 80 mg of promazine hydrochloride is ground to a paste with 10 ml of 2 M HCl.
- (ii) The paste is then diluted with 200 ml of water, shaken for 15 min and finally made up to 500 ml.
- (iii) A portion of the extract is filtered.
- (iv) 5 ml of the filtrate is taken and diluted to 100 ml with 0.1 M HCl.
- (v) The absorbance is read at a wavelength of 251 nm.
 - A (1%, 1 cm) value of promazine.HCl at 251 nm = 935
 - Stated content of promazine.HCl per tablet = 50 mg
 - Weight of 20 tablets = 1.667 g
 - Weight of tablet powder taken for assay = 0.1356 g
 - Absorbance reading = 0.755.

Answer: Percentage of stated content = 99.3

- (iii) Add 20 ml of 5 M sodium hydroxide and extract with three 50 ml quantities of ether.
- (iv) Combine the ether extracts and then wash with two 10 ml quantities of a saturated solution of sodium chloride.
- (v) Extract the ether layer with two 25 ml quantities of 0.05 M sulphuric acid and then with two 10 ml quantities of water.
- (vi) Combine the acidic and aqueous extracts and dilute to 100 ml with water.
- (vii) Dilute 5 ml of this solution to 200 ml with 0.05 M sulphuric acid and measure the absorbance of the resulting solution at 225 nm.

Calculate the percentage of w/v of cyclizine lactate in the injection from the following information:

- A (1%, 1 cm) of cyclizine lactate at 225 nm = 331
- Volume of injection assayed = 5 ml
- Measured absorbance = 0.413
- Measurements were made in a 1 cm cell.

Calculation example 4.3

The first dilution is 5 ml to 100 ml ($\times 20$). Then 20 ml of this dilution is taken and extracted with ether to remove excipients, the cyclizine remains in the acidic water layer since it is a base. After extraction with ether the acidic layer is basified and the cyclizine is extracted into ether; it is then back extracted into 0.1 M sulphuric acid and made up to 100 ml, thus the dilution factor in the second step is 20 to 100 ml ($\times 5$). Finally a third dilution is carried out in which 5 ml of the second dilution are diluted to 200 ml ($\times 40$).

Total dilution: $20 \times 5 \times 40 = 4000$.

For the diluted injection c: $\frac{0.413}{331} = 0.001248 \text{ g/100 ml}$.

Concentration in original solution: $0.001248 \times 4000 = 4.992 \text{ g/100 ml}$.

Concentration of injection = 4.992% w/v.

Self-test 4.5

Determine the concentration of the following injections:

Isosuprine injection is diluted as follows:

- (i) Diluted 10 ml of injection to 100 ml and then 10 ml of the dilution to 100 ml.
 - Absorbance reading at 274 nm = 0.387
 - A (1%, 1 cm) value at 274 nm = 73.

Haloperidol injection:

- (i) Add 15 ml of 1 M HCl to 5 ml of injection.
- (ii) Extract three times with ether washing the ether extracts with 10 ml of water.
- (iii) Combine the aqueous layers and dilute to 100 ml.
- (iv) Take 10 ml of the diluted aqueous solution and dilute to 100 ml.
 - Absorbance reading at 245 nm = 0.873
 - A (1%, 1 cm) value at 245 nm = 346.

Answers: Isosuprine injection = 0.530% w/v; haloperidol injection = 0.505% w/v

Assay of penicillins by derivatisation (Fig. 4.12)

Fig. 4.12
Reaction of penicillins with mercury imidazole reagent.

The BP utilises formation of a derivative in order to quantify penicillins in formulations. Some penicillins do not have distinctive chromophores; a further problem with these molecules is that when they are in suspensions they are not readily extracted away from excipients since they are quite insoluble in organic solvents which are immiscible with water. Using the formation of a complex with the mercuric ion in the presence of imidazole as a catalyst, a derivative of the penicillin structure is produced, which has an absorption maximum between 325 and 345 nm. In the assay, comparison with pure standard for the particular penicillin is carried out rather than relying on a standard A(1%, 1 cm) value. This assay is used by the BP for

analysis of preparations containing ampicillin, amoxycillin, carbenicillin, cloxacillin, flucloxacillin and phenoxymethylpenicillin. The assay is not used for the closely related cephalosporins.

Calculation example 4.4

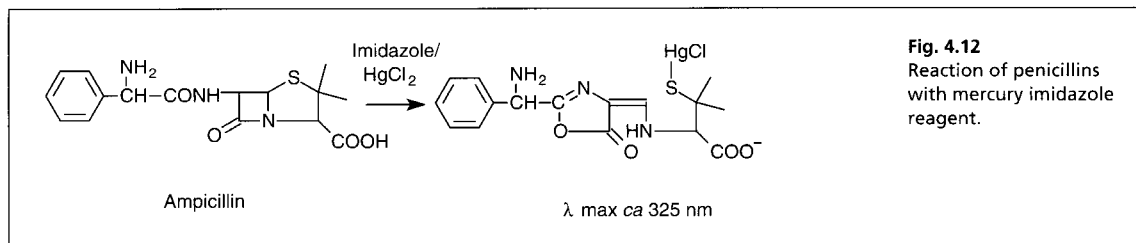
Cloxacillin injection is assayed using the mercury–imidazole reaction in comparison with a cloxacillin standard.

The sample and standard were both diluted in 500 ml of water and then 25 ml was taken from each of the solutions and was made up to 100 ml. 2 ml of the sample and standard solutions were then reacted with mercury–imidazole reagent. From the data below calculate the amount of cloxacillin per vial.

Weight of the content of 10 vials = 2.653 g.

Weight of injection powder used for assay = 0.1114 g.

Weight of cloxacillin sodium standard used in calibration solution = 0.1015 g.

Absorbance of sample solution = 0.111.

Absorbance of standard solution = 0.106.

In this calculation the dilutions can be ignored since:

Weight of cloxacillin in sample = $\frac{\text{Absorbance sample}}{\text{Absorbance of standard}} \times \text{weight of standard}$

Weight of cloxacillin in sample $\frac{0.111}{0.106} \times 0.1015 = 0.1063$ g.

Contents of 1 vial $\frac{2.653}{10} = 0.2653$ g.

Amount of cloxacillin in 1 vial $\frac{0.2653}{0.1114} \times 0.1063 = 0.2532$ g.

Assay of adrenaline in lignocaine adrenaline injection

Adrenaline is present as a vasoconstrictor in some local anaesthetic injections in a much smaller amount than the local anaesthetic itself, which obscures the absorption of adrenaline in the UV region. The selectivity of UV/visible spectroscopy for the analysis of adrenaline can be increased by complex formation, which occurs between iron (II) and molecules containing a catechol group (Fig. 4.13). These complexes are purple in colour and absorb at *ca* 540 nm at much longer wavelengths than for instance local anaesthetics, which do not form such complexes. The adrenaline in the injection is quantified against a standard solution of adrenaline.

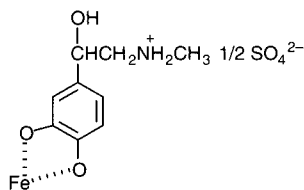

Adrenaline iron (II) complex

Fig. 4.13

The complex formed between adrenaline and iron, which is used to analyse adrenaline at low levels in an injection.

Self-test 4.6

Adrenaline in bupivacaine/adrenaline injection is assayed by complex formation with iron (II). 20 ml of the injection is mixed with 0.2 ml of reagent and 2 ml of buffer and a reading is taken in a 4 cm pathlength cell. A reading of a solution containing 5.21 $\mu\text{g/ml}$ of adrenaline is taken under the same conditions.

The following results were obtained:

- Absorbance of sample = 0.173
- Absorbance of standard solution = 0.181

Calculate the percentage of w/v of adrenaline in the injection.

Answer: 0.005% w/v

Difference spectrophotometry

In difference spectroscopy, a component in a mixture is analysed by carrying out a reaction which is selective for the analyte. This could be simply bringing about a shift in wavelength through adjustment of the pH of the solution in which the analyte is dissolved or a chemical reaction such as oxidation or reduction. In the following example the selective alkaline shift of aspirin is used to determine it in a preparation also containing dextropropoxyphene, naphthalene sulphonic acid and caffeine. Caffeine, dextropropoxyphene and the naphthalene sulphonic acid anion do not undergo appreciable alkaline shifts whereas aspirin does. Figure 4.14A shows the spectrum of the extract from tablets in 0.1 M HCl – in fact there is relatively minor interference at the wavelength used for the determination of aspirin but by using the sample in HCl in place of a blank in the reference cell one can be sure that interference from the excipients is eliminated. Figure 4.14B shows the difference spectrum with the capsule extract in 0.1 M HCl in the reference cell and the capsule extract in 0.1 M NaOH in the sample cell. The absorbance at 299 nm is thus wholly due to aspirin. The problem remains of how to quantify the analyte in such a sample. This can be readily carried out using standard additions which involves adding a known amount of aspirin standard to the sample and comparing the absorbance of the original sample extract with the absorbance of the spiked sample.

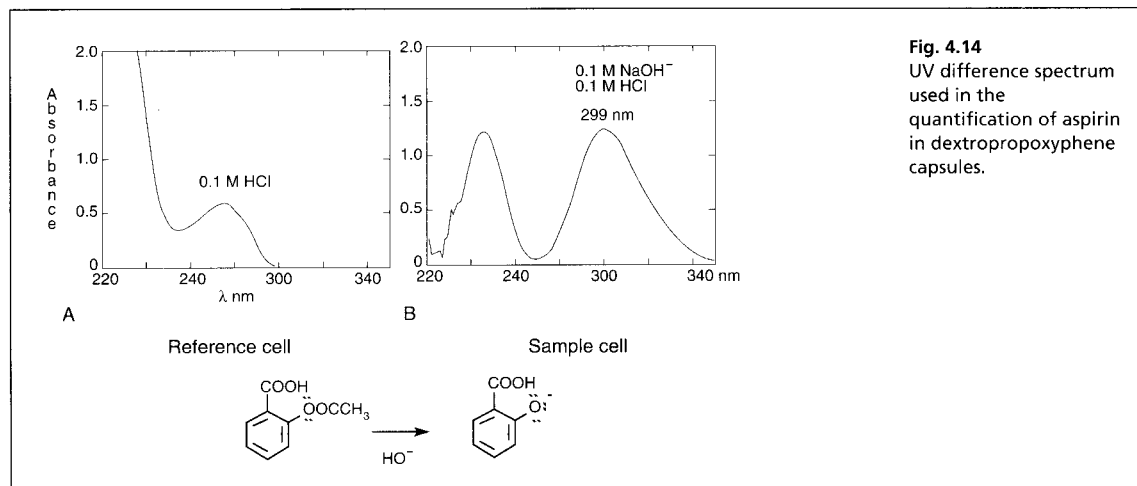

Analysis of aspirin in dextropropoxyphene compound tablets

Analysis was carried out by difference spectrophotometry. A one-point standard calibration for the determination of aspirin in dextropropoxyphene compound capsules was prepared by adding a known amount of aspirin to the sample from a standard stock solution. Stated content in the capsules:

- Aspirin 250 mg
 - dextropropoxyphene napsylate 100 mg
 - caffeine 30 mg.
- (i) 5 ml of the solution of sample in methanol is diluted to 500 ml with 0.1 M HCl: Reference solution.
 - (ii) 5 ml of the solution of sample in methanol is diluted to 500 ml with 0.1 M NaOH.
 - (iii) 5 ml of the solution of sample solution in methanol and 5 ml of aspirin standard solution were mixed and then diluted to 500 ml with 0.1 M NaOH.

Readings were taken at 299 nm of the sample solutions with and without standard addition against the reference solution prepared by diluting the sample extract with 0.1 M HCl.

The following data were obtained:

- Weight of contents of 20 capsules = 10.556 g
- Weight of capsule content analysed = 0.1025 g
- Capsule contents were dissolved in methanol and adjusted to 100 ml
- Concentration of aspirin standard solution = 50.4 mg/100 ml
- Absorbance of sample at 299 nm in 0.1 M NaOH without standard addition = 0.488
- Absorbance of sample at 299 nm in 0.1 M NaOH with standard addition = 0.974.

Calculation example 4.5

In dilution (iii) aspirin standard solution is diluted 5 ml to 500 ml ($\times 100$).

Concentration of aspirin standard in standard addition solution: $\frac{50.4}{100} = 0.504$ mg/100 ml.

The difference between the absorbance with standard addition and that without represents the absorbance due to a 0.504 mg/100 ml solution of aspirin.

Absorbance difference: $0.974 - 0.488 = 0.486$.

Therefore concentration of aspirin in the sample solution = $\frac{0.488}{0.486} \times 0.504 = 0.506$ mg/100 ml.

Dilution factor for sample = 5 ml to 500 ml ($\times 100$).

Concentration of aspirin in undiluted sample solution = $0.506 \times 100 = 50.6$ mg/100 ml.

Volume of initial extract = 100 ml.

Therefore amount of aspirin extracted from the capsule powder = 50.6 mg.

Amount expected in capsule powder analysed = $250 \times 20 \times \frac{0.1025}{10.556} \times 1000 = 48.6$ mg.

Therefore percentage of stated content = $\frac{50.6}{48.6} \times 100 = 104.1$.

Derivative spectra

Derivative spectra can be used to clarify absorption bands in more complex UV spectra. The technique is used extensively in the rapidly developing field of near infrared spectrophotometry (see Ch. 5) and can also be applied in the determination of the purity of chromatographic peaks when they are monitored by diode array detection. The main effect of derivatisation is to remove underlying broad absorption bands where there is only a gradual change in slope. The first derivative spectrum is obtained by plotting, for instance, the slopes of 2 nm segments of the spectrum and this results, as shown for a Gaussian band in Figure 4.15, in a spectrum where the slope is zero at the maximum of the peak and the slope is maximum at approximately half the peak height. In the second derivative spectrum the slopes of adjacent 2 nm segments are compared and this gives the points of maximum curvature of the spectrum. The rate of curvature of a spectrum has its greatest negative value at its maximum and the greatest rates of curvature are observed for narrow absorption bands. Figure 4.15 shows the first, second, third and fourth derivatives of a Gaussian band.

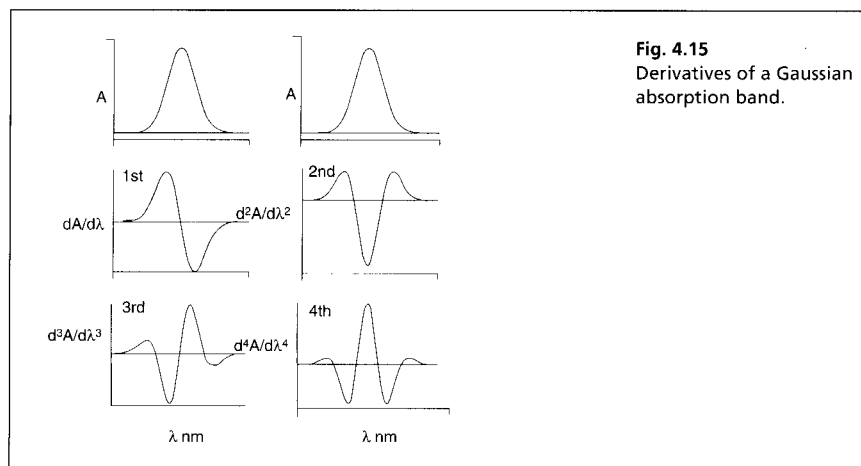
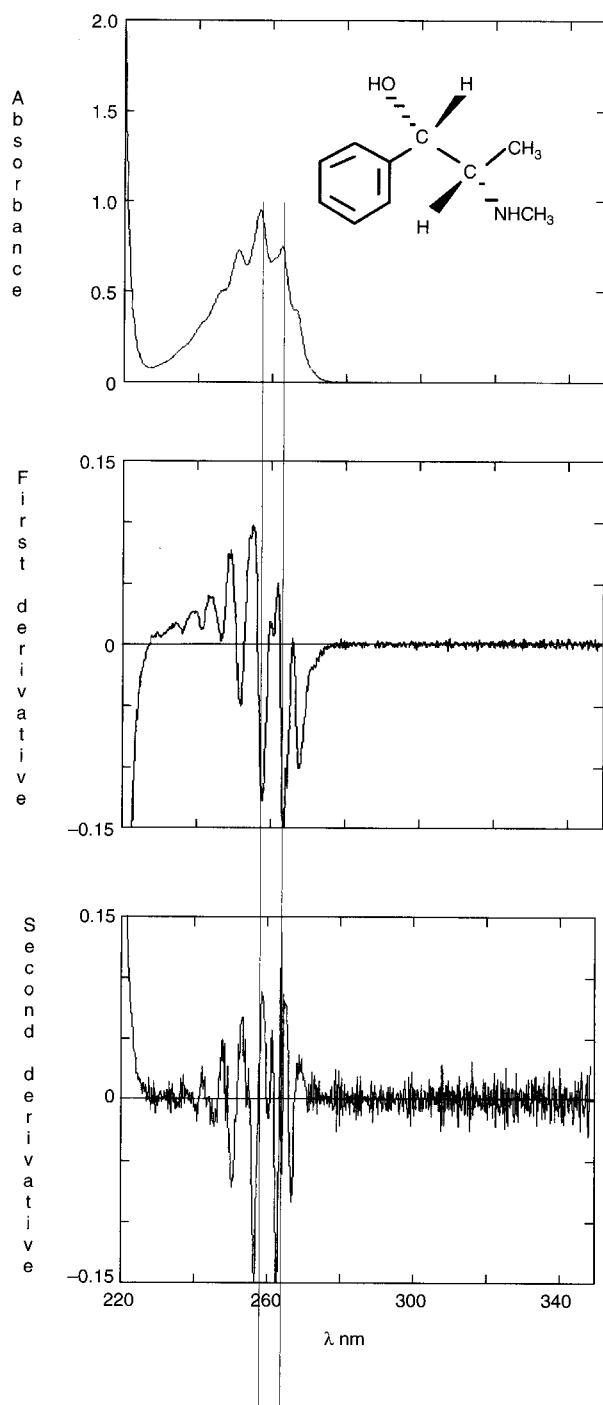

Fig. 4.15
Derivatives of a Gaussian
absorption band.

As would be expected, the first order spectrum of pseudoephedrine, shown in Figure 4.16, gives maxima at the points where the slope is at a maximum in the zero order spectrum. In addition, the second order spectrum gives minima corresponding to the maxima in the zero order spectrum, i.e. where the negative curvature of the spectrum is at its maximum.

By examining the UV spectrum of an elixir containing pseudoephedrine, dextromethorphan and triprolidine (30 mg, 10 mg and 1.25 mg, respectively) shown in Figure 4.17, it can be seen that the pseudoephedrine spectrum lies on top of a large background due to dextromethorphan and triprolidine, which have much stronger chromophores than pseudoephedrine. However, the underlying slope of the absorption curve due to contributions from dextromethorphan and triprolidine is shallow. The steepest underlying increase is due to dextromethorphan, which reaches a maximum at 278 nm. When the second derivative spectrum is examined it can be seen that the only peaks derive from pseudoephedrine and even where the dextromethorphan makes its maximum contribution at 278 nm there is little absorption in the second derivative spectrum. Thus it would be possible to use the

Fig. 4.16
UV spectrum of
pseudoephedrine with its
first and second
derivative spectra. The
minima correspond to
the maxima in the
absorbance spectrum.



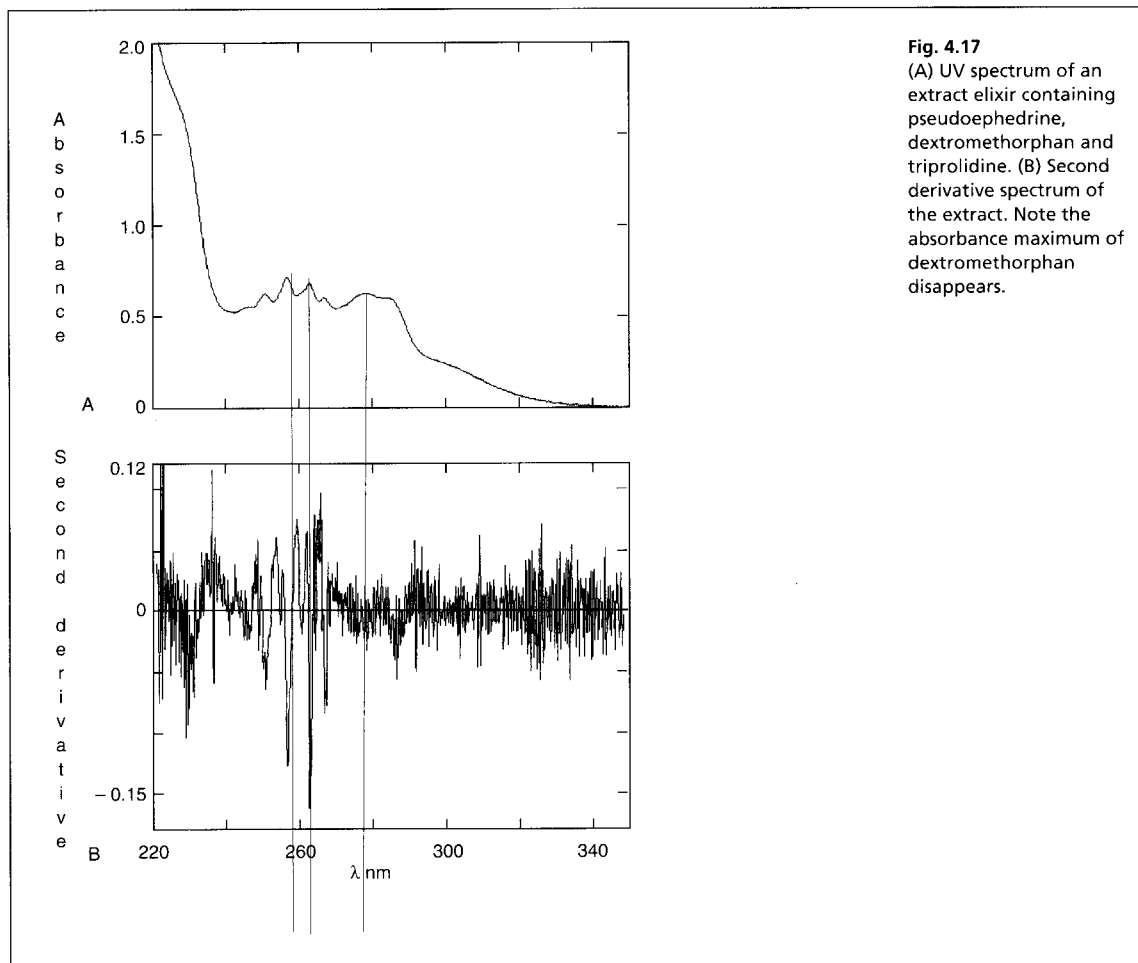

Fig. 4.17
 (A) UV spectrum of an extract elixir containing pseudoephedrine, dextromethorphan and triprolidine. (B) Second derivative spectrum of the extract. Note the absorbance maximum of dextromethorphan disappears.

height of the pseudoephedrine peak to determine the amount of pseudoephedrine in the elixir with suitable calibration, e.g. standard additions of pseudoephedrine to the sample extract.

The signal:noise ratio is poorer in the second derivative spectra because through dividing the spectrum into segments in order to calculate the derivative the underlying noise is less efficiently averaged out, which occurs when the spectrum is scanned in much narrower segments.

Applications of UV/visible spectroscopy in preformulation and formulation

UV/visible spectrophotometry is a standard method for determining the physico-chemical properties of drug molecules prior to formulation and for measuring their release from formulations. The type of properties which can be usefully determined by the UV method are listed as follows.

Partition coefficient

The partition coefficient of a drug between water and an organic solvent may be determined by shaking the organic solvent and the water layer together and determining the amount of drug in either the aqueous or organic layer by UV spectrophotometry. If buffers of different pH values are used, the variation of partition coefficient with pH may be determined and this provides another means of determining the pK_a value of a drug.

Solubility

The solubility of a drug in, for instance, water may be simply determined by shaking the excess of the drug in water or buffer until equilibrium is reached and then using UV spectrophotometry to determine the concentration of the drug that has gone into solution. Another method for determining solubility, where an ionisable group is present in the drug, is to dissolve varying concentrations of the salt of the drug in water and then add excess acid to a solution of the salt of an acidic drug or excess base to a solution of the salt of the basic drug, thus converting the drugs into their un-ionised forms. When the solubility of the un-ionised drug in water is exceeded, a cloudy solution will result and UV spectrophotometry can be used to determine its degree of turbidity by light scattering, which can be measured at almost any wavelength, e.g. 250 nm.

Release of a drug from a formulation

UV spectrophotometry is used routinely to monitor *in vitro* release of active ingredients from formulations. For simple formulations the drug is simply monitored at its λ_{max} . In the example shown in Figure 4.18 the rate release of pseudoephedrine from a controlled release formulation was monitored.¹ The release of the drug was followed by monitoring its release into distilled water using a UV spectrophotometer set at 206 nm. In the example given in Figure 4.18 the particle size of the ethylcellulose used in the formulation affected the rate of release.

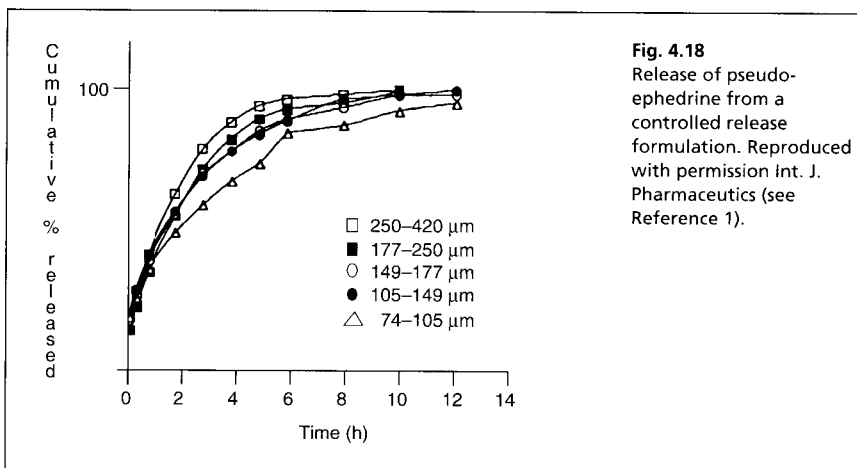

Fig. 4.18
Release of pseudoephedrine from a controlled release formulation. Reproduced with permission *Int. J. Pharmaceutics* (see Reference 1).

If UV-absorbing excipients were present in such a formulation the UV wavelength used for monitoring release would need to be selected carefully or high-pressure liquid chromatography (HPLC) coupled to UV detection might be used. For such studies the sampling of the dissolution medium may be fully automated so that the medium is filtered and pumped through to the UV spectrophotometer at set time intervals in order to take a reading.

References

1. P.R. Kaitikaneni, S.M. Upadrashta, S.N. Neau and A.K. Mitra. *Int. J. Pharmaceutics* 123, 119–125 (1995).

Further reading

- Practical Pharmaceutical Chemistry. Part 2, 4th Edn. A.H. Beckett and J.B. Stenlake. Athlone Press (1988).
- Techniques in Visible and Ultraviolet Spectrometry Vol. 4. B.J. Clark, T. Frost and M.A. Russell. Chapman and Hall (1993).

5

Infrared spectrophotometry

Keypoints**Introduction****Factors determining intensity and energy level of absorption in IR spectra**

Intensity of absorption

Energy level of absorption

Instrumentation

Instrument calibration

Sample preparation**Application of IR spectrophotometry in structure elucidation****Examples of IR spectra of drug molecules****IR spectrophotometry as a fingerprint technique**

Preparation of samples for fingerprint determination

Near-infrared analysis (NIRA)**Keypoints****Introduction****Examples of NIRA applications**

Determination of particle size in United States Pharmacopoeia (USP) grade aspirin

Determination of blend uniformity

Determination of multicomponent dosage forms

In-pack determination of active ingredients

Determination of polymorphs

Moisture determination

Process control of components in a shampoo

Additional problems**KEYPOINTS****Principles**

- Electromagnetic radiation ranging between 500 cm^{-1} and 4000 cm^{-1} (2500 and 20 000 nm) is passed through a sample and is absorbed by the bonds of the molecules in the sample causing them to stretch or bend. The wavelength of the radiation absorbed is characteristic of the bond absorbing it.

Applications

- A qualitative fingerprint check for the identity of raw material used in manufacture and for identifying drugs.
- Used in synthetic chemistry as a preliminary check for compound identity particularly for the presence or absence of a carbonyl group, which is difficult to check by any other method.
- Can be used to characterise samples in the solid and semi-solid states such as creams and tablets.
- Used as a fingerprint test for films, coatings and packaging plastics.
- Can be used to detect polymorphs of drugs (polymorphs are different crystal forms of a molecule that have different physical properties such as solubility and melting point which may be important in the manufacturing process).

Strengths

- Provides a complex fingerprint which is unique to the compound being examined.

- Computer control of instruments means that matching of the spectrum of a compound to its standard fingerprint can now be readily carried out.

Limitations

- Rarely used as a quantitative technique because of relative difficulty in sample preparation and the complexity of spectra.
- Usually can only detect gross impurities in samples.
- Sample preparation requires a degree of skill, particularly when potassium bromide (KBr) discs are being prepared.
- The technique is lacking in robustness since sample handling can have an effect on the spectrum obtained and thus care has to be taken in sample processing.

Introduction

The infra region can be divided up as shown in Table 5.1.

Table 5.1 Infrared ranges

Ranges	Far infrared	Middle infrared	Near infrared
Wavelength range	50–1000 μm	2.5–50 μm	0.8–2.5 μm
Wave number range	200–10 cm^{-1}	4000–200 cm^{-1}	12 500–4000 cm^{-1}
Energy range	0.025 eV–0.0012 eV	0.5 eV–0.025 eV	1.55 eV–0.5 eV

The middle infrared region is commonly used for structural confirmation but near infrared spectrophotometry, which has been used for very many years to control the products such as flour and animal feed, is finding increasing applications in quality control in the pharmaceutical industry. For the purposes of explaining infrared spectroscopy, a molecule is viewed as being joined by bonds which behave like springs. If the simple molecule HCl is examined in the gas phase it can be seen that it has an absorbance maximum at *ca* 2900 cm^{-1} , which results from the transition between the bottom vibrational state V_0 and the first excited state V_1 (Fig. 5.1). The spacing of the lower vibrational levels in IR spectrophotometry is equal so that even if the V_1 – V_2 transition occurred the energy absorption would be the same as for V_0 – V_1 . Quantum mechanics does not allow a V_0 – V_2 transition, although these types of transition over 2 or 3 levels occur weakly and give rise to near-infrared spectra.

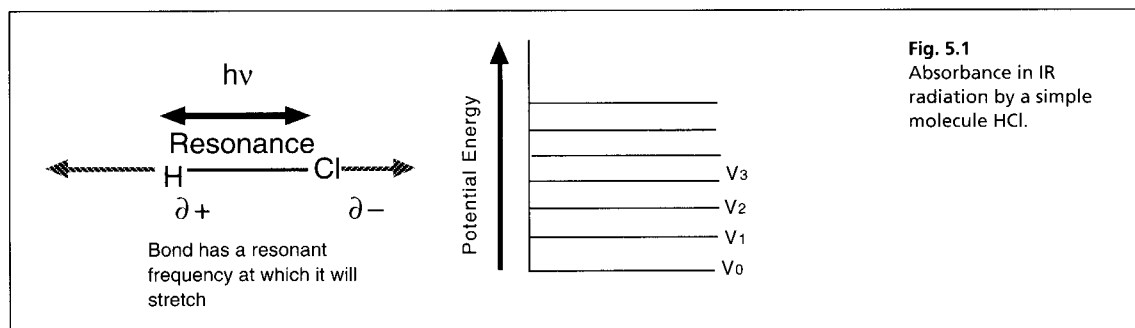
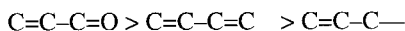

Fig. 5.1 Absorbance in IR radiation by a simple molecule HCl.

In order for the electrical component in electromagnetic radiation to interact with a bond, the bond must have a dipole. Thus symmetrical bonds such as those in O_2 or N_2 do not absorb infrared radiation. However, the majority of organic molecules have plenty of asymmetry. In even small organic molecules the modes of vibration are complex. This is illustrated by the vibrational modes which can occur in a

The order of intensity is as follows:



Energy level of absorption

The equation which determines the energy level of vibration of a bond is shown below:

$$E_{\text{vib}} \propto \sqrt{\frac{k}{\mu}}$$

k is a constant related to the strength of the bond, e.g. double bonds are stronger than single bonds and therefore absorb at a higher energy than single bonds. μ is related to the ratio of the masses of the atoms joined by the bond.

$$\mu = \frac{m_1 m_2}{m_1 + m_2}$$

e.g. for O—H bonds $\mu = \frac{16 \times 1}{17} = 0.94$ for C—O bonds $\mu = \frac{12 \times 16}{17} = 11.3$

where m_1 and m_2 are the masses of the atoms involved in the bond.

According to the μ term the highest energy bonds are the X—H (OH, NH, CH). The order of energy absorption for some common bonds is as follows, which reflects μ and the strength of the bonds:



Instrumentation

Two types of instrument are commonly used for obtaining IR spectra: dispersive instruments which use a monochromator to select each wavenumber in turn in order to monitor its intensity after the radiation has passed through the sample and Fourier transform instruments that use an interferometer. The latter generates a radiation source in which individual wavenumbers can be monitored within a *ca* 1 s pulse of radiation without dispersion being required. In recent years, Fourier transform instruments have become very common. A simple diagram of the layout of a continuous wave instrument is shown in Figure 5.3. The actual arrangement of the optics is much more complicated than this but the diagram shows the essential component parts for a dispersive IR instrument. The filament used is made of metal oxides, e.g. zirconium, yttrium and thorium oxides and is heated to incandescence in air. The sample is contained in various ways within discs or cells made of alkali metal halides. Once the light has passed through the sample it is dispersed so that an individual wavenumber or small number of wavenumbers can be monitored in turn by the detector across the range of the spectrum.

In a Fourier transform IR instrument the principles are the same except that the monochromator is replaced by an interferometer. An interferometer uses a moving mirror to displace part of the radiation produced by a source (Fig. 5.4) thus producing an interferogram which can be transformed using an equation called the 'Fourier transform' in order to extract the spectrum from a series of overlapping frequencies. The advantage of this technique is that a full spectral scan can be acquired in about 1 s compared to the 2–3 min required for a dispersive instrument

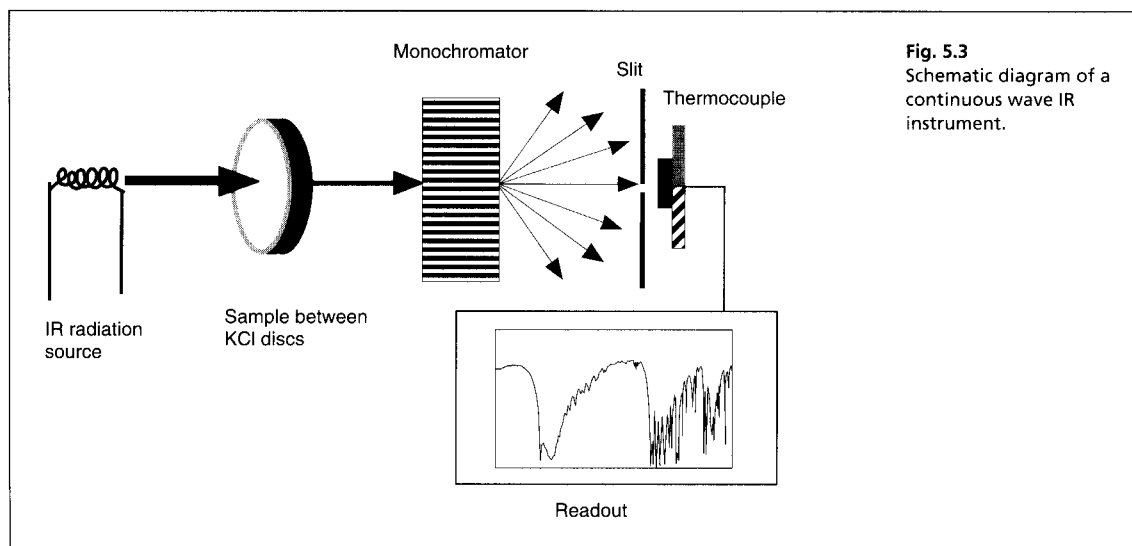

Fig. 5.3
Schematic diagram of a
continuous wave IR
instrument.

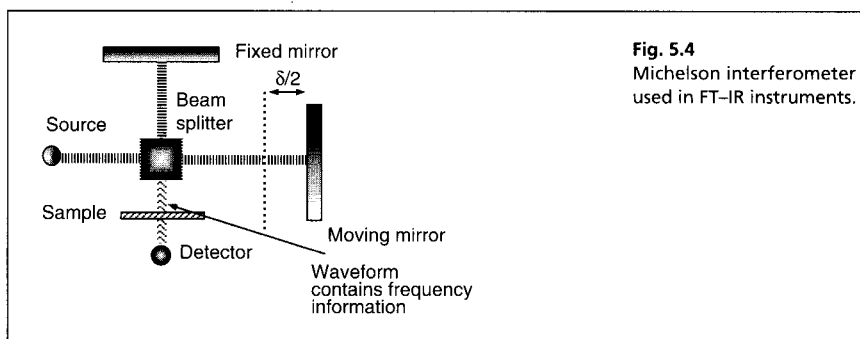

Fig. 5.4
Michelson interferometer
used in FT-IR instruments.

to acquire a spectrum. Also, because the instrument is attached to a computer several spectral scans can be taken and averaged in order to improve the signal:noise ratio for the spectrum.

Instrument calibration

In order to ensure that instruments conform with BP specifications, the wavelength scale of the instrument is checked by obtaining an IR spectrum of polystyrene film (shown in Figure 5.5). Some of the bands used to check the accuracy of the wavelength scale of an IR spectrophotometer are shown in Figure 5.5. The permitted tolerances for variation in the wavelengths of absorption are mainly ± 0.3 nm. Two of the bands at 907 cm^{-1} , 1028 cm^{-1} , 1495 cm^{-1} or 1601 cm^{-1} (usually 1028 and 1601 cm^{-1}) are overlaid onto standard BP spectra to indicate that the spectra have been obtained on a correctly calibrated instrument. In addition to specifying tolerances for the wavelength scale, the BP specifies the degree of resolution which the instrument must be capable of achieving, e.g. the maxima at 2851 cm^{-1} and the minimum at 2870 cm^{-1} should have a valley between them of $> 18\%$ transmittance. In Figure 5.5 the valley between the minimum and maximum at these two wavelengths is *ca* 25% transmittance.

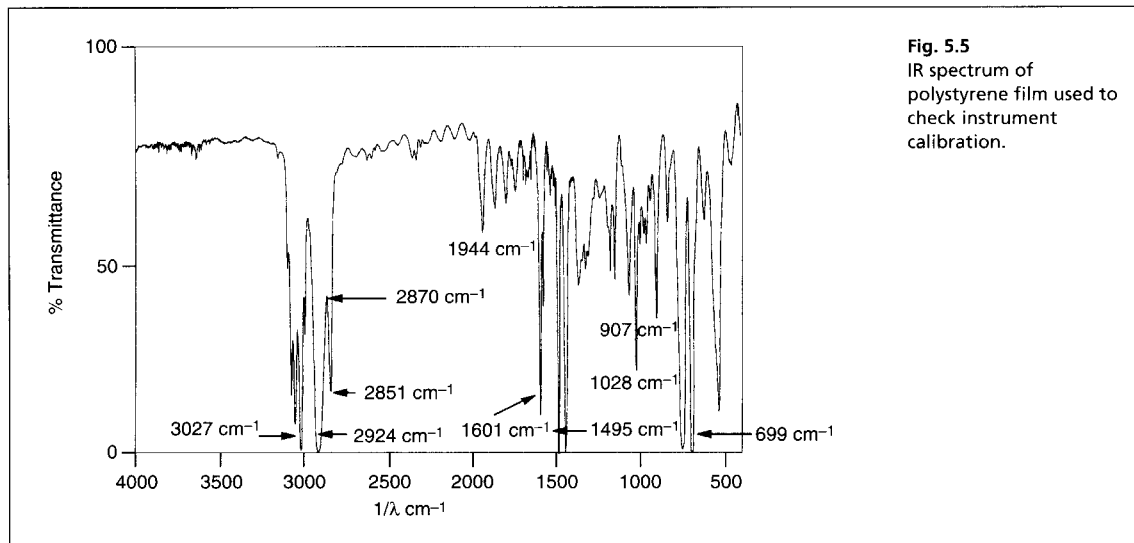
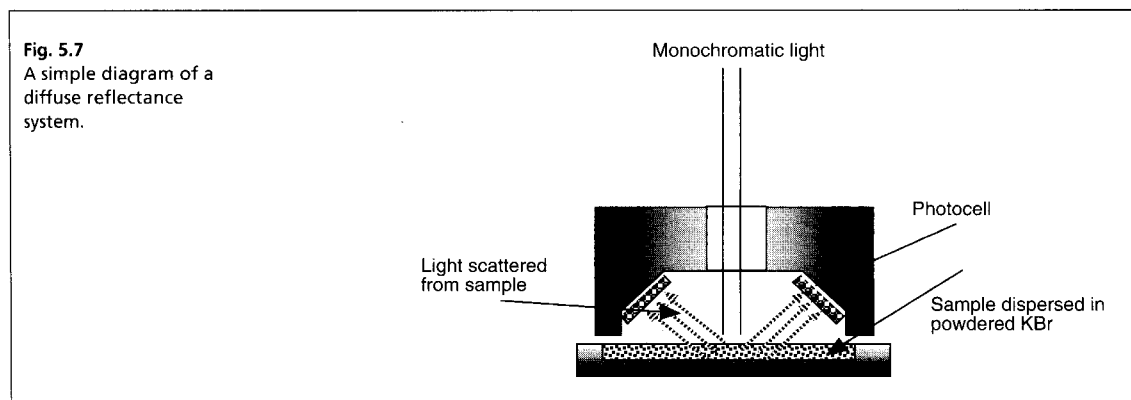
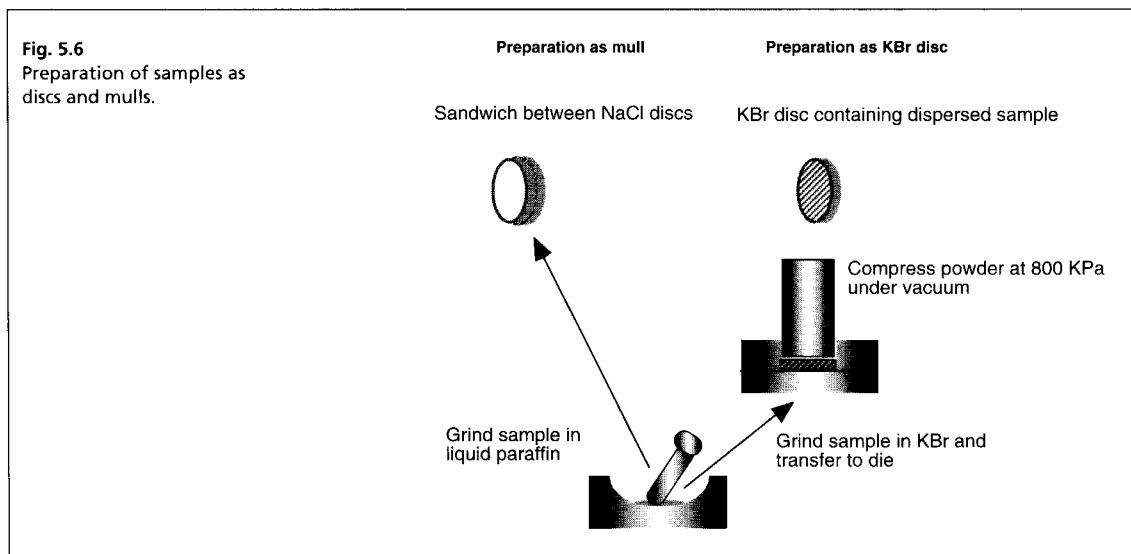

Fig. 5.5
IR spectrum of polystyrene film used to check instrument calibration.

Sample preparation

Traditionally three modes of sample preparation have been used prior to IR analysis:

- (i) The sample is run as a film sandwiched between two NaCl or potassium chloride (KCl) discs. For this method the sample must be a liquid, in which case it can be run without preparation, or must be ground to a paste in a liquid matrix, usually liquid paraffin (Fig. 5.6). In this case the liquid paraffin (nujol) contributes some peaks to the spectrum at *ca* 3000 cm^{-1} and *ca* 1400–1500 cm^{-1} . However, sample preparation is relatively simple and this procedure is used where a chemist just wants a quick identification of certain structural features in a molecule. This procedure is also used to identify different crystal forms (polymorphs) of a drug because the pressures used to prepare KBr discs can cause polymorph interconversion.
- (ii) The sample is ground to a powder with KBr or KCl. KBr is usually used unless a hydrochloride salt is being analysed in which KCl is used to avoid halogen exchange. On a weight-for-weight basis the weight of the sample used is about 1% of the weight of KBr used. About 200 mg of the finely ground powder are transferred to a die block and the sample is then compressed into a disc under vacuum by subjecting it to a pressure of 800 KPa (Fig. 5.6). This is the procedure used in pharmacopoeial methods to prepare a drug for analysis by IR.
- (iii) IR spectra of liquids or solutions in an organic solvent, commonly chloroform, may be obtained by putting the liquid into a short pathlength cell with a width of *ca* 1 mm. Cells are constructed from sodium or potassium chlorides and obviously aqueous samples cannot be used.
- (iv) A more recent development in sample preparation is the use of diffuse reflectance (Fig. 5.7). Diffuse reflectance is a readily observed phenomenon. When light is reflected off a matt surface the light observed is of the same intensity no matter what the angle of observation. Samples for diffuse reflectance are treated in the same way as those prepared for KBr disc formation except that instead of being compressed the fine powder is loaded into a small metal cup, which is placed in the path of the sample beam. The incident radiation is reflected from the base of the cup and during its passage through the powdered sample and back absorption of radiation takes



place—yielding an infrared spectrum which is very similar to that obtained from the KBr disc method. In fact the spectrum produced is an absorbance spectrum rather than a transmittance spectrum but it can be readily converted into a transmittance spectrum if the instrument is attached to a computer. The diffuse reflectance technique is widely used in near-infrared spectrophotometry and it can also be used to examine films and coatings if they are put onto a reflective background. It is also a useful technique for examining polymorphs since the sample can be prepared for analysis with minimal grinding and compression, which can cause interconversion of polymorphs.

- (v) Attenuated total reflectance (ATR) is another recent development in sample handling (Fig. 5.8). In this case the sample may be run in a gel or cream and this method may be used to characterise both formulation matrices and their interactions with the drugs present in them. If the active ingredient is relatively concentrated and if a blank of the matrix is run using the same technique it may be subtracted from the sample to yield a spectrum of the active ingredient. ATR also provides another technique which can be used for the characterisation of polymorphs.

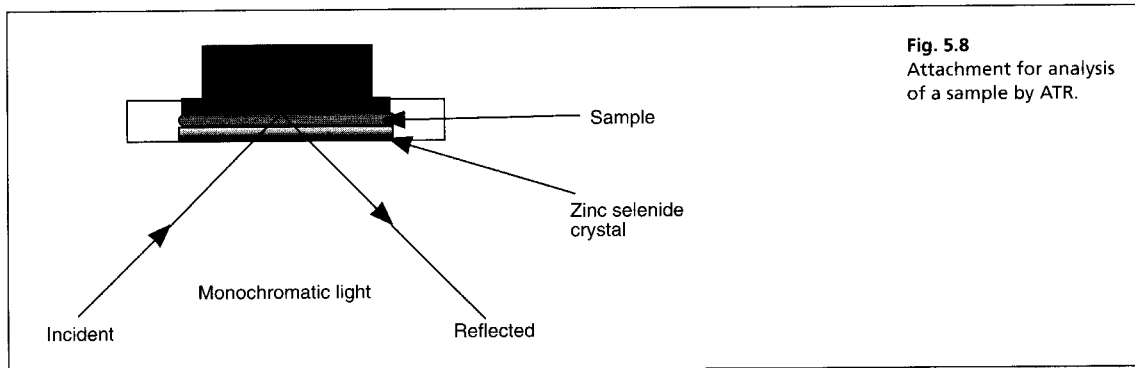

Fig. 5.8
Attachment for analysis
of a sample by ATR.

Self-test 5.2

Suggest methods for analysis of the following samples by IR spectrophotometry:

- (i) Pethidine hydrochloride.
- (ii) Pethidine free base (liquid).
- (iii) A cream containing 2% w/w salicylic acid.
- (iv) A polymorphic form of a drug.
- (v) A plastic to be used in packaging.

Answers: (i) KCl disc or diffuse reflectance infrared Fourier transform (DRIFT) in KCl powder; (ii) Analysed as a liquid film between two NaCl discs; (iii) Analysis by ATR; (iv) Preparation as a nujol mull to avoid interconversion of polymorphs or using DRIFT; (v) A sample of the film is inserted into the IR instrument.

Application of IR spectrophotometry in structure elucidation

As indicated earlier, the extent to which IR spectrophotometry can be used to elucidate structures is limited. The information given in Figure 5.9 is confined to the more easily recognisable bands in the IR spectra of molecules; this is to discourage the notion that IR is a technique used for extensive structure elucidation—in pharmaceutical analysis it is a fingerprint technique. The most readily assigned absorptions are usually at $> 1500\text{ cm}^{-1}$. The bands $< 1500\text{ cm}^{-1}$ are in the fingerprint region of the spectrum where the absorption is very complex and it is difficult to be confident in the assignment of absorptions to particular functional groups. Fuller tables of the bands in the fingerprint region are given elsewhere¹ and the present treatment is focused largely on the bands $> 1500\text{ cm}^{-1}$.

Examples of IR spectra of drug molecules

Some examples of interpretations are given in Figures 5.10–5.14 and Tables 5.3–5.6. In the examples only limited interpretation of the fingerprint region is attempted since often assignments in this region are not certain. Even above 1500 cm^{-1} it is sometimes difficult to assign bands thus IR is not a primary structure elucidation technique.

Fig. 5.9

The major absorptions which can be observed in drug molecules.

stg. = strong absorption; md. = medium absorption; wk. = weak absorption; brd. = broad; shp. = sharp; conj. = conjugated; v.brd. = very broad; A-F additional notes below.

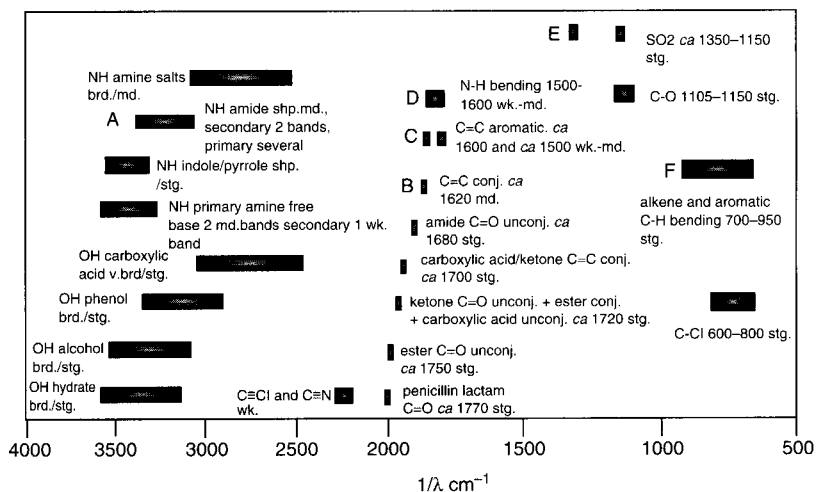

Table 5.2 Additional comments on IR bands in Figure 5.9

Band	Comment
A	Restricted rotation about N–CO bond produces diastereomers giving two bands in the case of secondary amides; see spectrum of phenoxymethylpenicillin (Fig. 5.14)
B	C=C unconjugated gives a very weak absorption but when conjugated the C=C bond gives a much stronger absorption found typically in many steroids
C	C=C aromatic: the band at 1600 cm^{-1} may be weak unless the aromatic ring is substituted with polar substituents, e.g. a phenol, aromatic ether or aromatic amine free base
D	N–H bend is often obscured by stronger aromatic C=C stretching bands
E	SO ₂ bands: although this absorption is in the fingerprint region, these bands are quite prominent in sulphonamides
F	C–H bending in many cases is not very distinctive in drug molecules because of the complexity of the fingerprint region

Fig. 5.10

Infrared spectrum of paracetamol as a KBr disc.

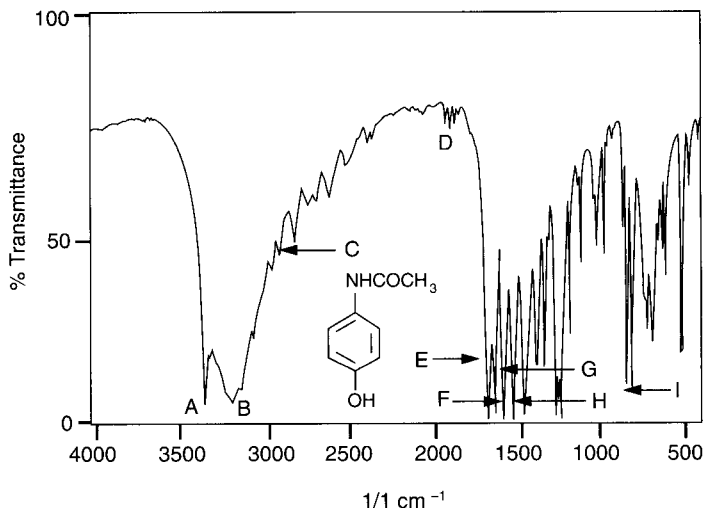

Table 5.3 Interpretation of the IR spectrum of paracetamol

Wavenumber	Assignment	Comments
A 3360 cm^{-1}	N-H amide stretch	This band can be seen quite clearly although it is on top of the broad OH stretch
B 3000 cm^{-1} –3500 cm^{-1}	Phenolic OH stretch	Very broad due to strong hydrogen bonding and thus obscures other bands in this region
C ca 3000 cm^{-1}	C-H stretching	Not clear due to underlying OH absorption
D 1840–1940 cm^{-1}	Aromatic overtone region	Quite clear fingerprint but does not reflect 2 band pattern proposed for <i>p</i> -disubstitution. ²
E 1650 cm^{-1}	C=O amide stretch	C=O stretching in amides occurs at a low wavenumber compared to other unconjugated C=O groups
F 1608 cm^{-1}	Aromatic C=C stretch	This band is strong since the aromatic ring has polar substituents which increase the dipole moment of the C=C bonds in the ring
G 1568 cm^{-1}	N-H amide bending	Strong absorption in this case but this is not always so
H 1510 cm^{-1}	Aromatic C=C stretch	Evidence of a doublet due to interaction with ring substituents
I 810 cm^{-1}	=C-H bending	Possibly aromatic C-H bending but the fingerprint region is too complex to be completely confident of the assignment

**Fig. 5.11**
The infrared spectrum of aspirin as a KBr disc.

Table 5.4 Interpretation of the IR spectrum of aspirin

Wavenumber	Assignment	Comments
A 2400–3300 cm^{-1}	Carboxylic OH stretch	Very broad and complex due to strong hydrogen bonding. The broad band obscures other bands in this region
B ca 3000 cm^{-1}	C–H stretching	Not clear due to underlying OH absorption
C 1757 cm^{-1}	C=O ester stretch	Due to the acetyl group which is an unconjugated aliphatic ester
D 1690 cm^{-1}	C=O conjugated carboxylic acid stretch	C=O of the acid is conjugated to the aromatic ring
E 1608 cm^{-1}	Aromatic C=C stretch	These bands are intense since the ring is substituted with polar groups
F 1460 cm^{-1}	Aromatic C=C stretch	

Fig. 5.12

The infrared spectrum of dexamethasone obtained as a KBr disc. Corticosteroids provide some of the best examples for the assignment of IR bands because of the prominence of the bands in their spectra above 1500 cm^{-1} .

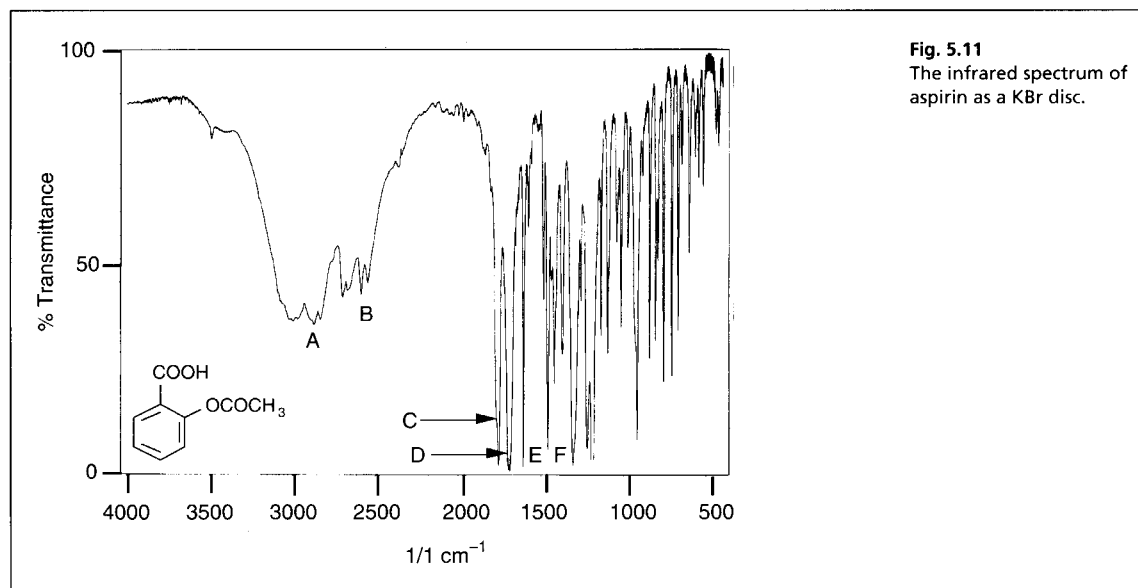
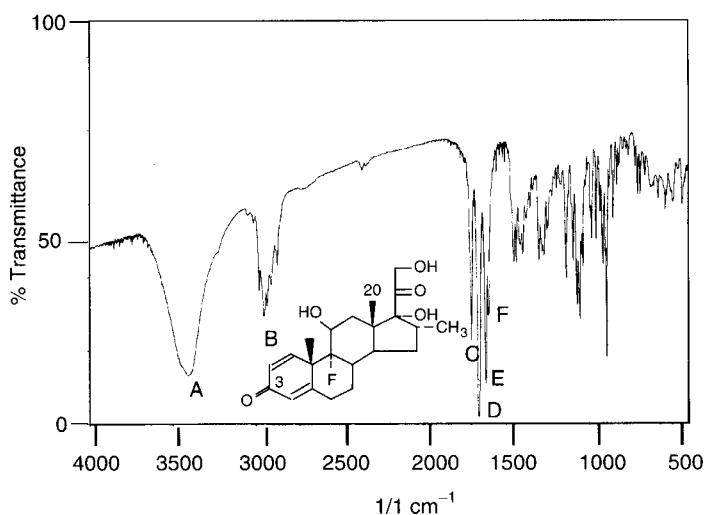
**Table 5.5** Interpretation of the IR spectrum of dexamethasone

Wavenumber	Assignment	Comments
A 3140–3600 cm^{-1}	Alcoholic OH stretch	Broad due to hydrogen bonding
B 2750–3122 cm^{-1}	C–H stretch	Complex region due to the large hydrocarbon skeleton of steroid
C 1705 cm^{-1}	C=O unconjugated ketone stretch	Ketone at 20-position C=O stretch, generally lower than an ester C=O stretch
D 1655 cm^{-1}	C=O conjugated ketone stretch	Ketone at 3-position
E 1615 cm^{-1}	C=C conjugated	Strengthened by being conjugated to a C=O group. Trisubstituted C=C absorbs at a higher wavenumber than disubstituted
F 1600 cm^{-1}	C=C conjugated	Strengthened by being conjugated to a C=O group. Disubstituted C=C absorbs at lower wavenumber than trisubstituted

The spectrum of dexamethasone obtained by the DRIFT technique is shown in Figure 5.13 and is very similar to that obtained using a KBr disc. However, the proportion of dexamethasone powdered with KBr and used to obtain the DRIFT spectrum was 10 times that used to prepare the KBr disc, which yielded the spectrum shown in Figure 5.12. As discussed earlier in this chapter, the use of DRIFT has some advantages over the preparation of a KBr disc.

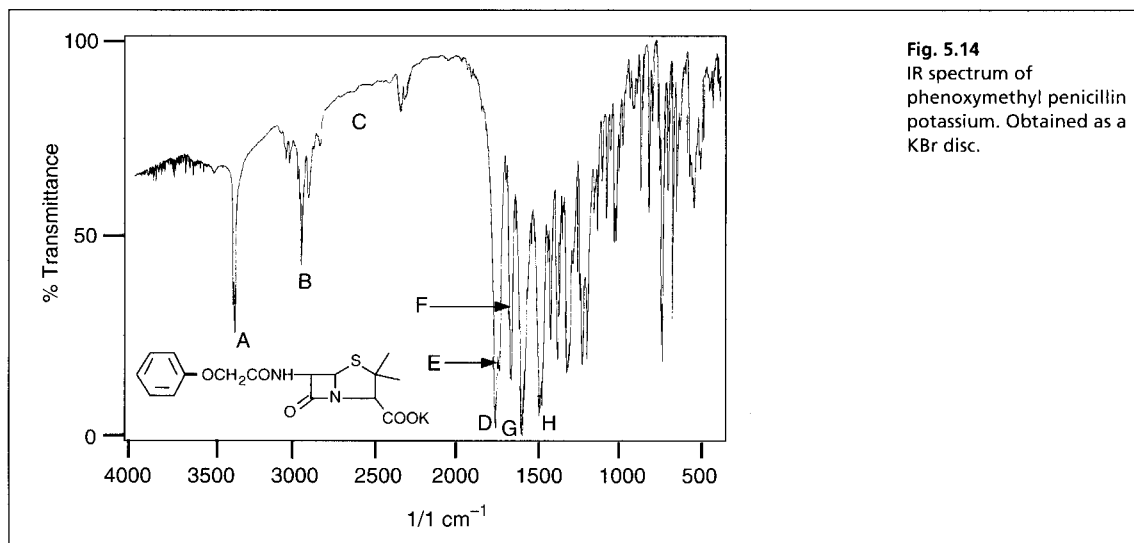
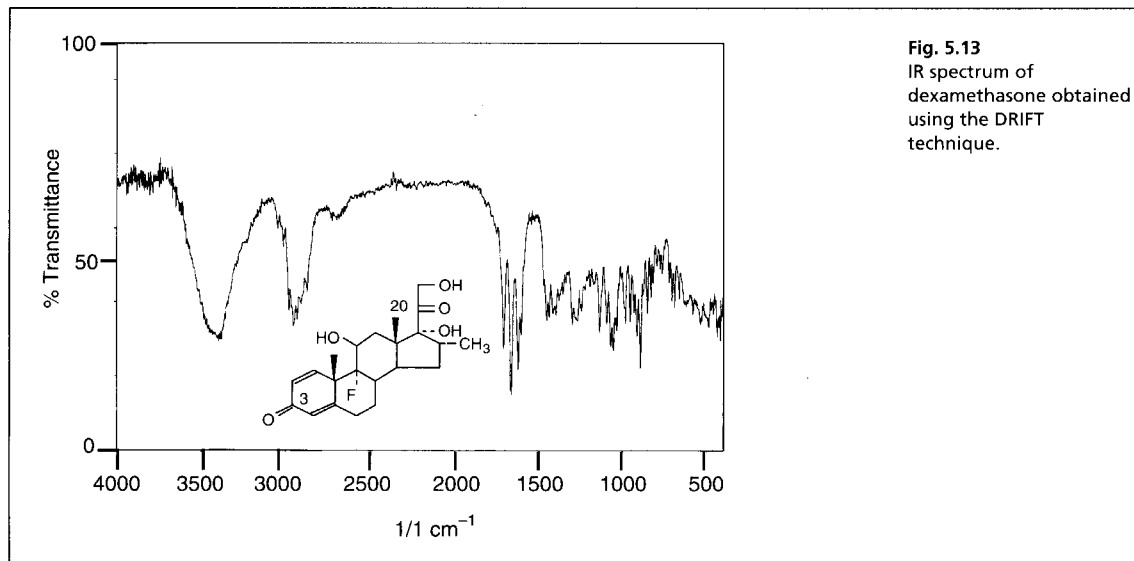
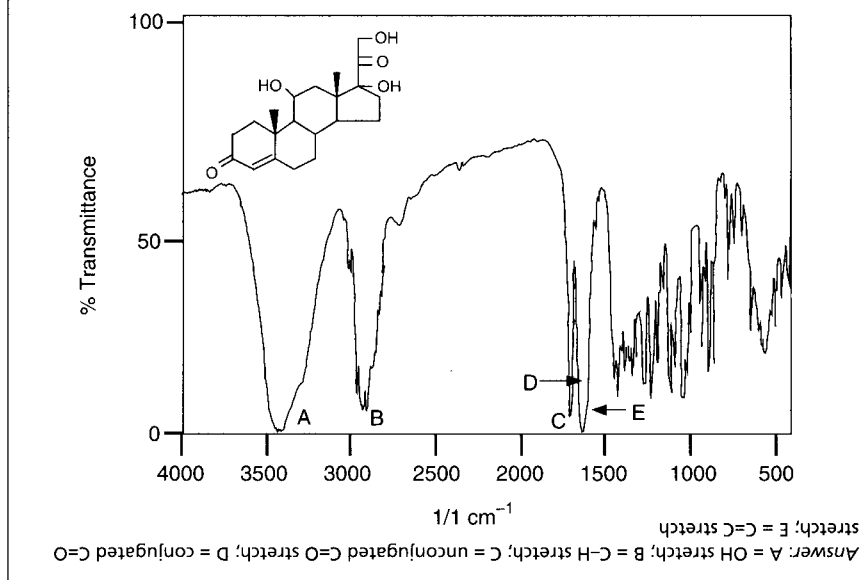

Table 5.6 Interpretation of IR spectrum of phenoxymethyl penicillin potassium

Wavenumber	Assignment	Comments
A 3360 cm^{-1}	N-H amide stretch	Two bands indicating restricted rotation about the N-CO bond resulting in stereoisomers
B 2900–3100 cm^{-1} C 2400–ca 3000 cm^{-1}	C-H stretch	Aliphatic and aromatic C-H stretching OH stretch absent since the carboxylic acid is in the form of its potassium salt
D 1765 cm^{-1}	C=O lactam ring stretch	High energy C=O stretch typical of a lactam ring
E 1744 cm^{-1}	C=O carboxylic acid stretch	Salt thus absence of H bonding means the stretch is of higher energy than in an acid. Compare with esters
F 1690 cm^{-1} G 1610 cm^{-1}	C=O amide stretch C=C stretch	Aromatic ring stretch, broad band possibly obscuring amide N-H bend
H 1505 cm^{-1} and 1495 cm^{-1}	C=C stretch	Aromatic ring

Self-test 5.3

Assign the bands A–E indicated in the spectrum of hydrocortisone.



IR spectrophotometry as a fingerprint technique

Preparation of samples for fingerprint determination

The majority of samples prepared for fingerprint determination in order to determine their degree of conformity with BP standards are prepared as KBr or KCl discs. The instructions with regard to sample preparation stipulate that 1–2 mg of the substance being investigated should be ground with 0.3–0.4 g of KBr or KCl. The KBr or KCl should be free from moisture. The mixture should be compressed at 800 KPa and discs should be discarded if they do not appear uniform. Any disc having a transmittance < 75% at 2000 cm^{-1} in the absence of a specific absorption band should be discarded. The instrument used to measure the IR spectrum should be calibrated using a polystyrene film. Formulations are usually extracted with a specified solvent and it is stipulated that adequate spectra will be obtained only if excipients in the formulation are adequately removed. For pure substances, if difficulty is encountered with obtaining a fingerprint match to the BP spectrum of a reference standard for the substance being examined, the analysis should be repeated where the substance being investigated and the reference standard have been recrystallised from the same solvent. As can be seen in Figure 5.15, even closely related compounds give different IR spectra in the fingerprint region.

Dexamethasone and betamethasone only differ in their stereochemistry at the 16 position on the steroid skeleton. However, this small difference is great enough to result in a different fingerprint spectrum for the two compounds. There are even slight differences in the absorptions of the bands due to C=C stretching at 1620 cm^{-1} .

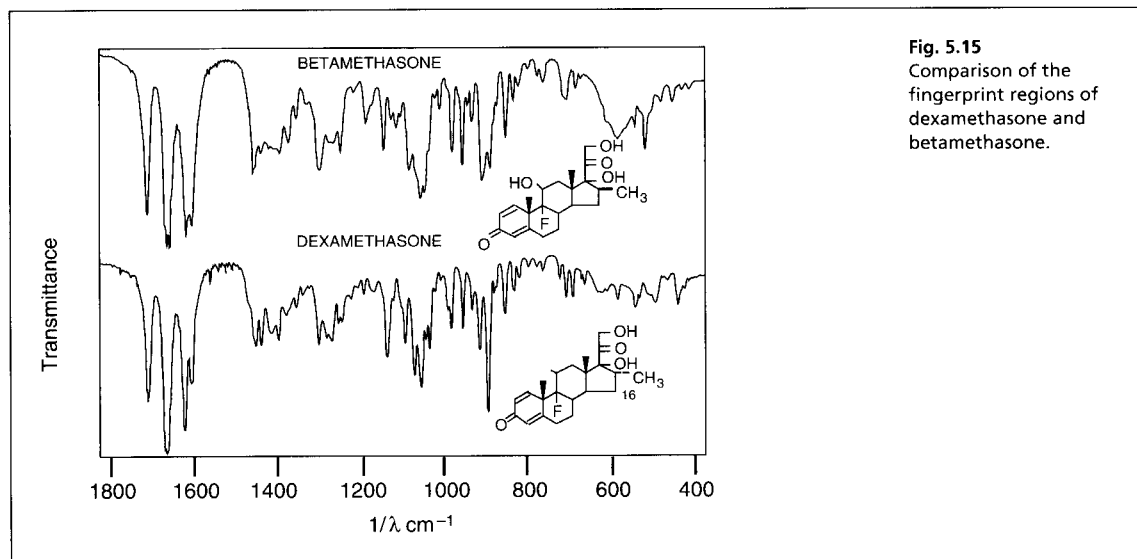
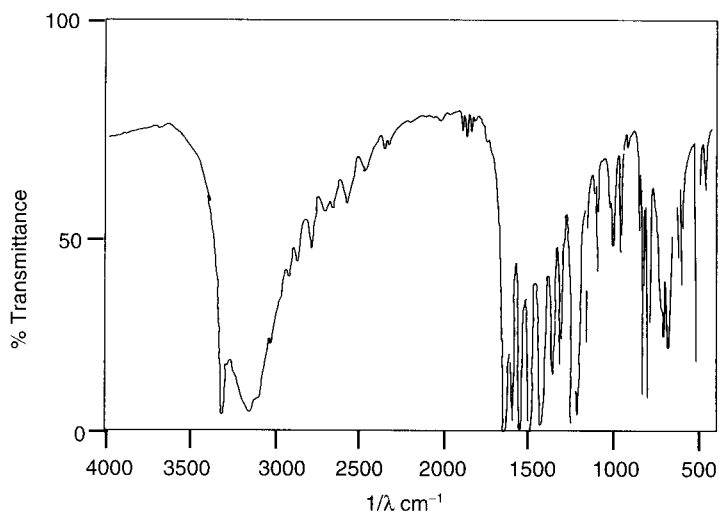
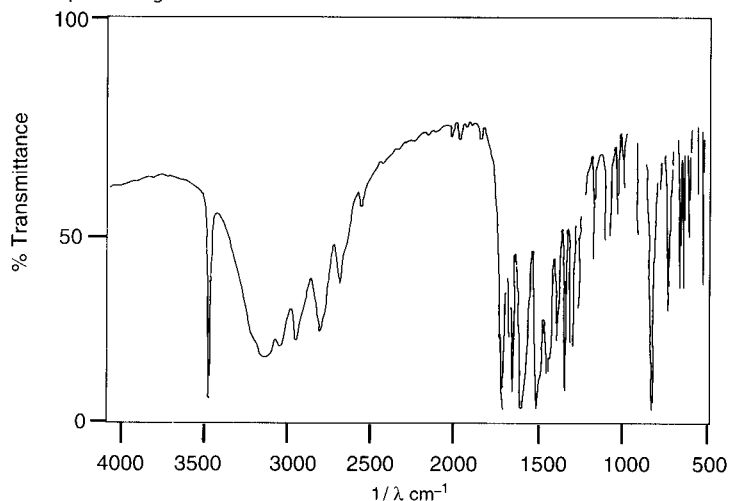

Fig. 5.15 Comparison of the fingerprint regions of dexamethasone and betamethasone.

Self-test 5.4

Compare the fingerprint regions of the following spectra with the spectrum of paracetamol given in Figure 5.10. Which spectrum is due to paracetamol? Suggest what the structure of the unknown compound might be.



Answer: Spectrum B corresponds to paracetamol. Spectrum A is an isomer of paracetamol *o*-hydroxyacetanilide.

Infrared spectrophotometry as a method for identifying polymorphs

IR spectrophotometry along with differential scanning calorimetry and X-ray powder diffraction provides a method for characterising polymorphic forms of drugs. The existence of polymorphs, different crystalline forms of a substance, has an important bearing on drug bioavailability, the chemical processing of the material during manufacture and on patent lifetime. Until recently the standard method of sample preparation for characterising polymorphs by IR was by using a nujol mull to prepare the sample. However, the DRIFT technique has an advantage since it does

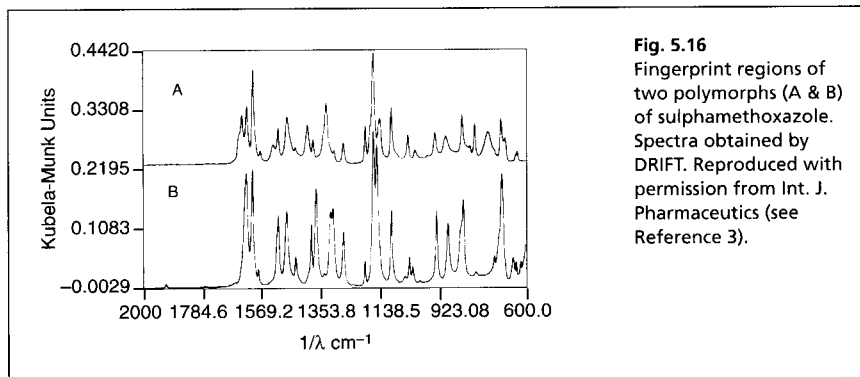

Fig. 5.16
Fingerprint regions of two polymorphs (A & B) of sulphamethoxazole. Spectra obtained by DRIFT. Reproduced with permission from Int. J. Pharmaceutics (see Reference 3).

not introduce the interfering peaks which are present in nujol and which may obscure areas of interest in the fingerprint region of the spectrum. In addition, low polarity samples may be soluble in nujol thus causing their polymorphs to break down. Figure 5.16 shows the spectra of the fingerprint region of two polymorphs of sulphamethoxazole prepared by powdering the samples with KBr and then analysing using DRIFT.³ The units on the Y axis are Kubela Munk units, which are an expression of the data obtained by DRIFT. These can be mathematically converted into transmittance or absorbance if required.

Near-infrared analysis (NIRA)

KEYPOINTS

Principles

- Electromagnetic radiation in between 1000 and 2500 nm is weakly absorbed by the X-H bonds of molecules causing them to stretch. The wavelength of the radiation absorbed is characteristic of the bond absorbing it.

Applications

- Quantitative analysis of multiple components in a sample and in pack quantification of drugs in formulations
- Fingerprint check for the identity of a drug and quality control of complex excipients such as lactose and cellulose used in formulation
- Determination of physico-chemical properties of drugs and excipients such as particle size, water content and polymorphism
- Determination of the physical properties of formulations such as blend uniformity and particle size.

Strengths

- NIR radiation has good penetration properties and thus minimal sample preparation is required and thick sample layers can be used to compensate for the weakness of NIR absorption
- Intense radiation sources can be used since they can be protected by quartz envelopes unlike middle-IR sources
- Has the potential to replace chromatography as a method for more rapid analysis of multicomponent samples.

Limitations

- Extensive method development is required before the technique can be used as a truly rapid analysis technique. Development of a method requires a specialist operator with computing knowledge
- Instruments are expensive compared with middle-IR instruments.

Introduction

The near-infrared region of the spectrum is generally defined as the wavelength range from 700 nm to about 2500 nm. The absorption bands in this region of the spectrum are due to overtones and combinations of fundamental mid-IR vibration bands. Quantum mechanical selection rules forbid transitions over more than one energy level. However, molecules do not behave as ideal oscillators and anharmonic vibration enables overtone bands to occur at two, three, four times, etc. the energy level of the fundamental bands of the mid-IR region. Such overtone bands are *ca* 1000 times weaker than the bands seen in the mid-infrared region. Most of the useful bands in this region are overtones of X–H stretching. The NIRA technique was developed in the 1950s but the paucity of structural information which could be obtained from it caused it to be neglected until the 1980s when applications for it were found in the agricultural and textile industries. The strength of NIRA lies in the quantitative information which it can yield and its ability to identify constituents in multicomponent samples. The applications in quantitative analyses arrived with the ready availability of advanced computing facilities and this is the weakness of the technique, i.e. extensive software development has to take place before the spectral measurements yield useful information. However, it might be anticipated that increasingly sophisticated software will become available. NIRA has the potential to produce great savings in sample preparation and analysis and lends itself very well to process control. The technique is largely used in the DRIFT mode.

Examples of NIRA applications

Extensive use has been made of NIRA in agriculture where it has been used to determine the protein, fibre, water and triglyceride contents of feedstuffs and the quality of crops. By training the computer to recognise the near-infrared (NIR) spectra of the major components making up a crop, the individual components can be monitored in the crop itself. The components that can be measured by NIRA often cannot be measured by the usual spectroscopic methods. The fundamental work done in the quality control of agricultural products can be readily extended to the quality control of pharmaceutical formulations.

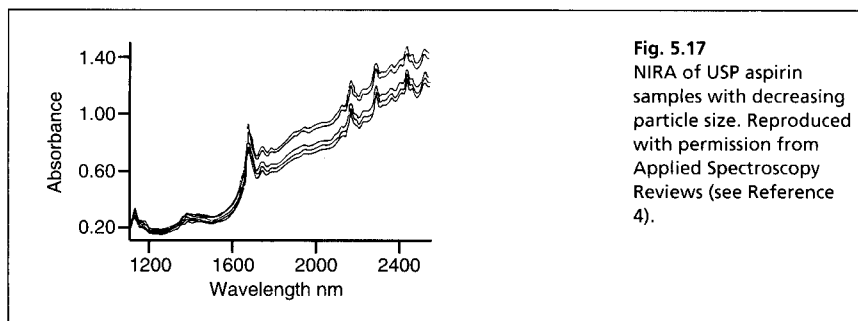

Fig. 5.17
NIRA of USP aspirin samples with decreasing particle size. Reproduced with permission from Applied Spectroscopy Reviews (see Reference 4).

Determination of particle size in United States Pharmacopoeia (USP) grade aspirin

It has been found that there is a linear relationship between NIR absorption and particle size. NIRA can provide a rapid means for determining particle size. Figure 5.17 shows the effect of particle size on the NIR spectra of USP grade aspirin;⁴ the absorbance of the sample increases with decreasing particle size. Particle size is an important factor to be controlled in formulation and manufacture and NIRA provides a rapid means for its determination. In order to validate such a technique it would have to be calibrated against one of the existing methods for particle size determination.

Determination of blend uniformity

NIRA provides an excellent method for the direct monitoring of the uniformity of blends when drugs are being formulated. Figure 5.18 shows the effect of blending time on the uniformity of a sample containing hydrochlorothiazide, lactose, magnesium stearate and croscarmellose sodium.⁵ The most notable variations in absorbance intensity in the spectrum of the blend occur at 2030 nm and 2240 nm. Absorbance at these wavelengths can be attributed to hydrochlorothiazide and lactose, respectively. The more complete the blend, the less the standard deviations of the absorbances at these wavelengths obtained when several batches sampled at the same time point are compared. As would be expected the standard deviations shown in Figure 5.17 decreases with blend time but the decrease is less marked after 10 min. In this study it was found that blending for more than 20 min caused a loss in uniformity due to an alteration in the flow properties of the powder resulting from a change in the distribution of the magnesium stearate. NIR probes can be inserted directly into blenders to monitor mixing.

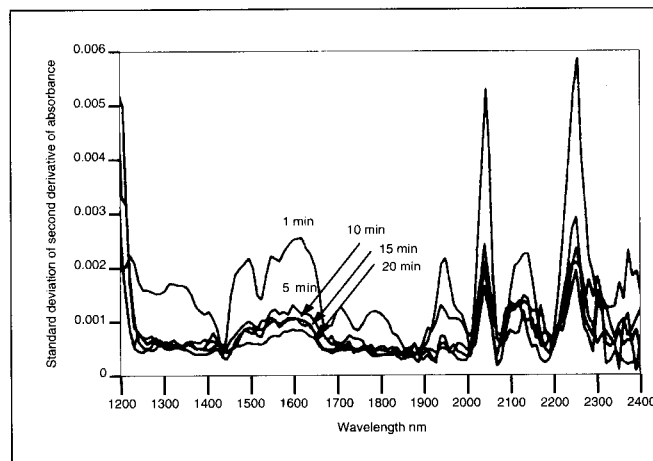

Fig. 5.18
The effect on differences in blend time on the uniformity of a formulation containing lactose and hydrochlorothiazide. Reproduced with permission from J. Pharm. Biomed. Anal. (see Reference 5).

Determination of active ingredients in multicomponent dosage forms

NIRA has been used to analyse multicomponent tablets, e.g. aspirin/caffeine/butalbarbital, and can examine such tablets in a pass/fail manner.⁶ The tablets fail

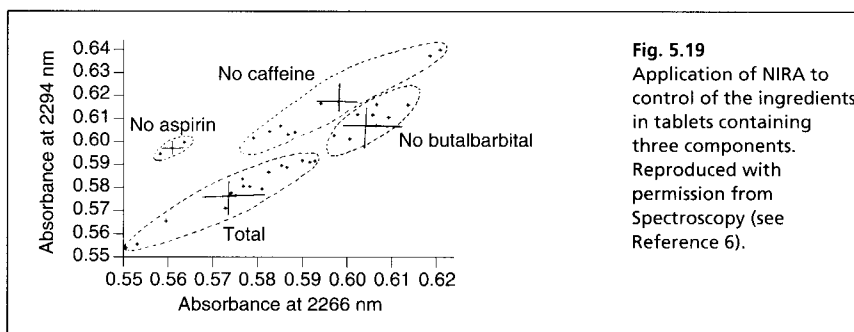
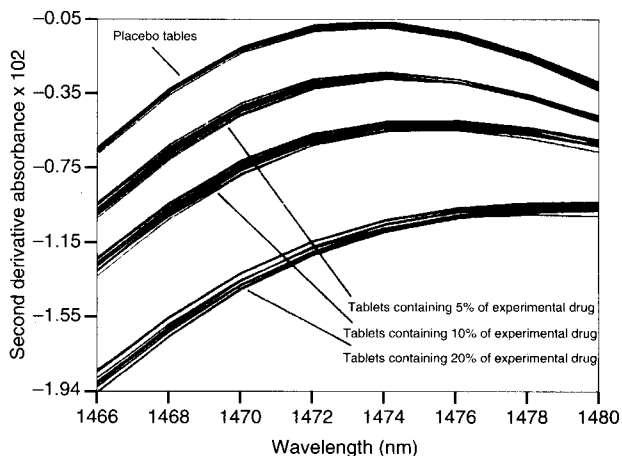

Fig. 5.19
Application of NIRA to control the ingredients in tablets containing three components. Reproduced with permission from Spectroscopy (see Reference 6).

Fig. 5.20
Determination of the amount of active ingredient in tablets by direct use of NIRA. Reproduced with permission from J. Pharm. Biomed. Anal. (see Reference 7).



when the ingredients fall outside the specified range as shown in Figure 5.19, which is derived by the monitoring of two wavelengths in the NIR spectrum of the formulation. This might appear simple but a great deal of development work was carried out in order to determine which wavelengths to monitor in order to give the best discrimination.

In-pack determination of active ingredients

In clinical trials of a new drug it is important to ensure that the tablets have been packed and coded correctly. Figure 5.20 shows the absorbance of tablets monitored at a wavelength which can be correlated with the content of active ingredient.⁷ It was possible to distinguish between tablets containing 0, 5, 10, 15 and 20% of the active ingredient. It was also possible to adapt the method to determination of the active ingredient of the tablets 'in pack' using a fibreoptic probe, although the precision was not quite as good as that obtained from the unpackaged tablets.

Determination of polymorphs

NIRA provides a non-destructive alternative to differential scanning calorimetry for the determination of polymorphic forms of drugs, e.g. the polymorphic forms of caffeine.⁴ NIRA has also been used to determine optical purity. While the pure opposite enantiomers of a substance have identical NIR spectra, mixing two

enantiomers together causes a change in the spectrum. Thus there is potential for determining the percentage of each enantiomer in an enantiomeric mixture and hence for the control of enantiomeric impurities.⁴

Moisture determination

Use can be made of a strong absorption band for water at 1940 nm in the NIR region in order to quantify the water in pharmaceuticals; good agreement has been found with Karl Fischer determinations. Recently a study was carried out in order to determine water content in freeze-dried sterile product in glass ampoules.⁸ The method developed was only partially successful due to variations in the hydrogen bonding of water with the product but it should be possible to optimise the wavelengths used for monitoring such bound water.



Additional problems

1. Four steroids (i), (ii), (iii) and (iv) correspond to the structures below (Fig. 5.21). The steroids are analysed by IR as KBr discs. The principal bands in their spectra between 1500 cm^{-1} and 4000 cm^{-1} are given below. Determine which of the structures given below correspond to (i), (ii), (iii) and (iv).

- (i) Steroid ca 3000 cm^{-1} , 1710 cm^{-1} , 1670 cm^{-1} , 1620 cm^{-1} .
- (ii) Steroid 3460 cm^{-1} (broad band), ca 3000 cm^{-1} , 1710 cm^{-1} , 1660 cm^{-1} , 1620 cm^{-1} , 1610 cm^{-1} .
- (iii) Steroid 2900–3500 cm^{-1} (very broad band obscuring other bands in this region), 1605 cm^{-1} , 1580 cm^{-1} , 1500 cm^{-1} .
- (iv) Steroid 3400 cm^{-1} (broad band), ca 3000 cm^{-1} , 1670 cm^{-1} , 1605 cm^{-1} .

Fig. 5.21

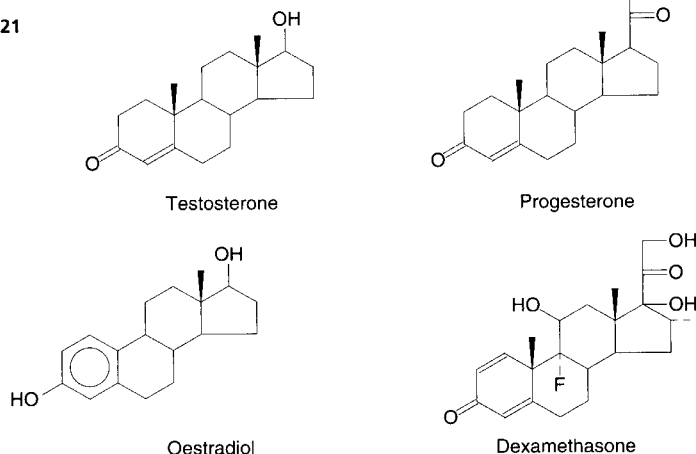

Answer: (i) progesterone; (ii) dexamethasone; (iii) oestradiol; (iv) testosterone

2. The principal bands between 1500 cm^{-1} and 4000 cm^{-1} are given for the molecules shown below (Fig. 5.22). Associate each set of data with one of the molecules.

- (i) ca 3000 cm^{-1} , 2300–2900 cm^{-1} (very broad), 1600 cm^{-1} (weak), 1500 cm^{-1} .
- (ii) 3300–3500 cm^{-1} (broad), ca 3000 cm^{-1} , 1750 cm^{-1} , 1720 cm^{-1} , 1650 cm^{-1} , 1612 cm^{-1} , 1600 cm^{-1} .
- (iii) 3370 cm^{-1} (sharp), 2300–3200 cm^{-1} (broad band obscuring other bands in this region), 1780 cm^{-1} (with slight shoulder at 1750 cm^{-1}), 1690 cm^{-1} , 1605 cm^{-1} , 1580 cm^{-1} , 1500 cm^{-1} .
- (iv) 3380 cm^{-1} , 3320 cm^{-1} , ca 3000 cm^{-1} , 2300–2900 cm^{-1} (very broad), 1690 cm^{-1} , 1620 cm^{-1} , 1600 cm^{-1} , 1500 cm^{-1} .

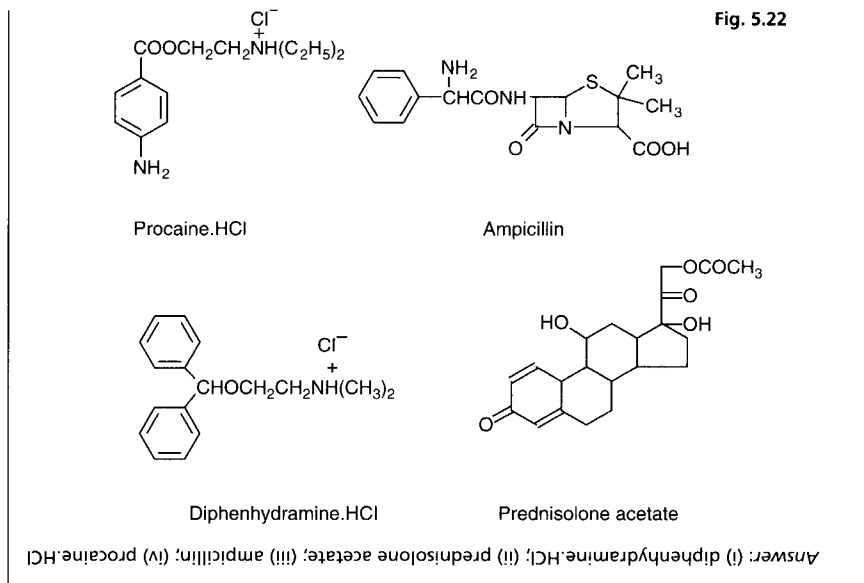

Process control of components in a shampoo

NIRA was studied as a technique for process control in the manufacture of shampoo.⁹ The formulation contained detergent, solids, water and glycerol. In order to carry out the process control samples of shampoo were taken at various points in the production process. NIR reflectance spectra were obtained for 75 samples over the range 1100–2500 nm. A multiple step-up linear regression analysis was performed at nine wavelengths. This type of statistical test consists in multiple correlations of absorbances at different wavelengths with the concentration of the ingredients of the shampoo determined by classical methods. Correlation coefficients of 0.99 were obtained for water, solids and detergent with a rather lower correlation for glycerol, which at 1% in the matrix was close to the limits of detection. The technique was deemed suitable for flow through monitoring. The computer monitoring of the the process by NIRA could be used to control actuators and valves within the chemical processing plant.

References

1. D.H. Williams and I. Fleming. *Spectroscopic methods in organic chemistry*. 4th Edn. McGraw-Hill, London (1989).
2. R.E. Schrimmer. *Modern methods of pharmaceutical analysis*. Vol 1. CRC Press, Boca Raton (1991).
3. K.J. Hartauer, E.S. Miller and J.K. Guillory. *Int. J. Pharmaceutics*. 85, 163–174 (1992).
4. E.W. Ciurczak. *Applied Spectroscopy Reviews*. 23, 147–163 (1987).
5. D.J. Wargo and J.K. Drennen. *J. Pharm. Biomed. Anal.* 14, 1415–1423 (1996).
6. E.W. Ciurczak and T. Maldacker. *Spectroscopy* 1, 36–39 (1986).
7. M.A. Dempster, J.A. Jones, I.R. Last, B.F. MacDonald and K.A. Prebble. *J. Pharm. Biomed. Anal.* 11/12, 1087–1092 (1993).
8. I.R. Last and K.A. Prebble. *J. Pharm. Biomed. Anal.* 11/12, 1071–1076 (1993).
9. P.L. Walling and J.M. Dabney. *J. Soc. Cosmet. Chem.* 39, 191–199 (1988).

Additional reading

Infrared Characteristic Group Frequencies: Tables and Charts. G. Socrates 2nd Edn. Wiley Interscience (1994).

Fourier Transform Infrared Spectrometry. P. Griffiths and J.A. De Haseth. Wiley Interscience (1986).

Making Light Work: Advances in Near Infrared Spectroscopy. I. Murray and I.A. Cowe. Wiley Interscience (1992).

6

Atomic spectrophotometry

Atomic emission spectrophotometry

Keypoints

Introduction

Instrumentation

Examples of quantitation by AES

Assay of sodium and potassium ions in an i.v. infusion

Interferences in AES analysis

Ionisation

Viscosity

Anionic interference

Assays based on method of standard additions

Assay for KCl, NaCl and glucose i.v. infusion

Atomic absorption spectrophotometry

Keypoints

Introduction

Instrumentation

Examples of assays using AAS

Assay of magnesium and calcium in haemodialysis fluid

Some examples of limit tests employing AAS

Assay of lead in sugars

Trace metals in a silicone foam cavity wound dressing

Applications of AAS in BP assays

Inductively coupled plasma emission spectroscopy

Atomic emission spectrophotometry (AES)

KEYPOINTS

Principles

Atoms are thermally excited so that they emit light and the radiation emitted is measured.

Applications in pharmaceutical analysis

- Quantification of alkali metals in: alkali metal salts, infusion and dialysis solutions.
- Determination of metallic impurities in some of the other inorganic salts used in preparing these solutions.

Strengths

- Flame photometry provides a robust, cheap and selective method based on relatively simple instrumentation for quantitative analysis of some metals.

Limitations

- Only applicable to the determination of alkali and some alkaline earth metals.

Introduction

Atomic emission spectroscopy plays an important role in the control of sodium, potassium and lithium in a number of raw materials and formulations.

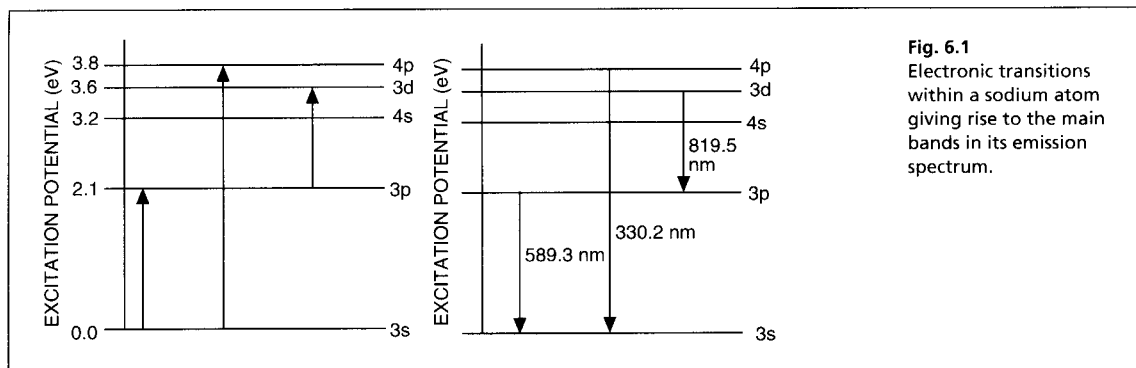

Fig. 6.1
Electronic transitions within a sodium atom giving rise to the main bands in its emission spectrum.

Atoms contain various energy states as illustrated in Figure 6.1 for the sodium atom. The normal unexcited state is the ground state. Sodium contains 1 electron in its outer ($3p$) orbital and if energy is gained by the atom this electron may be excited to a higher state and then subsequently lose its excess energy by falling back to a lower energy orbital. Thus when a sodium salt is heated in a flame the outer electrons in the volatilised atoms are excited and then return to the ground state with emission of energy, which appears for example as yellow light (wavelength 589.3 nm). The major line in the sodium emission spectrum is due to an electron falling from the $3p$ excited state to the $3s$ ground state; the atomic emission spectrum of sodium contains two other major lines at 819.5 nm and 330.2 nm due to the transitions shown in Figure 6.1. Atomic emission lines are very narrow (< 0.01 nm). Only a limited number of elements are sufficiently excited by thermal energy for AES measurements to be carried out. Common elements with emission lines suitable for utilisation in their quantitation are Ca, Ba, Na, Li and K.

Instrumentation

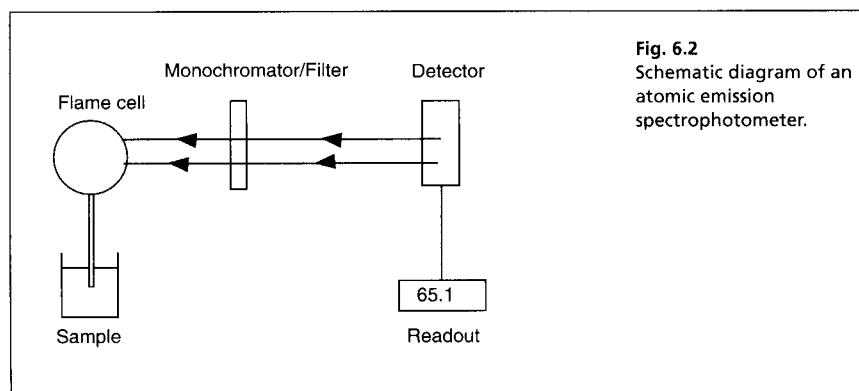

Fig. 6.2
Schematic diagram of an atomic emission spectrophotometer.

An atomic emission spectrophotometer (Fig. 6.2) is composed of the following components:

- (i) **Flame.** The sample containing the metal is volatilised in a natural gas flame at 2000°C . A higher temperature (2500°C) may be obtained using air/acetylene and is required for analysis of Mg by AES.

- (ii) **Monochromator/Filter.** The radiation emitted by the excited atoms is passed through a filter or a monochromator in more expensive instruments. Thus a narrow band of emitted radiation is selected and interfering sources of radiation such as the flame and other components in the sample are screened out.
- (iii) **Detector.** The intensity of the selected radiation is then measured using a photosensitive cell.

Examples of quantitation by AES

In order to measure a sample by AES a calibration curve is constructed by aspirating solutions of known concentration into the flame.

Assay of sodium and potassium ions in an i.v. infusion

Standard solutions of sodium chloride (NaCl) and potassium chloride (KCl) in water were prepared and diluted appropriately to give a calibration curve across the working range across the range of the instrument (*ca* 0.05–1 mg/100 ml). The assay was then carried out by diluting the infusion until its concentration was close to that at the mid-point of the calibration series. Water is used as a blank. The following results were obtained:

- (i)
- Weight of NaCl used to prepare standard solution = 0.5092 g
 - Weight of KCl used to prepare standard solution = 0.1691 g
- Both standards were transferred to the same 1000 ml volumetric flask and diluted to 1000 ml.
- (ii) Dilutions were carried out on standards:
- *Step 1:* 20 ml of the standard solution was transferred to a 100 ml volumetric flask and was diluted to 100 ml (diluted standard solution)
 - *Step 2:* A calibration series was prepared by transferring the following volumes of diluted standard solutions to 100 ml volumetric flasks 0, 5, 10, 15 and 25 ml.
- (iii) The infusion solution was diluted as follows:
- *Step 1:* 5 ml to 250 ml
 - *Step 2:* 10 ml to 100 ml.
- (iv) The instrument was used with a sodium filter to establish the sodium calibration curve and then the sodium in the sample. The instrument was switched to a potassium filter in order to determine the potassium calibration curve and the potassium in the sample. Table 6.1 shows the readings obtained for sodium (Na) and potassium (K) in the calibration solutions as well as the concentrations of Na and K in the calibration solutions (calculated below). Calculate the concentrations of Na and K in the infusion solution in mmoles/l. Atomic weights: Na = 23; K = 39.1; Cl = 35.5.

Table 6.1 Data used in Calculation example 6.1

Amount of Na mg/100 ml	Flame photometry reading	Amount of K mg/100 ml	Flame photometry reading
0	0	0	0
0.2002	20.7	0.08923	22.4
0.4004	41.0	0.1785	41.2
0.6006	60.6	0.2677	61.2
0.8008	80.3	0.3569	80.3
1.010	100	0.4462	100

Calculation example 6.1

0.5092 g of NaCl/l is equivalent to $0.5092 \times \frac{23}{58.5} = 0.2002$ g of Na/l = 200.2 mg/l.
= 20.02 mg/100 ml.

0.1691 g of KCl is equivalent to $0.1691 \times \frac{39.1}{74.1} = 0.08923$ g of K/l = 89.23 mg/l.
= 8.923 mg/100 ml.

Dilutions of standards

Step 1: 20 to 100 ml ($\times 5$).

Step 2: Point 1 = 5 to 100 ($\times 20$).

Total dilution = $5 \times 20 = 100$.

Concentrations in solution used for point 1.

$$\text{Na} = \frac{20.02}{100} = 0.2002 \text{ mg/100 ml} \quad \text{K} = \frac{8.923}{100} = 0.08923 \text{ mg/100 ml.}$$

The rest of the points in the calibration series are simply $\times 2$, $\times 3$, $\times 4$ and $\times 5$. These values give the concentrations in Table 6.1.

The equations of the lines obtained for the above data were:

For Na $y = 99.0 \times +0.722$.

For K $y = 222 \times +1.3$.

Reading of diluted sample for Na = 70.2 Reading of diluted sample for K = 70.6.

Dilution of sample

Step 1: 5 to 250 ml ($\times 50$).

Step 2: 10 ml to 100 ml ($\times 10$) Total dilution $50 \times 10 = 500$.

Concentration of Na in infusion

Substituting into the equation of the line for Na.

$$\text{Concentration of Na in diluted sample} = \frac{70.2 - 0.772}{99.0} = 0.701 \text{ mg/100 ml.}$$

Dilution factor = $\times 500$.

Concentration of Na in infusion = $0.701 \times 500 = 351 \text{ mg/100 ml} = 3510 \text{ mg/l.}$

$$= \frac{3510}{23} = 153 \text{ mmoles/l.}$$

Self-test 6.1

From the data given in Calculation example 6.1, calculate the concentration of K in the infusion.

Answer: 39.9 mmoles/l

Self-test 6.2

From the following data calculate the potassium content per tablet in effervescent KCl bicarbonate tablets.

- Weight of 20 tablets = 35.6751 g
- Weight of tablet powder taken for assay = 0.1338 g

The sample is dissolved in 500 ml of water and then 5 ml of the sample solution are taken and diluted to 100 ml.

- Weight of KCl used to prepare standard = 0.1912 g

The standard was dissolved in 100 ml of water and 5 ml of the standard solution were diluted to 250 ml.

The diluted standard solution was used to prepare a calibration series by transferring 0, 5, 10, 15, 20 and 25 ml to 100 ml volumetric flasks and making up to volume.

The following readings were obtained for the calibration series: 0, 20.3, 40.1, 60.3, 80.1 and 100.

- Reading obtained for potassium in the diluted sample solution = 73.9.

Answer: (From a computer fitted calibration curve) 496.2 mg per tablet

Interferences in AES analysis

Ionisation

At high flame temperatures, atoms such as K may completely lose an electron thus reducing the observed emission from the sample:

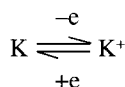

Ionisation is an equilibrium and may be shifted to the left by addition of another readily ionised element to the sample which produces electrons. The emission lines from the added metal are unlikely to interfere because AE lines are very narrow, and thus there will be no overlap, e.g. strontium chloride solution is added in order to suppress the ionisation of K in the BP assay of effervescent KCl tablets.

Viscosity

Organic substances in a sample can either increase or decrease the rate at which it is drawn into the flame relative to a standard solution by increasing or decreasing the viscosity, e.g. sucrose decreases the rate thus giving a false low reading while ethanol increases the rate thus giving a false high reading.

Anionic interference

Anions such as sulphate and phosphate form involatile salts with metal ions and reduce the reading of the sample solution. These anions may be removed by the addition of lanthanum chloride which precipitates them out and replaces them with the chloride anion.

Assays based on method of standard additions

The method of standard additions can be used with many analytical techniques where interference from the matrix has to be eliminated and is of general use in residue or trace analysis. Essentially the technique involves addition of increasing volumes of a standard solution to a fixed volume of the sample to form a calibration series. An advantage of the technique is that since several aliquots of sample are analysed in order to produce the calibration series the method gives a measure of the

precision of the assay. For example five identical aliquots of sample solution are mixed with increasing volumes of a standard solution. If x is the amount of metal ion in the sample solution the amounts of metal ion added should be *ca* 0, 0.5 x , 1.5 x , 2.0 x and 2.5 x . The calibration curve obtained will look something like that shown in Figure 6.3. The concentration of the metal in the sample is given by the distance between the origin and where the graph intersects the x axis, i.e. the point where $Y = 0$ in the equation of the line.

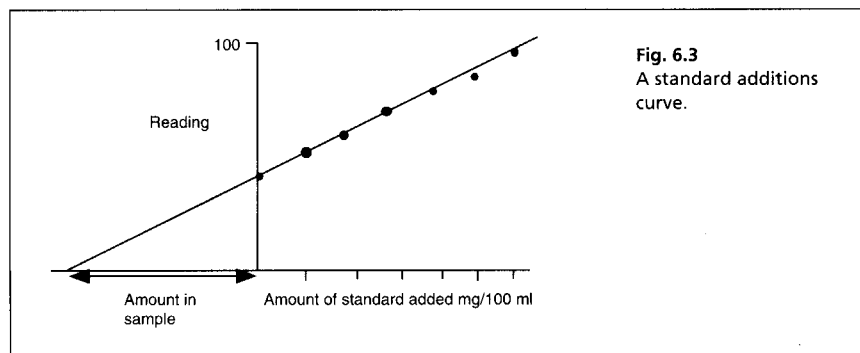

Assay for KCl, NaCl and glucose i.v. infusion

Analysis of the infusion was carried out using the method of standard additions, and the below data was obtained. From the tabulated data given below plot a curve and determine percentage of w/v of NaCl and KCl in the infusion.

- (i) The following standard stock solutions were prepared in order to calibrate the instrument for sodium and potassium:
 - NaCl (0.2351 g) was dissolved in de-ionised water and the solution was made up to 1000 ml.
 - KCl (0.3114 g) was dissolved in de-ionised water and the solution was made up to 1000 ml.
- (ii) An aliquot (20 ml) of each stock solution was transferred to the same 100 ml volumetric flask and the volume was adjusted to 100 ml with de-ionised water (diluted stock solution).
- (iii) The sample of i.v. infusion was diluted by transferring 5 ml to a 100 ml volumetric flask and making up to volume with de-ionised water.
- (iv) A calibration curve was prepared by transferring, in each case, 5 ml of diluted sample solution plus varying amounts of diluted stock solution to a 100 ml volumetric flask as indicated in Table 6.2 and then making up to 100 ml with de-ionised water.

Table 6.2 Results obtained from additions of Na and K

Volume of sample solution added	Volume of diluted stock solution added	Final volume	Reading of Na	Reading for K
5	0	100	26.1	30.1
5	5	100	39.3	45.2
5	10	100	54.2	58.8
5	15	100	69.2	73.1
5	20	100	84.1	87.0
5	25	100	100	100

Calculation example 6.2**Dilutions of standards**

Initial concentration of NaCl = 0.2531 g/l = 253.1 mg/l = 25.31 mg/100 ml.

Dilution 1: 20 to 100 ml ($\times 5$).

Dilution 2: Point 1 on calibration curve = 5 to 100 ml ($\times 20$).

Total dilution = $5 \times 20 = 100$.

Concentrations in solution used for point 1.

$$\text{NaCl} = \frac{25.31}{100} = 0.2531 \text{ mg/100 ml.}$$

The rest of the points are simply $\times 2$, $\times 3$, $\times 4$ and $\times 5$, this value giving the following concentrations of added NaCl in the calibration series: 0.2531, 0.5062, 0.7593, 1.012 and 1.266 mg/100 ml.

The data were used to plot a calibration curve for NaCl.

Equation of line obtained for NaCl: $y = 58.57x + 25.09$.

When $y = 0$ the negative x value = concentration of NaCl in the diluted sample.

$$\text{Concentration of NaCl in diluted sample} = \frac{25.09}{58.57} = 0.4284 \text{ mg/100 ml.}$$

Dilutions of sample were 5 to 100 ml ($\times 20$) then 5 to 100 ml ($\times 20$) = $\times 400$.

Concentration of NaCl in sample = $171.4 \text{ mg/100 ml} = 0.1714 \text{ g/100 ml} = 0.1714\% \text{ w/v.}$

Self-test 6.3

From the data given above calculate the percentage of w/v of KCl in the sample.

Answer: From computer fitting of calibration curve KCl = 0.2742% w/v

AES is used in pharmacopoeial assays of: (1) Na in albumin solution and plasma protein solution; (2) K, Na and barium (Ba) in calcium acetate used to prepare dialysis solutions; (3) Ca in adsorbed vaccines (e.g. diphtheria and tetanus). It is also used to determine sodium and potassium concentrations in urine.

Atomic absorption spectrophotometry (AAS)**KEYPOINTS****Principles**

Atoms of a metal are volatilised in a flame and their absorption of a narrow band of radiation produced by a hollow cathode lamp, coated with the particular metal being determined, is measured.

Applications in pharmaceutical analysis

- Determination of metal residues in drugs remaining from the manufacturing process.

Strengths

- More sensitive than AES. A highly specific method of analysis useful in some aspects of quality control.

Limitations

- Only applicable to metallic elements.
- Each element requires a different hollow cathode lamp for its determination.

Introduction

For many atoms the energy difference between their ground state orbital and the excited state is too great for thermal excitation of a significant number of electrons to take place. Where energy differences are too great to get an emission reading, AAS may be used. Metal atoms are volatilised in a flame and radiation is passed through the flame. In this case the volatilised atoms, which are mainly in their ground state and thus not emitting energy, will absorb radiation with an energy corresponding to the difference between their ground state and the excited state (Fig. 6.4). The number of atoms in the ground state which are available for excitation is much greater than the small fraction that become excited and emit energy in AES. Thus AAS is a much more sensitive technique than AES. Since the width of absorption or emission lines in atomic spectra is extremely narrow, the only source of light where significant absorption can be observed, after it passes through the sample, is where the light is produced by excitation of the atoms of the element being analysed. The lamp used is called a 'hollow cathode lamp' and the cathode is coated with the metal which is to be analysed. For example in the analysis of zinc (Zn), a Zn-coated cathode is used and the excitation of the Zn atoms produces a narrow band of radiation at 214 nm, which can be efficiently absorbed by the atoms in the flame. The disadvantage of this is that the lamp has to be changed every time a different element is being analysed and only one element can be analysed at a time. Modern instruments have about 12 lamps mounted on a carousel, which may be automatically rotated into line with the flame and improve the speed of multi-element analyses. Further information on the technique can be found in the additional reading.

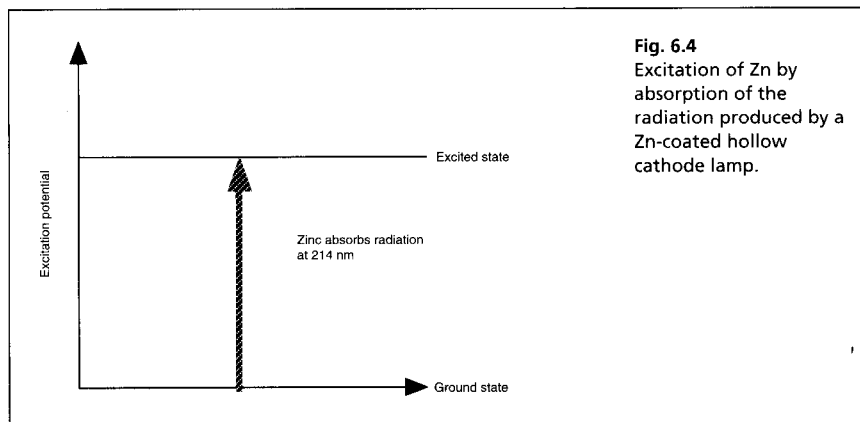

Instrumentation

An atomic absorption spectrophotometer (Fig. 6.5) consists of the following components:

- (i) *Light source.* A hollow cathode lamp coated with the element being analysed.
- (ii) *Flame.* The flame is usually air/acetylene providing a temperature *ca* 2500°C. Nitrous oxide/acetylene may be used to produce temperatures up to 3000°C, which are required to volatilise salts of elements such as aluminium or calcium.
- (iii) *Monochromator.* The monochromator is used to narrow down the width of the band of radiation being examined and is thus set to monitor the wavelength being emitted by the hollow cathode lamp. This cuts out interference by

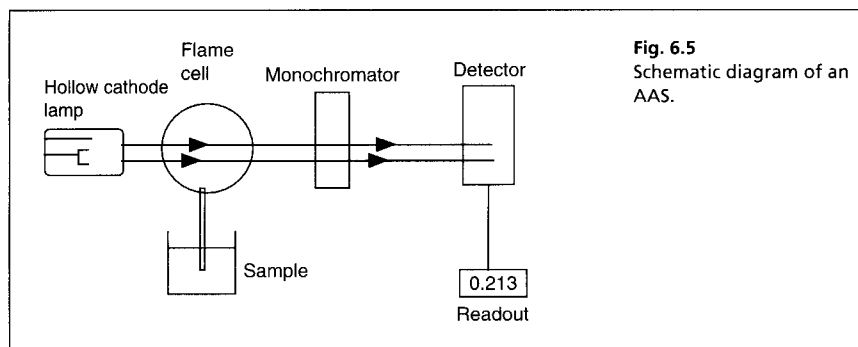

radiation emitted from the flame, from the filler gas in the hollow cathode lamp and from other elements in the sample.

- (iv) *Detector*. The detector is a photosensitive cell.

Examples of assays using AAS

AAS is used principally in limit tests for metals in drugs prior to their incorporation into formulations. The sample is generally dissolved in 0.1 M nitric acid to avoid formation of metal hydroxides from heavy metals, which are relatively involatile and suppress the AAS reading.

Assay of calcium and magnesium in haemodialysis fluid

The calcium (Ca) and magnesium (Mg) in a haemodialysis solution were analysed using atomic absorption spectrophotometry as follows:

- (i) Standard solutions containing Ca at a concentration of 10.7 mg/100 ml of water and containing Mg at a concentration of 11.4 mg/100 ml of water were diluted as follows.
- (ii) Dilution: 10 ml of both solutions were transferred to the same 100 ml volumetric flask and diluted to 100 ml (diluted standard solution).
- (iii) The calibration series was prepared by diluting the diluted standard solution with water as indicated in Table 6.3.

Table 6.3 Data obtained from assay of Ca and Mg by AAS

Volume taken for dilution (ml)	Final volume (ml)	Readings for Ca dilution series	Readings for Mg dilution series
0	100	0.002	0.005
5	100	0.154	0.168
10	100	0.310	0.341
15	100	0.379	0.519
20	100	0.619	0.685
25	100	0.772	0.835

Note:

- The dialysis solution was diluted from 5 to 250 ml before analysis of Ca
- Atomic absorption reading obtained for Ca = 0.343
- The dialysis solution was diluted from 10 to 100 ml before analysis of Mg
- Atomic absorption reading obtained for Mg = 0.554
- Ca atomic weight = 40
- Mg atomic weight = 24
- Calculate the concentration of Ca in the dialysis solution in mmol l⁻¹.

Calculation example 6.3

Concentration of Ca standard solution = 10.7 mg/100 ml.

Initially both solutions were diluted 10 to 100 ml ($\times 10$).

Thus the concentration of Ca in the diluted standard solution = 1.07 mg/100 ml.

For point 2 on the calibration curve, 5 ml of the diluted standard solution were diluted to 100 ml ($\times 20$).

Concentration of Ca used for point 2 = $\frac{1.07}{20} = 0.0535$ mg/100 ml.

Points 3, 4, 5 and 6 are $\times 2$, $\times 3$, $\times 4$ and $\times 5$, this value giving the following concentrations: 0.107, 0.165, 0.2140 and 0.2675 mg/100 ml.

In conjunction with the absorption readings these values were used to plot a calibration curve for Ca.

The equation obtained for the calibration line was:

$$y = 2.664x - 0.007$$

Reading for Ca in the diluted dialysis solution = 0.343.

From the equation for the calibration line the concentration of Ca in the diluted dialysis solution = 0.1314 mg/100 ml.

The dialysis solution was diluted 5 to 250 ml ($\times 50$) for Ca analysis.

Therefore concentration of Ca in the undiluted dialysis solution =

$$6.57 \text{ mg/100 ml} = 65.7 \text{ mg/l} = \frac{65.7}{40} \text{ mmoles/l} = 1.643 \text{ mmoles/l.}$$

Self-test 6.4

From the data given above calculate the concentration of mg in the haemodialysis solution in mmoles/l.

Answer: From computer fitting of the calibration line mg = 0.770 mmoles/l

Self-test 6.5

Zinc (Zn) is added to insulin to retard its rate of absorption into the bloodstream. The total concentration of Zn in Zn insulin suspension is determined by atomic absorption spectrophotometry. From the following data calculate the total concentration of Zn in a Zn insulin suspension in percentage of w/v from the following data:

- Concentration of Zn in the standard solution used to prepare the calibration line = 50.5 mg/100 ml.
- Dilution 1: 5 ml of standard solution were diluted to 500 ml with 0.01 M HCl (diluted standard solution).
- The calibration line was prepared as follows: 10, 20, 30, 40 and 50 ml amounts of diluted standard solution were diluted to 100 ml with 0.01 M HCl.
- The following absorption readings were obtained: 0.151, 0.313, 0.454, 0.605 and 0.755. 2 ml of the Zn insulin suspension (100 units/ml) were diluted to 200 ml with 0.01 M HCl and the following reading was obtained: 0.595.

Answer: 0.01983% w/v

Some examples of limit tests employing AAS

Assay of lead in sugars

AAS is used in BP assays to conduct limit tests for lead and nickel in sugars and polyols. In this case, the concentrations of the metals are very low compared with the concentration of the sugar and thus it is not even possible to compensate for the interference by the sugar using the method of standard additions. In this case, the lead is extracted from a solution of the sugar by forming an organosoluble complex with ammonium pyrrolidinedithiocarbamate (APDC) and by then extracting the complex into organic solvent. The solution of the metal complex in the organic solvent is then assayed by AAS in comparison with a series of standards added to the sugar solution to form a calibration series based on the method of standard additions.

A limit test for lead in mannitol (the BP limit is set at 0.5 ppm) was carried out as follows:

- (i) A solution containing 100 g of mannitol in 250 ml of water was prepared.
- (ii) A standard solution containing 101.4 mg/100 ml of lead was prepared with 0.01 M HNO₃.
- (iii) 10 ml of this solution was diluted to 1000 ml (diluted standard solution).
- (iv) 4 × 50 ml aliquots of the mannitol solution were mixed, respectively, with: (a) 0, (b) 0.5 ml, (c) 1.0 ml and (d) 1.5 ml of diluted standard solution.
- (v) Each sample was then mixed with a solution of APDC and the samples were then extracted with 10 ml 4-methylpentan-2-one. The organic layer was then separated and was then analysed by AAS.
- (vi) The following readings were obtained: (a) 0.057, (b) 0.104 (c) 0.156 and (d) 0.217.

Calculate the lead content in the mannitol in ppm: ppm = μg/g of substance.

Calculation example 6.4

Diluted lead standard solution contains $\frac{101.4}{10} = 10.4 \text{ mg}/100 \text{ ml} = 0.0104 \text{ mg/ml} = 10.4 \text{ } \mu\text{g/ml}$.

101.4 g of mannitol were dissolved in 250 ml of solution, therefore in each 50 ml aliquot there was 20.28 g.

The amount of lead added to the four samples was: 0, $0.5 \times 10.4 = 5.2 \text{ } \mu\text{g}$, $1 \times 10.4 = 10.4 \text{ } \mu\text{g}$ and $1.5 \times 10.4 = 15.6 \text{ } \mu\text{g}$.

The equation for the line obtained by plotting amount of lead added against the readings is:

$$y = 0.010x + 0.054 \quad (r = 0.998).$$

The negative intercept ($y = 0$) gives the content of lead in the sample.

$$x = \frac{0.054}{0.01} = 5.4 \text{ } \mu\text{g}.$$

5.4 μg of lead is present in a solution containing 20.28 g of mannitol.

$$\text{Lead content in the mannitol} = \frac{5.4}{20.28} = 0.266 \text{ } \mu\text{g/g} = 0.266 \text{ ppm}.$$

Self-test 6.6

The procedure used to determine lead in mannitol was also used to determine nickel in a sample of mannitol. Calculate the content of nickel in a sample of mannitol from the following data:

- 100.5 g of mannitol was dissolved in 250 ml of water.
- A standard solution containing nickel at 10.6 ppm ($10.6 \mu\text{g/ml}$) was used to prepare a calibration series by adding 0.5 ml, 1.0 ml and 1.5 ml of the standard to 50 ml aliquots of the mannitol solution.
- The following readings were obtained: 0.378, 0.543, 0.718, 0.891. Calculate the content of nickel in ppm in the sample of mannitol.

Answer: 0.58 ppm

Trace metals in a silicone foam cavity wound dressing

This expandable wound dressing is prepared by mixing a silicone elastomer with an organotin catalyst to form an expandable dressing immediately prior to application. Most of the tin is not extractable from the dressing matrix but a limit test for extractable tin is carried out as follows:

- (i) 5 g of dressing cut into pieces is shaken with 50 ml of 0.9% w/v sodium chloride for 4 h.
- (ii) The solution is filtered and the tin is determined by AAS using a nitrous oxide/acetylene flame and measuring the absorption at 235.5 nm. The limit set for the tin is 6 ppm ($6 \mu\text{g/g}$).
- (iii) The same solution is used to determine whether the sample passes 5 ppm limits for cadmium, copper, lead and zinc but using an air/acetylene flame and using the lamps appropriate for the detection of these elements.

Applications of AAS in BP assays

AAS is used in a number of limit tests for metallic impurities, e.g.: magnesium and strontium in calcium acetate; palladium in carbenicillin sodium and lead in bismuth subgallate. It is also used to assay metals in a number of other preparations: zinc in zinc insulin suspension and tetracosactrin zinc injection; copper and iron in ascorbic acid; zinc in acetylcysteine; lead in bismuthsubcarbonate; silver in cisplatin; lead in oxyprenolol; aluminium in albumin solution and calcium, magnesium, mercury and zinc in water used for diluting haemodialysis solutions.

Inductively coupled plasma emission spectroscopy

If high enough temperatures can be reached, any element can be excited to a level where it will produce emission of radiation. Such high temperatures can be achieved by using plasma emission. A schematic diagram of an inductively coupled plasma (ICP) 'torch' is shown in Figure 6.6.

High temperatures are achieved by heating argon with high intensity radiofrequency radiation. At such high temperatures all elements will emit radiation as they are excited and then return to the ground state. In order to derive spectral information from the process an efficient monochromator and computer processing of the data are required in order to unscramble the large number of lines that are derived from a particular sample. ICP has been used to determine a complex of the metal ion dysprosium, which is used as a magnetic resonance imaging contrast agent, in serum.¹

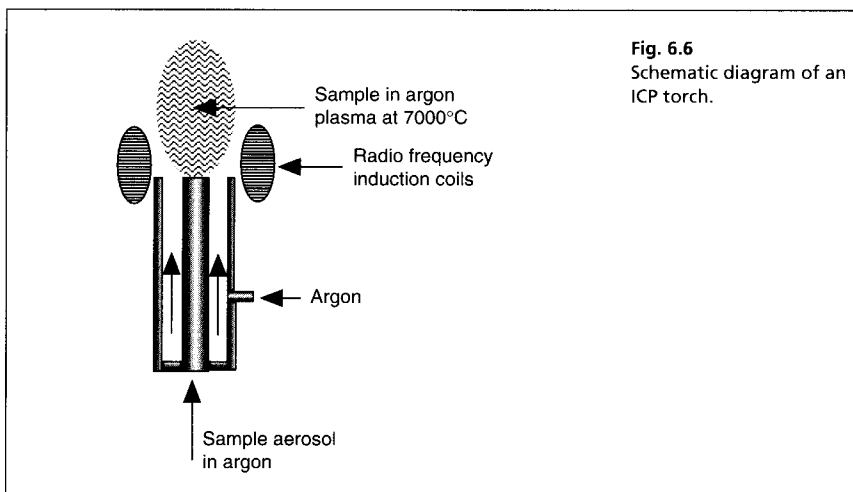

Fig. 6.6
Schematic diagram of an ICP torch.

References

1. J-J Lai and G.C. Jamieson. *J. Pharm. Biomed. Anal.* 11, 1129–1134 (1993).

Further reading

Practical Pharmaceutical Chemistry Vol 2. A.H. Beckett and J. Stenlake, eds. Athlone Press, London (1988).

Applications of Atomic Spectrometry to Regulatory Compliance Monitoring, 2nd Edn. S.W. Jenniss, S.A. Katz and R.W. Lynch, eds. A Wiley-VCH Publication, Chichester (1997).

Atomic Absorption and Plasma Spectroscopy, 2nd Edn. J.R. Dean and D.J. Ando, eds. J. Wiley and Sons, Chichester (1997).

7

Molecular emission spectroscopy

Fluorescence spectrophotometry

Keypoints

Introduction

Instrumentation

Molecules which exhibit fluorescence

Factors interfering with fluorescence intensity

Applications of fluorescence spectrophotometry in

pharmaceutical analysis

Determination of ethinyloestradiol in tablets

Determination of the dissolution rate of digoxin tablets

Determination of aluminium in water for injection as a fluorescent complex

Determination of stability of peptide drugs in solution

Fluorescent derivatives and flow injection analysis

Raman spectroscopy

Keypoints

Introduction

Instrumentation

Applications

Rapid fingerprinting of drugs

Analysis of drugs in their formulations

A quantitative application

Fluorescence spectrophotometry

KEYPOINTS

Principles

- Certain molecules, particularly those with a chromophore and a rigid structure, can be excited by UV/visible radiation, and will then emit the radiation absorbed at a longer wavelength. The radiation emitted can then be measured.

Applications

- Determination of fluorescent drugs in low-dose formulations in the presence non-fluorescent excipients.
- In carrying out limit tests where the impurity is fluorescent or can be simply rendered fluorescent.
- Useful for studying the binding of drugs to components in complex formulations
- Widely used in bioanalysis for measuring small amounts of drug and for studying drug-protein binding.

Strengths

- A selective detection method and can be used to quantify a strongly fluorescent compound in the presence of a larger amount of non-fluorescent material.
- Can be used to monitor changes in complex molecules such as proteins which are being used increasingly as drugs.

Limitations

- The technique only applies to a limited number of molecules.
- Fluorescence is subject to interference by UV absorbing species, heavy ions in solution, and is affected by temperature.

Introduction

Figure 7.1 illustrates the behaviour of an excited electron in a fluorescent molecule. In a non-fluorescent molecule when an electron is excited to the electronic excited state, it returns back to the ground state by losing the energy it has acquired through conversion of the excess electronic energy into vibrational energy. If a molecule has a rigid structure the loss of electronic energy through its conversion into vibrational energy is relatively slow and there is a chance for the electronic energy to be emitted as ultraviolet or visible radiation. The energy emitted is of lower energy than the energy absorbed because, as indicated in Figure 7.1, the excited electron moves to the lowest energy vibrational state in the excited state before returning to the ground state. Thus fluorescence emission is typically shifted by 50–150 nm towards a longer wavelength in comparison with the wavelength of the radiation used to produce excitation. The fluorescence spectrum of a molecule is, ideally, a mirror image of the longest wavelength band in the absorption spectrum of the molecule but often the spectrum is distorted due to partial overlap between the absorption and the emission spectra. Vibrational fine structure of the fluorescence band may be observed if the molecule does not interact with the solvent strongly (cf. UV spectra) and can be observed in the fluorescence spectra of polycyclic aromatic hydrocarbons such as anthracene. The shape of the fluorescence spectrum is independent of the wavelength used for excitation since the transition producing the fluorescence spectrum is always from the first excited state to the ground state. In a molecule containing a number of UV absorption bands, the longest wavelength maximum is the one associated most strongly with the production of fluorescence. In addition, the wavelength usually used to produce excitation is close to the λ_{max} of the longest wavelength absorption band in the spectrum of the analyte.

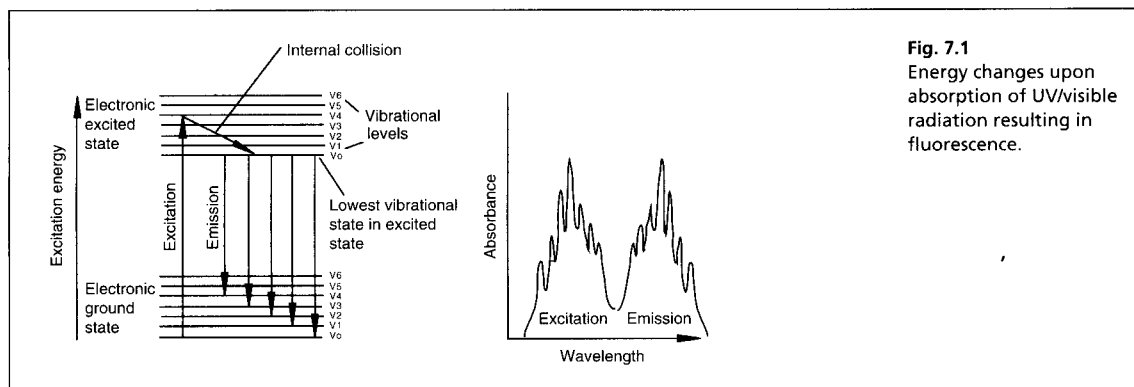

Fig. 7.1
Energy changes upon absorption of UV/visible radiation resulting in fluorescence.

Instrumentation

Figure 7.2 shows a schematic diagram of a fluorescence spectrophotometer. Since emission is being observed the light being emitted is observed at right angles to the light being used to excite the sample.

The instrument has two monochromators: one to select the wavelength to be used for excitation of the sample, the other to scan the wavelength range of the light emitted by the sample.

The lamp used, which is a quartz halogen lamp, produces radiation of high intensity to take advantage of the fact that the strength of the fluorescence is related to

the number of photons absorbed multiplied by the fluorescence quantum yield (ϕ). For strongly fluorescent compounds, ϕ is close to 1; for non-fluorescent compounds $\phi = 0$. The wavelength which gives maximum excitation is not necessarily exactly the same as the longest wavelength absorbance maximum in the compound since the intensity of light emitted by the quartz halogen lamp varies markedly with wavelength, unlike the deuterium and tungsten lamps used in UV/visible spectrophotometers. The lamp gives radiation of maximum intensity between 300 and 400 nm.

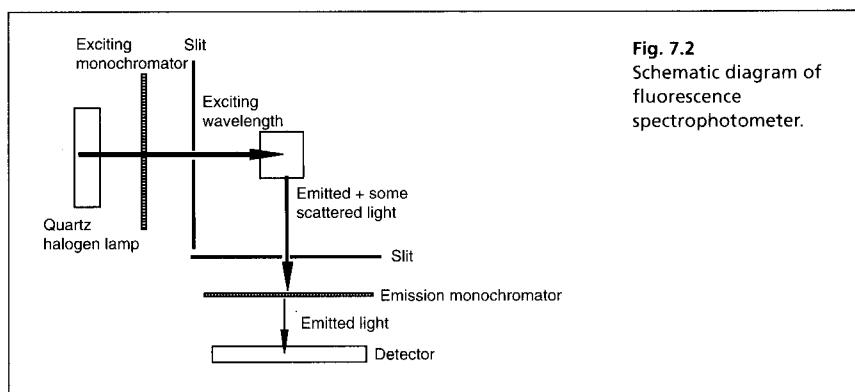

Although the radiation emitted is observed at right angles to the exciting radiation, some of the exciting radiation can be detected by the emission detector because it is scattered by solvent molecules (Rayleigh scatter) or by colloidal particles in solution (Tyndall scatter). The presence of this scatter makes the use of the second monochromator necessary and also means that the fluorescence band has to be shifted by at least 20 nm beyond the excitation band for fluorescence measurements to be made without interference. Another, weaker, type of scatter which may be observed is Raman scatter. In Raman scatter, which is solvent dependent, the wavelength of the incident radiation is shifted to a longer wavelength by about 30 nm when methanol is used as a solvent and about 10 nm when chloroform is used as a solvent. Raman scatter is discussed in more detail later in this chapter.

Molecules which exhibit fluorescence

It is not entirely possible to predict how strongly fluorescent a molecule will be. For example adrenaline and noradrenaline differ in their structures by only a single methyl group but noradrenaline exhibits fluorescence nearly 20 times more intensely than adrenaline. Generally, fluorescence is associated with an extended chromophore/auxochrome system and a rigid structure. Quinine (Fig. 7.3) is an example of a strongly fluorescent molecule as might be expected from its extended chromophore and rigid structure. The chromophore in ethinyloestradiol is just an aromatic ring but the presence of a phenolic hydroxyl group in combination with rigid ring structure in the rest of the molecule renders it fluorescent (Fig. 7.3).

Figure 7.4 shows the fluorescence spectrum of ethinyloestradiol. When the fluorescence spectrum of the molecule is scanned with a wavelength of 285 nm being used for excitation, two maxima are seen. The maxima at 285 nm is due to scatter of the exciting radiation and the second more intense maximum at 310 nm is

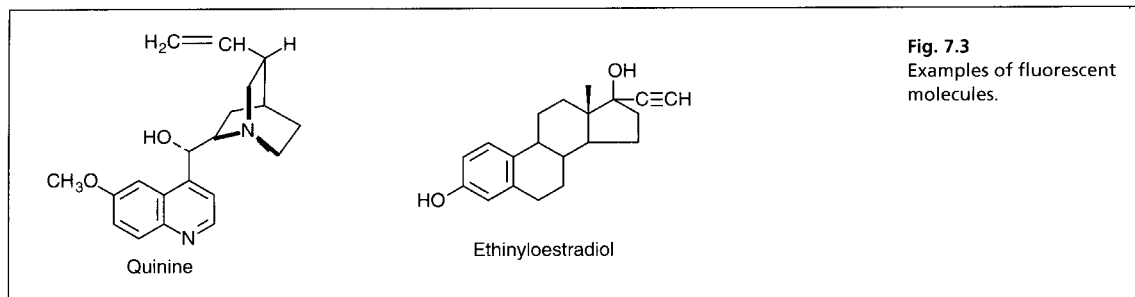

Fig. 7.3
Examples of fluorescent molecules.

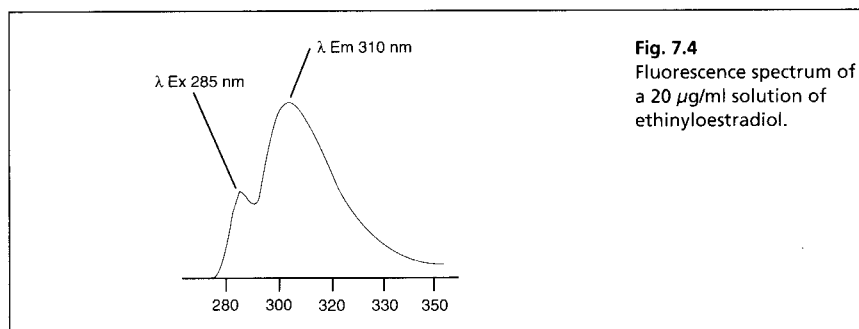

Fig. 7.4
Fluorescence spectrum of a 20 $\mu\text{g/ml}$ solution of ethinyloestradiol.

due to fluorescence. The separation of the exciting radiation and emitted radiation is not great in this example, but this is partly because excitation is taking place at a relatively short wavelength where the displacement of wavelength with energy is lower. For example, the difference between 285 and 310 nm is 0.35 eV, whereas with an excitation wavelength at 385 nm, an energy displacement of 0.35 eV would give an emission wavelength at 443 nm.

Like ethinyloestradiol many other phenols exhibit fluorescence and as is the case for ethinyloestradiol, this fluorescence is pH dependent and does not occur under alkaline conditions when the phenolic group becomes ionised. Table 7.1 shows some examples of fluorescent drug and vitamin molecules.

Table 7.1 Examples of drugs which yield fluorescence spectra

Compound	Excitation	Emission	Limit of detection $\mu\text{g/ml}$
Pentobarbitone	265	440	0.1
Adrenaline	295	335	0.1
Chlorpromazine	350	480	0.1
Riboflavin	444	520	0.01
Procaine	275	245	0.01
Noradrenaline	285	325	0.006
Quinine	350	450	0.002

Factors interfering with fluorescence intensity

If the concentration of a solution prepared for fluorescence measurement is too high, some of the light emitted by the sample as fluorescence will be reabsorbed by other unexcited molecules in solution. For this reason, fluorescence measurements are best made on solutions with an absorbance of less than 0.02 at their maximum, i.e. solutions of a sample 10–100 weaker than those which would be used for measurement by UV spectrophotometry.

Heavy atoms in solution quench fluorescence by colliding with excited molecules so that their energy is dissipated, e.g. chloride or bromide ions in solution cause collisional quenching.

Formation of a chemical complex with other molecules in solution can change fluorescence behaviour, e.g. the presence of caffeine in solution reduces the fluorescence of riboflavin. This alteration of fluorescence upon binding is used to advantage when examining binding of fluorescent molecules to proteins or other constituents of cells.

Applications of fluorescence spectrophotometry in pharmaceutical analysis

Determination of ethinyloestradiol tablets

The BP utilises a fluorescence assay to determine ethinyloestradiol in tablets. The tablets contain low dosages of the drug so that interference by excipients is likely to cause problems in UV/visible spectrophotometric measurements. The sample is measured using an excitation wavelength of 280 nm and measuring the emission at 320 nm. As was seen when the fluorescence spectrum of ethinyloestradiol was discussed earlier, the optimum excitation wavelength for ethinyloestradiol is 285 nm and the emission maximum is 310 nm. Thus, this assay as described brings out two important points that may have been either consciously or empirically adjusted for in the design of the assay:

- (i) The use of a slightly shorter excitation wavelength reduces possible interference from Raman scatter, which may overlap with the fluorescence spectrum and is dependent on the wavelength of the exciting radiation, whereas the fluorescence maximum is not.
- (ii) The intensity of Rayleigh and Tyndall scatter at shorter wavelengths is greater and thus the emission is observed at the slightly longer wavelength of 320 nm to reduce interference from this source.

After the fluorescence of the sample extract in methanol has been determined, 1 M sodium hydroxide solution is added to the sample solution and the fluorescence is determined again. The addition of sodium hydroxide removes the fluorescence by ionising the phenol group of the ethinyloestradiol and thus any residual fluorescence which is due to excipients can be subtracted from the reading. In the BP assay the ethinyloestradiol content of the tablet extract is determined by comparison with the fluorescence of a solution containing a known amount of ethinyloestradiol standard analysed using the same conditions.

Calculation example 7.1

A methanolic extract from ethinyloestradiol tablets is measured using fluorescence spectrophotometry. A standard containing the pure drug is also measured under the same conditions. Calculate the content per tablet of the drug from the following data:

Weight of 20 tablets = 2.5673 g.

Weight of tablet powder taken for assay = 0.5257 g.

Volume of methanol extract of tablets = 50 ml.

Fluorescence reading of methanol extract of tablets = 64.1.

Fluorescence reading of sample after addition of 0.1 M NaOH = 3.5.

Concentration of standard solution of ethinyloestradiol = 4.85 $\mu\text{g/ml}$.

Fluorescence reading of standard solution = 62.3.

Fluorescence reading of standard solution after addition of 0.1 M NaOH = 4.1.

Corrected reading for tablet extract = 64.1 – 3.5 = 60.6.

Corrected reading for standard = 62.3 – 4.1 = 58.2.

Amount of ethinyloestradiol in tablet extract = $60.2/58.2 \times 4.85 = 5.02 \mu\text{g/ml}$.

Total amount in extract = $50 \times 5.02 = 251 \mu\text{g}$.

Number of tablets in tablet powder analysed = $2.5673/0.5257 = 4.884$.

Content of ethinyloestradiol per tablet = $251/4.885 = 51.4 \mu\text{g}$.

Determination of dissolution rate of digoxin tablets

Some compounds which are not naturally fluorescent can be rendered fluorescent by simple chemical reactions. For instance digoxin can be converted to a fluorescent derivative by dehydration with HCl and followed by oxidation with H_2O_2 . The drug has a narrow therapeutic index and it is important to ensure that the correct dose of drug is delivered by the dosage form. To ensure effective release of the drug from the tablet matrix, the BP indicates that dissolution testing should be carried out. The drug is given in low dosage (*ca* 100 μg per tablet) making measurement of the concentration released into the dissolution medium difficult. The BP assay for release indicates that 75% of the drug from six tablets should be released into 600 ml of dissolution medium after 2 h. The fluorescence measurements are made on the dissolution medium after derivative formation using an excitation wavelength of 360 nm and an emission wavelength of 490 nm. The drug in solution is quantified in comparison with a solution containing a known concentration of standard treated in the same way as the sample.

Determination of aluminium in water for injection as a fluorescent complex

Fluorescence measurements are useful in limit tests where the trace impurity is fluorescent or can be rendered fluorescent by chemical modification. An example is the determination of aluminium in water for use in haemodialysis solutions by formation of its salt with 8-hydroxyquinoline (Fig. 7.5) followed by quantification of the complex using fluorescence spectrophotometry. The excitation wavelength is set at 392 nm and the emission is measured at 518 nm. This type of fluorescent complex can be used to determine low levels of a number of metal ions.

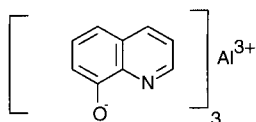

Aluminium hydroxyquinolone salt

Fig. 7.5
Fluorescent complex of
aluminium.

Determination of stability of peptide drugs in solution

The structural complexity of peptide drugs which are being produced increasingly by biotechnology means that additional quality control checks are necessary both for low level contaminants such as immunogenic proteins and for changes in the tertiary (three-dimensional) structure of the protein in solution which may affect its activity. During stability studies, peptide drugs are likely to form aggregates and this eventually results in precipitation. Such changes can alter the efficacy of the drug. In addition it is important to monitor for the inhibition of such changes where stabilisers and other formulation aids are added to the protein solution. Fluorimetry provides a method of following such changes in solution and was recently used in a study of the stability of recombinant fibroblast growth factor in solution.¹

Fluorescence in this peptide is largely due to the presence of tyrosine residues (excitation 277 nm and emission 305 nm) and a tryptophan residue (excitation 290 nm and emission 350 nm) in its structure. Protein denaturation is accompanied by a gradual fall in the emission peak of the tyrosine residues at 305 nm and a gradual rise in the emission peak of the tryptophan residue at 350 nm. This effect is shown in Figure 7.6 and illustrates the fact that the strength of fluorescence is dependent on the local environment of the chromophore.

Measurement of the effect was found to be capable of quantifying the amount of denatured protein in solution.

Fig. 7.6

The effect of denaturation on the fluorescence spectrum of fibroblast growth factor. An excitation spectra of native and denatured bFGF B Emission spectra of native and denatured bFGF. Reproduced with permission from J. Pharm. Biomed. Anal. (See Reference 1).

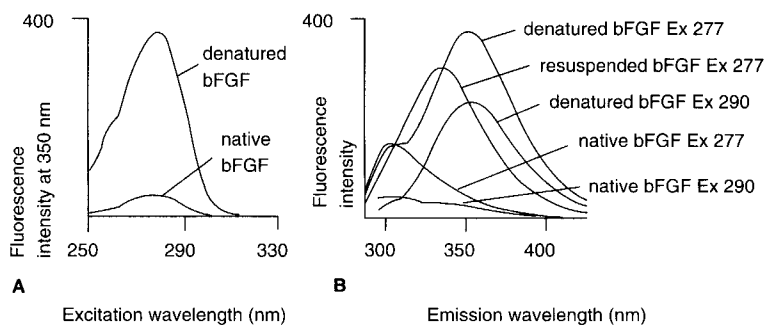

Fluorescent derivatives and flow injection analysis

Flow injection analysis is discussed in more detail in Chapter 3. Some simple chemical reactions which result in the formation of fluorescent derivatives are shown in Table 7.2. All of these reactions could be adapted to enable analysis by FIA.

Table 7.2 Examples of chemical conversion of drug molecules into fluorescent derivatives

Compound	Reagent	Excitation nm	Emission nm
Adrenaline	$K_3Fe(CN)_6$	410	530
Primary amines/amino acids	Fluorescamine	380	480
Chlorpheniramine	H_2O_2	350	436
Fluphenazine	H_2O_2	350	405

Raman spectroscopy

KEYPOINTS

Principles

- The Raman effect is analogous to fluorescence except that it is not wavelength dependent and does not require the molecule to have a chromophore. The energy shift in cm^{-1} due to inelastic scattering of laser radiation is measured rather than wavelength. The shifts measured correspond to the wavenumbers of the bands present in the middle-IR spectrum of the molecule.

Applications

- Has potential for identifying complex samples, e.g. drugs in formulations and in pack
- Samples such as peptide pharmaceuticals can be analysed for changes in their three-dimensional structure
- Provides additional fingerprint identity information complementary to middle-IR spectroscopy.

Strengths

- Complementary to middle-IR spectroscopy but requires very little sample preparation since near-infrared (NIR) radiation with its good penetration properties can be used for the analysis
- Increasingly a readily available option on middle-IR FT-IR instruments.

Limitations

- Not yet fully established as a quantitative technique
- The solvent may interfere if samples are run in solution.

Introduction

All molecules can be polarised so that the electrons within them are displaced slightly in the direction of the applied field. This effect is not subject exactly to the laws of quantum mechanics, but the wavenumber of the displacement of radiation by a particular group is the same as the wavenumber of the radiation absorbed by that particular group in middle-IR spectroscopy. In fact the Raman effect is encountered when making fluorescence measurements in the UV visible region, although it is usually weak in comparison with Rayleigh and Tyndall scatter. It is analogous to fluorescence except that it is not wavelength dependent, does not require the molecule to have a chromophore and the energy shift in cm^{-1} is measured rather than in wavelength. Figure 7.7 illustrates the Raman effect; the radiation can be either shifted to slightly higher energy (anti-Stokes shift) or to slightly lower energy (Stokes shift). The Stokes shift is usually determined in Raman spectroscopy.

Comparison of the FT-Raman spectrum and FT-IR spectra of dichloroacetophenone (Fig. 7.8) illustrates the fact that the Raman shift for a particular group is similar in energy to the energy of IR absorption for the group in the middle-infrared region.² The two spectra provide complementary information.

The general rule is that those bands that absorb weakly in the middle-IR region will absorb strongly in the Raman region and vice versa. For example in dichloroacetophenone, it can be seen that the aromatic C-H groups which absorb IR radiation weakly give a strong Raman effect while the C=O group in the structure absorbs IR radiation strongly but gives a weak Raman effect.

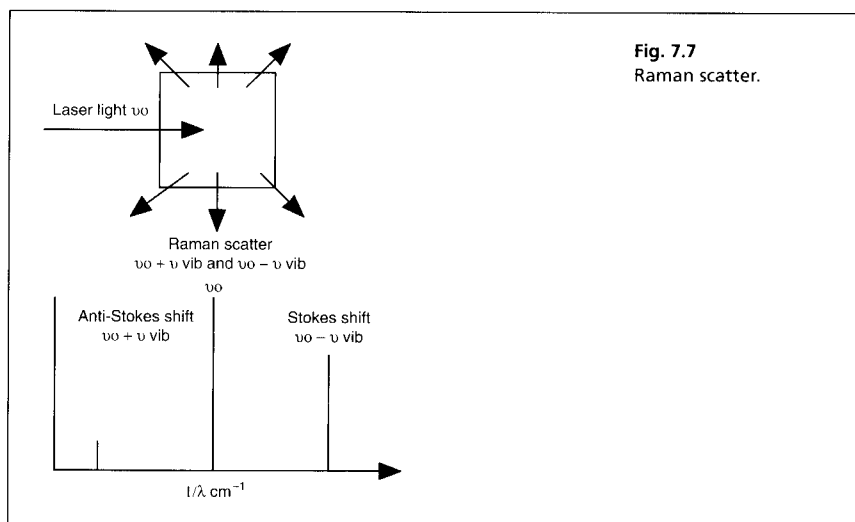

Fig. 7.7
Raman scatter.

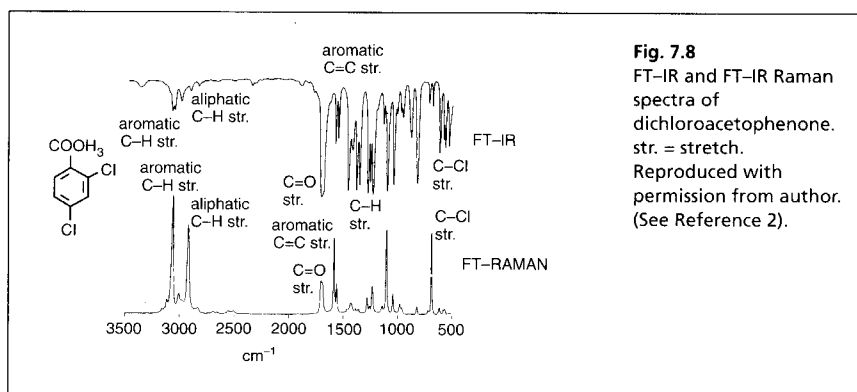

Fig. 7.8
FT-IR and FT-IR Raman spectra of dichloroacetophenone. str. = stretch. Reproduced with permission from author. (See Reference 2).

Instrumentation

The geometry of a Raman spectrometer (Fig. 7.9) is analogous to that for a fluorescence instrument. Since the Raman effect is weak but proportional to the intensity of energy applied, lasers are used to provide high-intensity radiation in the visible region, generally somewhere between 450 and 800 nm. Lasers provide several emission lines and in the case of a fluorescent molecule a line may be selected that gives Raman scatter where fluorescence does not interfere with the measurement. In recent years NIR lasers in conjunction with Fourier transform instruments have become available.² The use of NIR radiation has two advantages:

- (i) Unlike UV/visible radiation, it does not excite fluorescence in molecules which can result in interference in measurements.
- (ii) It has good penetration properties so that a sample in the solid phase can be examined without any sample preparation.

NIR Raman spectroscopy has good potential for the analysis of pharmaceutical formulations and biological materials.

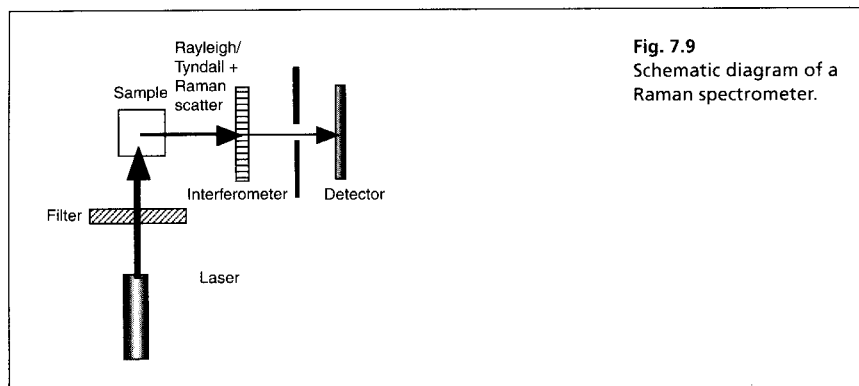

Fig. 7.9
Schematic diagram of a Raman spectrometer.

Applications

Rapid fingerprinting of drugs

The Raman spectra of heroin, morphine and codeine (Fig. 7.10) are highly characteristic because of the change in the bands due to the aromatic ring.² The FT-IR spectra of these compounds are quite similar. Near-infrared Raman spectroscopy can provide a rapid method for characterising drugs with minimal sample preparation and analysis time.

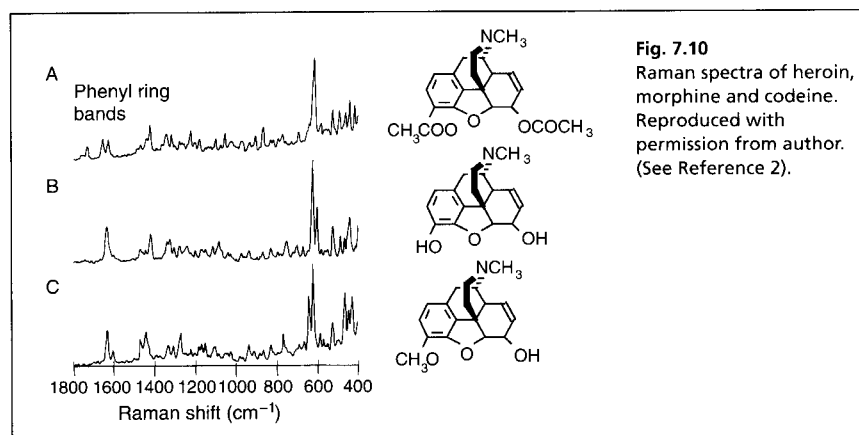

Fig. 7.10
Raman spectra of heroin, morphine and codeine. Reproduced with permission from author. (See Reference 2).

Analysis of drugs in their formulations

Drugs can be characterised directly in formulated materials. For example diclofenac formulated in sodium alginate was characterised by subtracting the spectrum of the alginate matrix from the spectrum of the formulation containing diclofenac (Fig. 7.11). It is also possible to analyse drugs which are packaged by subtracting the spectrum of the pack. This allows for instance a final quality control (QC) check on, for instance, blister-packed tablets.

A quantitative application

FT-Raman is potentially a quantitative technique but does not currently have the

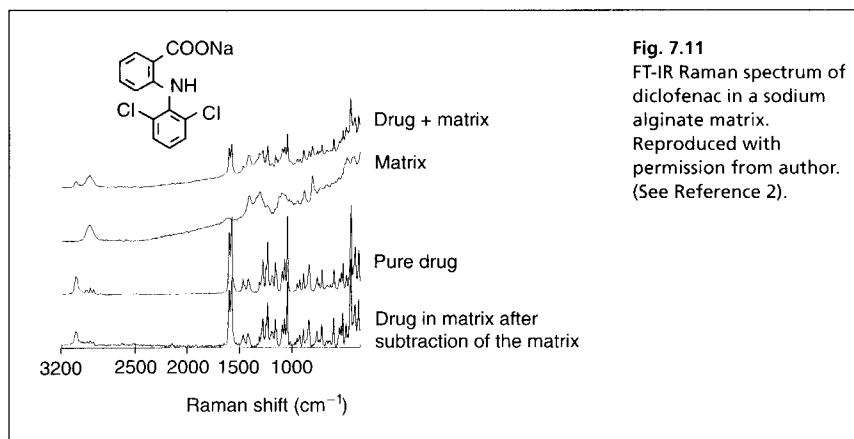

Fig. 7.11
FT-IR Raman spectrum of diclofenac in a sodium alginate matrix. Reproduced with permission from author. (See Reference 2).

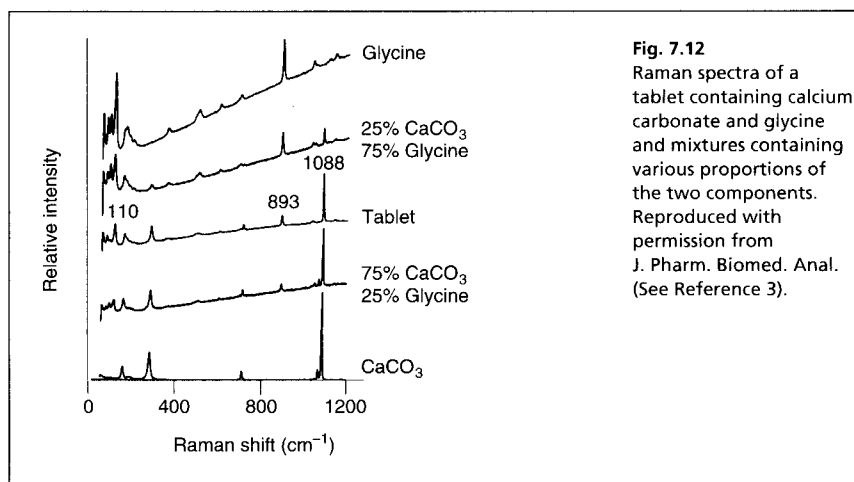

Fig. 7.12
Raman spectra of a tablet containing calcium carbonate and glycine and mixtures containing various proportions of the two components. Reproduced with permission from J. Pharm. Biomed. Anal. (See Reference 3).

sensitivity of NIR when it comes to determination of individual components in complex mixtures. Raman spectroscopy was used to determine glycine and calcium carbonate in an antacid tablet.³ The intensity of the bands at 1088 cm^{-1} for calcium carbonate and 893 cm^{-1} for glycine were used as the basis for quantitation (Fig. 7.12). Precisions of $\pm 3.5\%$ were achieved for the contents of the ingredients in the tablet.

References

1. Z. Shahrokh, G. Eberlein and Y.J. Wang, J. Pharm. Biomed. Anal. 12, 1035–1041 (1994).
2. P. Hendra, C. Jones and G. Warnes. Fourier transform Raman spectroscopy. Ellis Horwood (1991).
3. C.G. Kontoyannis. J. Pharm. Biomed. Anal. 13, 73–76 (1995).

Further reading

Methods in Enzymology. Vol 278. L. Brand and M.L. Johnson, eds. Fluorescence Spectroscopy. Academic Press, London (1997).

Introductory Raman Spectroscopy. Vol 2. J.R. Ferraro and K. Nakamoto, eds. Academic Press, London (1994).

8

Nuclear magnetic resonance spectroscopy

Keypoints	Proton NMR spectrum of paracetamol	An example of a ^{13}C spectrum
Introduction		
Instrumentation	Proton NMR spectrum of aspirin	Two-dimensional NMR spectra
Proton NMR		A simple example
Chemical shifts	Proton NMR spectrum of salbutamol: A more complex example	A more complex example
Spin spin coupling		
Application of NMR to structure confirmation in some drug molecules	Carbon-13 NMR	Application of NMR to quantitative analysis
	Chemical shifts	Other specialised applications of NMR

KEYPOINTS

Principles

Radiation in the radiofrequency region is used to excite atoms, usually protons or carbon-13 atoms, so that their spins switch from being aligned with to being aligned against an applied magnetic field. The range of frequencies required for excitation and the complex splitting patterns produced are very characteristic of the chemical structure of the molecule.

Applications in pharmaceutical analysis

- A powerful technique for the characterisation of the *exact structure* of raw materials and finished products
- Can determine impurities, including enantiomeric impurities, without separation down to *ca* the 10% level
- Can potentially be used for fingerprinting mixtures
- Has good potential for quantitative analysis of drugs in formulations without prior separation.

Strengths

- Provides much more information about molecular structure than any other technique.

Limitations

- A relatively insensitive technique requiring > 5 mg of sample for proton nuclear magnetic resonance (NMR) and > 20 mg for carbon-13 NMR
- Expensive instrumentation requiring a specialist operator although automation is increasingly available for routine methods.

Introduction

The nuclei of certain atoms act as if they are spinning and this gives them the properties of a magnetic vector. Common nuclei with this property are ^1H ; ^{13}C ; ^{15}N ; ^{19}F ; ^{29}Si and ^{31}P . When such nuclei are placed in a magnetic field they will tend to align with the field (Fig. 8.1).

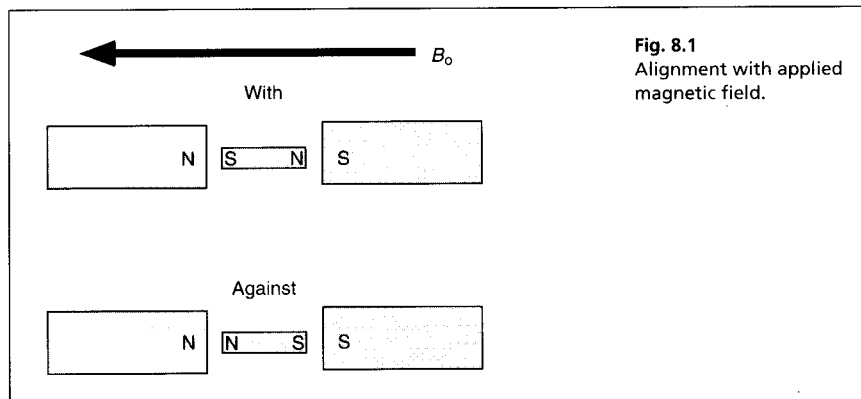

The energy difference between the spin being aligned with the field and against the field depends on the strength of the magnetic field applied. The greater the field strength the greater the energy difference ΔE :

$$\Delta E = h\gamma B_0$$

where h is Planks constant, γ is the magnetogyric ratio of a particular nucleus and B_0 is the applied magnetic field.

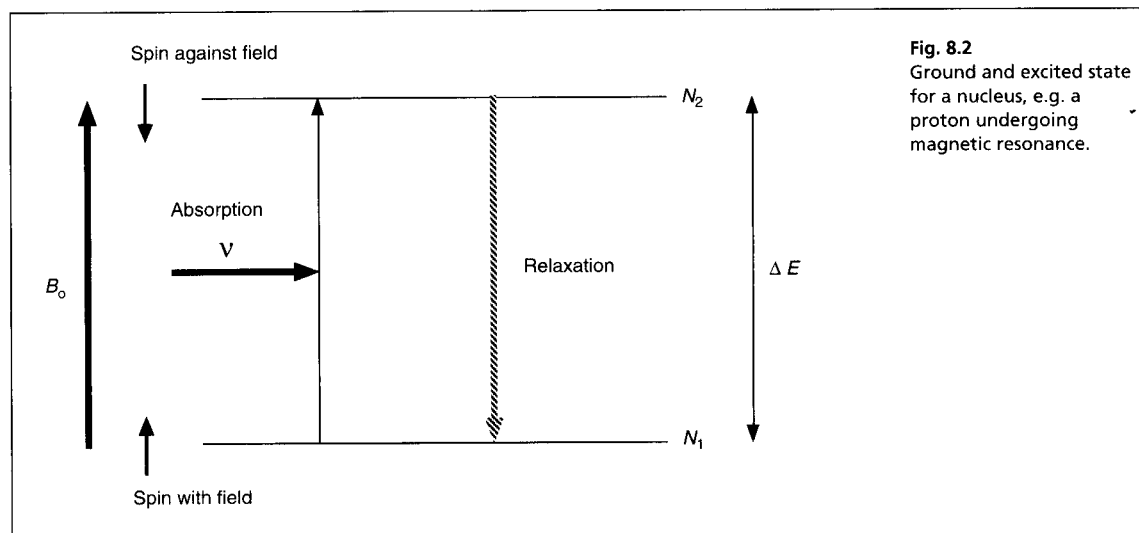

Figure 8.2 illustrates the absorption of energy to produce alignment against the applied magnetic field. Compared to other spectroscopic techniques, the energy difference between the ground and excited state is not large and thus ΔN , the difference between the number of protons in the low energy (N_1) and high energy (N_2), is very small. This is because the energy difference between the two states

is low relative to the thermal energy in the environment. This means that NMR is a relatively insensitive technique because the net energy absorption by the population of low energy protons in a sample is low. The wavelength of the radiation used in NMR is of low energy and is in the radiofrequency region. The units of energy used in NMR are in Hertz, which is a unit of frequency (c/λ , where $c = 3 \times 10^{10}$ cm/s and λ is in cm). The stronger the magnetic field applied the greater the radiation frequency in Hertz (the shorter the wavelength) required to cause the spin of a nucleus to align against the field. The values for the strength of the applied magnetic field are in the range 14 000–140 000 Gauss (1.4–14 Tesla). A proton in the ground state will absorb radiation having a frequency of *ca* 60 MHz at 1.4 T and *ca* 600 MHz at 14 T. NMR instruments are described in terms of the frequency at which they cause protons to resonate, thus a 600 MHz instrument is one which causes protons to resonate at a frequency of *ca* 600 MHz. At higher magnetic field strength greater sensitivity is obtained because of the greater difference in the populations of the higher and lower energy states. For a 60 MHz instrument the population difference between the ground and excited state for a proton is *ca* 1 in 100 000, whereas for a 600 MHz instrument the population difference is *ca* 1 in 10 000, i.e. about a 10-fold increase in sensitivity.

Instrumentation

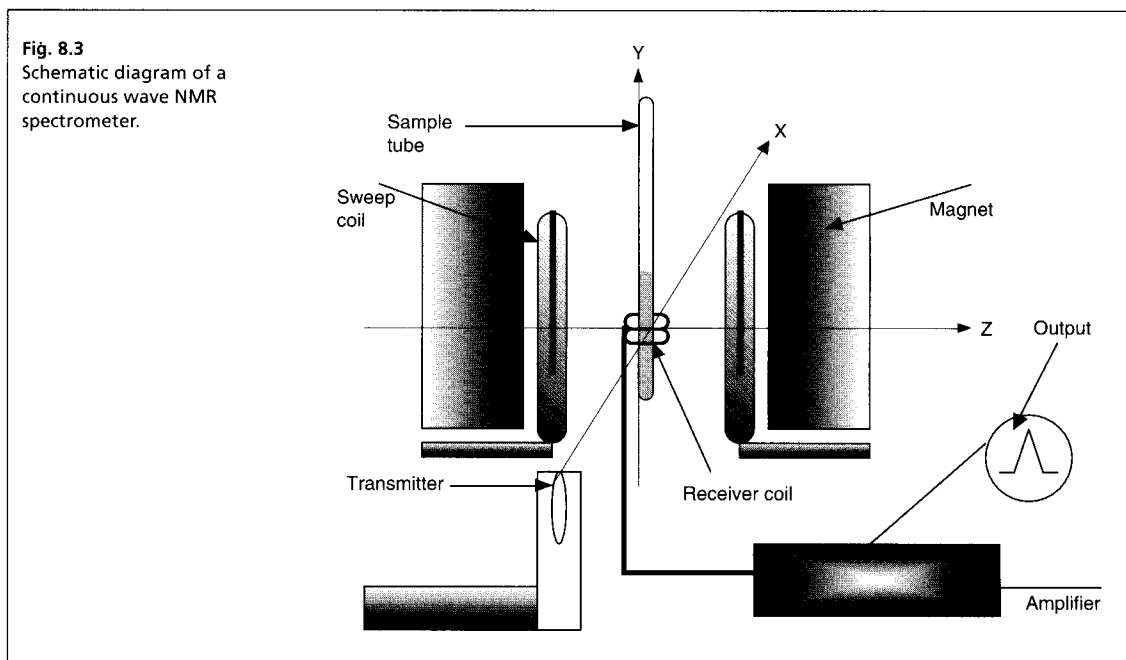

Figure 8.3 gives the basic layout of a continuous wave NMR spectrometer. These instruments were the original type of instrument and have largely been replaced by Fourier transform instruments. However, the principles of operation are broadly similar:

- (i) The sample is placed in a narrow glass NMR tube and is spun in the fixed magnetic field at *ca* 30 revolutions/s by means of an air turbine thus ensuring uniformity of the magnetic field across the sample in a horizontal direction. The sample is analysed in solution in a deuterated solvent to ensure there is no

interference from protons in the relatively much larger amount of solvent with the signal from the sample protons.

- (ii) The reference point of 0 parts per million (ppm) is determined by the frequency at which the protons in tetramethylsilane (TMS) absorb. Sometimes residual protons in the solvent are used to lock the protons in a spectrum, e.g. the residual proton in deuterated chloroform is at 7.25 ppm relative to TMS.
- (iii) In order to obtain a proton spectrum the radiofrequency radiation is swept across a range of *ca* 10 ppm, e.g. 1000 Hz when the magnetic field is recorded on a 100 MHz instrument or 6000 Hz when the spectrum is recorded on a 600 MHz instrument. The receiver coil measures the absorption of radiation as the frequency is swept over the range being examined.
- (iv) As well as determining the frequency at which protons in the molecule absorb, the instrument determines the area of each signal which is proportional to the number of protons absorbing radiation, e.g. three protons give an area three times as large as a signal due to one proton in the same molecule.
- (v) Modern instruments, rather than being based on a continuous wave, are based on a pulsed wave. In brief, the short powerful pulse used in this type of spectroscopy behaves as a spread of frequencies covering the Hz range of interest, e.g. the range in which protons resonate. Most of the principles of the continuous wave instrument still hold but rather than the absorption of radiation by the sample being observed emission is observed as the excited protons relax back to the ground state following the short high energy pulse of radiation. Thus spectra are accumulated using a high intensity pulse followed by a time delay of a few seconds while the relaxation data of different protons in the molecule are collected. This type of procedure enables a spectrum to be acquired every few seconds as opposed to a few minutes required to collect the data using a frequency sweep on a continuous wave instrument. The data from a number of pulses are accumulated using a computer, undergo mathematical manipulation (Fourier transformation) and are combined to produce a spectrum in which the signal to noise characteristics are much improved compared to a spectrum obtained on a single scan continuous wave instrument.

Proton NMR

Chemical shifts

Proton (^1H) NMR is the most commonly used form of NMR because of its sensitivity and the large amount of structural information it yields. The exact absorption or resonance frequency of a proton depends on its environment. For example, a proton attached to carbon atom is affected predominantly by the groups which are separated from the carbon atom to which it is attached by one bond or to a lesser extent two bonds. As discussed earlier, the chemical shift of a proton is determined in relation to the protons of tetramethylsilane, which are arbitrarily assigned a shift of 0 ppm. Shift values for individual protons in a molecule are expressed in ppm and the value of 1 ppm in Hertz depends on the strength of the applied magnetic field which determines the energy required to excite a proton. For example, at a field strength 100 MHz a shift of 1 ppm = 100 Hz. Proton shifts in organic compounds range from slightly below 0 ppm to 14 ppm, i.e. from a δ value of slightly less than 0 to a δ value of 14.

The chemical shift is determined by the extent to which a proton is deshielded by the groups to which it is attached. The more a proton is shielded by the electron density around it, the lower its δ value. If a proton is attached to a system that withdraws electrons from its environment such as an electronegative group or to a group which affects its environment by creating a field opposing the applied

magnetic field, such as occurs in the case of protons attached to an aromatic ring, its δ value will increase, i.e. it will resonate at lower field (lower frequency).

Note:

- (i) Alkyl protons such as those in CH_3 and CH_2 groups not attached to adjacent electronegative groups resonate between δ 0.2–2 ppm.
- (ii) Protons on CH_3 , CH_2 and CH groups attached to electronegative atoms or groups such as O, N, F, Cl, CN, C=C and C=O resonate between δ 2–5.
- (iii) Protons attached directly to C=C resonate between δ 4–7.
- (iv) Protons attached to aromatic rings resonate between δ 6–9. Tables 8.1 and 8.2 show δ values in ppm for protons attached to some common organic groups.

If the NMR spectrum of methylacetate is examined, (Figure 8.4) it can be seen to yield two signals of the same size at δ 2.06 and δ 3.67 more or less as predicted for CH_3CO and CH_3OCO groups according to the values in Table 8.1.

Self-test 8.1

Determine the frequency difference between the shifts of the protons of the methyl groups of methyl acetate in Hz at field strengths of 60 MHz, 250 MHz and 400 MHz.

δ 2.06 δ 3.67
 $\text{CH}_3\text{COOCH}_3$
 Methyl acetate

Answers: 96.6 Hz; 402.5 Hz; 644 Hz

Table 8.1 Approximate chemical shift values for non-aromatic protons attached to carbon

Group	δ ppm	Group	δ ppm	Group	δ ppm
$\text{CH}_3\text{-C}$	0.9	$\text{R-CH}_2\text{-C}$	1.4	CH-C	1.5
$\text{CH}_3\text{-C-O}$	1.3	$\text{R-CH}_2\text{-C-N}$	1.4	CH-C-O	2.0
$\text{CH}_3\text{-C=C}$	1.6	$\text{R-CH}_2\text{-C-O}$	1.9	CH-CO-N	2.4
$\text{CH}_3\text{-CO}$	2.0	$\text{R-CH}_2\text{-CO-N}$	2.2	CH-CO	2.7
$\text{CH}_3\text{-CO-N}$	2.0	$\text{R-CH}_2\text{-C=C}$	2.3	CH-N	2.8
$\text{CH}_3\text{-N}$	2.4	$\text{R-CH}_2\text{-CO}$	2.4	CH-Ar	3.3
$\text{CH}_3\text{-Ar}$	2.3	$\text{R-CH}_2\text{-N}$	2.5	CH-O	3.9
$\text{CH}_3\text{-O}$	3.3	$\text{R-CH}_2\text{-Ar}$	2.9	CH-N-CO	4.0
$\text{CH}_3\text{N}^+(\text{R})_3$	3.3	$\text{R-CH}_2\text{-O}$	3.6	CH-Cl	4.2
$\text{CH}_3\text{-O-CO}$	3.7	$\text{R-CH}_2\text{-O-CO}$	4.1	R-CH=C	4.5–6.0

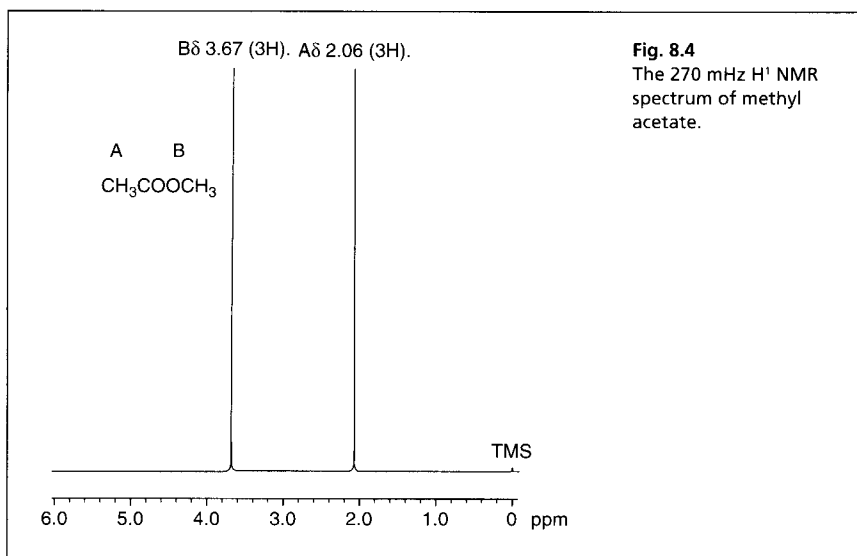
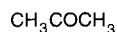

Fig. 8.4
The 270 MHz ^1H NMR spectrum of methyl acetate.

Self-test 8.2

Predict the approximate shifts in ppm of the CH₃ and CH₂ groups in the following molecules and the number of protons producing the signal at each shift:



Acetone

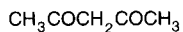

Acetylacetone

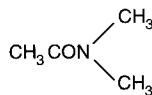

Dimethylamine acetamide

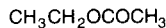

Ethyl acetate

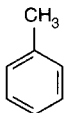

Toluene

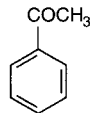

Acetophenone

Answers: acetone δ 2.0 6H; acetylacetone δ 2.0 6H, δ 2.4 2H; dimethylamine acetamide δ 2.0 3H, δ 2.4 6H; ethylacetate δ 1.3 3H, δ 2.0 3H, δ 4.1 2H; toluene δ 2.3 3H; acetophenone 2.6 3H

Table 8.2 Chemical shift values for protons attached to an aromatic ring. The effects of the substituents are either added to or subtracted from the chemical shift for benzene at $\delta = 7.27$

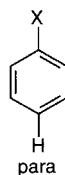
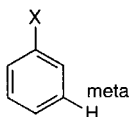
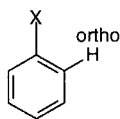

Substituent X	H ortho	H meta	H para
NO ₂	0.94	0.18	0.39
OH	-0.49	-0.13	-0.20
NH ₂	-0.76	-0.25	-0.63
Cl	0.01	-0.06	-0.08
COOH	0.80	0.16	0.25
NH ₃ ⁺	0.40	0.20	0.20
CH ₃	-0.16	-0.09	-0.17
OR	-0.46	-0.1	-0.46
CH ₃ -CO-NH	-0.12	-0.07	-0.21
COOR	0.71	0.1	0.21

Calculation example 8.1

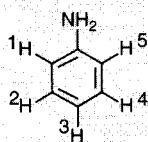

Aniline

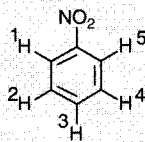

Nitrobenzene

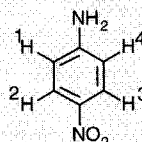

Nitroaniline

Aniline: In aniline the 1 and 5 and 2 and 4 protons are equivalent:

H-1 and H-5 shift = $7.27 - 0.76 = 6.51$ ppm.

H-2 and H-4 shift = $7.27 - 0.25 = 7.02$ ppm.

H-3 shift = $7.27 - 0.63 = 6.64$ ppm.

Thus the spectrum of aniline would contain:

2H 6.51 ppm; 2H 7.02 ppm and 1H 6.64 ppm.

Nitrobenzene: In nitrobenzene the 1 and 5 and 2 and 4 protons are equivalent.

H-1 and H-5 shift = $7.27 + 0.94 = 8.21$ ppm.

H-2 and H-4 shift = $7.27 + 0.18 = 7.45$ ppm.

H-3 shift = $7.27 + 0.39 = 7.66$ ppm.

Thus the spectrum of nitrobenzene would contain:

2H 8.21 ppm; 2H 7.45 ppm and 1H 7.66 ppm.

Nitroaniline: In nitroaniline the 1 and 4 and 2 and 3 protons are equivalent.

H-1 and H-4 shift = $7.27 - 0.76 + 0.18 = 6.69$ ppm.

H-2 and H-3 shift = $7.27 - 0.25 + 0.94 = 7.96$ ppm.

Thus the spectrum of nitroaniline would contain:

2H 6.69 ppm and 2H 7.96 ppm.

Self-test 8.3

Determine the shifts of the protons in the following molecules:

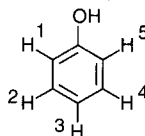

Phenol

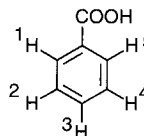

Benzoic acid

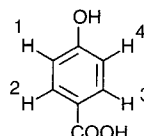

p-hydroxybenzoic acid

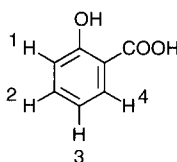

o-hydroxybenzoic acid

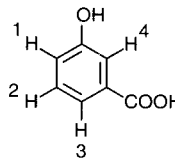

m-hydroxybenzoic acid

Answers: Phenol H1 and H5 at 7.14, H2, H4 at 7.14, H3 at 7.07; benzoic acid H1 and H5 at 8.07, H2 and H4 at 7.43, H3 at 7.52; *p*-hydroxybenzoic acid H1 and H4 at 6.94, H2 and H3 at 7.94; *o*-hydroxybenzoic acid H1 at 6.94, H2 at 7.39, H3 at 7.23, H4 at 7.94; *m*-hydroxybenzoic acid H1 at 7.03, H2 at 7.30, H3 at 7.87, H4 at 7.58

Spin spin coupling

In some of the molecules considered above we have neglected an additional shift effect which is caused by the spin of the protons on the atoms next to a particular proton. In examining the proton NMR spectrum of ethyl acetate (Fig. 8.5), it can be seen that its spectrum is more complicated than that of methyl acetate and that the signal due to the CH₃ group B in the alcohol part of the ester is now three lines instead of one, the middle line of the three corresponding to the chemical shift

estimated from Table 8.1. The protons of the adjacent CH_2 group C can align their spins in three different ways relative to the CH_3 as seen in Figure 8.6. For alignment 1 there are two equivalent alignments where the effects of the adjacent protons cancel each other out and do not perturb the signal of the methyl group from its predicted shift (*ca* 1.30 ppm). This produces a central line which is twice the height/area of the two lines produced by alignments 2 and 3. The CH_2 group itself is also split by the effect of the adjacent methyl group. In this case statistical analysis of the possible combination of the spins of the adjacent methyl protons indicates that the signal of the CH_2 protons should be a quartet with the lines in the quartet being in the ratio 1:3:3:1; the mid-point between the two central lines gives the predicted chemical shift of 4.1 ppm. The methyl group A appears, as it does in methyl acetate, as a singlet since it is isolated from any adjacent protons. The effect of adjacent protons on the signal for a given group is known as coupling and coupling constants are given in Hz; the range of coupling constants between adjacent protons is 0–20 Hz. When two protons are close in chemical shift, coupling can cause their signals to overlap. The coupling constant is independent of the applied magnetic field and thus the size of coupling constants in ppm will decrease with increasing field strength although their values in Hz remain the same. The higher the field strength the less likely it is that signals from individual protons will overlap.

The spectrum in Figure 8.5 was obtained on a 270 MHz (1 ppm = 270 Hz) instrument. The shifts in ppm obtained for the three lines in the CH_3 group signal are: 1.235, 1.262 and 1.289. Therefore these lines are evenly spaced 0.027 ppm apart, which is equivalent to $270 \times 0.027 \text{ Hz} = 7.29 \text{ Hz}$. Figure 8.7 shows the spectrum of ethyl acetate obtained on a 60 MHz (1 ppm = 60 Hz) instrument; in this case the coupling constants are large (*ca* 0.1 ppm) relative to the ppm scale but have a similar coupling constant of *ca* 7 Hz to that observed using the 270 MHz instrument.

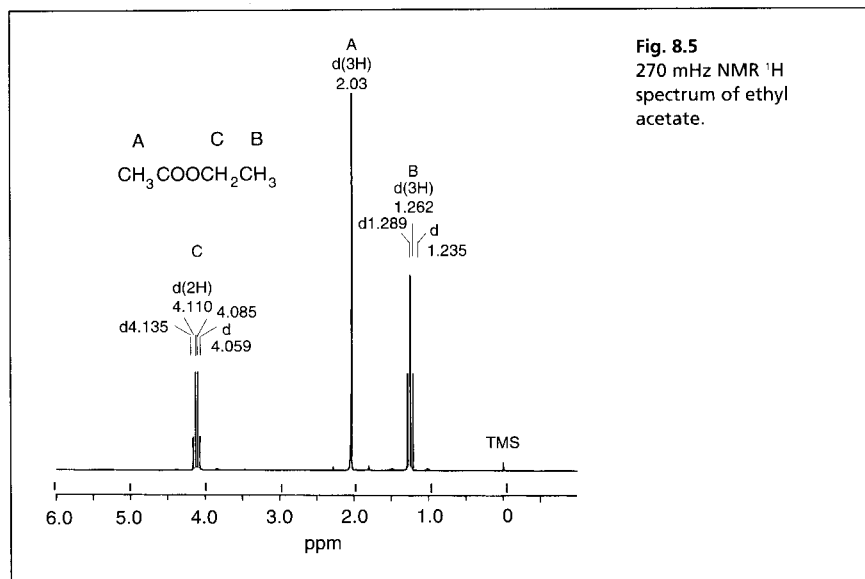
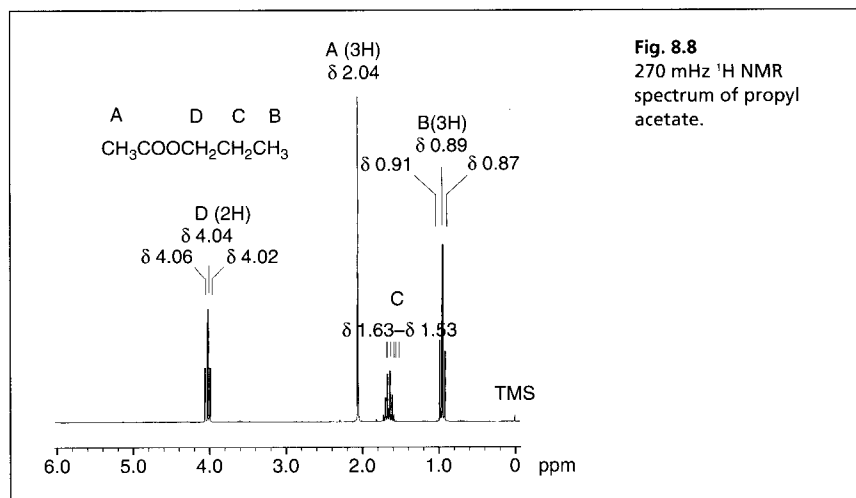
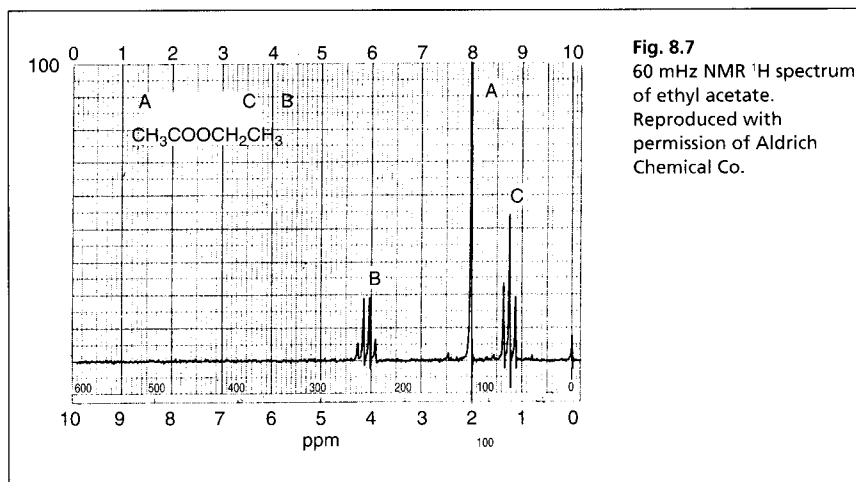
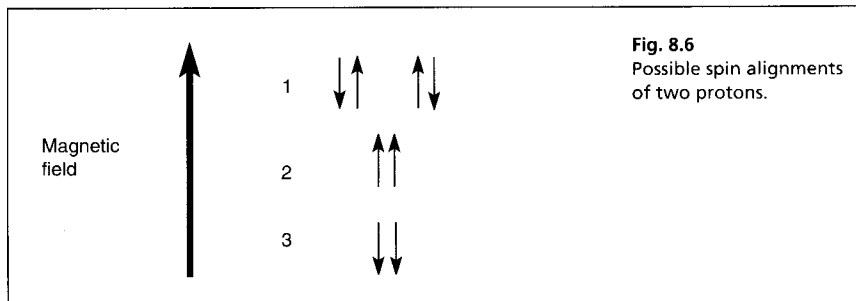
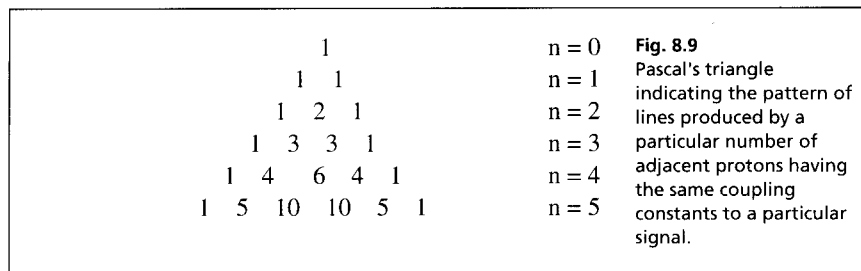

Fig. 8.5
270 MHz NMR ^1H
spectrum of ethyl
acetate.

As the number of adjacent protons in a molecule increases, the splitting pattern of the protons increases in complexity. Figure 8.8 shows the proton NMR spectrum of propyl acetate. In this case the CH_3 group B is present as a triplet as in ethyl acetate, but the CH_2 group C now has six lines due to the presence of five adjacent protons – three on group A and two on group D. The ratio of the lines in this case is 1:5:10:10:5:1.



The number of lines expected and their relative intensities can be obtained from Pascal's triangle shown in Figure 8.9.



If the protons of groups B and D in propyl acetate did not have similar coupling constants with the protons on group C a more complicated pattern of lines would result as indicated in Figure 8.10. In the case shown in Figure 8.10A, the protons can be viewed as being split into four lines by an adjacent methyl group and each of the four lines are further split into three lines by a CH_2 group giving a total of 12 lines (a quartet of triplets). If the coupling constants to adjacent protons are not widely different the patterns tend to merge into those that would be expected if all the adjacent protons coupled identically as in the case of propyl acetate, where coupling to five adjacent protons on two carbons produces six lines.

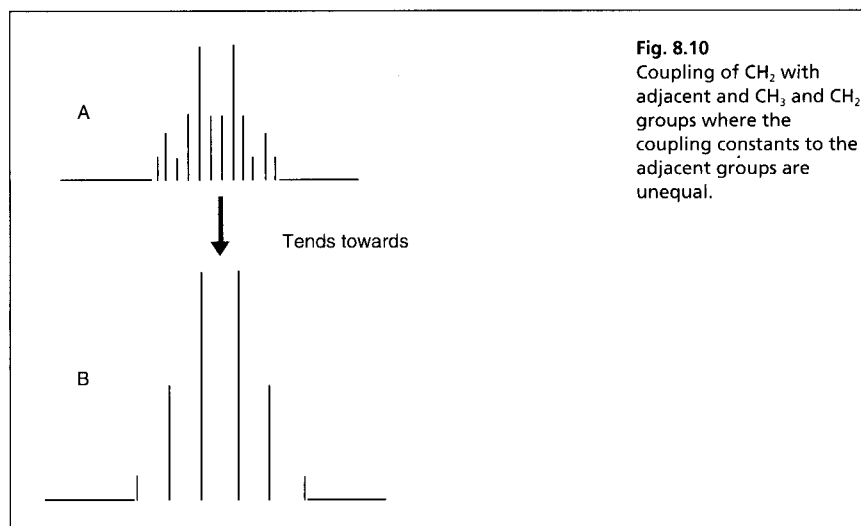

As indicated in Figure 8.10 splitting patterns can be complex but the NMR spectra of many drug molecules do not reach this level of complexity. Some classes of molecules such as the steroids or prostaglandins provide examples of spectra where complex splitting patterns occur but the majority of drug molecules contain one or two aromatic rings with varying types of relatively simple side chain. In the case of complex molecules such as steroids, two-dimensional NMR techniques involving proton-proton and proton-carbon correlations have simplified spectral interpretation. The most complex applications of NMR are found in the structure elucidation of natural products.

Application of NMR to structure confirmation in some drug molecules

Proton NMR spectrum of paracetamol

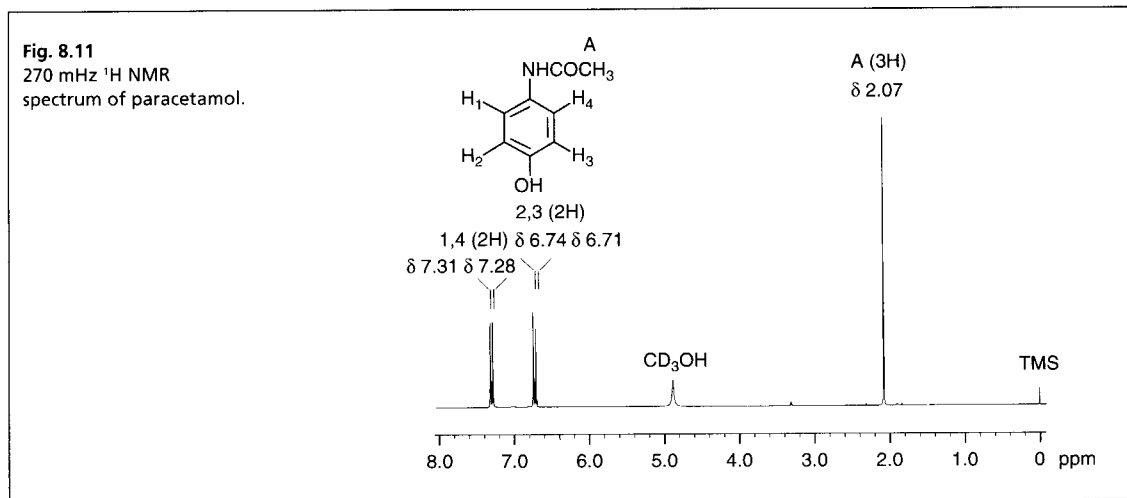

The NMR spectrum of paracetamol run in CD₃OD is shown in Figure 8.11. The spectrum shows a signal for an isolated CH₃ group at δ 2.07 ppm due to CH₃CONH. The broad signal at δ 4.88 is due to the proton in CD₃OH, which forms as a result of exchange of deuterium with the NH and OH protons of paracetamol, this is why the protons attached to these groups are not seen in the spectrum. The other signals in the spectrum are two doublets with mean shifts of δ 6.72 ppm and δ 7.30, which from the information given in Table 8.2 can be said to be assigned to the equivalent protons 2 and 3 and 1 and 4, respectively. Proton 1 is coupled to proton 2 and proton 4 is coupled to proton 3, thus causing the signals to appear as doublets.

Proton NMR spectrum of aspirin

Figure 8.12 shows the proton NMR spectrum for aspirin run in CD₃OD. The methyl group is isolated and appears at δ 2.28, which could be predicted from Table 8.1. There is a broad peak at δ 4.91 due to CD₃OH formed by exchange with the -COOH group on aspirin. The aromatic region is more complex than that observed for paracetamol because the four aromatic protons are non-equivalent. The four proton signals have mean shifts of 7.13 ppm, 7.34 ppm, 7.60 ppm and 8.02 ppm and from Table 8.2 it is possible to assign these signals to protons 4, 2, 3 and 1 respectively. H-1 is a doublet due to coupling to H-2; H-2 appears as a triplet due to overlap of two doublets caused by coupling to H-1 and H-3. Similarly, H-3 is a triplet due to coupling equally with H-2 and H-4, and H-4 is a doublet due to coupling with H-3. It is actually possible with a closer view to see additional splitting of all of the aromatic proton signals and this is due to long-range coupling between the protons meta to each other, i.e. H-1 and H3 and H2 and H4, which can occur in aromatic systems and can be up to 3 Hz. Para coupling can also occur but it is only *ca* 1 Hz.

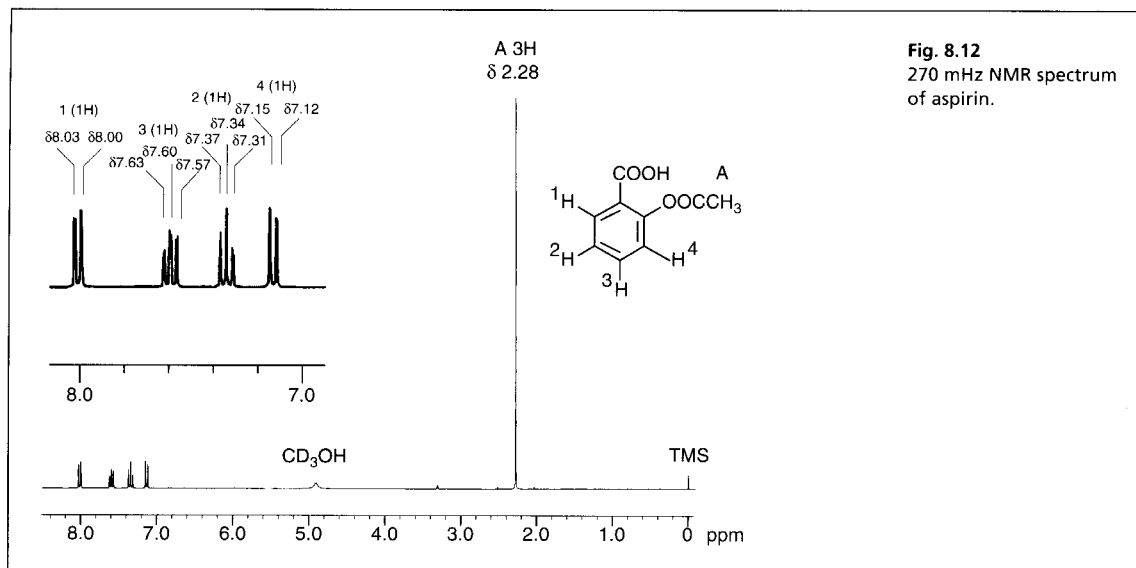

Proton NMR spectrum of salbutamol: A more complex example

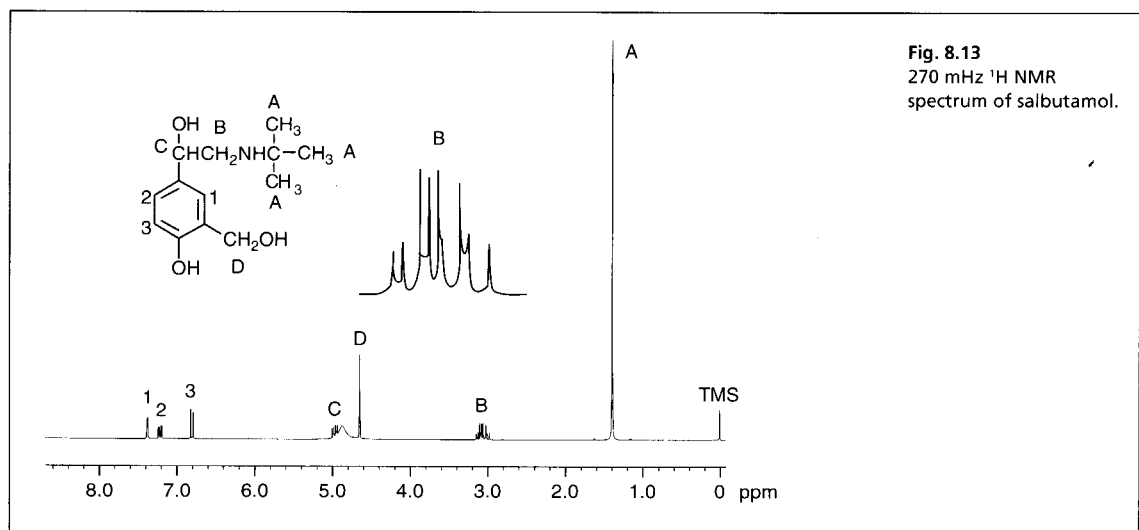

Figure 8.13 shows the NMR spectrum of salbutamol obtained in CD_3OD and in this case the spectrum is somewhat more complex. The signal at δ 1.40 arises from the t-butyl group A in which the CH_3 groups are all equivalent and have no adjacent protons to which they could couple. The signal at δ 4.65 is due to the CH_2 group D, which is also not coupled to any other protons. The protons on the aromatic ring are also readily assigned: the doublet at δ 6.80 is due to H-3, which is coupled to H-2. H-2 appears at δ 7.22 and is split into a doublet via coupling to H-3 and each peak in

the doublet is split again through meta-coupling to H-1, which appears at δ 7.37 and is split into a closely spaced doublet through meta-coupling to H-2. A signal centred at δ 4.97, appearing on the shoulder of a broad peak due to CD₃OH, is due to proton C. This proton is attached to a chiral centre and is coupled to the two adjacent protons B1 and B2, which are non-equivalent since they are immediately next to a chiral centre. Thus proton C has two different coupling constants to protons B1 and B2, and appears as a doublet of doublets. The most complex signal in the spectrum is due to protons B1 and B2 and this requires more detailed explanation. These protons produce what is known as an 'AB type signal' where, because the protons are close in chemical shift (less than 30 Hz apart), they give lines which are of unequal sizes as shown in Figure 8.14.

The NMR spectrum is perturbed in an AB system so that the ratio of line intensities composing the doublet instead of being 1:1 are given by:

$$\text{Line ratio} = \frac{\nu_2 - \nu_3}{\nu_1 - \nu_4}$$

where the difference between ν_1 and ν_4 is 30 Hz and the difference between ν_2 and ν_3 is 10 Hz, the line ratio of the outer to inner lines will be 1:3. The smaller the difference in shift in Hz between the inner A and B lines the smaller will be the satellite peaks.

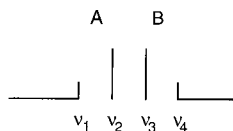

Fig. 8.14
Line intensities in AB systems.

The place to start with the analysis of the signal for the B protons in salbutamol is with signal C, which gives the couplings of the B1 and B2 protons with the proton on position C. From analysis of this signal the two couplings are 4 and 10 Hz. The total width of the B signal is 44 Hz, thus its width in the absence of coupling to the C proton would be 37 Hz (see Fig. 8.15 for clarification). To make the full analysis one has to try some values for the AB coupling that make approximate sense in relation to the final signal. If the coupling of the B protons to each other is 12 Hz, then the pattern when plotted on graph paper (Fig. 8.15) gives more or less the pattern seen for the B protons in salbutamol (leaving 13 Hz from the total signal width for separation of the inner lines). Two other points should be noted: the ratio of the outer to the inner lines is *ca* 1:3 as predicted from the equation shown in Figure 8.14 and the original separation of the B1 and B2 signals is given by the following equation:

$$\delta_{B1} - \delta_{B2} = \sqrt{(\nu_4 - \nu_1)(\nu_3 - \nu_2)}$$

If the differences between the frequencies are substituted in the equation this gives a difference in frequency of B1 and B2 of 22 Hz, i.e. the germinal coupling (coupling of protons on the same carbon) of the two signals gives shifts of 7.5 Hz in one direction and 4.5 Hz in the other direction instead of the usual even splitting.

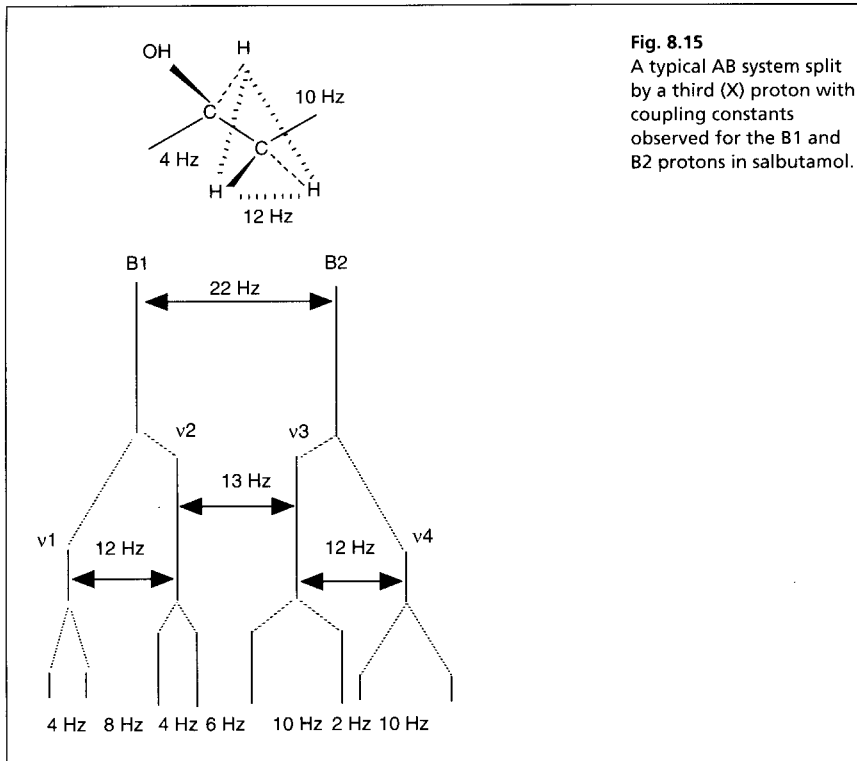
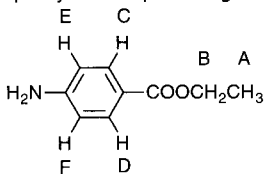

Fig. 8.15
A typical AB system split by a third (X) proton with coupling constants observed for the B1 and B2 protons in salbutamol.

Self-test 8.4

Using the values given in Tables 8.1 and 8.2 predict the approximate NMR spectra of the following drug molecules with respect to chemical shift, the number of protons in each signal and the multiplicity of their proton signals.



Benzocaine

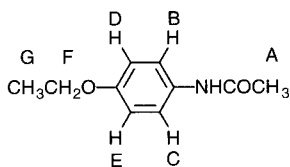

Phenacetin

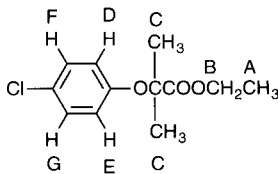

Clofibrate

Answers: Benzocaine: δ 1.3, 3H, triplet (A); δ 4.1, 2H, quartet (B); δ 7.73, 2H, doublet (C,D); δ 6.61, 2H, doublet (E,F); δ 6.1, 2H, doublet (E,F); Phenacetin: δ 1.3, 3H, triplet (G); δ 2.0, 3H, singlet (A); δ 4.1, 2H, quartet (F); δ 6.74, 2H, doublet (D,E); δ 7.05, 2H, doublet (B,C); Clofibrate: δ 1.3, 3H, triplet (A); δ 1.3, 6H, singlet (C); δ 4.1, 2H, quartet (B); δ 7.18, 2H, doublet (F,G); δ 6.75, 2H, doublet (D,E).

Very small couplings might also be observed for aromatic protons para to each other.

Self-test 8.5

Use graph paper to determine the coupling constants experienced by lines for protons A and B shown below, which are coupled to each other and to a third proton and determine the separation of the A and B signals.

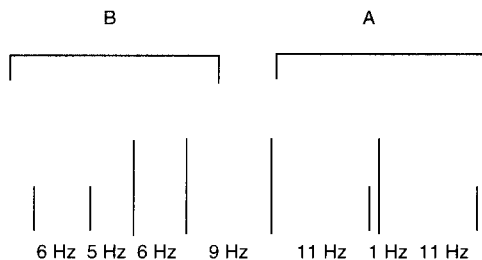

Answer: on page 165

Self-test 8.6

Assign the protons in the ^1H NMR spectrum of phenylephrine. (Note: protons B and C are non-equivalent since they are next to an asymmetric centre).

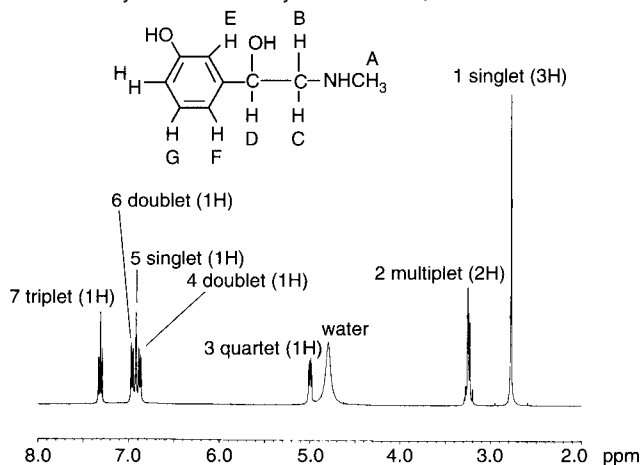

Answer: Signal 1A; signal 2B + C compare with salbutamol (in this case the B and C protons are much closer in shift); signal 3D; signal 4H; signal 5E; signal 6F; signal 7G, which has identical couplings to protons H and F.

Carbon-13 NMR

Chemical shifts

Nuclei other than ^1H give nuclear magnetic resonance spectra. One of the most useful is ^{13}C but since the natural abundance of ^{13}C is only 1.1% of that of ^{12}C , the ^{13}C resonance is relatively weak. ^{13}C resonance occurs at a frequency *ca* 25.1 MHz when proton resonance is occurring *ca* 100 MHz (i.e. at 2.33 Tesla). Thus it is at lower energy than proton resonance and the spread of resonances for ^{13}C is over *ca* 180 ppm, thus there is less likelihood of overlapping lines in ^{13}C NMR. Table 8.3 shows the chemical shifts of some ^{13}C signals. It is possible to calculate these quite precisely¹ and the following table is only an approximate guide. A ^{13}C atom will

couple to any protons attached to it, e.g. a carbon with one proton attached will appear a doublet, to get the most information from the weak carbon spectrum it is better if this coupling is removed. In the salbutamol example the coupling is removed using the J mod technique.

Table 8.3 Typical chemical shifts of ^{13}C atoms

Group	δ ppm	Group	δ ppm	Group	δ ppm
$\text{H}_3\text{C}^{13}\text{-C}$	5–20	$\text{C-H}_2\text{C}^{13}\text{-N}$	35–65	$(\text{C})_3\text{C}^{13}\text{-C-N}$	50–70
$\text{H}_3\text{C}^{13}\text{-C=C}$	15–30	$\text{C-H}_2\text{C}^{13}\text{-O}$	55–75	$(\text{C})_3\text{C}^{13}\text{-C-O}$	70–90
$\text{H}_3\text{C}^{13}\text{-Ar}$	ca 20	$(\text{C})_2\text{HC}^{13}\text{-C}$	25–55		
$\text{H}_3\text{C}^{13}\text{-COO}$	ca 20	$(\text{C})_2\text{HC}^{13}\text{-CO}$	40–70	ArC^{13}H	115–135
$\text{H}_3\text{C}^{13}\text{-CO}$	22–32	$(\text{C})_2\text{HC}^{13}\text{-Ar}$	ca 40	$\text{ArC}^{13}\text{-C}$	137–147
$\text{H}_3\text{C}^{13}\text{-N}$	25–40	$(\text{C})(\text{O})\text{HC}^{13}\text{-Ar}$	70–80	$\text{ArC}^{13}\text{-Cl}$	135
$\text{H}_3\text{C}^{13}\text{-O}$	45–55	$(\text{C})_2\text{HC}^{13}\text{-N}$	45–75	ArC^{13}CO	137
$\text{C-H}_2\text{C}^{13}\text{-C}$	16–46	$(\text{C})_2\text{HC}^{13}\text{-O}$	65–85	$\text{ArC}^{13}\text{-N}$	145–155
$\text{C-H}_2\text{C}^{13}\text{-CO}$	30–50	$(\text{C})_3\text{C}^{13}\text{-C}$	35–55	$\text{ArC}^{13}\text{-O}$	150–160
$\text{C-H}_2\text{C}^{13}\text{-Ar}$	ca 30	$(\text{C})_3\text{C}^{13}\text{-C-CO}$	45–65	$\text{C}^{13}=\text{O}$	170–200
$\text{O-H}_2\text{C}^{13}\text{-Ar}$	60–70	$(\text{C})_3\text{C}^{13}\text{-C-Ar}$	45–65		

An example of a ^{13}C spectrum

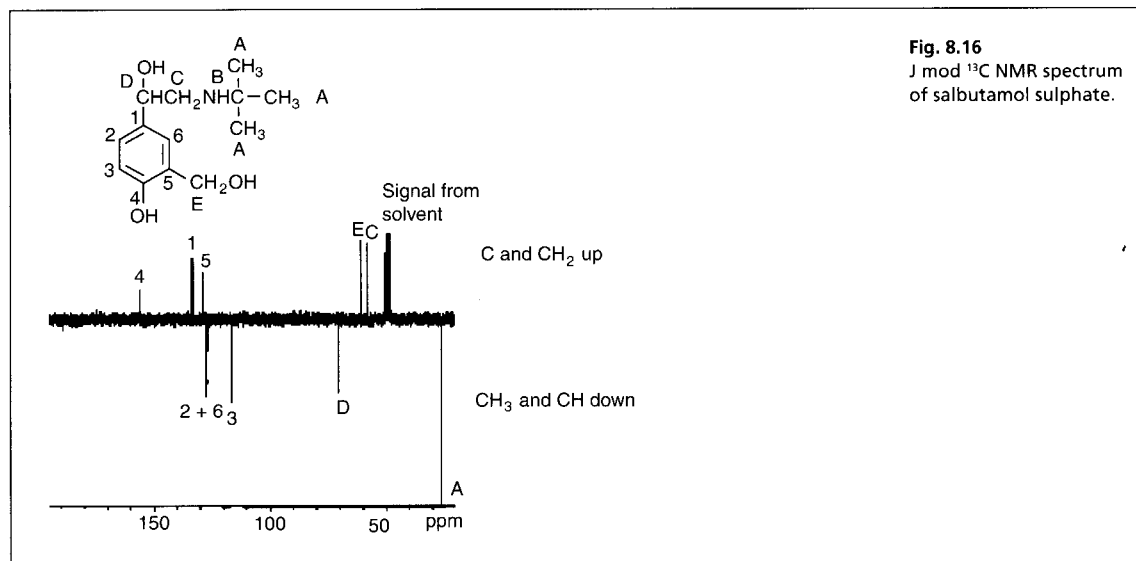
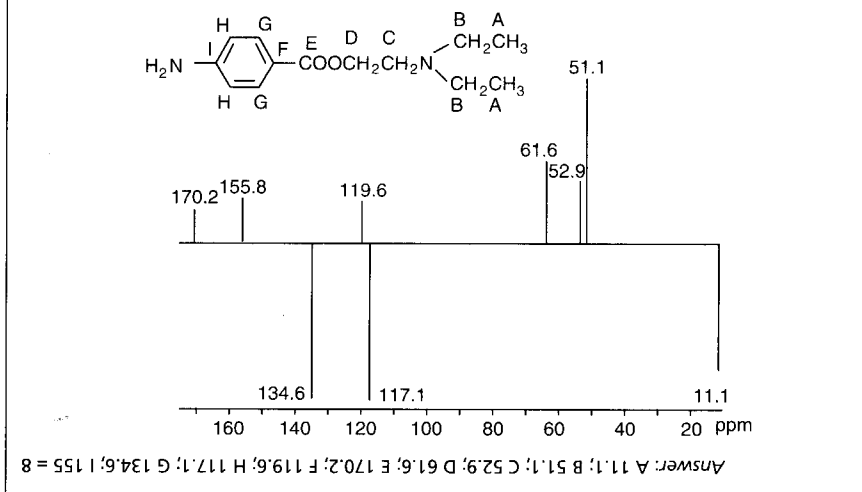

Figure 8.16 shows the J mod spectrum of salbutamol sulphate. As can be seen the J mod ^{13}C spectrum of salbutamol is much simpler than its proton spectrum. The carbons can be assigned as follows: A δ 26; C δ 58.8; E δ 61; D δ 70.4; 3 δ 116; 2 + 6 δ 127.1; 5 δ 129.5; 1 δ 133 and 4 δ 156 (carbons 3 and 5 are shifted upfield through being ortho to an OH group). The signal due to carbon B is missing and this illustrates one of the problems of ^{13}C NMR which is that the relaxation times of the carbon atoms tend to vary more widely than those for protons in ^1H NMR and thus their signals may be missed or not fully accumulated. This is particularly true for quaternary carbons and it can be seen in Figure 8.16 that the quaternary carbons 1, 4 and 5 give weaker signals than the other carbons which have protons attached. In the case of quaternary carbon B, its signal has been completely missed. Thus the signals

in ^{13}C are less quantitative than ^1H NMR signals. A J mod spectrum is one of the modern equivalents of the ^{13}C spectrum; it allows the number of protons attached to the carbon atoms to be known while at the same time removing the signal broadening due to the coupling between ^{13}C and its attached protons.

Self-test 8.7

Assign the signals in the J mod C-13 spectrum of procaine shown below (C and CH_2 up CH_3 and CH down) obtained on a 400 MHz instrument.



Two-dimensional NMR spectra

A simple example

Computer control of NMR instruments has led to great advances in both data acquisition and processing and has given rise to advanced NMR structural elucidation techniques. One of the first of these was two-dimensional

Fig. 8.17
The proton-proton correlation spectrum of the aromatic region of aspirin.

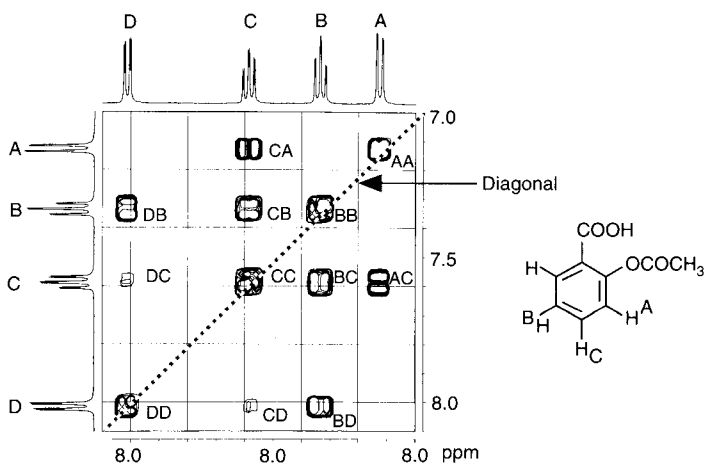

proton–proton correlation or COSEY. This technique enables correlations to be made between protons which are coupled to each other. Taking the simple example of the aromatic proton region of aspirin the correlated spectroscopy COSEY spectrum appears as shown in Figure 8.17, the diagonal gives the correlation of the signals with themselves, i.e. A with A, B with B, etc. On either side of the diagonal identical information is presented, thus only one side of the diagonal is required for spectral interpretation. From the information given in Figure 8.17, it can be seen that A is coupled to C, B is coupled to C and D, and C is weakly coupled to D via long-range meta-coupling. COSEY has simplified interpretation of complex NMR spectra. There are a number of techniques stemming from the basic two-dimensional technique, which for example allow correlation between carbon atoms and the protons attached to them and correlations of carbon atoms with protons one or two bonds removed from them, heteronuclear multiple bond correlation (HMBC).

A more complex example

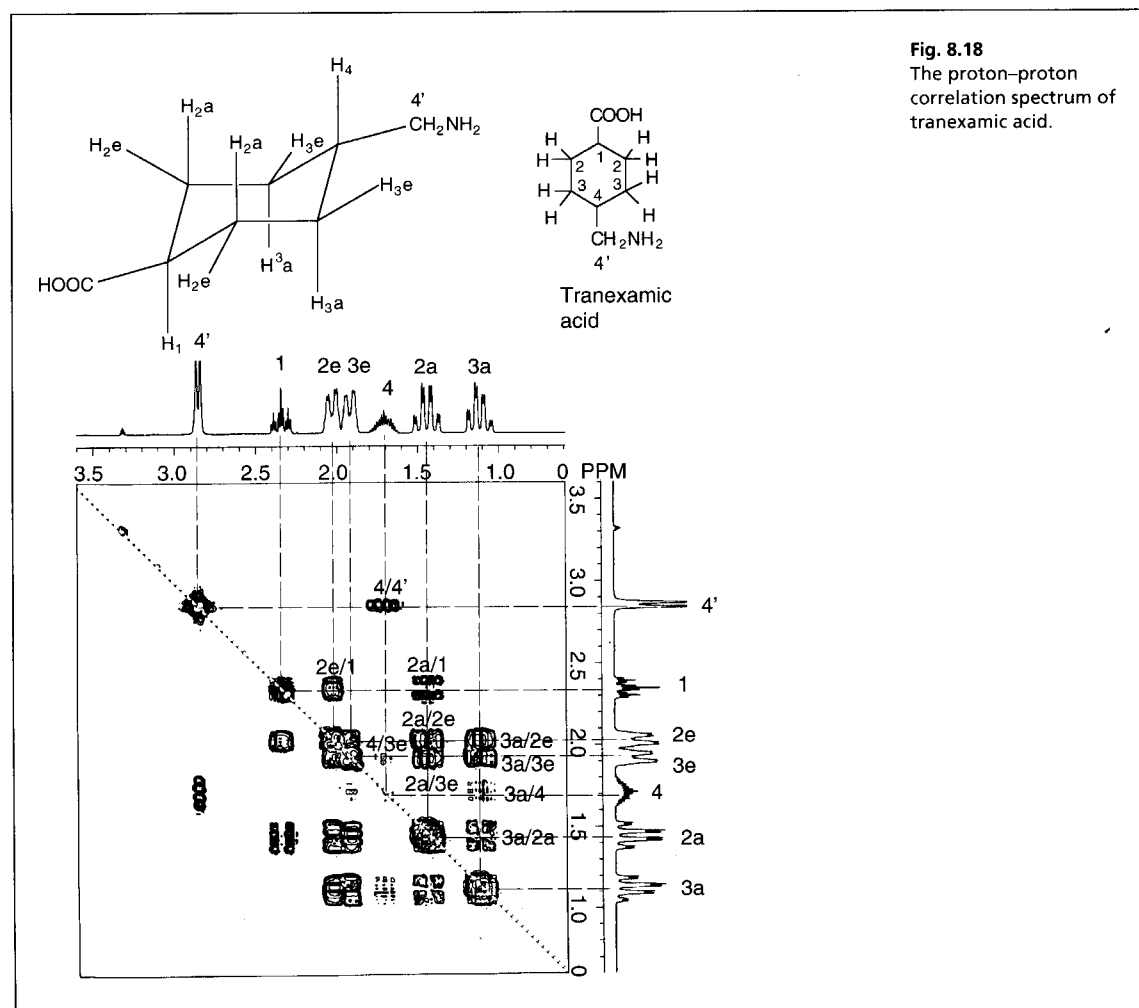

The anti-haemorrhagic drug tranexamic acid when drawn in a two-dimensional representation may look as if all four protons on position 2 and all four protons on position 3 are equivalent. However, when the structure is drawn as indicated on the left in Figure 8.18 it is apparent that, because the molecule is forced for steric reasons to remain with the carboxylic acid and methylamine groups more or less in the plane of the paper, the axial (a) protons, which are held above and below the plane of the paper, and the equatorial (e) protons, which are held more or less in the plane of the paper, are no longer in an equivalent environment. This introduces a number of additional couplings between the protons in the molecule leading to an increased complexity of its spectrum. Assignment of the protons in this spectrum is simplified by two-dimensional NMR and as for the aspirin example the correlations can be derived from the signals either side of the diagonal. The place to start in this type of assignment is usually with the simplest signal, which in this case is due to the 4' protons which only couple to the 4 protons. The 4 protons themselves present the most complex signal since they are separately coupled to the 4', 3a and 3e protons producing $3 \times 3 \times 3 = 27$ lines which are not all seen because of the overlap of the signals. Two additional factors emerge from examination of the signals due to axial and equatorial protons in Figure 8.18 that are applicable to the interpretation of more complex molecules:

- (i) The signals due to 2a and 3a experience three couplings due to coupling to the equatorial protons attached to the same carbon (germinal coupling) and due to coupling (9–13 Hz) to two adjacent axial protons resulting overall in broad signals. The signals due to 2e and 3e protons are narrower since they only experience one large germinal coupling to the axial proton attached to the same carbon. The axial/ equatorial and equatorial/equatorial couplings (e.g. 2e/3a and 2e/3e) are small (2–5 Hz) resulting in narrower signals overall.
- (ii) Axial protons (2a and 3a) are usually upfield from equatorial protons (2e and 3e) since they are shielded by being close in space to other axial protons.

Application of NMR to quantitative analysis

NMR can be used as a rapid and specific quantitative technique. For example a drug can be rapidly quantified by measuring suitable protons (often isolated methyl protons) against the intense singlet for the methyl groups in t-butanol. The amount of drug present can be calculated using the following formula for the methyl groups in t-butanol used as an internal standard (int. std.):

$$\text{Amt. of drug} = \frac{\text{Area signal for drug protons}}{\text{Area signal for int. std. protons}} \times \text{mass of int. std. added} \times \frac{\text{MW drug}}{\text{MW int.std.}} \times \frac{\text{No. protons from int. std.}}{\text{No. protons from drug}}$$

An advantage of this method of quantitation is that a pure external standard for the drug is not required since the response is purely proportional to the number of protons present and this can be measured against a pure internal standard. Thus the purity of a substance can be determined without a pure standard for it being available. Figure 8.19 shows the spectrum of an extract from tablet powder containing aspirin, paracetamol and codeine with 8 mg of t-butanol added as an internal standard. In the analysis, deuterated methanol containing 8 mg/ml of t-butanol was added to the sample of tablet powder, and the sample was shaken for 5 min, filtered and transferred to an NMR tube. The t-butanol protons gave a signal at δ 1.31, the

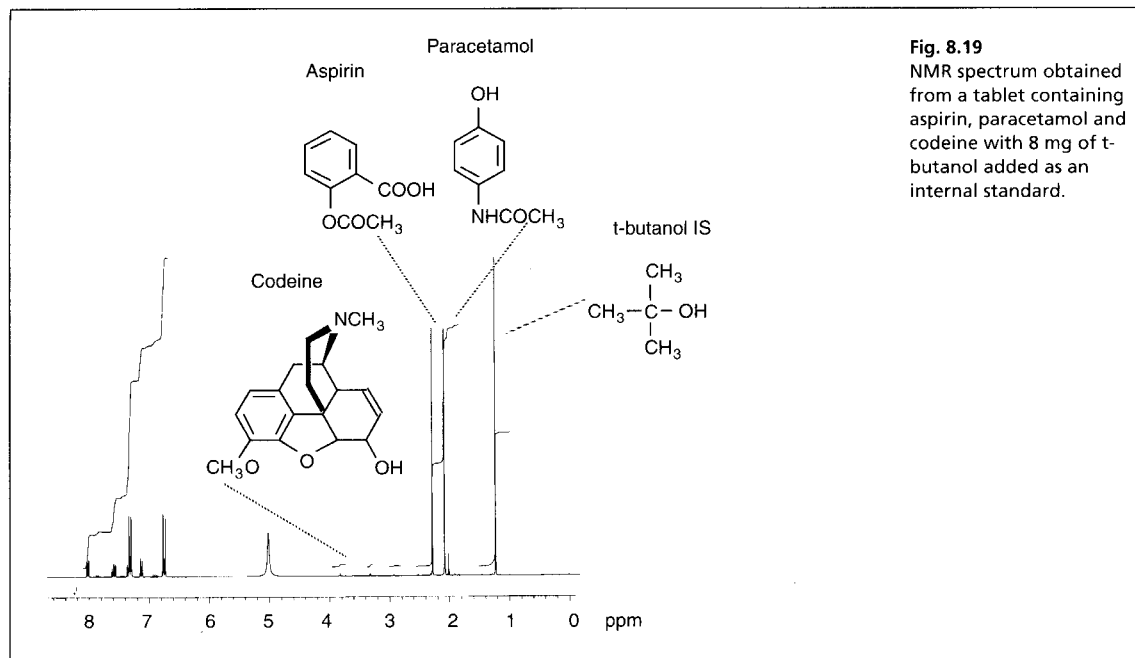

Fig. 8.19
NMR spectrum obtained from a tablet containing aspirin, paracetamol and codeine with 8 mg of t-butanol added as an internal standard.

CH_3CO group in aspirin gave a signal at δ 2.35, the CH_3CON group in paracetamol gave a signal at δ 2.09 and the CH_3O group in codeine gave a signal at δ 3.92. The low amount of codeine present would be likely to make its quantitation inaccurate in the example shown, which was only scanned for a few minutes. Since its signal is close to the baseline, a longer scan would improve the signal:noise ratio giving better quantitative accuracy.

The data obtained from the analysis is as follows:

- Stated content/tablet = aspirin 250 mg, paracetamol 250 mg, codeine phosphate 6.8 mg
- Weight of 1 tablet = 0.6425 g
- Weight of tablet powder taken for analysis = 0.1228 g
- Weight of t-butanol internal standard added = 8.0 mg
- Area of internal standard peak = 7.2
- Area of aspirin CH_3 peak = 5.65
- Area of paracetamol CH_3 peak = 6.73
- Codeine phosphate CH_3 peak = 0.115
- MW t-butanol = 74.1
- MW aspirin = 180.2
- MW paracetamol = 151.2
- MW codeine phosphate = 397.4
- Number of protons in t-butyl group = 9
- Number of protons in methyl groups of aspirin, paracetamol and codeine = 3.

Calculation of the paracetamol in the tablets is shown in Example 8.2.

Other specialised applications of NMR

There are a number of other specialised applications of NMR which are valuable in

Calculation example 8.2

Weight of aspirin and paracetamol expected in the tablet powder = $250 \times \frac{0.1228}{0.6425} = 47.97 \text{ mg}$

Weight of codeine expected in the tablet powder = $6.8 \times \frac{0.1228}{0.6425} = 1.300 \text{ mg}$

Calculation for aspirin

Substituting into the formula given above:

mg of aspirin present in extract = $\frac{5.65}{7.2} \times 8 \times \frac{180.2}{74.1} \times \frac{9}{3} = 45.80 \text{ mg}$

Percentage of stated content = $\frac{45.8}{47.97} \times 100 = 95.48\%$

Self-test 8.8

From the above data calculate the percentage of stated content for paracetamol and codeine phosphate.

Answers: paracetamol 95.42%, codeine phosphate 158.5%

pharmaceutical development. Chiral NMR employs chiral shift reagents, e.g. europium tris(d,d-dicamphoyl)methanate), which can be used to separate signals from enantiomers in a mixture and thus quantify them. Solid state NMR can be used to examine crystalline structures and characterise polymorphs and crystal hydrates. Biological NMR uses wide bore sample tubes and can be used to examine drugs and their metabolites directly in biological fluids such as urine or cerebrospinal fluid. High-pressure liquid chromatography (HPLC) NMR is currently under development so that impurities or drug metabolites can be chromatographically separated by HPLC and identified by using an NMR spectrometer as a detector.

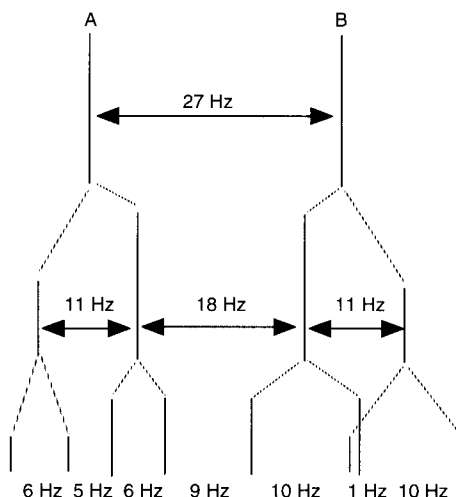
Answer to Self-test 8.5

References

1. D.H. Williams and I. Fleming. Spectroscopic methods in organic chemistry, 5th Edn. McGraw-Hill Book Co., London (1996).
2. Methods for Structure Elucidation by High-Resolution NMR. G. Batta, K. Kover and C. Szantay, eds. Elsevier, Amsterdam (1997).

Further reading

Basic One- and Two-Dimensional NMR Techniques. H. Frebolin, ed. Wiley Interscience, Chichester (1993).

9

Mass spectrometry

Keypoints

Introduction

Instrumentation

- Magnetic sector instruments
- Quadrupole instruments

Mass spectra obtained under electron impact (EI) ionisation conditions

Molecular fragmentation patterns

- Homolytic and heterolytic α -cleavage
- Cleavage with proton transfer
- Fragmentation of ring structures

EI mass spectra of some drug molecules

- Examples where the molecular ion is abundant
- Drug molecules in which homolytic α -cleavage dominates the spectrum
- Isotope peaks
- Tropylium ion
- McLafferty rearrangement

Gas chromatography–mass spectrometry (GC–MS)

- Ionisation techniques used in GC–MS
- Electron impact
- Positive ion chemical ionisation

Negative ion chemical ionisation

Applications of GC–MS to impurity profiling

Liquid chromatography–mass spectrometry (LC–MS)

Applications of LC–MS in pharmaceutical analysis

- Determination of impurities in insulin-like growth factor with electrospray–mass spectrometry (ES–MS)
- Characterisation of a degradant of famotidine
- Profiling impurities and degradants in butorphanol tartrate

KEYPOINTS

Principles

- Charged molecules or molecular fragments are generated in a high vacuum region or, immediately prior to a sample entering a high vacuum region, using a variety of methods for ion production. The ions are generated in the gas phase so that they can then be manipulated by the application of either electric or magnetic fields to enable the determination of their molecular weights.

Applications

- Mass spectrometry provides a highly specific method for determining or confirming the identity or structure of drugs and raw materials used in their manufacture.
- Mass spectrometry in conjunction with either gas chromatography (GC–MS) or liquid chromatography (LC–MS) provides a method for characterising impurities in drugs and formulation excipients.
- GC–MS and LC–MS provide highly sensitive and specific methods for determining drugs and their metabolites in biological fluids and tissues.

Strengths

- The best method for getting rapid identification of trace impurities, which should ideally be carried out using chromatographic separation in conjunction with high resolution mass spectrometry so that elemental compositions can be determined
- With the advent of electrospray mass spectrometry and the re-emergence of time of flight mass spectrometry, the technique will be of major use in the quality control of therapeutic antibodies and peptides.

Limitations

- Mass spectrometry is not currently used in routine quality control (QC) but is placed in a research and development (R & D) environment where it is used to solve specific problems arising from routine processes or in process development
- The instrumentation is expensive and requires support by highly trained personnel and regular maintenance. However, these limitations are gradually being removed.

Introduction

A mass spectrometer works by generating charged molecules or molecular fragments either in a high vacuum or immediately prior to the sample entering the high vacuum region. The ionised molecules have to be generated in the gas phase. In classical mass spectrometry there was only one method of producing the charged molecules but now there are quite a number of alternatives. Once the molecules are charged and in the gas phase they can be manipulated by the application of either electric or magnetic fields to enable the determination of their molecular weight and the molecular weight of any fragments which are produced by the molecule breaking up.

Instrumentation

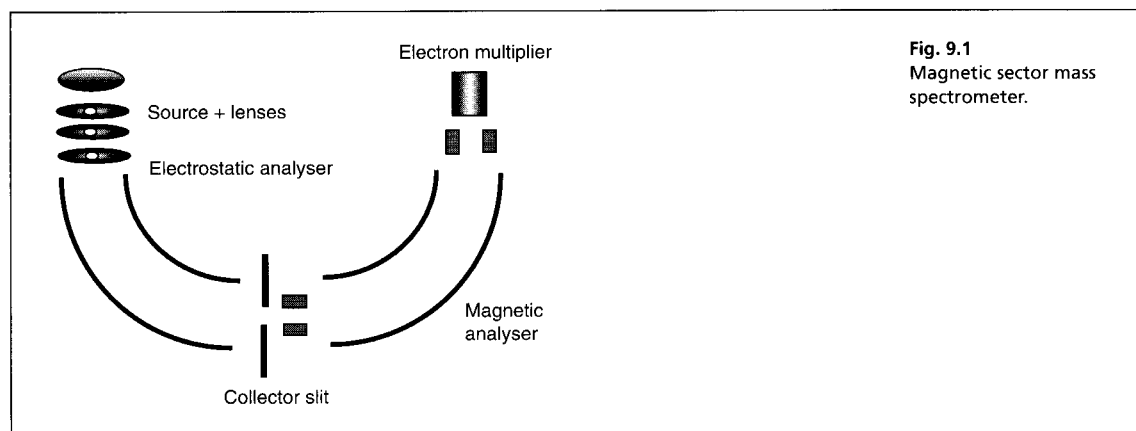
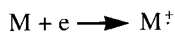

Fig. 9.1
Magnetic sector mass spectrometer.

A schematic view of a magnetic mass spectrometer is shown in Figure 9.1.

- The sample is introduced into the instrument source by heating it on the end of a probe until it evaporates, assisted by the high vacuum within the instrument.
- Once in the vapour phase, the analyte is bombarded with the electrons produced by a rhenium or tungsten filament, which are accelerated towards a positive target with an energy of 70 eV. The analyte is introduced between the filament and the target, and the electrons cause ionisation as follows:



- (iii) Since the electrons used are of much higher energy than the strength of the bonds within the analyte (4–7eV) extensive fragmentation of the analyte usually occurs.
- (iv) Two types of system are commonly used to separate ions on the basis of their charge to mass ratio.

Magnetic sector instruments

In a magnetic sector instrument the ions generated are pushed out of the source by a repeller potential of same charge as the ion itself, and are then accelerated in an electric field of *ca* 3–8 kV and travel through an electrostatic field region so that they are forced to fall into a narrow range of kinetic energies prior to entering the field of a circular magnet. They then adopt a flight path through the magnetic field depending on their charge to mass (m/z) ratio; the large ions are deflected less by the magnetic field:

$$m/z = \frac{H^2 r^2}{2V}$$

where H is the magnetic field strength and r is the radius of the circular path in which the ion travels and V = the accelerating voltage.

At particular values for H and V , only ions of a particular mass adopt a flight path that enables them to pass through the collector slit and be detected. If the magnetic field strength is varied, ions across a wide mass range can be detected by the analyser, a typical sweep time for the magnetic field across a mass range of 1000 is 5–10 s but faster speeds are required if high resolution chromatography is being used in conjunction with mass spectrometry. The accelerating voltage can also be varied while the magnetic field is held constant in order to produce separation of ions on the basis of their kinetic energies.

Quadrupole instruments

A cheaper and more sensitive mass spectrometer than a magnetic sector instrument is based on the quadrupole analyser (Fig. 9.2), which uses two electric fields applied at right angles to each other, rather than a magnetic field, to separate ions according to their m/z ratios. One of the fields used is DC and the other oscillates at radiofrequency.

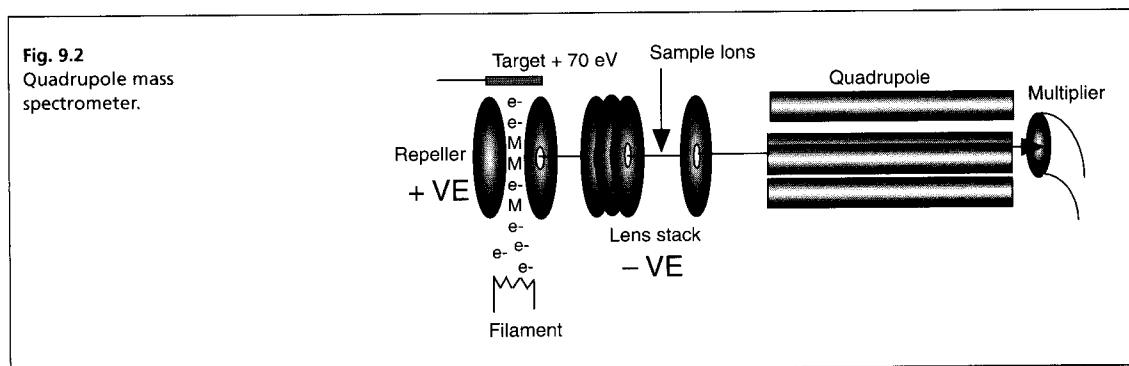

The effect of applying the two electrostatic fields at right angles to each other, one of which is oscillating, is to create a resonance frequency for each m/z value; ions which resonate at the frequency of the quadrupole are able to pass through it and be detected. Thus ions across the mass range of the mass spectrum are selected as the resonance frequency of the quadrupole is varied. A quadrupole instrument is more sensitive than a magnetic sector instrument since it is able to collect ions with a wider range of kinetic energies. The disadvantage of a simple quadrupole mass spectrometer is that it cannot resolve ions to an extent > 0.1 amu whereas a magnetic sector instrument can resolve ions to a level of 0.0001 amu or more. This enables the latter to be used to determine accurate masses for unknown compounds and thus assign their elemental compositions.

Mass spectra obtained under electron impact ionisation conditions

The original type of ionisation employed in mass spectrometry was electron impact (EI) ionisation as described earlier. This type of ionisation uses high energy electrons which produce extensive fragmentation of the bonds within the analyte. It is still very commonly used in standard chemical analyses but is not as readily applicable where molecules are very involatile or unstable. In these cases there is a range of other ionisation techniques which can be applied. These ionisation techniques, which are often used in conjunction with chromatography, are discussed in the sections on GC-MS and LC-MS. However, they may also be applied without prior chromatographic separation having been carried out.

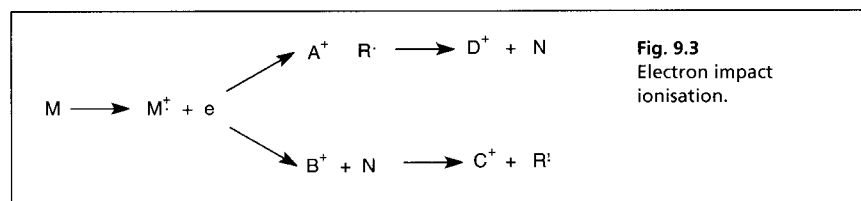

Figure 9.3 shows a generalised scheme for decomposition of a molecule under EI conditions. The principles of the scheme are as follows:

- (i) M^+ represents the molecular ion which bears one positive charge since it has lost one electron and the unpaired electron which results from the loss of one electron is represented by a dot.
- (ii) M^+ may lose a radical which, in a straightforward fragmentation not involving rearrangement, can be produced by the breaking of any single bond in the molecule. The radical removes the unpaired electron from the molecule leaving behind a cation A^+ .
- (iii) This cation can lose any number of neutral fragments (N) such as H_2O or CO_2 but *no further radicals*.
- (iv) The same process can occur in a different order with a neutral fragment (H_2O , CO_2 , etc.) being lost to produce B^+ and since this ion still has an unpaired electron it can lose a radical to produce C^+ ; this ion can thereafter only lose neutral fragments.

To summarise, the following rules apply to mass spectrometric fragmentation:

- (i) The molecular ion can lose only *one* radical but any number of neutral fragments.

- (ii) Once a radical has been lost only neutral fragments can be lost thereafter.

Molecular fragmentation patterns

Homolytic and heterolytic α -cleavage

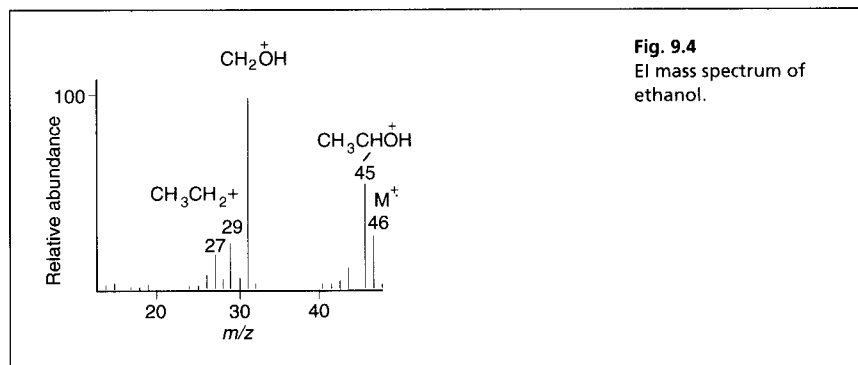

Fig. 9.4
EI mass spectrum of ethanol.

Under EI conditions the analyte develops a positive charge through the loss of one electron. If there is an electronegative atom in the structure of the molecule such as nitrogen or oxygen, this positive charge will be on the electronegative atom(s). If an electronegative atom is absent the charge is more difficult to locate with certainty. Figure 9.4 shows the EI spectrum of ethanol which provides an example of two types of fragmentation. The process is as follows:

- (i) Homolytic α -cleavage (Fig. 9.5) is promoted by the presence of a hetero atom such as oxygen, nitrogen or sulphur and in molecules containing a hetero atom it often gives rise to the most abundant ion in the mass spectrum (the base peak).

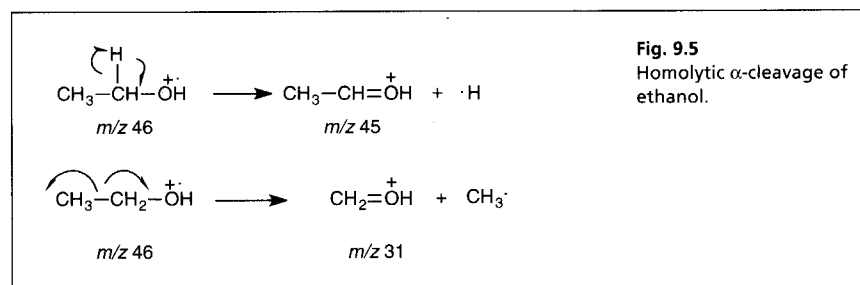

Fig. 9.5
Homolytic α -cleavage of ethanol.

- (ii) One electron in the bond broken goes to the radical and the other combines with the unpaired electron on the hetero atom to produce a double bond; the hetero atom becomes positively charged.
- (iii) Loss of the largest possible radical is most favoured. In the case of ethanol, loss of $\text{CH}_3\cdot$ gives rise to the base peak in the mass spectrum at m/z 31.

For many drug molecules this type of fragmentation dominates their mass spectra. A minor ion in the spectrum of ethanol results from heterolytic α -cleavage (Fig. 9.6).

As is illustrated in Figure 9.7, homolytic α -cleavage is the major fragmentation mechanism for chains containing hetero atoms.

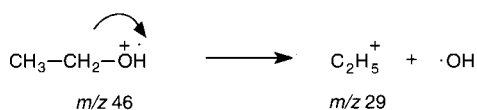

Fig. 9.6
Heterolytic α -cleavage of ethanol.

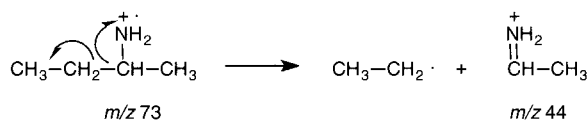
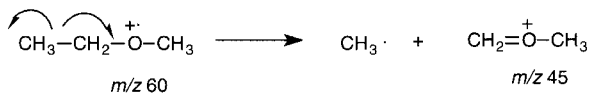
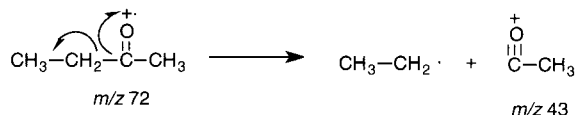
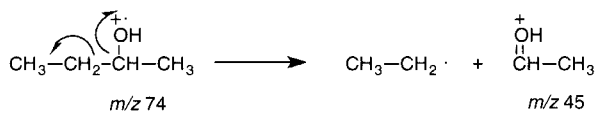
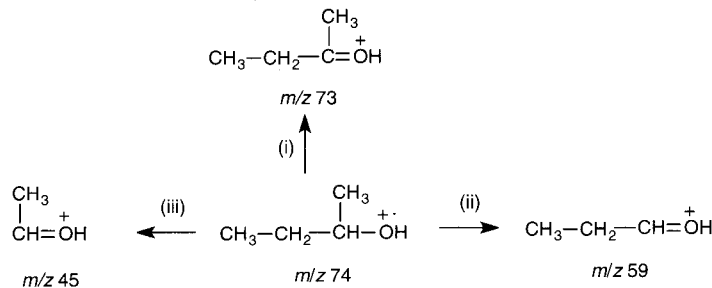

Fig. 9.7
Some further examples of homolytic α -cleavage.

Self-test 9.1

Indicate the type(s) of cleavage and the fragments lost which gives rise to the major ions in the spectrum of butan-2-ol shown in Figure 9.8.



Answers: (i) Homolytic α -cleavage with loss of C_2H_5 ; (ii) Homolytic α -cleavage with loss of H_2 ; (iii) Homolytic α -cleavage with loss of CH_3 ; (iii)

Figure 9.9 shows the spectrum of n-butanol. In this case homolytic α -cleavage, which gives rise to the ion at m/z 31, does not completely dominate the spectrum and the spectrum produced is more complex as a result. Loss of the neutral fragment H_2O occurs via a 1,4 elimination (Fig. 9.10); this produces an ion at m/z 56 which, since it is still a radical cation, gives rise to the fragment at m/z 41 via loss of CH_3 and followed by loss of H_2 as a neutral fragment to give m/z 39.

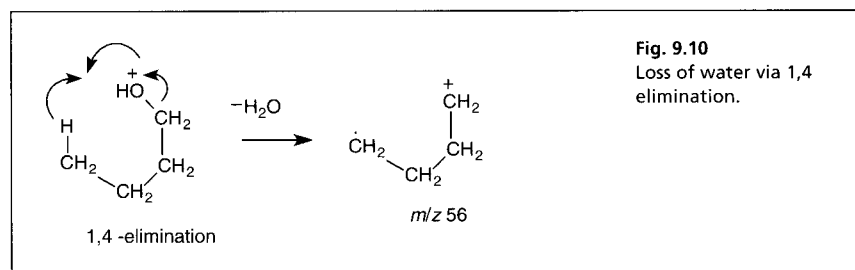
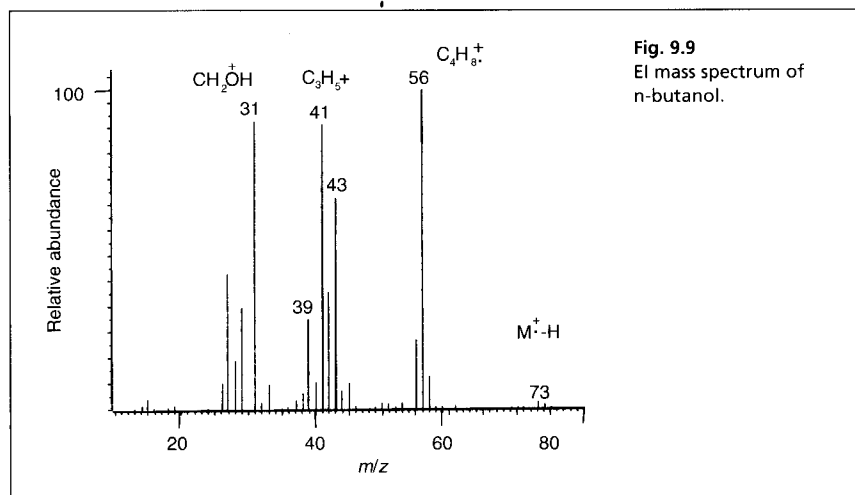
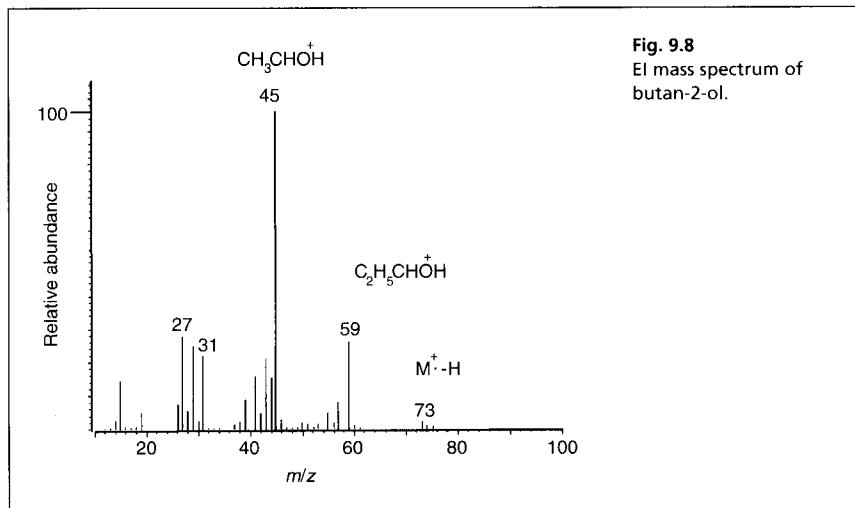

Cleavage with proton transfer

Cleavage with proton transfer is also common in the mass spectra of drug molecules. In the first two examples the initial step is homolytic α -cleavage as shown in Figure 9.11; this is followed by loss of a neutral hydrocarbon fragment.

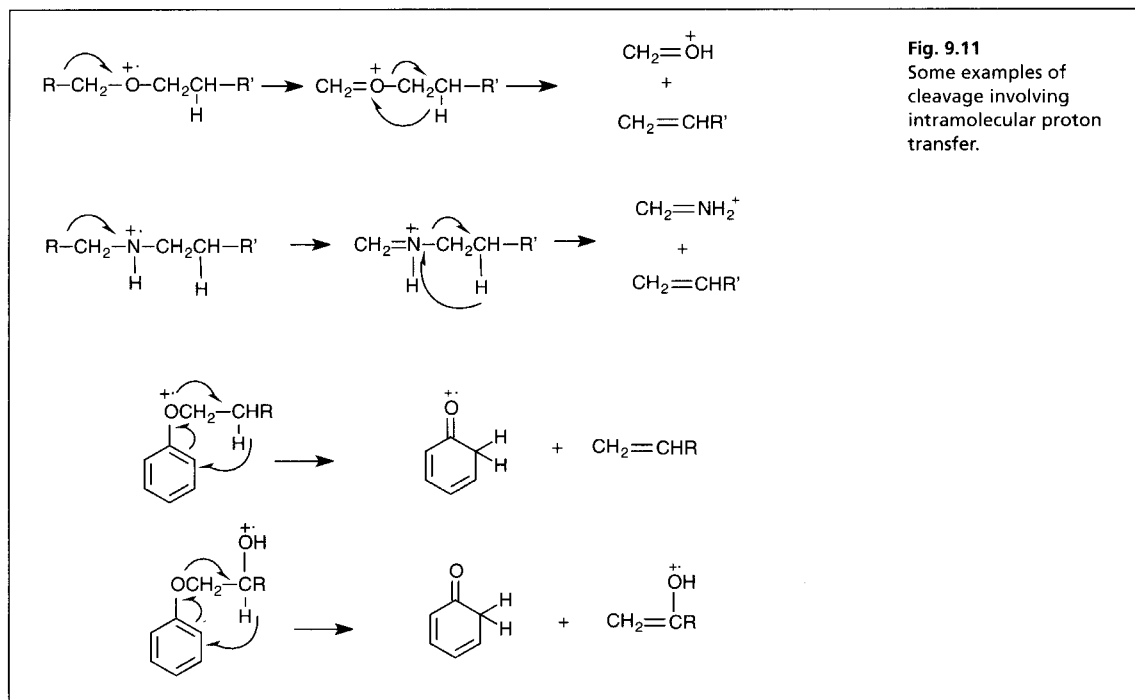

Table 9.1 shows some typical small fragments which are lost from the molecular ions of molecules.

Table 9.1 Common losses from a molecular ion

Loss amu	Radicals/neutral fragments lost	Interpretation
1	H·	Often a major ion in amines, alcohols and aldehydes
2	H ₂	
15	CH ₃ ·	Most readily lost from a quaternary carbon
17	OH· or NH ₃	
18	H ₂ O	Readily lost from secondary or tertiary alcohols
19/20	F·/HF	Fluorides
28	CO	Ketone or acid
29	C ₂ H ₅ ·	
30	CH ₂ O	Aromatic methyl ether
31	CH ₃ O·	Methyl ester/methoxime
31	CH ₃ NH ₂	Secondary amine
32	CH ₃ OH	Methyl ester
33	H ₂ O + CH ₃ ·	
35/36	Cl·/HCl	Chloride
42	CH ₂ =C=O	Acetate
43	C ₃ H ₇ ·	Readily lost if isopropyl group present
43	CH ₃ CO·	Methyl ketone
43	CO + CH ₃ ·	
44	CO ₂	Ester
45	CO ₂ H·	Carboxylic acid
46	C ₂ H ₅ OH	Ethyl ester
46	CO + H ₂ O	
57	C ₄ H ₉ ·	
59	CH ₃ CONH ₂	Acetamide
60	CH ₃ COOH	Acetate
73	(CH ₃) ₃ Si·	Trimethylsilyl ether
90	(CH ₃) ₃ SiOH	Trimethylsilyl ether

Fragmentation of ring structures

More complex types of fragmentation involve rearrangement of the structure of a molecule prior to fragmentation and this is more likely to occur if the molecule has a ring in its structure. Figure 9.12 shows the EI spectrum of cyclohexanol.

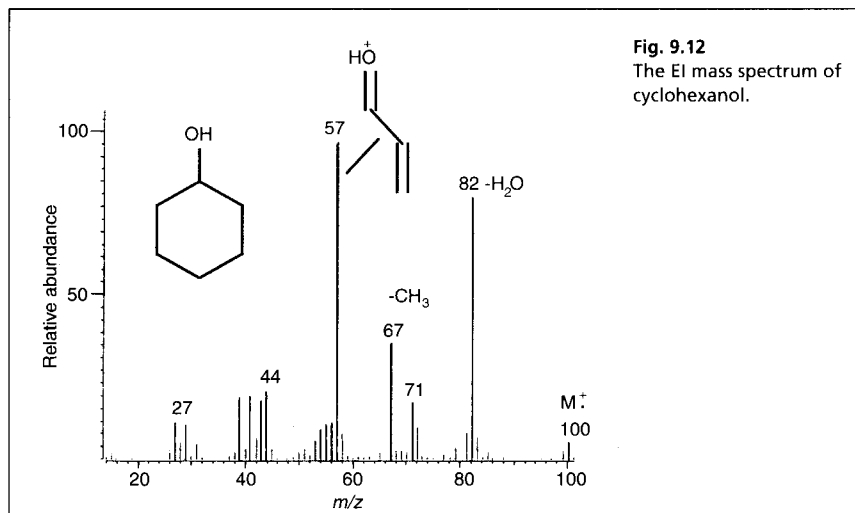

Fig. 9.12
The EI mass spectrum of cyclohexanol.

The major ions in the spectrum are due to the loss of the neutral fragment water, as in the case of *n*-butanol 1,4 elimination is probably involved. The base peak is formed via homolytic cleavage next to the OH group followed by proton transfer (Fig. 9.13). The base peak of the mass spectrum is formed as shown in Figure 9.13.

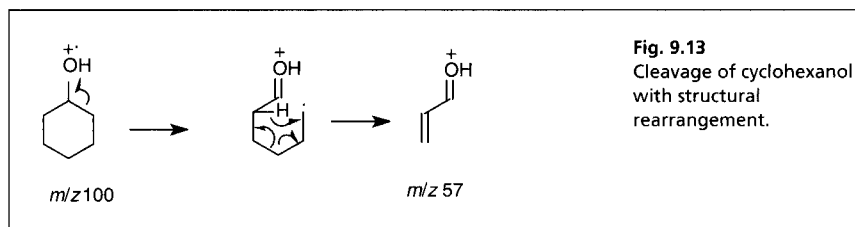

Fig. 9.13
Cleavage of cyclohexanol with structural rearrangement.

Retro Diels–Alder fragmentation is another type of fragmentation which occurs in compounds with ring systems.

The peak at m/z 68 in the mass spectrum of limonene results from the molecule breaking in half as shown in Figure 9.14.

EI mass spectra of some drug molecules

Examples where the molecular ion is abundant

In the case of some drugs the molecular ion may be abundant in the mass spectrum. Figure 9.15 shows the mass spectrum of codeine, where the molecular ion at m/z 299 is the base peak. The extended ring structure of the molecule means that apart from the abundant molecular ion, the fragmentation of codeine is not easy to interpret because of the structural rearrangements which occur. The only other ion in the mass spectrum of codeine closely related to the molecular ion is at m/z 229 and formation of this ion involves some rearrangement of the ring structure.

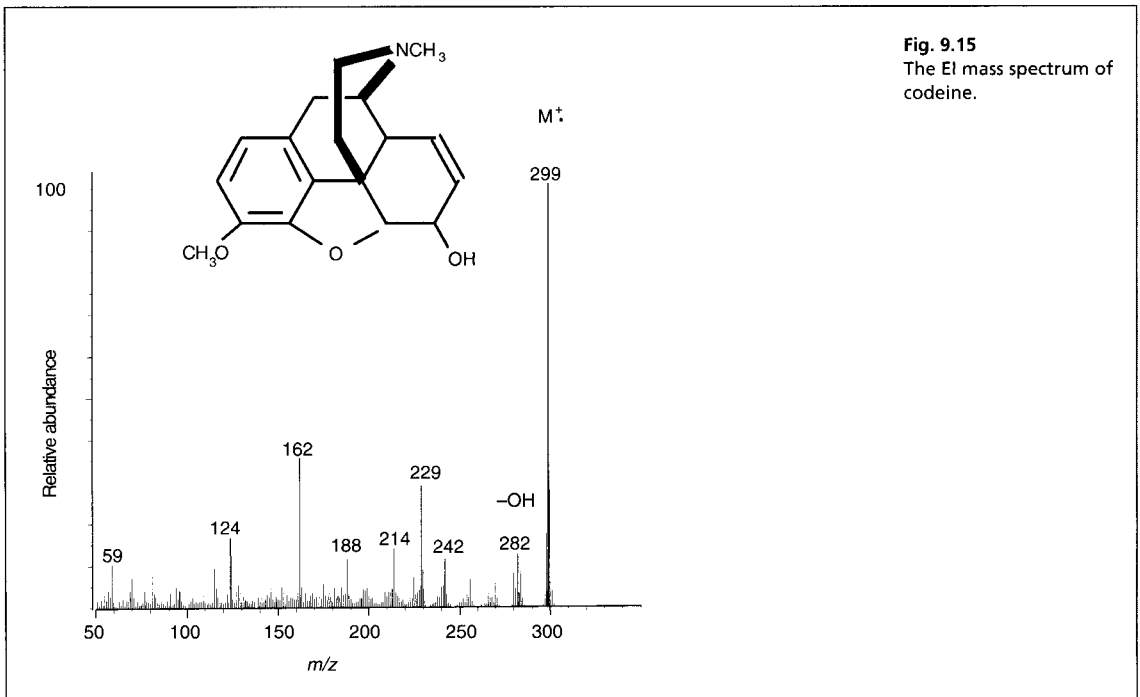
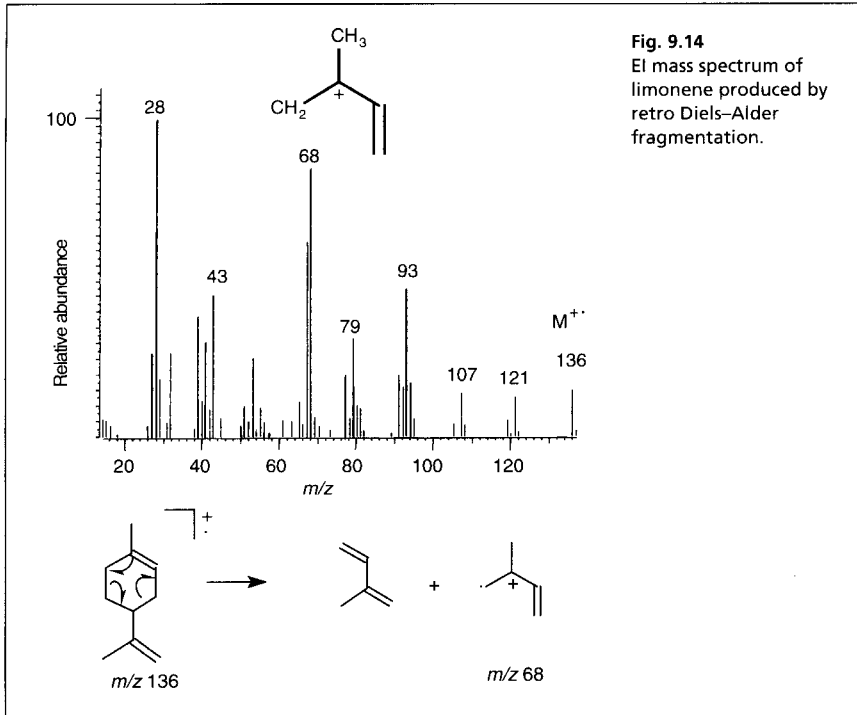

Drugs which yield abundant molecular ions under EI conditions include: caffeine, coumatetralyl, cyclazocine, dextromethorphan, dichlorphenamide, diflunasil, dimoxyline, fenclofenac, flurbiprofen, griseofulvin, harmine, hydralazine, hydroflumethiazide, ibogaine, ketotifen, levallorphan, methaqualone, nalorphine. These drugs are characterised by having ring structures without extensive side chains, or if side chains are present, they do not contain hetero atoms which would direct cleavage to that part of the molecule.

Drug molecules in which homolytic α -cleavage dominates the spectrum

Since many drugs contain hetero atoms the fragmentation of drug molecules is often directed by α -homolytic cleavage adjacent to these atoms. Figure 9.16 shows the mass spectrum of bupivacaine, where homolytic α -cleavage is directed by the nitrogen atom in the heterocyclic ring resulting in an ion at m/z 140, which dominates the spectrum.

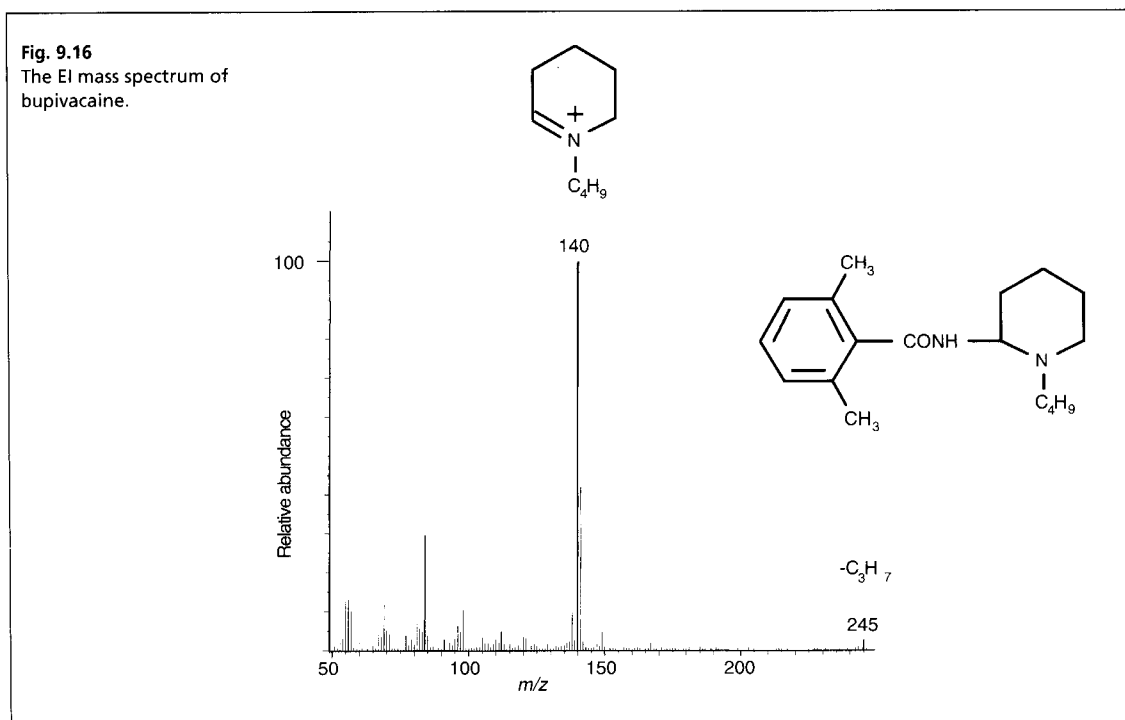

A similar type of fragmentation dominates the spectrum of other local anaesthetics such as prilocaine and procaine; and sympathomimetics such as ephedrine, salbutamol and terbutaline and β -adrenergic blockers such as propranolol and oxyprolol.

Isotope peaks

Figure 9.17A shows the mass spectrum of chloroquine under EI conditions. This molecule gives a spectrum typical of a basic compound with a side chain. In this case homolytic α -cleavage takes place adjacent to the nitrogen in the side chain with

the charge being retained on the smaller portion of the molecule resulting in an ion at m/z 86. Another feature of the spectrum which can be noted is the double molecular ion which occurs at m/z 319 and m/z 321, and which arises from the presence of a chlorine atom in the molecule. Chlorine has two common isotopes with atomic masses 35 and 37 in the ratio 3:1, and the small molecular ion for chloroquine at m/z 319 has a peak associated with it in a 3:1 ratio at m/z 321. This is seen more clearly in the negative ion chemical ionisation (NICI) spectrum of chloroquine (Fig. 9.17B). NICI is a soft ionisation technique which produces little, if any, fragmentation in a molecule and results in an abundant molecular ion. In this case, the chlorine isotope peak for chloroquine at m/z 321 can be seen clearly. Bromine in the structure of a molecule will also produce an isotope pattern since it has isotopes with atomic weights of 79 and 81 which occur in more or less a 1:1 ratio. These typical patterns can be useful in characterisation of impurities in synthetic drugs because reactive intermediates which are used in drug synthesis may contain bromine or chlorine. If more than one chlorine or bromine atom is present, then the isotope pattern is more complex.

The isotopes of all the other elements commonly found in drug molecules are much less abundant, although because of the number of carbon atoms in large

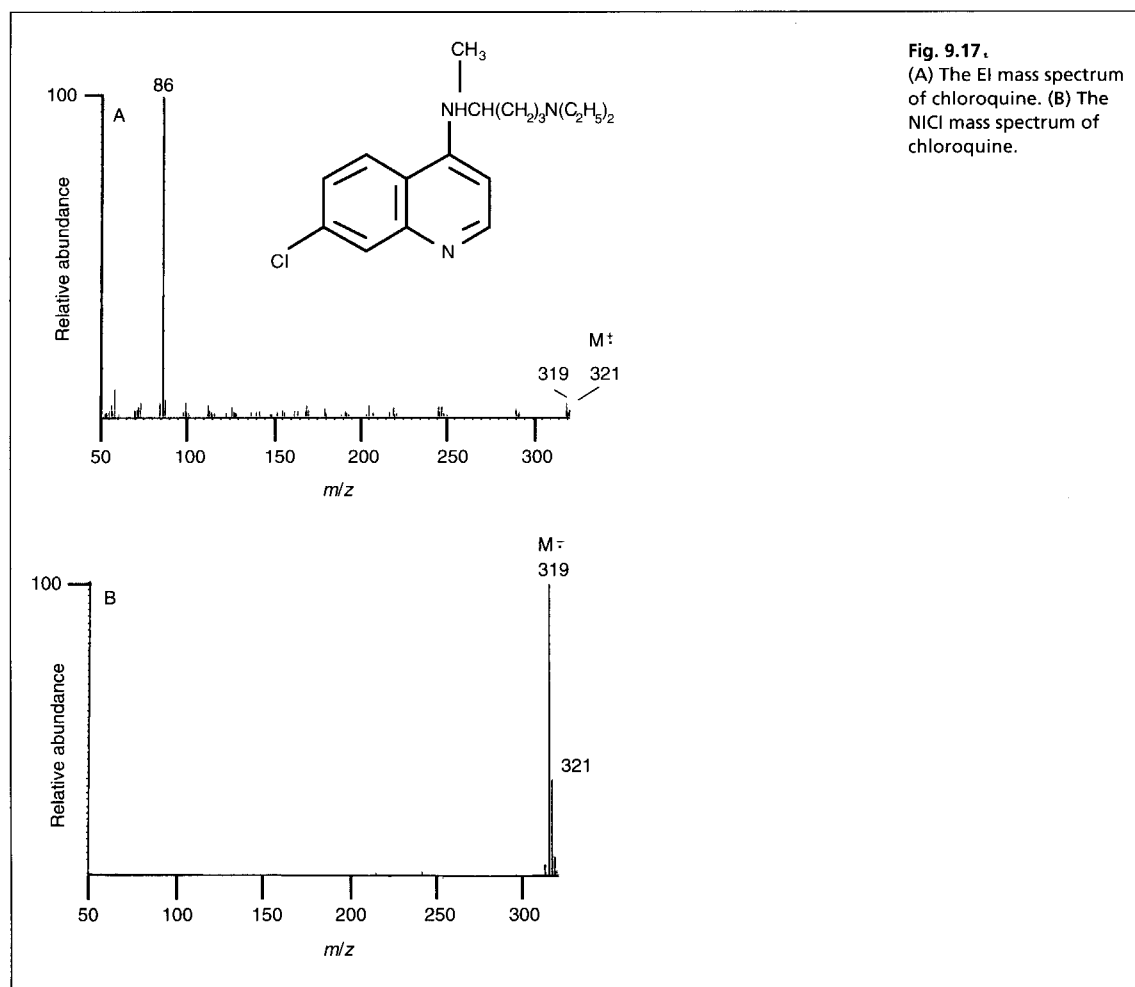
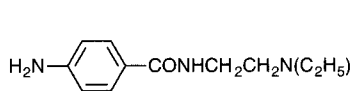

Fig. 9.17. (A) The EI mass spectrum of chloroquine. (B) The NICI mass spectrum of chloroquine.

Self-test 9.2

Predict the base peak in mass spectra of the following molecules:



(i) Procainamide

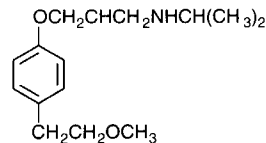

(ii) Metoprolol

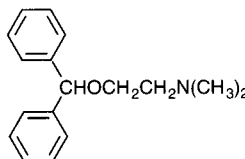

(iii) Diphenhydramine

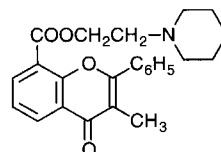

(iv) Flavoxate

Answers: The mass spectra of all these molecules are dominated by homolytic α -cleavage next to the nitrogen atom in their side chains. (i) m/z 86; (ii) m/z 72; (iii) m/z 58; (iv) m/z 98.

molecules, the $M+1$ ion for carbon is usually substantial. Although the abundance of carbon-13 is only 1.1% compared with carbon-12, the presence of 40 carbon atoms in a molecule would give rise to an $M+1$ ion with a 44% abundance since there is a 44% probability that the molecule will contain a carbon-13 atom.

Tropylium ion

Another type of directed fragmentation occurs in molecules which have a benzyl group. For instance, the spectrum of levodopa (L-dopa) is dominated by an ion at m/z 123 which arises from the formation of a tropylium ion as shown in Figure 9.18. This ion is readily formed in any compound with a benzyl group. The benzyl CH_2 becomes incorporated into a seven-membered ring structure in which the positive charge on the ion is delocalised around the ring structure, giving a very stable cation. Of course other types of fragmentation can compete; in the case of L-dopa, homolytic cleavage next to the nitrogen atom is possible which gives rise to a fragment at m/z 74, but this fragment is of lower abundance than the fragment at m/z 123.

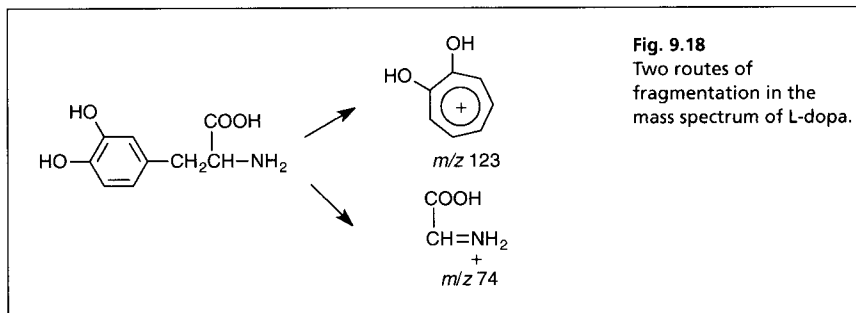
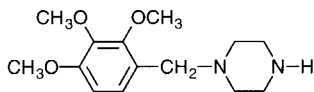

Fig. 9.18
Two routes of
fragmentation in the
mass spectrum of L-dopa.

Self-test 9.3

Predict the likely base peak in the mass spectra of the following molecules:



(i) Trimetazidine

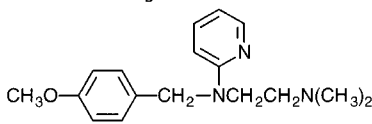

(ii) Mepyramine

Answers: Both molecules yield tropylium ions as the base peak in their mass spectra. (i) $C_{10}H_{13}O_3^+$ m/z 181; (ii) $C_8H_9O^+$ m/z 121

McLafferty rearrangement

McLafferty rearrangement can occur in carboxylic acids, esters, ketones and amides which have a side chain containing at least three carbon atoms. The generalised fragmentation is shown in Figure 9.19. For example, the sedative drug apronal has a McLafferty fragment as a major ion in its mass spectrum arising as shown in Figure 9.20.

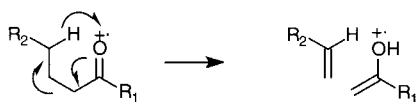

$R_1 = CH_2R, OH, OR, NHR.$

$R_2 = H$ or alkyl

Fig. 9.19
The McLafferty
rearrangement.

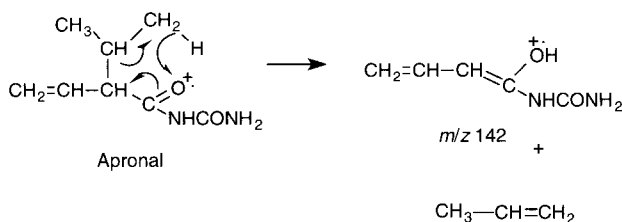

Fig. 9.20
McLafferty
fragmentation of
apronal.

This type of fragmentation is not particularly common in drug molecules, often because where it is possible homolytic α -cleavage dominates the spectrum, but it is a feature of long chain lipid molecules such as fatty acid esters.

Gas chromatography–mass spectrometry (GC–MS)

For the chromatographic aspects of GC–MS, refer to Chapter 11. Gas chromatography (G–C) was the earliest chromatographic technique to be interfaced to a mass spectrometer. The original type of gas chromatograph had a packed GC column with a gas flow rate passing through it at *ca* 20 ml/min and the major problem was how to interface the GC without losing the mass spectrometer vacuum.

This was solved by use of a jet separator where the column effluent was passed across a very narrow gap between two jets and the highly diffusible carrier gas was largely removed, whereas the heavier analyte molecules crossed the gap without being vented. The problem of removing the carrier gas no longer exists since GC capillary columns provide a flow rate of 0.5–2 ml/min, which can be directly introduced into the mass spectrometer without it losing vacuum.

Ionisation techniques used in GC–MS

There are three main types of ionisation used with GC–MS, which will be discussed in turn.

Electron impact

This type of ionisation has been discussed earlier in this chapter. The mass spectrum of psoralen under EI conditions is shown in Figure 9.21 along with the corresponding GC trace, which is produced by the total ion current (TIC) across the scan range of the mass spectrum. The molecular ion M^+ is in this case in good abundance at m/z 186 and other ions arise as follows: m/z 158 ($M^+ - CO$), m/z 130 ($M^+ - 2CO$), m/z 102 ($M^+ - 3CO$).

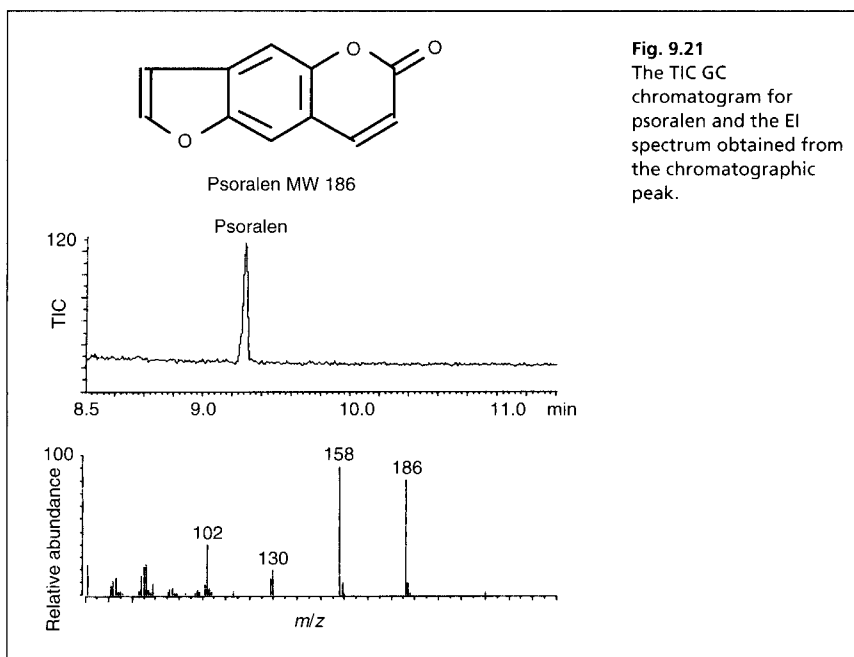

Positive ion chemical ionisation (PICI)

In the PICI mode a reagent gas is continuously introduced into the ion source, e.g. methane (isobutane and ammonia are also used). The gas interacts with electrons produced by the filament to produce a series of ions shown in Figure 9.22.

The positively charged ions can either associate with the analyte or can transfer a proton to the analyte. The most commonly observed adduct ions are illustrated by the PICI spectrum of psoralen (Fig. 9.23). In this case, the ions arise via addition

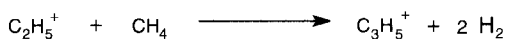
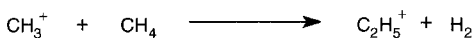
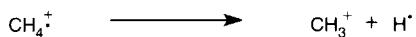
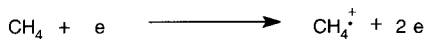
**Fig. 9.22**

The ions generated from methane which produce PICI.

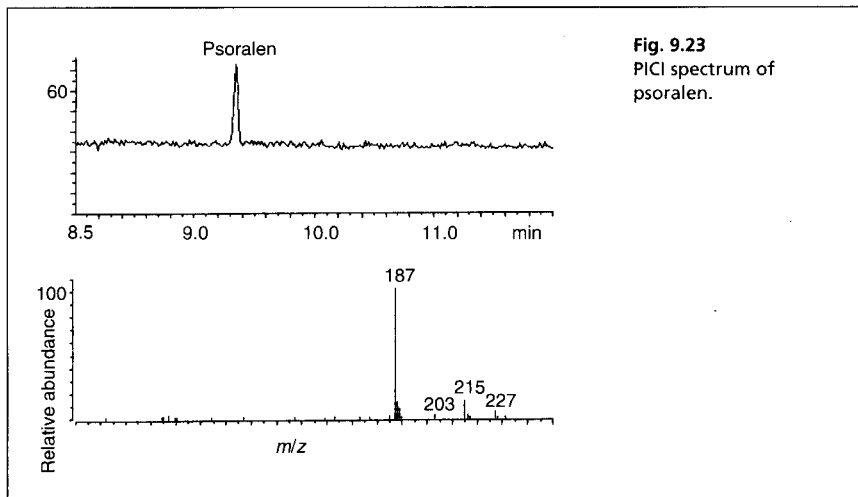
**Fig. 9.23**

PICI spectrum of psoralen.

of: H^+ (m/z 187), C_2H_5^+ (m/z 215) and C_3H_5^+ (m/z 227) to the molecular ion. The signal:noise ratio indicated by the baseline of the corresponding GC trace shows that, while the fragmentation of the molecule is reduced, ionisation efficiency is also reduced in comparison with EI.

Negative ion chemical ionisation (NICI)

The most common form of ionisation occurring in the case of negative ion spectra is electron capture ionisation. Again a reagent gas is used and the electrons collide with it so that their energies are reduced to $< 10\text{eV}$. Molecules with a high affinity for electrons are able to capture these low energy thermal electrons. This is often loosely called NICI but since it does not involve the formation of a chemical adduct it is not strictly chemical ionisation. The two commonly observed types of electron capture are shown in Figure 9.24.

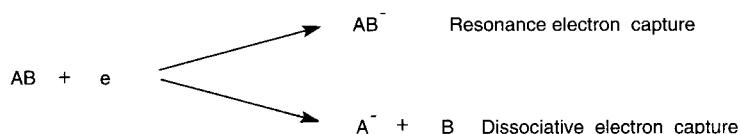
**Fig. 9.24**

The NICI spectrum of psoralen (Fig. 9.25) indicates that resonance capture is occurring so that most of the ion current is carried by the molecular ion at m/z 186. The associated GC trace indicates that ionisation is *ca* 10 times more efficient for the same amount of psoralen in comparison with EI. In addition, since most of the ion current is channelled into the molecular ion, an analytical method which selectively monitored the molecular ion of psoralen would be *ca* 40 times more sensitive if NICI conditions were used rather than EI. The technique only works for compounds which are electron capturing. The small ion at m/z 218 indicates that the psoralen has also formed an adduct with traces of oxygen present in the instrument, i.e. true chemical ionisation.

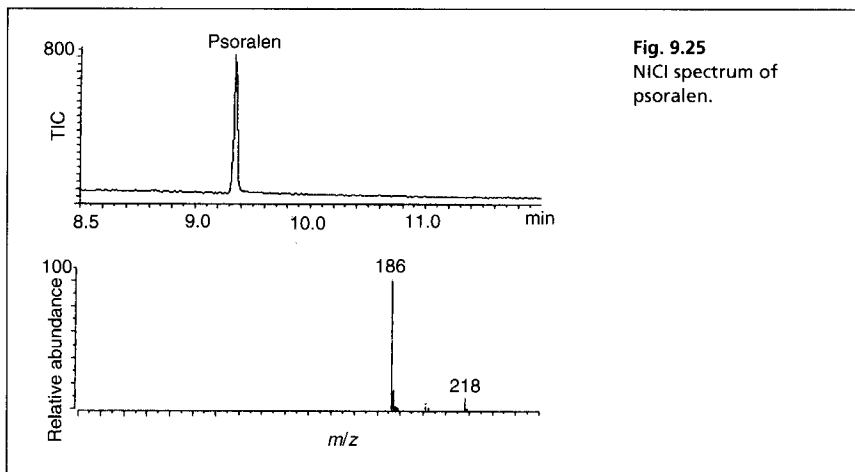

Applications GC–MS to impurity profiling

With the advent of requirements by the American Food and Drug Administration (FDA) for identification of any impurity at a level of $> 0.1\%$ in pharmaceuticals, mass spectrometry with chromatography has found a role in impurity identification. Such impurities can arise either from the manufacturing process or from degradation of the drug. Figure 9.26 shows a GC–MS trace for a commercial sample of the β -blocker propranolol. The synthetic route leading to propranolol is shown in Figure 9.27.

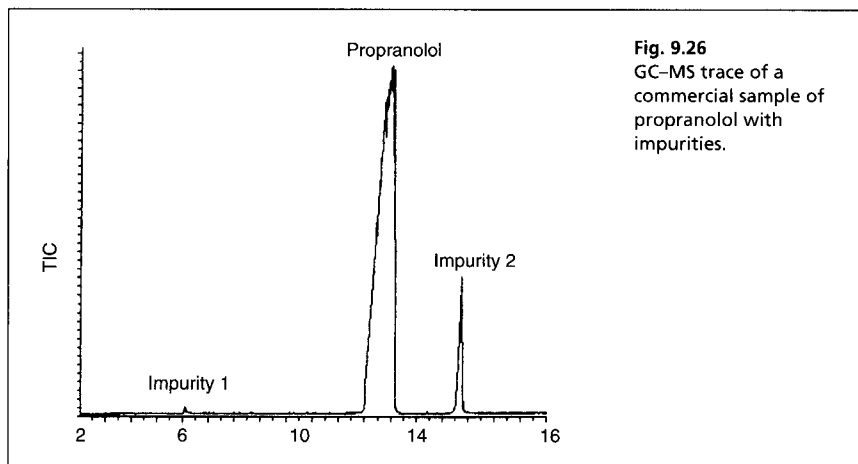

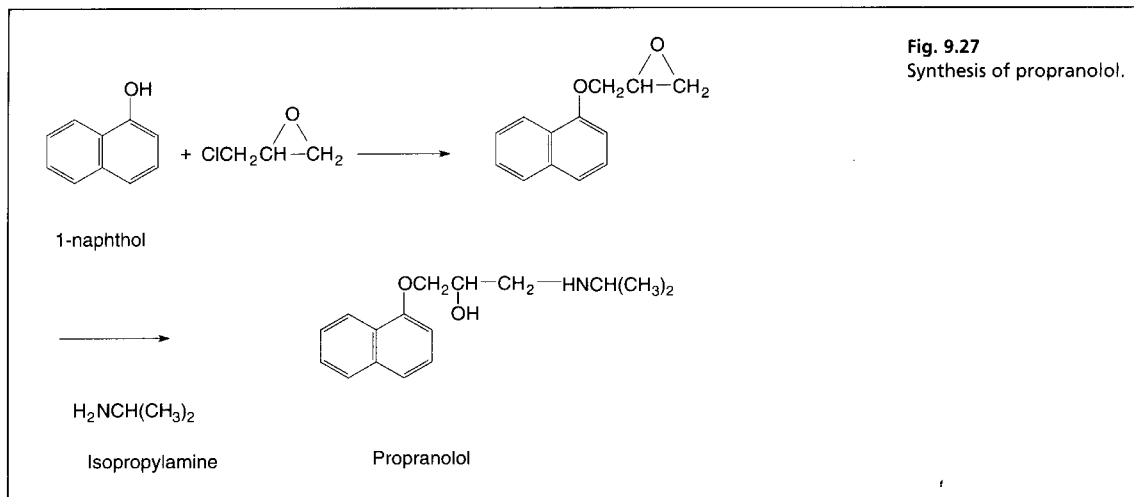

There is one major additional peak in the sample which runs after propranolol (impurity 2). The mass spectrum for propranolol is shown in Figure 9.28.

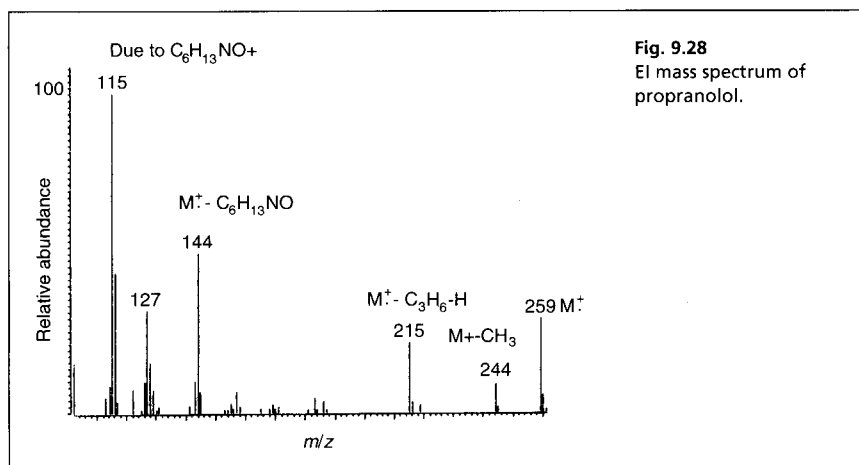

The molecular ion can be seen at m/z 259 and the two major fragment ions at m/z 144 and 115 arise as shown in Figure 9.29.

The impurity peak shows a major fragment at m/z 158 (Figure 9.30). This compound must have a molecular weight higher than that of propranolol since its GC retention time is longer. However, there is no substantial ion of molecular weight higher than that of propranolol in its mass spectrum. The mass spectrum of the impurity under PCI conditions is shown in Figure 9.31.

Impurity 2 gives an apparent molecular ion at m/z 302 and also shows a major fragment at m/z 158. This information is consistent with an additional isopropyl being attached to the nitrogen in propranolol as shown in Figure 9.32. The fragment at m/z 158 observed both under EI and PCI conditions arises as shown in Figure 9.32. Thus, this extra peak is manufacturing impurity, probably arising from a small amount of diisopropylamine being present in isopropylamine used as a reagent in one

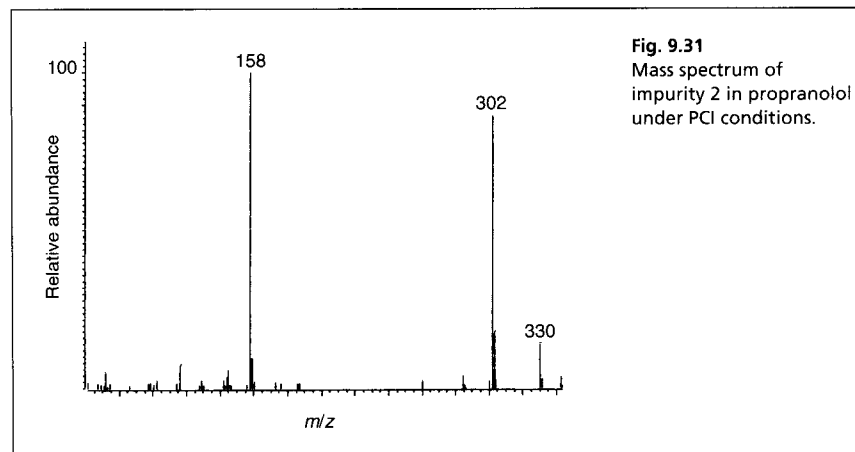
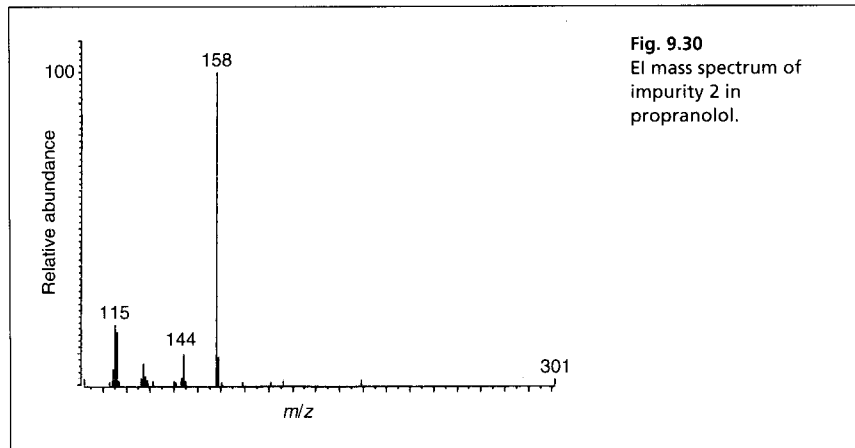
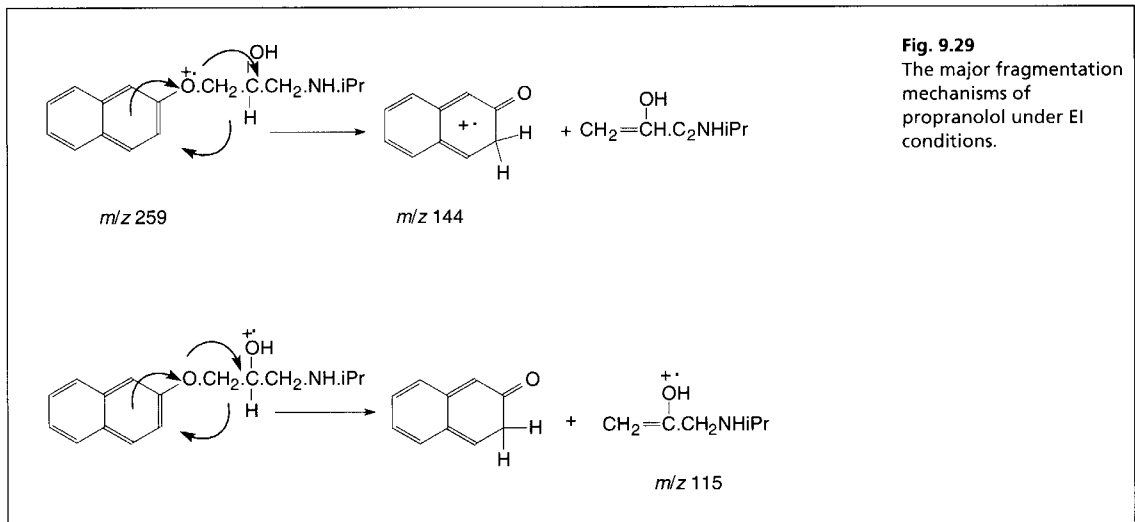

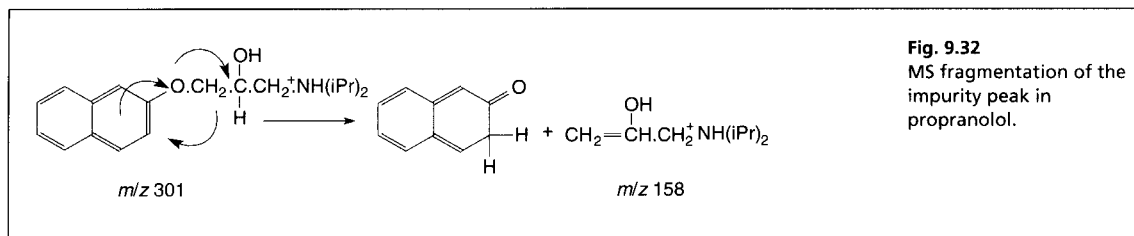

Fig. 9.32
MS fragmentation of the
impurity peak in
propranolol.

of the later stages of the synthesis. It is also possible to detect in the propranolol sample a very minor amount of 1-naphthol, impurity 1 (Fig. 9.26), which is used in an earlier stage of its synthesis.

Liquid chromatography–mass spectrometry (LC–MS)

The interfacing of a liquid chromatograph to a mass spectrometer proved much more difficult than interfacing a gas chromatograph since each mole of solvent introduced into the instrument produces 22.4 l of solvent vapour, even at atmospheric pressure. The technique has made huge advances in the last 10 years and there are many types of interface available, the most successful of which are the electrospray and atmospheric pressure ionisation sources. Table 9.2 summarises the major types of LC–MS interface which are available. In many cases, LC flow rates have to be in the range 10–100 μ l per min so that either splitting of the eluent from a normal column is required or microbore chromatography is used. Table 9.3 summarises some additional ion separation methods which are used in conjunction with liquid chromatography.

Table 9.2 LC–MS interfaces

Interface	Comments
<p>Particle beam</p>	<p>Useful interface which is applicable to a wide range of molecules. The volatile solvent molecules are stripped from the sample and lost in a process similar to that used in the early jet separators used in GC–MS. The heavier sample molecules enter the MS and can be ionised by the standard methods of EI, PICl or NlCl. Gives spectra with EI fragmentation which can be referred for identification to EI spectral libraries built up over many years. No solvent background thus sensitive to the 10^{-12} g level. Solvent flow rate up to 1 ml/min, mass range up to 1000 amu</p>
<p>Thermospray</p>	<p>The eluent from the column is vapourised and a portion of the vapour (ca 1%) is transferred to the mass spectrometer and the rest of the vapour is pumped to waste. The spectra produced are like CI spectra since the presence of solvent vapour with the sample reduces the energy of the ionisation process and adducts can be formed with the solvent. Sensitive to the 10^{-9} g level; mass range up to 2000 amu</p>

Table 9.2 LC-MS interfaces (Cont.)

Interface	Comments
<p>FRIT-FAB (fast atom bombardment)</p>  <p>Capillary from LC, mobile phase contains 1% of involatile matrix, e.g. glycerol</p>	<p>The mobile phase enters the instrument directly so that the flow rates can only be ca 10 $\mu\text{l}/\text{min}$. The mobile contains 1% of an involatile matrix, e.g. glycerol. The sample flows out onto the centre of a porous disc and the solvent, apart from the involatile matrix, evaporates. The sample in the matrix is struck by fast atoms (Xe or Cs) from a FAB gun and the high energy of the atoms generates ions from the sample. Soft ionisation technique produces limited fragmentation. Sensitive to 10^{-12} g level for lipophilic compounds, mass range up to 2000 amu or more</p>
<p>Electrospray (ES) ionisation</p>  <p>Capillary from LC at high voltage + 3kV</p>	<p>The most common LC-MS interface. Flow rates up to 1 ml/min but best at 200 $\mu\text{l}/\text{min}$ or below. A charged aerosol is generated at atmospheric pressure and the solvent is largely stripped away with a flow of N_2 gas. The charged molecules are drawn into the MS by electrostatically charged plates. Can determine both small molecules and molecules up to 200 000 amu. Spectra can be simple, containing molecular ion only, or fragmentation can be induced by varying the cone voltage. More suitable for polar molecules</p>
<p>Atmospheric pressure ionisation (API)</p>  <p>Capillary from LC</p>	<p>Very similar to ES but can operate at normal LC flow rates 0.2-2 ml/min. ES instruments can be simply converted to run this technique. Ionisation is more analogous to CI with the corona discharge producing ions such as H_3O^+ and N_2^+, which promote the ionisation of the sample. Complementary to ES since this interface will ionise less polar molecules</p>

Table 9.3 Additional ion separation methods

Matrix-assisted laser desorption with time of flight (MALDI-TOF)

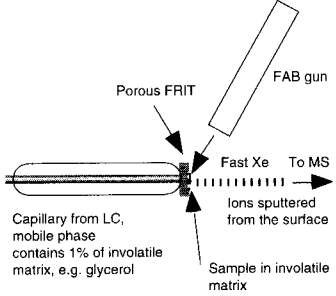
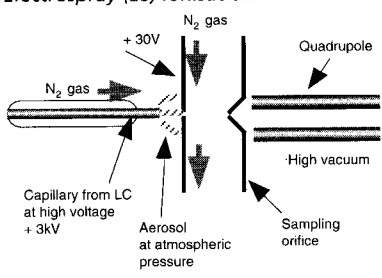
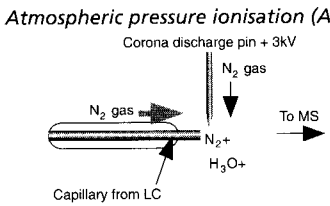
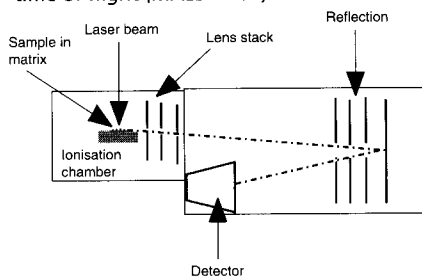
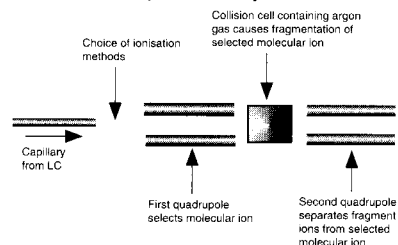

Can be used for very large proteins > 200 000 amu. The sample is dissolved in a light-absorbing matrix, soft ionisation is promoted by a pulsed laser and ions are ejected from the matrix and accelerated using an electrostatic field into a field-free region. The lighter ions travel fastest. In order to improve resolution a device called a 'reflectron' is used to focus the kinetic energies of a population of a particular ion prior to its entering a field-free region. The length of time taken for ions to reach the detector gives their molecular weight (MW). The pulsed nature of the ionisation ensures there is no overlap between spectra. Ideal technique for characterisation of the MW of large proteins

Table 9.3 Additional ion separation methods (Cont.)**Tandem mass spectrometry**

Commonly known as MS–MS. One quadrupole is used to filter out the molecular ion of the compound of interest which is introduced into a collision cell where argon gas is used to induce further diagnostic fragmentation of the molecular ion. The secondary fragments can then be separated with a second quadrupole. Three or four quadrupoles can be used to produce even more filtering. The technique can remove the need for a chromatographic step replacing it with high-speed ion filtering

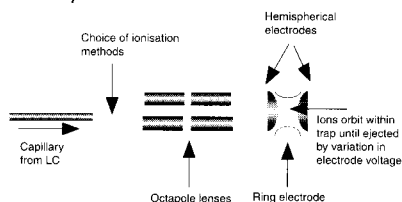
Ion trap

The ion trap separates ions by capturing them within a circular electrode where they orbit until they are ejected by a variation in voltage. The technology is developing rapidly and has advantages over a quadrupole in that ions can be trapped while tandem MS-type fragmentation is produced. Can filter out background while the ion of interest is retained in the trap before being further fragmented and ejected

Applications of LC–MS in pharmaceutical analysis

Determination of impurities in insulin-like growth factor with ES–MS

ES–MS provides an excellent means for quality control of recombinant proteins, some of which are now used as drugs, e.g. human insulin, interferons, erythropoietin and tissue plasminogen activating factor.¹ The advantage of ES–MS in the determination of proteins is that multiple charges can be formed on a protein to bring it within range of standard mass spectrometers which have a mass range of 1000–2000 amu. A protein with a charge of 10+ and a MW of 10 000 would show up at 1000 amu. It would be further characterised by having ions in a series bearing different charges, e.g. 909 (11+), 1000 (10+), 1111 (9+), 1250 (8+), etc. The simplicity of the single ion spectra for each charge number means that small amounts of related proteins that may contaminate the main protein show up quite clearly. Thus, variations in protein structure such as degree of glycosylation or in the terminal amino acids of the protein can be seen quite clearly.

An example of how ES–MS can be used to determine minor impurities in a recombinant protein is shown in Figure 9.33, where some small additional ions in the mass spectrum of recombinant insulin-like growth factor (IGF) can be seen. The major ions in the spectrum are due to IGF itself bearing varying charge but the minor impurities also give rise to peaks and these can be interpreted as shown in Table 9.4.

Before the advent of this technique the determination of protein molecular weight was a laborious process and control and identification of minor impurities more or less impossible.

Characterisation of a degradant of famotidine

Tablets of famotidine, an anti-ulcer compound, were subjected to stress conditions in pack.² Figure 9.34 indicates the profile obtained from analysis of an extract from the stressed tablets by LC-atmospheric pressure chemical ionisation mass spectrometry (APCIMS). The structure of famotidine is shown in Figure 9.35.

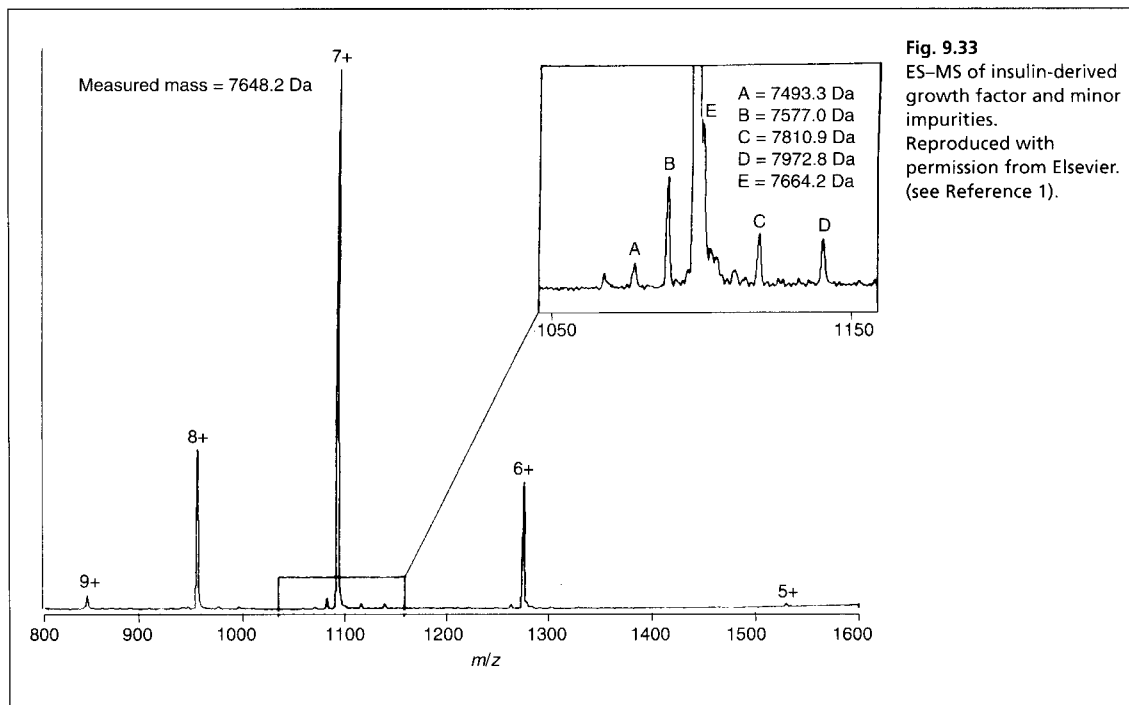

Fig. 9.33
ES-MS of insulin-derived growth factor and minor impurities. Reproduced with permission from Elsevier. (see Reference 1).

Table 9.4 Minor impurities in IGF

Assignment	MW Da
IGF	7648
IGF-N terminal glycine-proline	7494
IGF-C terminal alanine	7577
IGF oxidised methionine	7664
IGF + hexose	7810
IGF + 2 × hexose	7972

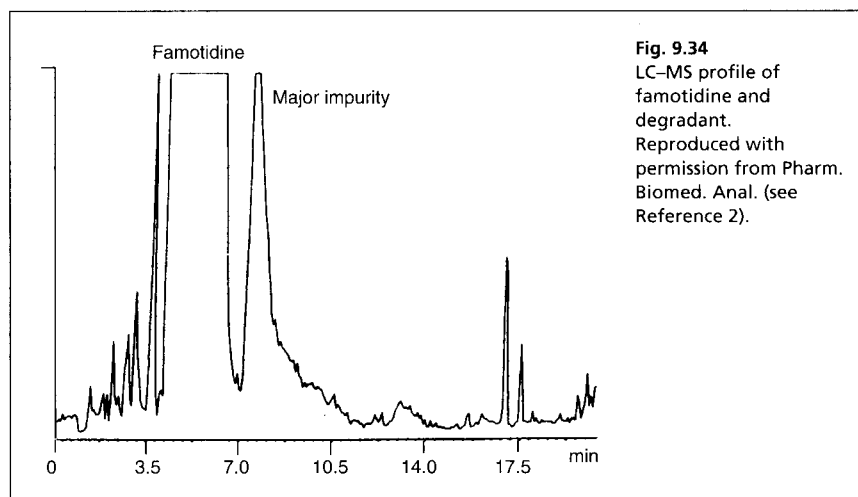

Fig. 9.34
LC-MS profile of famotidine and degradant. Reproduced with permission from Pharm. Biomed. Anal. (see Reference 2).

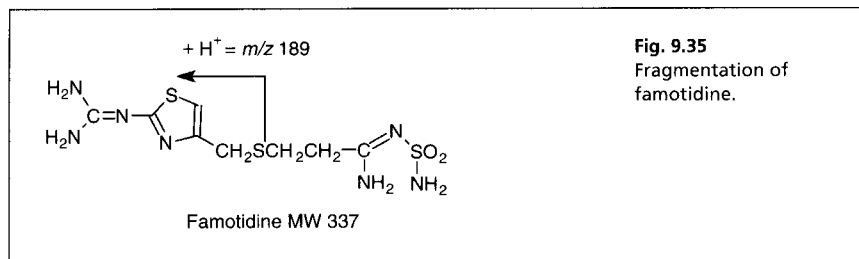
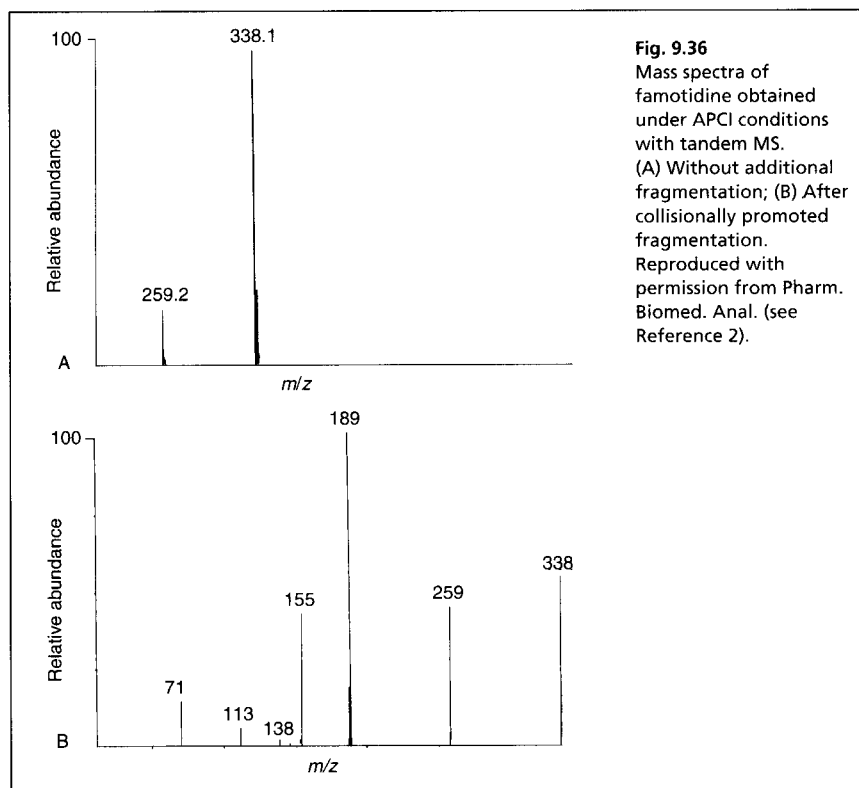
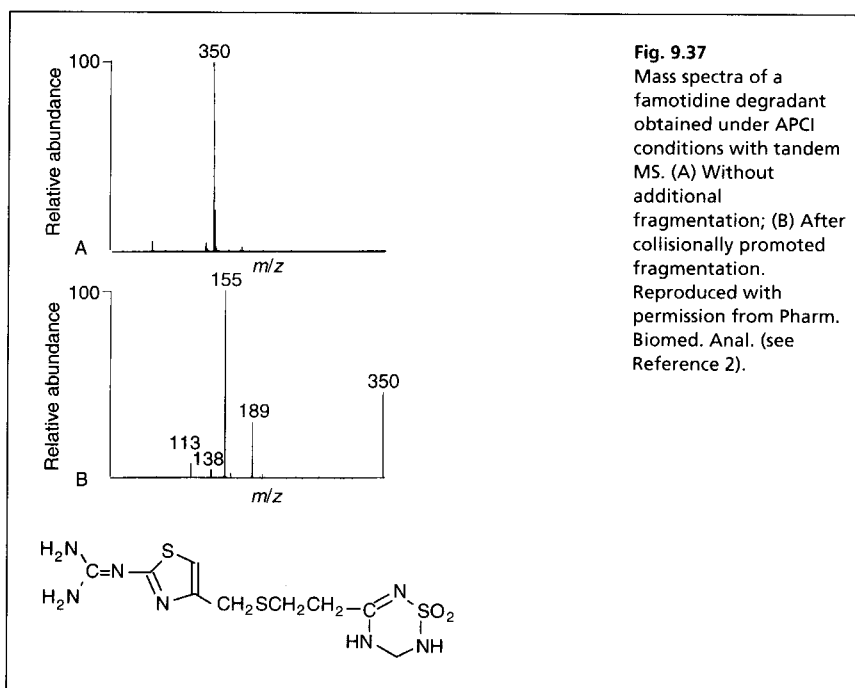

Fig. 9.35
Fragmentation of famotidine.

The mass spectra obtained for famotidine and its degradant by APCIMS and APCIMS-MS are shown in Figures 9.36 and 9.37.



The degradant had a MW 12 amu higher than that of famotidine. The fragment at m/z 189 was common to both spectra, indicating that the two molecules were similar in structure. The degradant was found to have the structure shown in Figure 9.38 and was proposed to result from reaction of famotidine with formaldehyde residues present in the packaging. The structure of the degradant was confirmed by synthesis of a standard for the degradant by reaction of famotidine with formaldehyde.



Profiling impurities and degradants in butorphanol tartrate

HPLC coupled to an ES-MS was used to elucidate the structure of a number of degradants in butorphanol³ following its storage in aqueous solution. Figure 9.38 shows the LC-MS profile of the degradants which were detected in butorphanol.

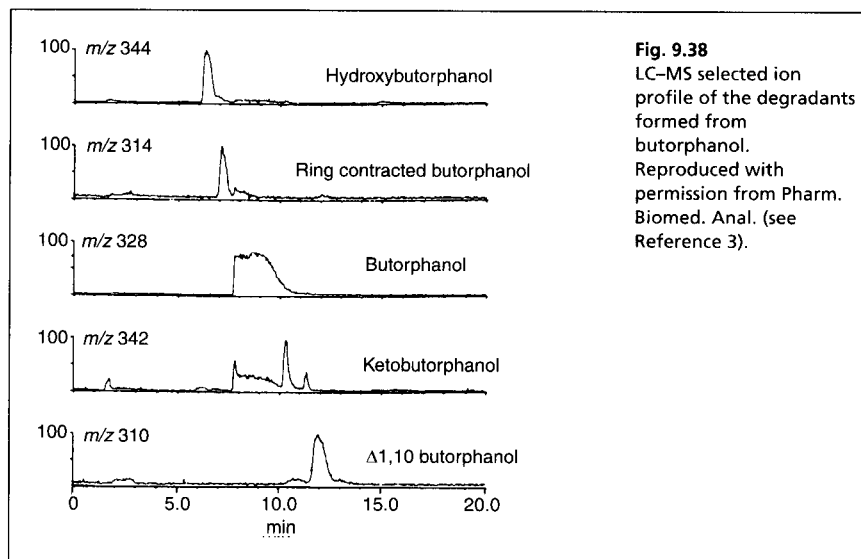
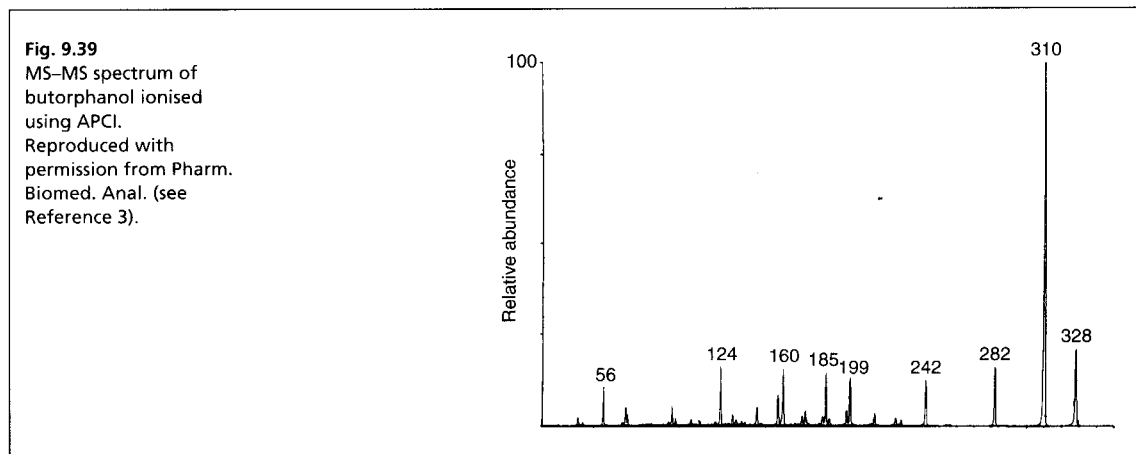
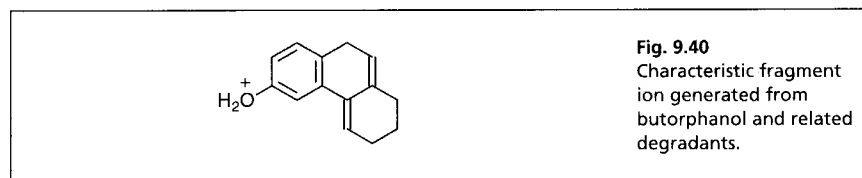

Figure 9.39 shows the APCI MS–MS spectrum of butorphanol, where additional fragmentation of the molecule was produced in a collision cell as an aid to identification.



Some of the ions present in butorphanol shown in Figure 9.39 can be explained by the following losses: 310 ($MH-H_2O$), 282 ($MH-H_2O-C_2H_4$) and 242 ($MH-H_2O-C_5H_9$). An ion at m/z 199 formed by rearrangement of the structure prior to fragmentation with loss of one of the rings was assigned the following structure (Fig. 9.40):



The fragment in Figure 9.40 was characteristic of the nucleus of the molecule and provided an important pointer in the elucidation of structure of the other degradants. By comparison with mass spectrum obtained for butorphanol, the degradants shown in Figure 9.41 were found to be present.

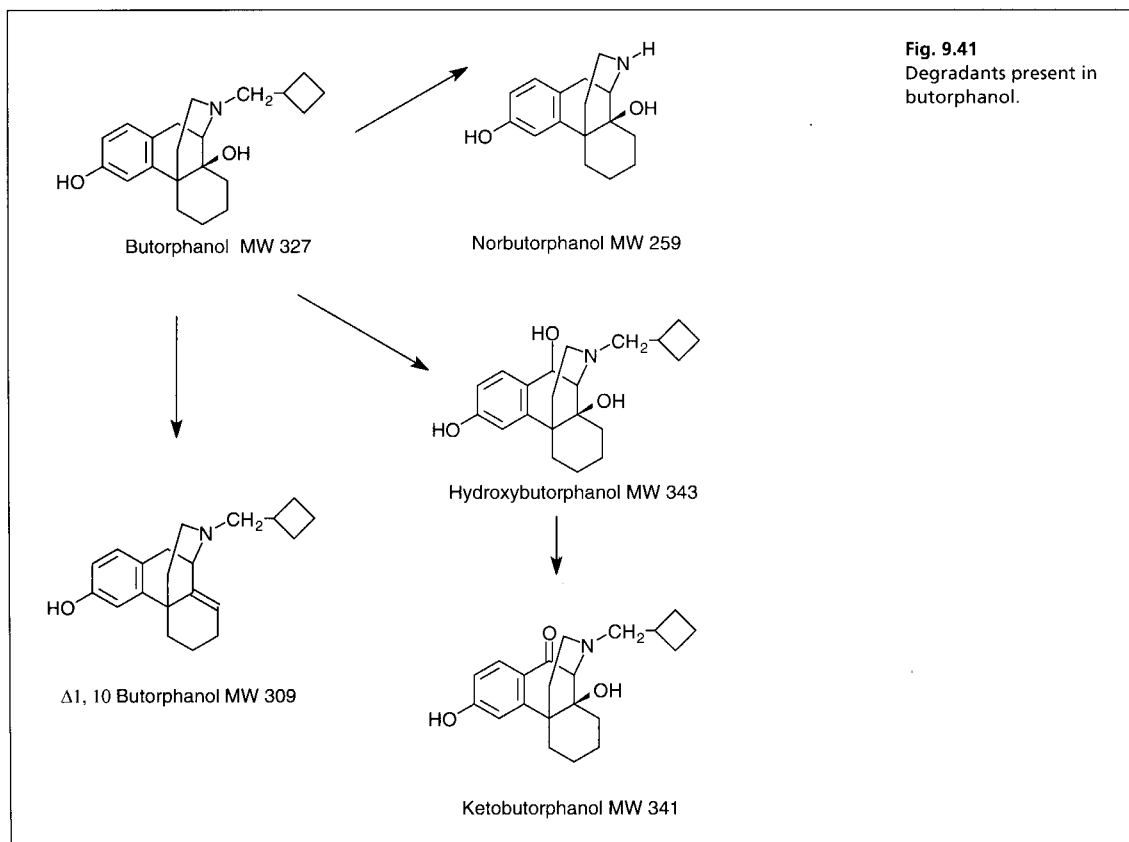

Fig. 9.41
Degradants present in
butorphanol.

References

1. L. Poulter, B.N. Green, S. Kaur and A.L. Burlingame. In: A.L. Burlingame and J.A. McCloskey, eds. *Biological Mass Spectrometry*. Elsevier Science Publishers, Amsterdam (1990).
2. Q. Xue-Qin, P.I.P. Dominic, K.H-C. Chang, P.M. Dradransky, M.A. Brooks and T. Sakuma. *J. Pharm. Biomed. Anal.* 12, 221–233 (1994).
3. K.J. Volk, S.E. Klohr, R.A. Rourick, E.H. Kerns and M.S. Lee. *J. Pharm. Biomed. Anal.* 14, 1663–1674 (1996).

Further reading

Practical Organic Mass Spectrometry: A Guide for Chemical and Biochemical Analysis, 2nd Edn.

J.R. Chapman, ed. Wiley Interscience, Chichester (1995).

Mass Spectrometry. R. Davis and M. Frearson, eds. John Wiley and Sons, Chichester (1994).

Mass Spectrometry for Chemists and Biochemists. Cambridge University Press, Cambridge (1996).

Spectroscopic Methods in Organic Chemistry, 4th Edn. D.H. Williams and I. Fleming, eds. McGraw Hill, London (1989).

10

Chromatographic theory

Introduction	Van Deemter equation in liquid chromatography	Resolution
Void volume and capacity factor	Van Deemter equation in gas chromatography	Peak asymmetry
Calculation of column efficiency	Parameters used in evaluating column performance	Data acquisition
Origins of band broadening in HPLC		Report generation

Introduction

Chromatography is the most frequently used analytical technique in pharmaceutical analysis. An understanding of the parameters which govern chromatographic performance has given rise to improvements in chromatography systems so that the ability to achieve high resolution separations is continually increasing. The system suitability tests which are described at the end of this chapter are now routinely included in chromatographic software packages so that the chromatographic performance of a system can be monitored routinely. The factors determining chromatographic efficiency will be discussed first in relation to high pressure liquid chromatography (HPLC).

Void volume and capacity factor

Figure 10.1 shows a HPLC column packed with a solid stationary phase with a liquid mobile phase flowing through it.

If a compound does not partition appreciably into the stationary phase, it will travel through the column at the same rate as the solvent. The length of time it takes an unretarded molecule to flow through the column is determined by the void volume of the column (V_o). The porous space within a silica gel packing is usually about 0.7 × the volume of the packing; a typical packing volume in a 0.46 × 15 cm column is ca 2.5 cm³. Thus in theory it should take solvent or unretarded molecules, flowing at a rate of 1 ml/min, ca 1.8 min to pass through the void volume of such a column (the internal space is likely to be reduced where the silica gel has been surface coated with stationary phase). The length of time it takes a retarded compound to pass through the column depends on its capacity factor (K'), which is a measure of the degree with which it partitions (adsorbs) into the stationary phase from the mobile phase:

$$K' = \frac{V_r - V_o}{V_o} \text{ or } \frac{t_r - t_o}{t_o}$$

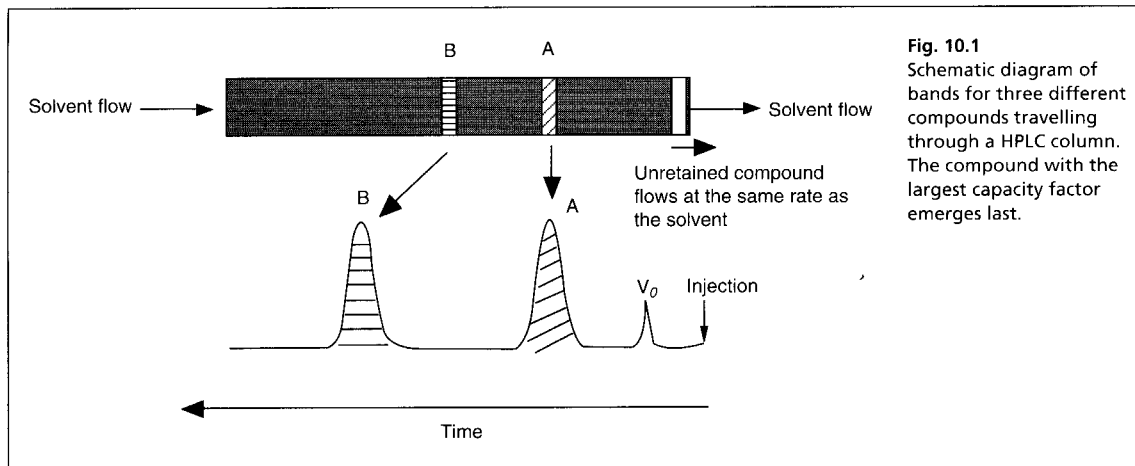

where V_0 is the void volume of the column, V_r is the retention volume of the analyte, t_0 is the time taken for an unretained molecule to pass through the void volume and t_r is the time taken for the analyte to pass through the column. In the example shown in Figure 10.1, compound B has a larger capacity factor than compound A. For example, if a compound had a K' of 4, the V_0 of a column was 1 ml and the solvent was flowing through the column at 1 ml/min, the total time taken for the compound to pass through the column would be 5 min, i.e. for the 1 min required to pass through the void space in the column 4 min would be spent in the stationary phase. This is a simplification of the actual process but it provides a readily understandable model. As can be seen in Figure 10.1 the peaks produced by chromatographic separation actually have width as well as a retention time and the processes which give rise to this width will be considered later.

Self-test 10.1

Calculate the time taken for the following compounds to emerge from a chromatographic column under the specified conditions.

K' of compound	V_0 of column (ml)	Solvent flow rate (ml/min)
6	1	1
10	1	2

Answers: 7 min and 5 min

Calculation of column efficiency

The broader a chromatographic peak is relative to its retention time the less efficient the column it is eluting from. Figure 10.2 shows a chromatographic peak emerging at time t_r after injection; the efficiency of the column is most readily assessed from the width of the peak at half its height $W_{1/2}$ and its retention time using Equation 1:

Equation 1
$$n = 5.54 (t_r/W_{1/2})^2$$

where n is the number of theoretical plates.

Column efficiency is usually expressed in theoretical plates per metre:

Fig. 10.2
Determination of retention time and peak width at half height.

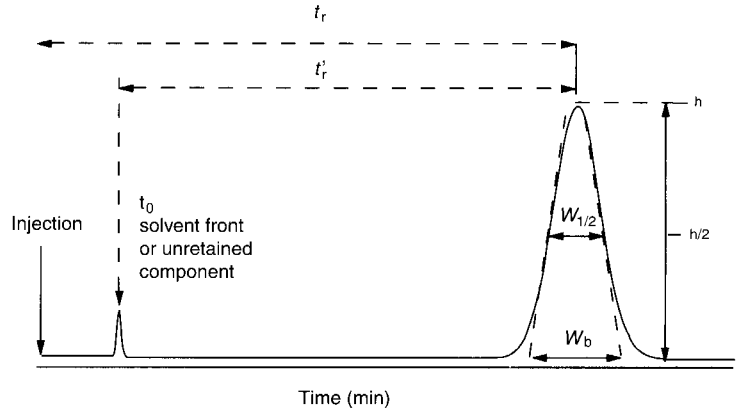

$$n \times 100/L$$

where L is the column length in cm.

A stricter measure of column efficiency, especially if the retention time of the analyte is short, is given by equation 2:

Equation 2
$$N_{eff} = 5.54 (t'_r/W_{1/2})^2$$

where N_{eff} is the number of effective plates and reflects the number of times the analyte partitions between the mobile phase and the stationary phase during its passage through the column and $t'_r = t_r - t_0$.

Another term which is used as a measure is H , the 'height of a theoretical plate':

$$H = L/N_{eff}$$

where H is the length of column required for one partition step to occur.

Self-test 10.2

A standard operating procedure states that a column must have an efficiency > 30 000 theoretical plates/m. Which of these 15 cm columns meets the specification?

Retention time of analyte (min)	$W_{1/2}$ (min)
1. 6.4	0.2
2. 5.6	0.2
3. 10.6	0.6

Answer: Column 1

Origins of band broadening in HPLC

Van Deemter equation in liquid chromatography

Chromatographic peaks have width and this means that molecules of a single compound, despite having the same capacity factor, take different lengths of time to travel through the column. The longer an analyte takes to travel through a column, the more the individual molecules making up the sample spread out and the broader

the band becomes. The more rapidly a peak broadens the less efficient the column. Detailed mathematical modelling of the processes leading to band broadening is very complex.¹ The treatment below gives a basic introduction to the origins of band broadening. The causes of band broadening can be formalised in the Van Deemter equation (Equation 3) as applied to liquid chromatography:

Equation 3
$$H = \frac{A}{1 + C_m u^{1/2}} + \frac{B}{u} + C_s u + C_m u^{1/2}$$

H is the measure of the efficiency of the column (discussed above); the smaller the term the more efficient the column.

u is the linear velocity of the mobile phase; simply how many cm/s an unretained molecule travels through the column and A is the 'eddy' diffusion term; broadening occurs because some molecules take longer erratic paths while some, for instance those travelling close to the walls of the column, take more direct paths thus eluting first. As shown in Figure 10.3, for two molecules of the same compound, molecule X elutes before molecule Y. In liquid chromatography the eddy diffusion term also contains a contribution from streaming within the solvent volume itself, i.e. A (see the C_m term) is reduced if the diffusion coefficient of the molecule within the mobile phase is low because molecules take less erratic paths through not being able to diffuse out of the mainstream so easily.

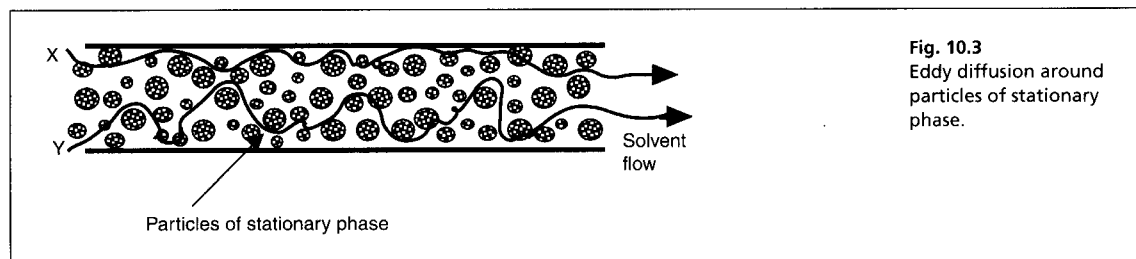

Fig. 10.3
Eddy diffusion around particles of stationary phase.

B is rate of diffusion of the molecule in the liquid phase which contributes to peak broadening through diffusion either with or against the flow of mobile phase; the contribution of this term is very small in liquid chromatography. Its contribution to band broadening decreases as flow rate increases and it only becomes significant at very low flow rates.

C_s is the resistance to mass transfer of a molecule in the stationary phase and is dependent on its diffusion coefficient in the stationary phase and upon the thickness of the stationary phase coated onto silica gel:

$$C_s = \frac{d^2 \text{ thickness}}{D_s}$$

where d^2 thickness is the square of the stationary phase film thickness and D_s is the diffusion coefficient of the analyte in the stationary phase.

Obviously the thinner and more uniform the stationary phase coating, the smaller the contribution to band broadening from this term. In the example shown in Figure 10.4, molecule Y is retarded more than molecule X. It could be argued that this effect evens out throughout the length of the column, but in practice the number of random partitionings during the time required for elution is not sufficient to eliminate it. As might be expected, C_s makes less contribution as u decreases.

Fig. 10.4
Resistance to mass transfer of a molecule within a particle of stationary phase.

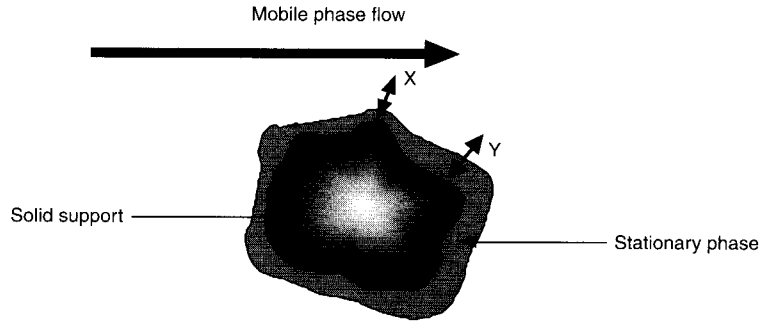

C_m is resistance to mass transfer brought about by the diameter and shape of the particles of stationary phase and the rate of diffusion of a molecule in the mobile phase.

$$C_m = \frac{d^2 \text{ packing}}{D_m}$$

where d^2 packing is the square of the stationary phase particle diameter and D_m is the diffusion coefficient of the analyte in the mobile phase.

The smaller and more regular the shape of the particles of stationary phase, the smaller the contribution to band broadening from this term. In Figure 10.5 molecule X is retarded more than molecule Y both in terms of pathlength (this really belongs to the eddy diffusion term) and contact with stagnant areas of solvent within the pore structure of the stationary phase. With regard to the latter effect, the smaller the rate of diffusion of the molecular species (D_m) in the mobile phase, the greater the retardation will be. There are an insufficient number of random partitionings during elution for these effects to be evened out.

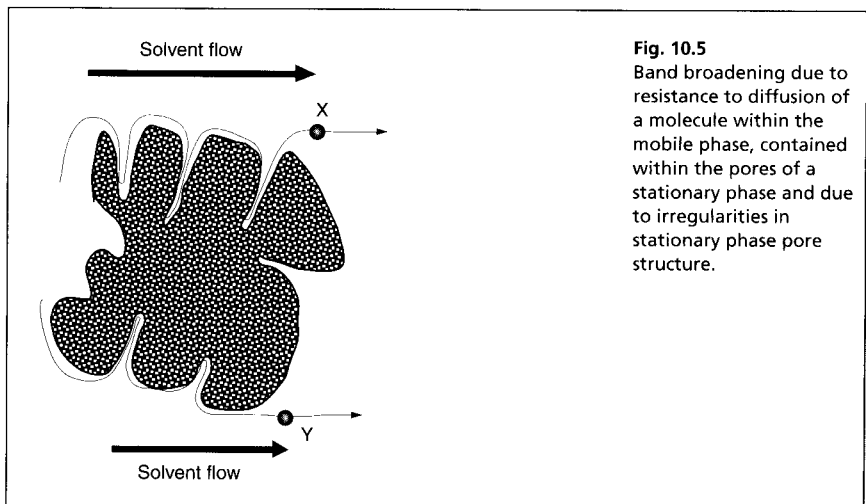

Fig. 10.5
Band broadening due to resistance to diffusion of a molecule within the mobile phase, contained within the pores of a stationary phase and due to irregularities in stationary phase pore structure.

Thus, a low diffusion coefficient for the analyte in the mobile phase increases efficiency with regard to the A term but decreases efficiency with respect to the C_m term. On balance, a higher diffusion coefficient is more favourable. Higher column temperatures reduce mass transfer effects because the rate of diffusion of a molecule in the mobile phase increases.

In practice the contributions of the A , $C_s u$ and $C_m u^{1/2}$ terms to band broadening are similar except at very high flow rates where the $C_s u$ terms predominate. At very low flow rates, the B term makes more of a contribution. A compromise has to be reached between analysis time and flow rate. Advances in chromatographic techniques are based on the minimisation of the effects of the various terms in the Van Deemter equation and it has provided the rationale for improvements in the design of stationary phases.

Self-test 10.3

Indicate which of the following parameters can decrease or increase column efficiency in liquid chromatography.

- Very low flow rate
- Large particle size of stationary phase
- Small particle size of stationary phase
- Thick stationary phase coating
- Thin stationary phase coating
- Regularly shaped particles of stationary phase
- Irregularly shaped particles of stationary phase
- High temperature
- Low temperature
- Uneven stationary phase coating
- Even stationary phase coating
- Uniform stationary phase particle size
- Non-uniform stationary phase particle size
- Low diffusion coefficient in the mobile phase
- High diffusion coefficient in the mobile phase
- Low diffusion coefficient in the stationary phase
- High diffusion coefficient in the stationary phase.

Answers: Decreases column efficiency: very low flow rate; large particle size of stationary phase; thick stationary phase coating; irregularly shaped particles of stationary phase; low temperature; uneven stationary phase coating; non-uniform stationary phase particle size; low diffusion coefficient in the mobile phase; high diffusion coefficient in the stationary phase. Increases column efficiency: small particle size of stationary phase; thin stationary phase coating; regularly shaped particles of stationary phase; high temperature; even stationary phase coating; uniform stationary phase particle size; high diffusion coefficient in the mobile phase.

Van Deemter equation in gas chromatography

The Van Deemter equation can be applied to gas chromatography with a different emphasis on the relative importance of its terms. In fact, the interactions between an analyte and a stationary phase are much simpler in gas chromatography than those in liquid chromatography since the mobile phase does not modify the stationary phase in any way. The theoretical considerations are different for packed GC columns vs open tubular capillary columns.

In gas chromatography the Van Deemter equation can be written as:

$$H = A + \frac{B}{u} + Cu$$

where H is the measure of column efficiency, A is the eddy diffusion coefficient B is $2 \times$ the diffusion coefficient of the analyte in the gas phase, C is composed of terms relating to the rate of diffusion of the analyte in the gas and liquid phases (mass transfer, see above) and u is the carrier gas velocity.

For an open tubular capillary column (Fig. 10.6) the eddy diffusion coefficient does not play a part in band broadening and the C term is largely composed of the transverse diffusion coefficient in the gas phase since the liquid film coating of the capillary column wall is typically 0.1–0.2% of the internal diameter of the column. B/u is most favourable for nitrogen (diffusion coefficients of molecules are lower in nitrogen than in the other commonly used carrier gases hydrogen and helium). However, nitrogen only gives better efficiency where u is small since the size of the term Cu is governed by the resistance to transverse diffusion which is greatest for nitrogen, i.e. fast flow rates of nitrogen reduce the interaction of the analyte with the stationary phase. Most often helium is used as a carrier gas in capillary GC since it gives a good efficiency without having to reduce the flow rate, which would give long analysis times. Transverse diffusion effects are reduced by reducing the internal diameter of a capillary column and thus the smaller the internal diameter of a column, the more efficient it is.

Fig. 10.6
Band broadening factors
in open tubular columns.

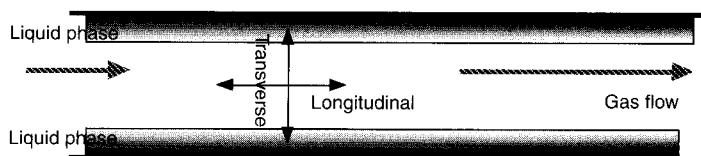

With a packed GC column the separation efficiency is lower because, although the longitudinal diffusion coefficient is lower, the eddy diffusion coefficient (A) causes band broadening (Fig. 10.3). In addition, mass transfer effects are greater for a packed column because of the irregular structure of the particles of packing and the consequent uneven coating of a relatively thick liquid phase. However, whatever type of GC column is used, the C_m term is not as significant as that in liquid chromatography because of the high diffusion coefficient of molecules in the gas phase.

Parameters used in evaluating column performance

Having optimised the efficiency of a chromatographic separation the quality of the chromatography can be controlled by applying certain system suitability tests. One of these is the calculation of theoretical plates for a column and there are two other main parameters for assessing performance: peak symmetry and the resolution between critical pairs of peaks. A third performance test, the peak purity parameter, can be applied where two-dimensional detectors such as diode or coulometric array or mass spectrometry detectors are being used. The reproducibility of peak retention times is also an important parameter for controlling performance.

Resolution

The more efficient a column the greater degree of resolution it will produce between

closely eluting peaks. The resolution between two peaks – A and B (Fig. 10.7) is expressed in Equation 4:

$$\text{Equation 4} \quad R_s = 2(t_{rB} - t_{rA})/W_{bB} + W_{bA}$$

where t_{rB} and t_{rA} are the retention times of peaks A and B and W_{bB} and W_{bA} are the widths of peaks A and B at baseline. An R_s of 1 indicates a separation of 4σ between the apices of two peaks. Complete separation is considered to be $R_s = 1.2$. The retention times of peaks A and B are 26.3 and 27.2 min respectively. The substitution of these values and the values obtained for peak widths at base for A and B into Equation 4 is as follows:

$$R_s = \frac{2(27.2 - 26.3)}{0.56 + 0.56} = 1.6$$

It is obvious without calculation that peaks A and B are well resolved. With incomplete separation, the determination of resolution is more difficult since the end and beginning of the two partially overlapping peaks has to be estimated; if the peak shape is good it is easiest to assume the same symmetry for the leading and tailing edges of the two peaks. If this is carried out for peaks B and C in Figure 10.7, their resolution is found to be 0.85, which is not an entirely satisfactory resolution. More is required of the integrator which is used to measure peak areas when peaks overlap since it must be able to decide where one peak ends and the other begins. Ideally peak overlap should be avoided for quantitative accuracy and precision.

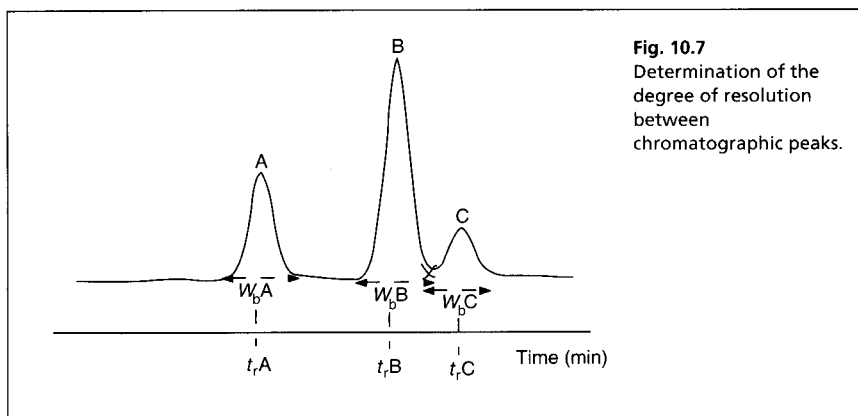

Self-test 10.4

The BP assay of betamethasone 17-valerate states that it must be resolved from betamethasone 21-valerate so that the resolution factor is > 1.0 . Which of the following ODS columns meet the specification?

Retention time of betamethasone 21-valerate (min)	Retention time of betamethasone 17-valerate (min)	Width at base of bet 21-valerate (min)	Width at base of bet 17-valerate (min)
1. 9.5	8.5	0.4	0.5
2. 9.3	8.6	0.4	0.4

Answer: 1 and 2

Peak asymmetry

Another situation which may lead to poor integrator performance is where peaks are tailing and thus have a high element of asymmetry. The expression used to assess this is:

$$\text{Asymmetry factor (AF)} = b/a$$

where a is the leading half of the peak measured at 10% of the peak height and b is the trailing half of the peak measured at 10% of the peak height (Fig. 10.8). This value should fall, ideally, in the range 0.95–1.15. Poor symmetry may be caused through: loading too much sample onto the column, sample decomposition, the analyte adsorbing strongly onto active sites in the stationary phase, poor trapping of the analyte when it is loaded onto the column or too much 'dead volume' in the chromatographic system.

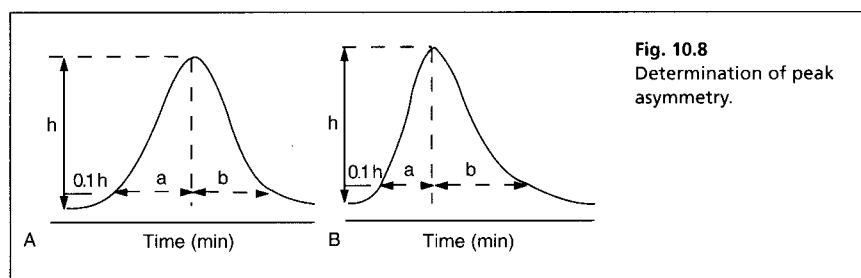

The peak in Figure 10.8A has an asymmetry factor of 0.97 and this is due to its tailing slightly at the front edge; this may be due to inefficient trapping of the sample at the head of the column as it is loaded. The peak in Figure 10.8B has an asymmetry factor of 1.77 and is thus tailing quite badly; the most common cause of tailing is due to adsorption of the analyte onto active sites in the chromatographic column.

Data acquisition

An integrator, whether it is based on a microprocessor or PC software, simply measures the total amount of current which flows over the width of a chromatographic peak. To do this it measures the rate of increase of voltage approximately 30 times across the width of the peak. The parameter which indicates when measurement should start is the peak threshold which determines the level that the voltage of the signal should rise to before accumulation of the signal will occur. To avoid storage of baseline drift the peak width parameter is linked to the peak threshold parameter, which indicates that if the signal rises above baseline the slope of the rise should have a certain steepness before it is regarded as a peak. A narrow peak width setting indicates that the expected slope should be steep and a wide peak width setting indicates that the expected slope should be relatively shallow. For good digital recording a peak should be sampled *ca* 30 times across its width. The setting relates to the estimated width at half-height of peaks in a chromatogram, e.g. a width setting of 0.4 min would cover many HPLC applications. There is quite a wide degree of tolerance in the peak width setting although it should be set within $\pm 100\%$ of the expected peak width at half-height to ensure accurate peak integration.

A factor which can cause a loss of precision in chromatographic quantification is the reproducibility of the way in which peaks are integrated. If peaks have good symmetry, are well resolved from neighbouring peaks and are well above baseline noise, integration is likely to be reproducible. The peak threshold (PT) setting has the greatest effect on peak area and it has to be set high enough for fluctuations in the baseline to be ignored. In the example shown in Figure 10.9, in the first case the threshold is set too low and a tail of baseline drift is attached to the peak during integration. In the second case, the threshold is set higher and the tail is ignored. The area of peak A determined with a peak threshold of $100\ \mu\text{V}$ is only 94% of the area determined for peak A with tailing baseline included at a threshold of $10\ \mu\text{V}$. This could make a significant difference to the precision of the analysis depending on how reproducibly the peak tail was integrated. This type of effect is only likely to be significant if the size of the peaks is low in relation to baseline fluctuations.

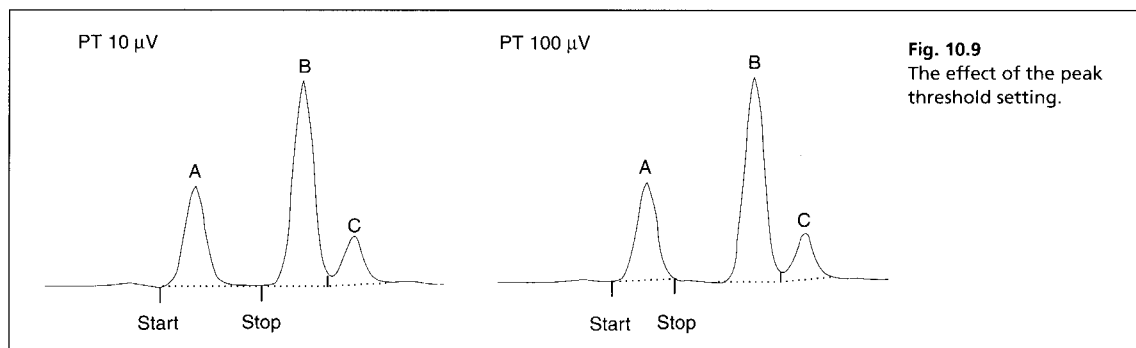

Fig. 10.9
The effect of the peak threshold setting.

The two fused peaks shown in Figure 10.9 are not as affected by a change in the peak threshold setting, however, their areas can only be approximated because of their overlap. It is possible by setting the integrator to produce a tangent skim to change the way in which these peaks are integrated as shown in Figure 10.10. In this instance where the peaks are almost resolved and are not vastly different in height, the integration method used in Figure 10.9 probably gives a better approximation of the areas.

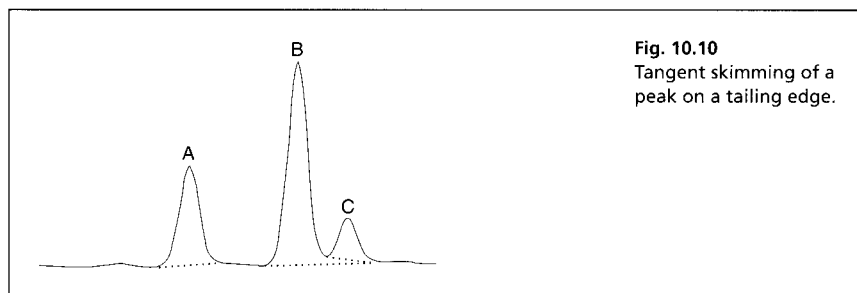

Fig. 10.10
Tangent skimming of a peak on a tailing edge.

Report generation

Computerised data handling systems will generate reports including a number of system suitability parameters. Figure 10.11 shows a chromatogram with a report form appended. In order for the report to be generated, the computer has to be given

some information, e.g. the expected retention times of peaks for which resolution factors have to be measured and the retention time of an unretained peak in order to determine capacity factor. With increasing dependence on computers, it is important to be able to guesstimate whether the computer is generating sensible data; the ability to calculate the various efficiency parameters from first principles is an important check on the performance of the integrator.

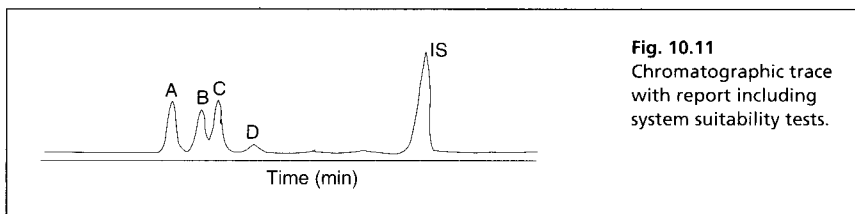

Fig. 10.11
Chromatographic trace
with report including
system suitability tests.

Component	Retention time	Area %	n per column	AF	$W_{1/2}$ min	R_s	K'
A	20.1	16.3	50 166	0.96	0.2	–	18.3
B	20.8	13.2	65 229	0.87	0.2	1.4	18.9
C	21.2	15.5	81 189	1.13	0.17	0.81	19.2
D	22.0	2.21	44 397	0.99	0.23	1.8	20.0
IS	25.7	37.9	64 316	0.75	0.23	–	23.4

Reference

1. J.C. Giddings. Unified separation science. Wiley Interscience, Chichester (1991).

11

Gas chromatography

Keypoints	Carrier gas type/flow	Determination of pivalic acid in dipivefrin eye drops
Introduction	Column temperature	Determination of Dimethylaniline in bupivacaine injection BP
Instrumentation	Column length	Determination of a residual glutaraldehyde in a polymeric film
Syringes	Film thickness phase loading	
Injection systems	Internal diameter	
GC oven	GC detectors	
Types of column	Applications of GC in quantitative analysis	Determination of residual solvents
Selectivity of liquid stationary phases	Analysis of methyltestosterone in tablets	Typical BP procedures
Kovats indices and column polarity	Analysis of atropine in eyedrops	Determination of residual solvents and volatile impurities by head space analysis
Examples of the separation of mixtures by GC	Quantification of ethanol in a formulation	Purge trap analysis
Use of derivatisation in GC	Determination of manufacturing and degradation residues by GC	Applications of GC in bioanalysis
Summary of parameters governing capillary GC performance		Additional problems

KEYPOINTS

Principles

A gaseous mobile phase flows under pressure through a heated tube either coated with a liquid stationary phase or packed with liquid stationary phase coated onto a solid support. The analyte is loaded onto the head of the column via a heated injection port where it evaporates. It then condenses at the head of the column, which is at a lower temperature. The oven temperature is then either held constant or programmed to rise gradually. Once on the column separation of a mixture occurs according to the relative lengths of time spent by its components in the stationary phase. Monitoring of the column effluent can be carried out with a variety of detectors.

Applications

- The characterisation of some unformulated drugs, particularly with regard to detection of process impurities.
- Limit tests for solvent residues and other volatile impurities in drug substances.
- Sometimes used for quantification of drugs in formulations, particularly if the drug lacks a chromophore.

- Characterisation of some raw materials used in synthesis of drug molecules.
- Characterisation of volatile oils (which may be used as excipients in formulations), proprietary cough mixtures and tonics, and fatty acids in fixed oils.
- Measurement of drugs and their metabolites in biological fluids.

Strengths

- Capable of the same quantitative accuracy and precision as high-pressure liquid chromatography (HPLC), particularly when used in conjunction with an internal standard.
- Has much greater separating power than HPLC when used with capillary columns.
- Readily automated.
- Can be used to determine compounds which lack chromophores.
- The mobile phase does not vary and does not require disposal and, even if helium is used as a carrier gas, is cheap compared to the organic solvents used in HPLC.

Limitations

- Only thermally stable and volatile compounds can be analysed.
- The sample may require derivatisation to convert it to a volatile form, thus introducing an extra step in analysis and, potentially, interferants.
- Quantitative sample introduction is more difficult because of the small volumes of sample injected.
- Aqueous solutions and salts cannot be injected into the instrument.

Introduction

The use of gas chromatography (GC) as a quantitative technique in the analysis of drugs has declined in importance since the advent of HPLC and the increasing sophistication of this technique. However, it does still have a role in certain types of quantitative analysis and has broad application in qualitative analysis. Since HPLC currently dominates quantitative analyses in the pharmaceutical industry, the strengths of GC may be overlooked. Capillary GC is capable of performing much more efficient separations than HPLC albeit with the limitation that the compounds being analysed must be volatile or must be rendered volatile by formation of a suitable derivative¹ and must also be thermally stable. GC is widely used in environmental science, brewing, the food industry, perfumery and flavourings analysis, the petrochemical industry, microbiological analyses and clinical biochemistry. Although packed column GC is still used in the pharmaceutical industry, this chapter will concentrate to a large extent on open tubular capillary GC, which is the more modern manifestation of GC.

Instrumentation

Figure 11.1 shows a schematic diagram of a GC system. The principles of the system are that:

- (i) Injection of the sample may be made manually or using an autosampler through a resealable rubber septum.
- (ii) The sample is evaporated in the heated injection port area and condenses on the head of the column.
- (iii) The column may either be a capillary or a packed column, which will be discussed in more detail later. The mobile phase used to carry the sample through the column is a gas – usually nitrogen or helium.
- (iv) The column is enclosed in an oven which may be set at any temperature between ambient and *ca* 400°C.
- (v) The most commonly used detector is the flame ionisation detector (FID).

Fig. 11.1
Schematic diagram of a
capillary GC system.

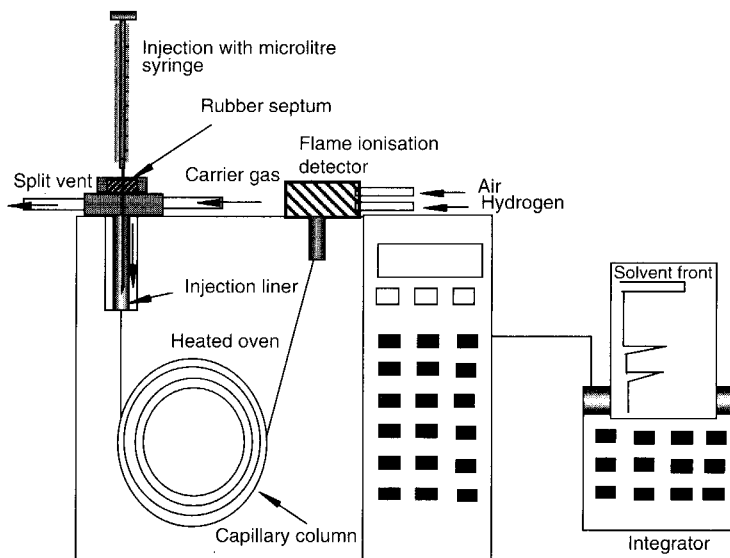

Syringes

The volumes injected in GC are routinely in the range of $0.5\text{--}2\ \mu\text{l}$. The most commonly used type of syringe is shown in Figure 11.2; the usual syringe volumes are 5 and $10\ \mu\text{l}$. A recommended technique for injection into a capillary GC is to fill the syringe with about $0.5\ \mu\text{l}$ of solvent and draw this solvent into the barrel slightly before filling with sample. The sample is also drawn into the barrel to leave an air gap below it. The syringe needle can then be introduced into the injector and left for a couple of seconds to warm up before the plunger is depressed. The syringe is then withdrawn immediately from the injection port.

Fig. 11.2
 $10\ \mu\text{l}$ sample in barrel
syringe.

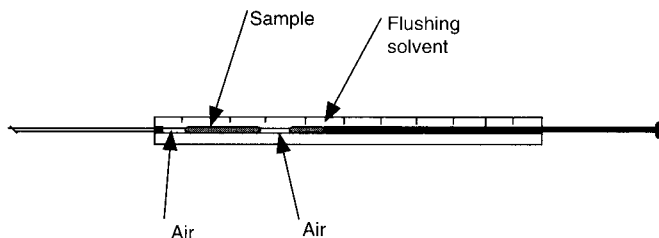

Injection systems

Packed column injections

Injection generally occurs through a resealable rubber septum. The injector port is held at $150\text{--}250^\circ$ depending on the volatility of the sample and direct injection of $0.1\text{--}10\ \mu\text{l}$ of sample is made onto the head of the column. The amount of sample injected onto a packed column is *ca* $1\text{--}2\ \mu\text{g}$ per component. Injection into packed

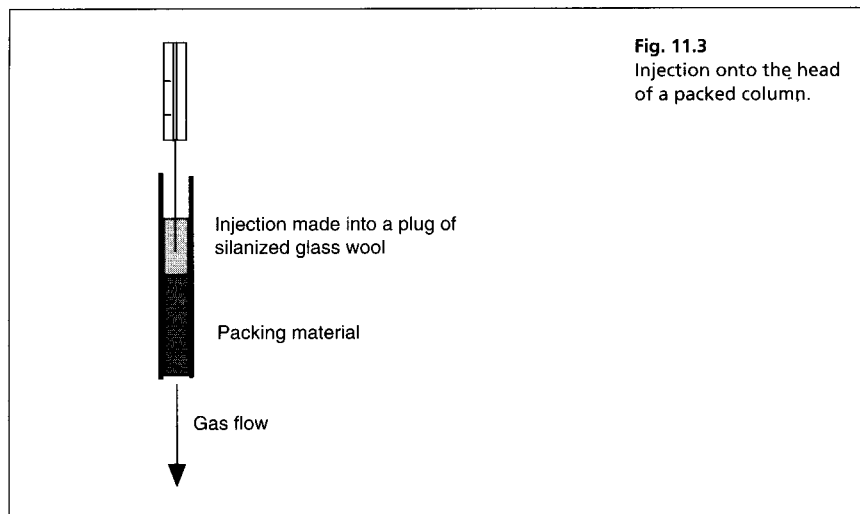

Fig. 11.3
Injection onto the head
of a packed column.

columns presents less of a problem than sample introduction into a capillary column since all of the sample is introduced into the packed column (Fig. 11.3). Thus, although packed columns do not produce high resolution chromatography, this is their strength.

Split/splitless injection

This type of injector is used in conjunction with capillary column GC. Capillary columns commonly have internal diameters between 0.2 and 0.5 mm and lengths between 12 and 50 m. Injection takes place into a heated glass or quartz liner rather than directly onto the column.

In the split mode, the sample is split into two unequal portions the smaller of which goes onto the column. Split ratios range between 10:1 and 100:1, with the larger portion being vented in the higher flow out of the split vent. This technique is used with concentrated samples. In the splitless mode, all of the sample is introduced onto the column and the injector purge valve remains closed for 0.5–1 min after injection. The difficulty faced with split/splitless injection onto a capillary column is in obtaining good injection precision.² Attention has to be paid to certain points:

- (i) Since injection is made at high temperatures into an injection port, a lack of precision resulting from decomposition of some of the components in a mixture before they reach the column has to be considered. Thus it is important to ensure that the sample has minimal contact with metal surfaces during the injection process since these can catalyse decomposition.
- (ii) If a split injection is used, care has to be taken that there is no discrimination between more and less volatile components in a mixture in terms of the proportion lost through the split vent.
- (iii) If a splitless injection is made, volumes have to be kept below *ca* 2 μl in case the sample backflashes through rapid expansion of the solvent in which it is dissolved, into either the gas supply lines or the purge lines. Each 1 μl of solvent expands greatly upon vapourisation, e.g. methanol *ca* 0.66 ml/ μl or ethyl acetate *ca* 0.23 ml/ μl at atmospheric pressure.
- (iv) Even if an internal standard (p. 259) is used to compensate for losses, the possibility of it being discriminated randomly against either through differences in volatility or decomposition compared to the sample has to be considered.

- (v) In the splitless mode the sample must be efficiently trapped at the head of the column. For this to occur, it must be sufficiently involatile, i.e. have a boiling point $> ca$ 50°C higher than the column starting temperature. If the sample is relatively volatile it has to be injected into the GC in a low volatility solvent which will condense at the head of the column, trapping the sample in the process.
- (vi) Sample transfer may be slow and it is important to take this into account when setting purge valve times, e.g. for a typical 1 ml/min flow of helium through a capillary column, about 0.5 min would be required to transfer a $2\text{ }\mu\text{l}$ injection volume of ethyl acetate onto the column.
- (vii) Injection precision is greatly improved by the use of an autosampler to carry out injection since it can achieve much better precision in measuring volumes of ca $1\text{ }\mu\text{l}$ than a human operator.

Cool on-column injection

Direct on-column injection into the capillary column may be carried out in a manner analogous to injection into a packed column. This technique requires a syringe with a very fine fused silica needle. The technique has the advantages of: (1) reduced discrimination between components in mixtures; (2) no sample degradation in a hot injector; and (3) no backflash, hence quantitative sample transfer. It also has the following disadvantages: (1) samples have to be clean otherwise residues will be deposited on the column; (2) the injector is mechanically more complex and requires more maintenance than a septum injection system; and (3) the syringe needle may damage the head of the column.

GC oven

GC ovens incorporate a fan which ensures uniform heat distribution throughout the oven. They can be programmed to either produce a constant temperature, isothermal conditions or a gradual increase in temperature. Oven programming rates can range from 1°C/min to 40°C/min . Complex temperature programmes can be produced involving a number of temperature ramps interspersed with periods of isothermal conditions, e.g. 60°C (1 min)/ 5°C/min to 100°C (5 min)/ 10°C/min to 200°C (5 min). The advantages of temperature programmes are that materials of widely differing volatilities can be separated in a reasonable time and also injection of the sample can be carried out at low temperature where it will be trapped at the head of the column and then the temperature can be raised until it elutes.

Types of column

Packed columns

The columns are usually made from glass which is silanized to remove polar silanol Si-OH groups from its surface that can contribute to the peak tailing of the peaks of polar analytes. These columns have internal diameters of $2\text{--}5\text{ mm}$. The columns are packed with particles of a solid support which are coated with the liquid stationary phase. The most commonly used support is diatomaceous earth (mainly calcium silicate). This material is usually acid washed to remove mineral impurities and then silanized as shown in Figure 11.4 to remove the polar Si-OH groups on the surface of the support, which can lead to tailing of the analyte peak.

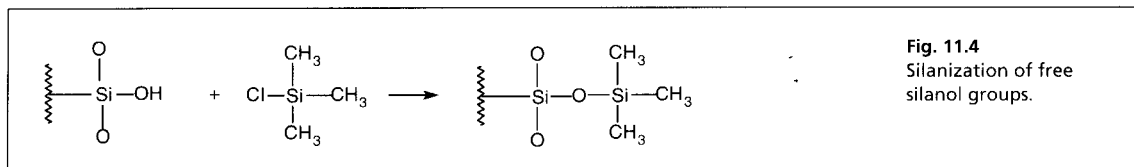

Fig. 11.4
Silanization of free
silanol groups.

The support can then be mechanically coated with a variety of liquid stationary phases. The mobile phase most commonly used in packed column GC is nitrogen with a flow rate of *ca* 20 ml/min. Packed column GC affords a relatively low degree of resolution compared to capillary GC; typically 4000–6000 plates for a 2 m column compared to > 100 000 plates for a 25 m capillary column. The high temperature limit of packed columns is *ca* 280°C; beyond this temperature the liquid stationary phase evaporates at a rate which creates a large background signal. However, for many routine quality control operations, they are quite adequate.

Capillary columns

Capillary columns are made from fused silica, usually coated on the outside with polyamide to give the column flexibility. Coating on the outside with aluminium has also been used for high temperature (> 400°C) work. The internal diameter of the columns ranges between 0.15 and 0.5 mm. The wall of the column is coated with the liquid stationary phase, which may have a thickness between 0.1 and 5 μm . The most common type of coating is based on organo silicone polymers, which are chemically bonded to the silanol groups on the wall of the column and the chains of the polymers are further cross-linked. These types of phases have more or less replaced the wall-coated open tubular (WCOT) and support-coated open tubular (SCOT) columns, which are reported in earlier literature, for most routine applications. SCOT columns are sometimes encountered in very high temperature work. The wall-bonded phases are stable to at least 325°C and some types of coating will withstand temperatures of 370°C. The non-silicone based polymers, e.g. carbowax, cannot be bonded onto the wall of the column in the same way and columns with these coatings are less temperature stable. For instance, the temperature limit for a carbowax capillary column is *ca* 240°C. The most commonly used carrier gas in capillary GC is helium and the flow rates used are between 0.5 and 2 ml/min. Since the flow rate from the end of the capillary column is low compared to the internal space of some detectors, 'make up' gas often has to be added to the gas flow post column in order to sweep the sample through the internal volume of the detector at a reasonable rate. Typically *ca* 100 ng per component is loaded onto a capillary column.

Selectivity of liquid stationary phases

Kovats indices and column polarity

Kovats indices (*I*-values) are based on the retention time of an analyte compared to retention times of the series of *n*-alkanes. For a particular GC phase, *I*-values are very reproducible from one column or from one GC to another. However, they are slightly affected by GC programming conditions. *n*-Alkanes have most affinity for non-polar phases and tend to elute more quickly from polar phases. In contrast, a polar analyte will elute more slowly from a polar phase and thus relative to the *n*-alkanes, its retention time and thus its *I*-value will increase as the polarity of the

GC phase increases. A measure of the polarity of a stationary phase is given by its McReynold's constant (Table 11.1), which is based on the retention times of benzene, *n*-butanol, pentan-2-one, nitropropane and pyridine on a particular phase. The higher the McReynold's constant the more polar the phase. Many stationary phases are described by an OV-number. The higher the number after the OV the more polar the phase.

Table 11.1 McReynold's constants

Phase	Chemical type	McReynold's constant
Squalane	Hydrocarbon	0
Silicone OV-1	Methylsilicone	222
Silicone SE-54	94% methyl, 5% phenyl, 1% vinyl	337
Silicone OV-17	50% methyl, 50% phenyl	886
Silicone OV-225	50% methyl, 25% cyanopropyl, 25% phenyl	1813
Carbowax	Polyethylene glycol	2318

I-values provide a useful method for characterising unknown compounds and tables of *I*-values have been compiled for a large number of compounds.³ Under temperature programming conditions, where the GC temperature rises at a uniform rate, e.g. 10°C/min, a plot of the carbon numbers of *n*-alkanes (where 1 carbon = 100) against their retention times is a straight line. Under isothermal conditions, where the column is maintained at the same temperature throughout the analysis, a plot of carbon number against the logarithm of the retention times of the *n*-alkanes is a straight line. Such calibration curves can be used to convert the retention time of a compound into an *I*-value.

Examples of the separation of mixtures by GC

Analysis of peppermint oil on two GC phases

Figure 11.5 shows the structures of some of the major components in peppermint oil. The use of the retention index system is illustrated in Figures 11.6 and 11.7 for peppermint oil run in comparison with *n*-alkane standards on both a weakly polar OV-5-type column and a polar carbowax column.

Figure 11.6 indicates approximate *I*-values for some of the components in peppermint oil on a BPX-5 column; this column selects mainly on the basis of molecular weight and shape. For example β -pinene has the same molecular weight as limonene but has a more compact shape and thus a lower *I*-value. Menthyl acetate has a higher *I*-value than menthol because of its higher molecular weight.

A carbowax column is highly selective for polar compounds. As can be seen in Figure 11.7 the group of polar compounds including menthol and menthone is

Fig. 11.5
The structures of some components in peppermint oil.

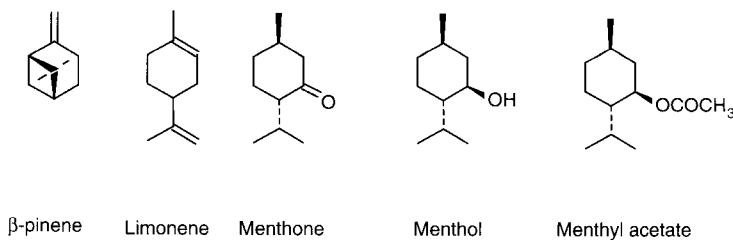

resolved more extensively on a carbowax column with the alcohol menthol and a number of other minor alcohols eluting at around 12 min. In addition, the less polar ketone menthone and a number of minor ketones elute at around 10 min. Menthyl acetate, which on the non-polar BPX-5 column ran later than menthol, runs earlier than menthol on the carbowax column because its polar alcohol group is masked by the acetate and it thus has a lower polarity than menthol.

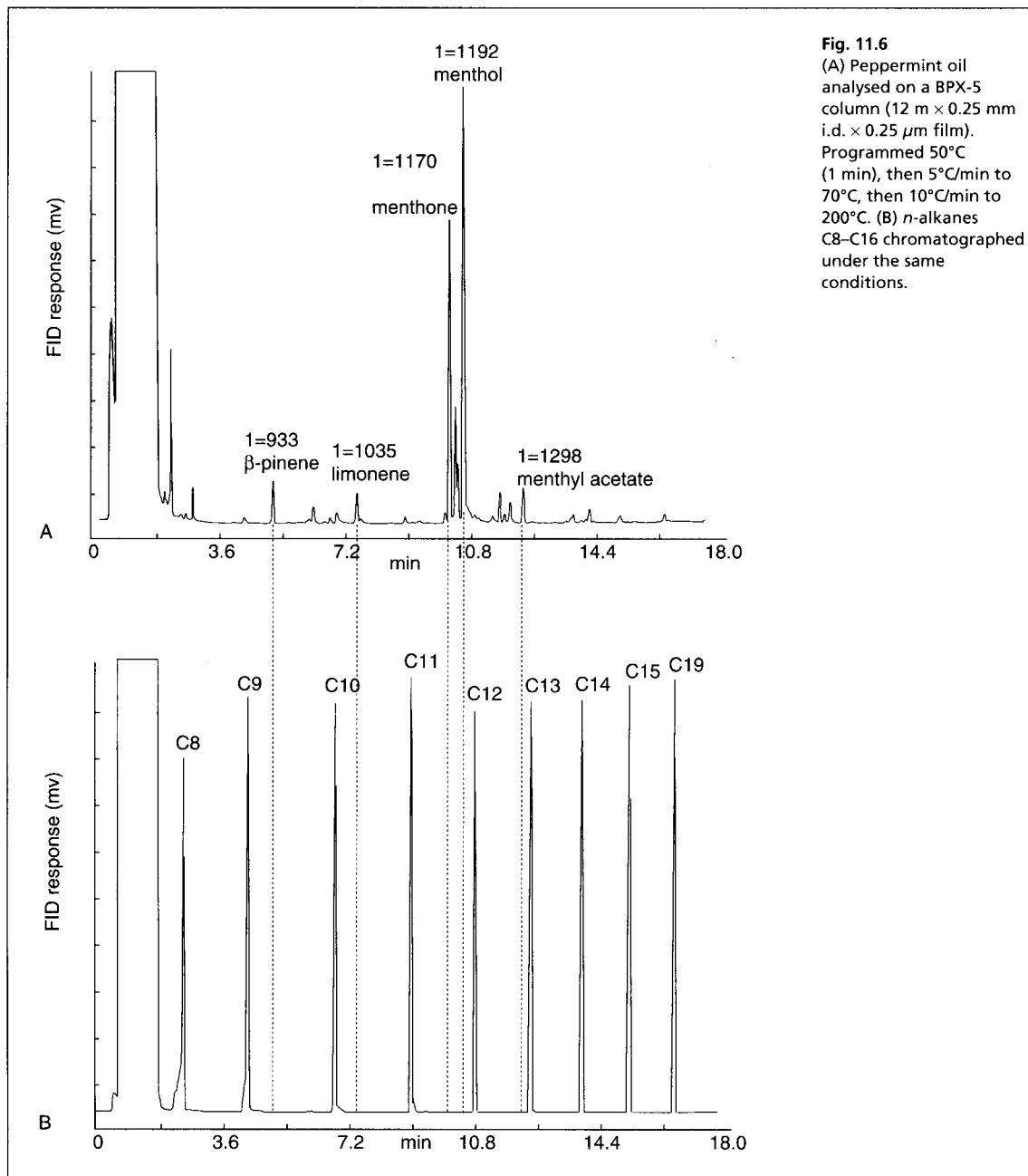
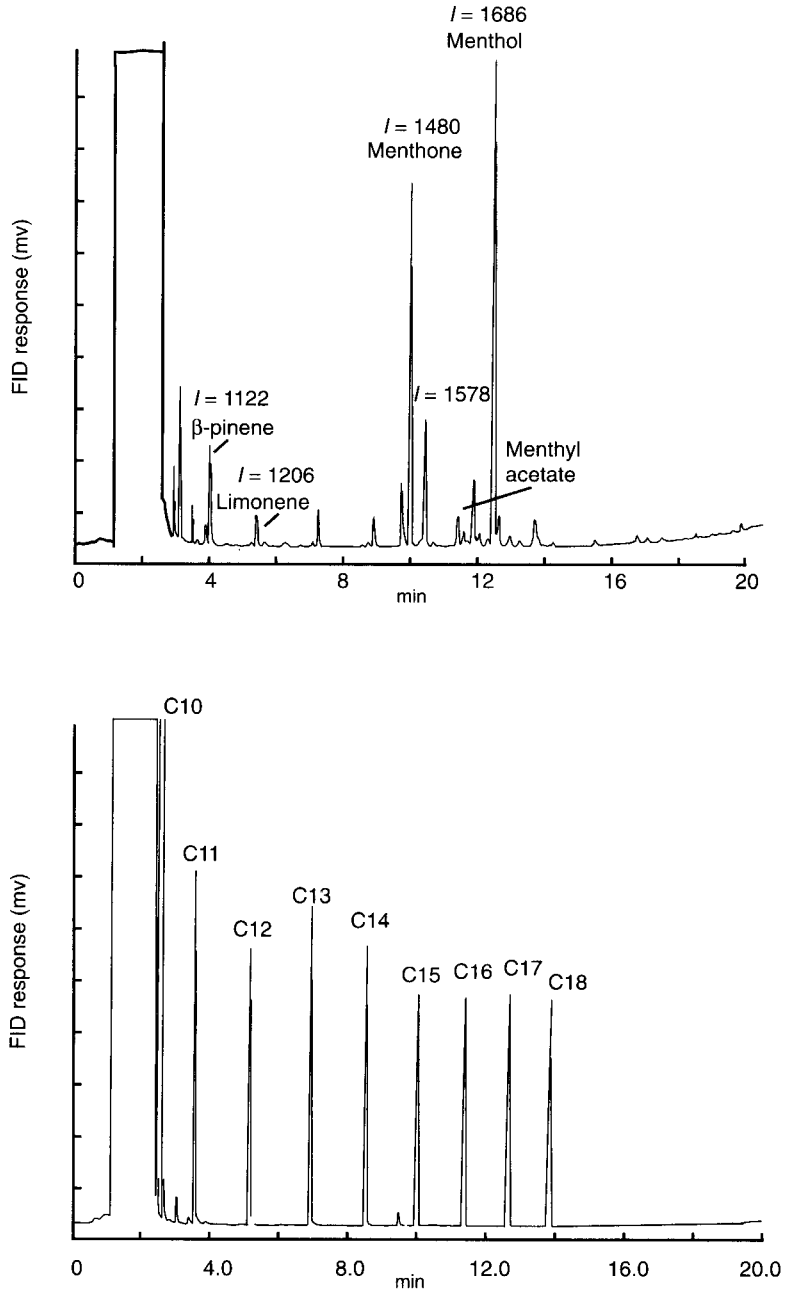

Fig. 11.7

(A) Peppermint oil analysed on a carbowax column (15 m × 0.25 mm × 0.5 μm film). Programmed 50°C (1 min) then 5°C/min to 70°C then 10°C/min to 200°C. (B) *n*-alkanes C10–C18 chromatographed under the same conditions.



Self-test 11.1

Associate the following *t*-values obtained on an OV-1-type column with structures of the local anaesthetics shown below. *t*-values: 1555, 2018, 2323 and 2457. Note: oxygen in an ether linkage is equivalent to ca 1 CH₂ unit.

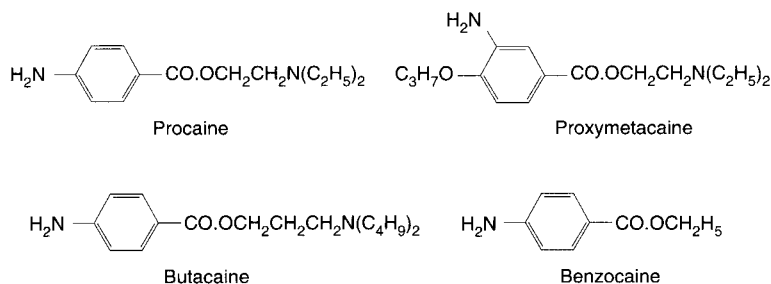

Answer: Procaine 2018; Proxymetacaine 2323; Butacaine 2457; Benzocaine 1555

Analysis of the fatty acid composition of a fixed oil by GC

A very polar phase such as carbowax is generally only used for samples requiring a high degree of polar discrimination for adequate separation or retention. An example of this is in the analysis of fatty acids with differing degrees of unsaturation. On a non-polar column such as BPX-5, a series of C-18 acids such as stearic, oleic, linoleic and linolenic acids, which contain respectively 0, 1, 2 and 3 double bonds, overlaps extensively. However, on polar columns such as carbowax they are separated.

The BP monographs for many of the fixed oils contain a GC analysis to confirm the content of the fatty acids composing the triglycerides (fatty acid triesters of glycerol) present in the oil. The monograph for almond oil states the composition of the fatty acids making up the triglyceride should be:

- palmitic acid (16:0) 4.0–9.0%
- palmitoleic acid (16:1) < 0.6%
- margaric acid (17:0) < 0.2%
- stearic acid (18:0) 0.9–2.0%
- oleic acid (18:1) 62.0–86.0%
- linoleic acid (18:2) (7.0–30.0%)
- linolenic acid (18:3) < 0.2%
- arachidic acid (20:0) < 0.1%
- behenic acid (22:0) < 0.1%.

The first number in brackets, e.g. 16, refers to the number of carbon atoms in the fatty acid and the second number, e.g. 0, refers to the number of double bonds in the fatty acid. The percentage of each component is determined in relation to the sum of the areas of the chromatographic peaks of all the components listed above.

In order to determine the fatty acid composition of the triglycerides, they have to be first hydrolysed and the liberated fatty acids converted to their methyl esters, which have a good chromatographic peak shape compared to the free acids. A convenient method for achieving hydrolysis and methylation in one step is shown in Figure 11.8.

A GC trace of methanolyzed almond oil is shown in Figure 11.9. It can be seen that the methyl esters stearic, oleic and linoleic acid are incompletely resolved on a BPX-5 column. The esters of the minor C-20 and C-22 acids are also incompletely

Fig. 11.8
Methanolysis of triglycerides prior to GC analysis.

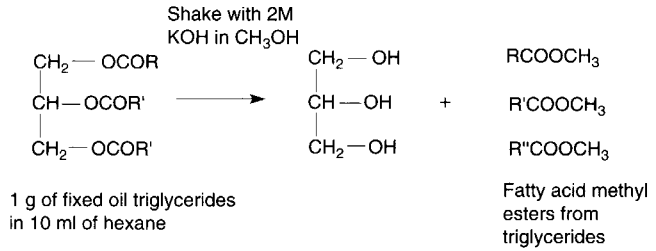
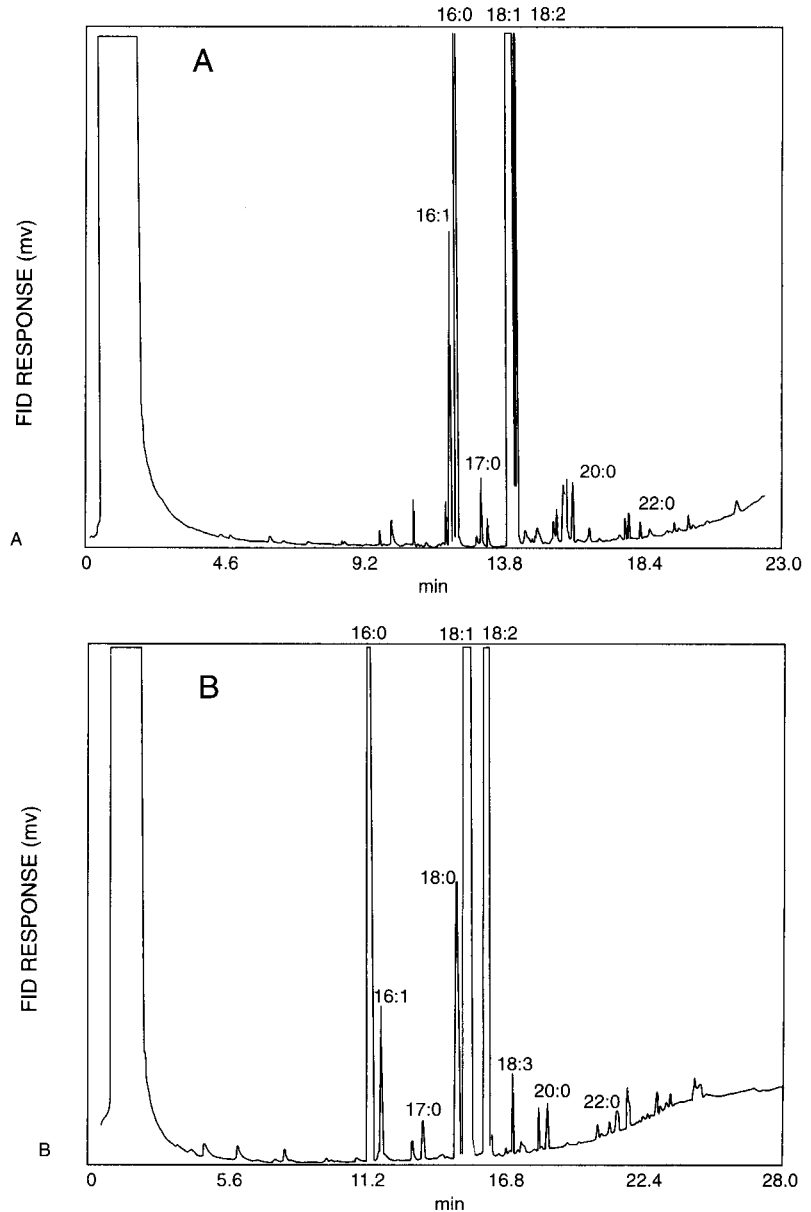

Fig. 11.9

(A) Separation of fatty acid methyl esters derived from almond oil on a BPX-5 column (12 m × 0.25 mm i.d. × 0.25 μm film). Programmed 100° (1 min) then 10°/min to 320°. The major peaks are shown as offscale so that the minor peaks can be seen clearly. (B) The same sample separated on a HP Stabilwax column (15 m × 0.25 mm × 0.5 μm film). Programmed 140° (1 min) then 5°/min to 250° (5 min).



separated. When a carbowax column is used, complete separation of oleic (18:1), linoleic (18:2), stearic acid (18:0) and a small amount of linolenic acid (18:3) in the sample is achieved.

The chromatogram obtained on the carbowax column gave the percentage of areas of the peaks in this particular sample of almond oil as follows: 16:0 (7.0%), 16:1 (0.4%), 17:0 (0.12%), 18:0 (1.5%), 18:1 (62.8%), 18:2 (28.4%), 18:3 (0.16%), 20:0 (0.09%), 22:0 (0.09%). Thus the almond oil is within the BP specification given above (Fig. 11.9B).

Chiral selectivity

An advanced type of column selectivity is chiral discrimination. Since enantiomers have identical physical properties they are not separable on conventional GC columns. However, if chiral analytes are allowed to interact with a chiral environment they will form transitory diastereomeric complexes which result in their being retained by the column to a different extent. As increasing numbers of enantiomerically pure drugs are synthesised in order to reduce side-effects, this type of separation will become increasingly important.

Chirasil Val was one of the first chiral GC phases; it has one chiral centre as can be seen in its structure as shown in Figure 11.10.

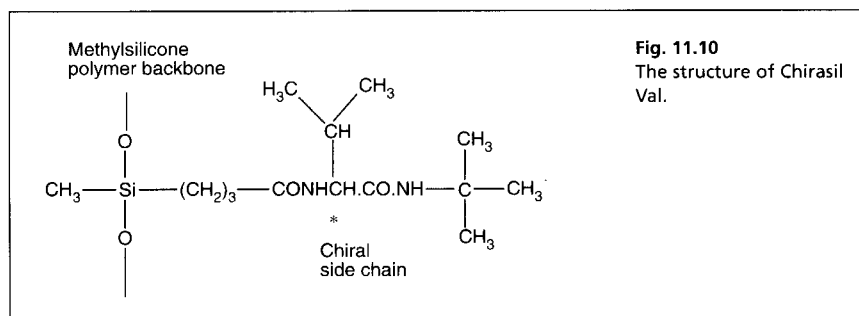

A number of variations on this type of coating have been prepared and offer some improvement over the original phase. Figure 11.11 shows the volatile pentafluoropropionamide-trifluoroethyl ester (PFP-TFE) derivatives of *L* and *D* phenylalanine. Figure 11.12 shows the separation of PFP-TFE derivatives of the *D* and *L* enantiomers of the amino acids phenylalanine and *p*-tyrosine on a Chirasil Val column, the *D(R)*-enantiomers elute first. Chirasil Val generally performs best for the separation of enantiomers of amino acids, for many other compounds it is not as effective.

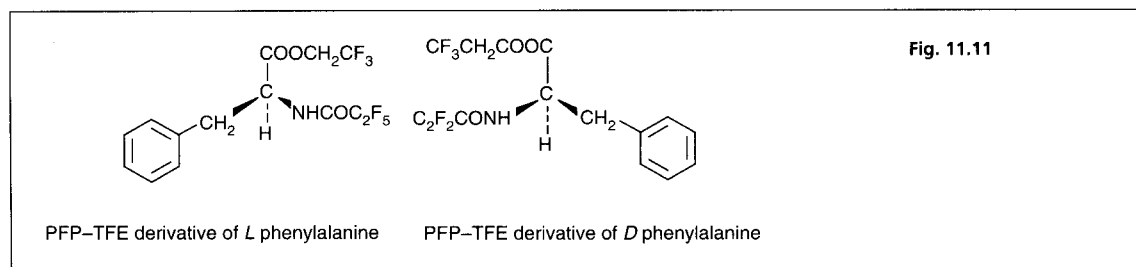
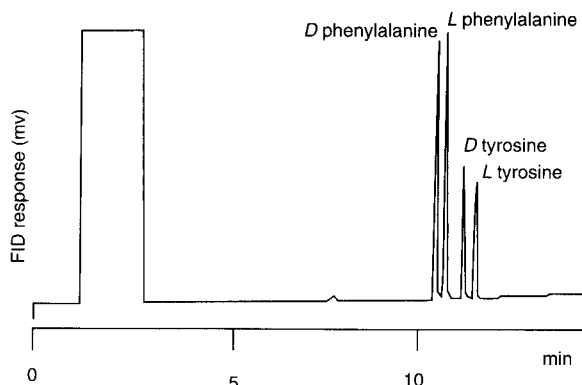

Fig. 11.12

Separation of the PFP-TFE derivatives of the D and L isomers of phenylalanine and *p*-tyrosine on a Chiralasil Val column 25 m \times 0.25 mm i.d. \times 0.16 μ m film. Programmed 120° (1 min) then 3°/min to 180°.



More recently alkylated cyclodextrins have been developed as chiral phases. These phases are based on cyclodextrins, which are cyclic structures formed from 6, 7 or 8 glucose units. Alkylation of the hydroxyl groups in the structure of the cyclodextrins lowers their melting points and makes them suitable as GC phases. The cyclodextrins contain many chiral centres and separate enantiomers of drugs according to how well they fit into the chiral cavities of the cyclodextrin units (see Ch. 12 p. 273).

An alternative to buying expensive chiral columns in order to separate enantiomers is to use a chiral derivatisation agent. These reagents can be based on natural products which usually occur in enantiomerically pure form. Chiral derivatising agents can often produce better separations than chiral columns, but if reaction conditions are too strong, there is a risk of small amounts of racemisation occurring in the analyte, i.e. chemical conversion of an enantiomer into its opposite. Reaction of an enantiomeric mixture with a chiral derivatising agent produces a pair of diastereoisomers which are separable by GC on non-chiral columns, e.g. the esters of menthol with (+) chrysanthemic acid.⁴

It can be seen in Figure 11.13 that, although the menthol portions of the esters are mirror images, addition of the chiral acylating reagent generates esters which are not mirror images but are diastereoisomers and thus have different physical properties.

Fig. 11.13

(+) chrysanthemyl esters of menthol.

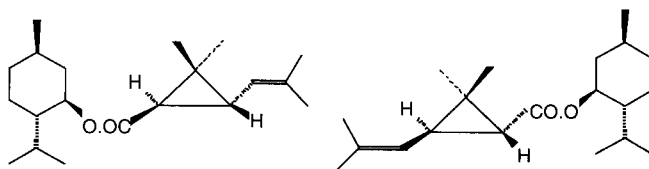

Use of derivatisation in GC

Derivatisation has been mentioned above without fully indicating why it is necessary for conducting GC analysis. Derivatisation is generally required prior to GC if a compound is highly polar so that good chromatographic peak shape can be achieved. A large number of derivatisation strategies are available.² In the following example, derivatisation is used to improve the peak shape of pseudoephedrine (Fig. 11.14).

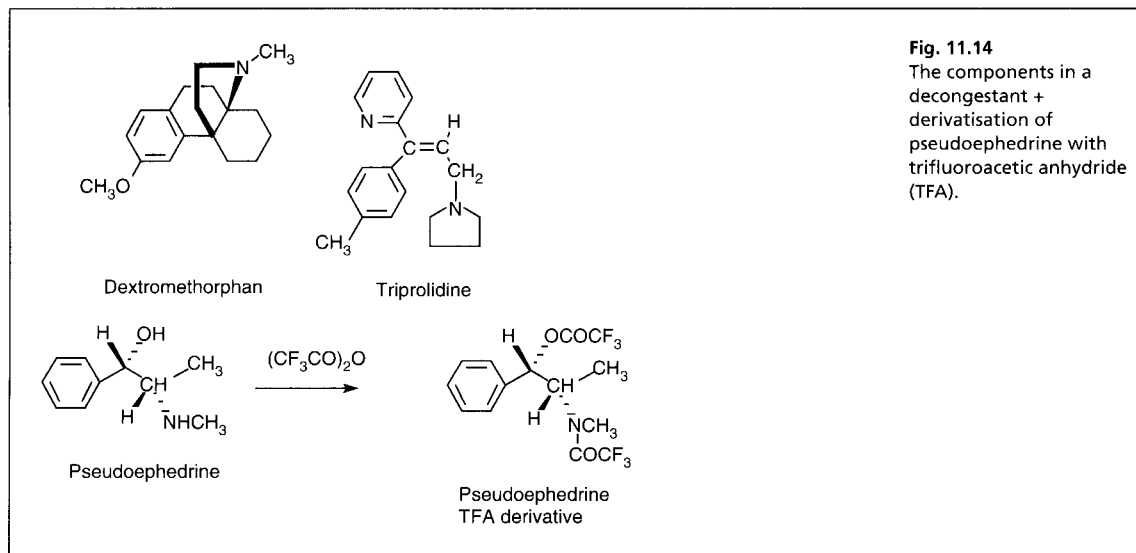

A decongestant syrup was basified with ammonia and extracted into ethyl acetate, thus ensuring that the components extracted were in their free base forms rather than their salts, which is important for obtaining good chromatographic peak shape. Salts of bases will thermally dissociate in the GC injector port but this process can cause a loss of peak shape and decomposition.

If the extract is run directly, the trace shown in Figure 11.15A is obtained. The free bases of triprolidine and dextromethorphan give good peak shape but pseudoephedrine which is stronger base and which has in addition a hydroxyl group in its structure gives a poor peak shape. This can be remedied by masking the polar alcohol and amine groups of pseudoephedrine by reaction with trifluoroacetic anhydride TFA. Treatment with TFA does not produce derivatives of the tertiary bases in the extract. This reagent is very useful because it is very reactive and boils at 40°C thus excess reagent can be evaporated very easily prior to GC analysis and thus unlike many reagents it does not leave any residue.

Silylating reagents are another popular class of derivatisation reagents. These reagents introduce residues into the sample, although this is not a great problem if the analyte is relatively involatile. An example of a silylation reaction is shown on page 226.

Summary of parameters governing capillary GC performance

Carrier gas type/flow

According to the Van Deemter equation hydrogen and helium give higher efficiencies at high flow rates compared with nitrogen. For practical analysis times hydrogen or helium are used in capillary GC and typical flow rates for hydrogen and helium are in the range of 30–50 cm/s; nitrogen has its optimum flow rate at 10–20 cm/s. Table 11.2 shows typical pressure settings to achieve optimal flow rate for three columns. The gas flow rate decreases with increasing temperature and this may have an influence on column efficiency. Modern instruments have flow programming so that the flow can be set to remain constant as the temperature rises.

Fig. 11.15

GC traces of an extract from a decongestant syrup. (A) Underderivatised and (B) after treatment with trifluoroacetic anhydride.

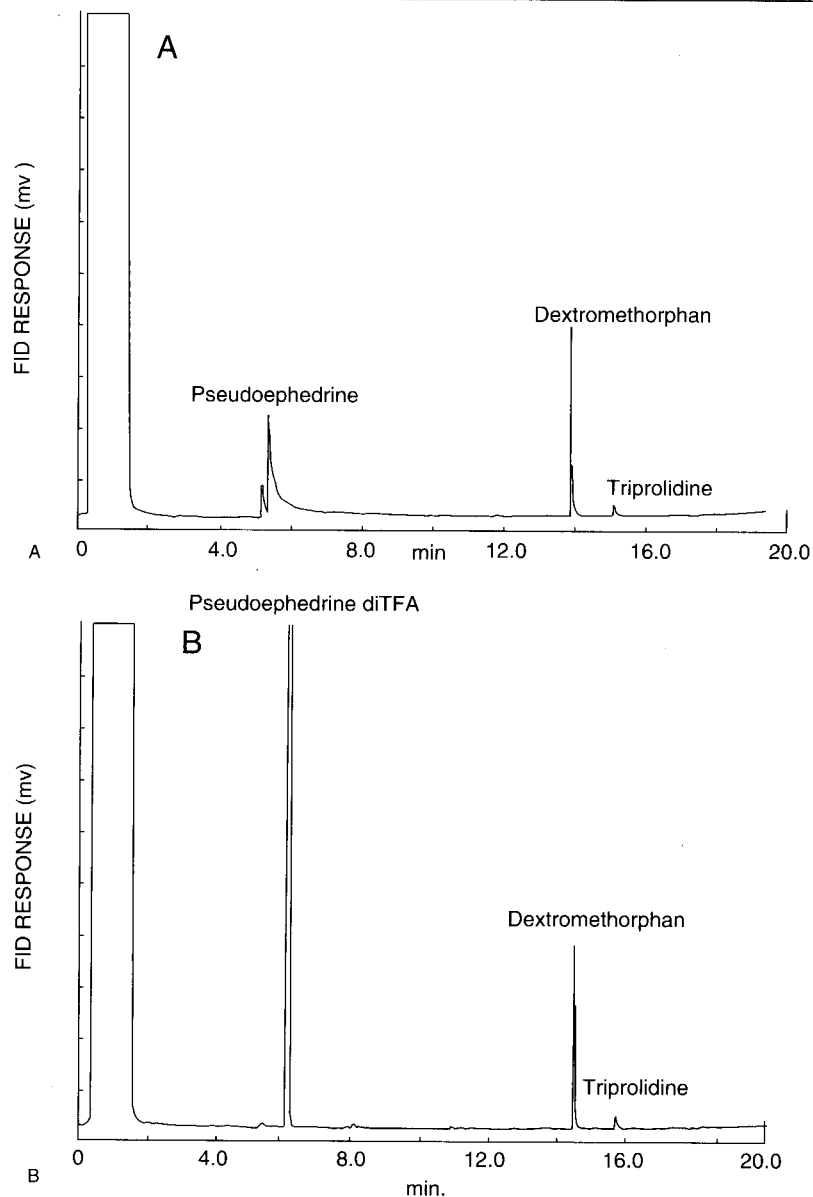
**Table 11.2** Effect of temperature on flow rate at constant pressure

Column	Pressure	Temperature (C)	T ₀ (s)	Flow rate	Temp	Flow rate (C)	T ₀ (s)
25 m × 0.5 mm i.d.	22.2 KPa	100°	83	30 cm/s	250°	23.7 cm/s	106
25 m × 0.25 mm i.d.	91.1 KPa	100°	83	30 cm/s	250°	23.7 cm/s	106
12 m × 0.25 mm i.d.	42.8 KPa	100°	40	30 cm/s	250°	23.7 cm/s	51

Column temperature

As column temperature increases the degree of resolution between two components decreases because the degree of interaction with the stationary phase is reduced as the vapour pressure of the analytes increases. Lower temperatures produce better resolution.

Column length

The separating power of a column varies as the square root of its length. Thus if a two-fold increase in resolution is required and a four-fold increase in column length would be required, this would result in a four-fold increase in analysis time. The increased resolution afforded by length can often be replaced with a decrease in temperature ensuring that more interaction with the stationary phase occurs, especially if the stationary phase has characteristics that enable it to select one analyte more than another.

Film thickness phase loading

The greater the volume of stationary phase the more a solute will partition into it. If the film thickness or loading of stationary phase doubles then in theory the retention of an analyte should double. Thus thicker films are used for very volatile materials to increase their retention time and to increase resolution between analytes without increasing the column length.

Internal diameter

The smaller the internal diameter of a capillary column the more efficient the column is for a given stationary phase film thickness on the capillary wall. This is because the mass transfer characteristics of the column are improved with the analyte being able to diffuse in and out of the mobile phase more frequently because of the shorter distance for transverse diffusion (Ch. 10 p. 201).

Self-test 11.2

A fixed temperature is used and the head pressure is adjusted so that the linear velocity of a helium carrier gas through the following capillary columns is 20 cm/s: (i) 30 m × 0.25 mm i.d. × 0.25 μm OV-1 film; (ii) 15 m × 0.15 mm × 0.2 μm OV-1 film; (iii) 12 m × 0.5 mm i.d. × 1.0 μm OV-1 film.

- List the columns in the order in which they would increasingly retain a *n*-hexadecane standard.
- List the columns in order of increasing efficiency.

Answers: a. (iii) (ii) (i) (i) (iii); b. (iii) (ii) (i)

GC detectors

There are many GC detectors available although the flame ionisation detector remains the most widely used and the most widely applicable to quality control of pharmaceutical products. However, newer detectors such as the plasma emission detector for analysis of trace impurities or the GC-FTIR detector for the structural characterisation of components in mixtures are becoming increasingly important.

Selectivity in a detector is most often required for sensitive bioanalytical methods where trace amounts of compounds are being analysed in the presence of interferants which are also present in the sample matrix. The properties of some commonly used detectors are summarised in Table 11.3.

Table 11.3 Commonly used GC detectors

Detector	Applications
<p>Flame ionisation</p> 	<p>Compounds are burnt in the flame producing ions and thus an increase in current between the jet and the collector. Detects carbon/hydrogen-containing compounds. Insensitive to carbon atoms attached to oxygen, nitrogen or chlorine. In combination with capillary GC it may detect as low as 100 pg–10 ng. Wide range of linear response ca 10^6</p>
<p>Electron capture</p> 	<p>Compounds with a high affinity for electrons enter the detector and capture the electrons produced by the radioactive source thus reducing the current to the collector. Highly halogenated compounds can be detected at the 50 fg–1 pg level. Has a large internal volume therefore some chromatographic resolution may be lost. Linearity of response is not as great as FID, e.g. 10^3. Mainly used for analysis of drugs in body fluids. Has wide application in environmental monitoring, e.g. chlorofluorocarbons in the atmosphere</p>
<p>Nitrogen phosphorus</p> 	<p>Nitrogen and phosphorus-containing compounds react with the alkali metal salt in the detector to produce species such as CN^-, various phosphorus anions or electrons all of which produce an increase in current which generates the signal. Detects phosphorus compounds at the pg level, nitrogen compounds at the low ng level. Highly selective for nitrogen and phosphorus-containing compounds. Used mainly in the analysis of drugs and their metabolites in tissues and bodily fluids</p>
<p>Thermal conductivity (TCD)</p> 	<p>Responds to cooling effect of the analyte passing over the filament. Relatively insensitive to organic compounds in comparison to FID. It is a universal detector which can be used to determine water vapour. It is also non-destructive so that analytes can be collected after detection, if required. Used to determine water in some BP assays, e.g. water in the peptides menotrophin, gonadorelin and salcatonin</p>

Table 11.3 Commonly used GC detectors (Cont.)

Detector	Applications
<p>Radiochemical detector</p> 	<p>^{14}C and ^3H present in the molecule are respectively converted to $^{14}\text{CO}_2$ and $^3\text{H}_2$. Its sensitivity depends on the degree of radioactivity of the analyte. Useful for metabolic labelling studies, making metabolites of drugs easy to detect. The detector tends to work better with packed columns since it has a large internal space</p>
<p>Microwave-induced plasma atomic emission</p> 	<p>A hot plasma of argon is produced by heating to $> 6000^\circ\text{C}$ which causes all the elements in the compound to produce emission spectra. The individual emission lines are passed through diffraction grating and detected by a diode array detector. Detects individual elements, e.g. chlorine in organochlorine pesticides and metals in organometallics. Sensitive to the pg level for some elements. Most widely used in environmental monitoring but also has useful potential for impurity profiling of drugs and metabolism studies</p>
<p>Fourier transform (FT) infrared (IR) detector</p> 	<p>Essentially just an FT-IR instrument coupled to a GC, thus allowing IR spectra of compounds eluting from the GC column to be obtained. More useful for structure elucidation rather than quantitative studies. The detector is sensitive to the 10 ng level. Used as a tool for qualitative identification. There are some examples of quantitative applications, e.g. determination of propandiol in acyclovir cream.⁵</p>

Applications of GC in quantitative analysis

HPLC has more or less supplanted GC as a method for quantifying drugs in pharmaceutical preparations. Many of the literature references to quantitative GC assays are thus old and the precision which is reported in these papers is difficult to evaluate based on the measurement of peak heights or manual integration. It is more difficult to achieve good precision in GC analysis than in HPLC analysis and the main sources of imprecision are the mode of sample introduction, which is best controlled by an autosampler, and the small volume of sample injected. However, it is possible to achieve levels of precision similar to those achieved using HPLC methods. For certain compounds that lack chromophores, which are required for detection in commonly used HPLC methods, quantitative GC may be the method of choice, for analysis of many amino acids, fatty acids, and sugars. There are a number

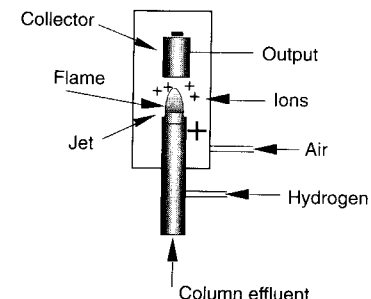
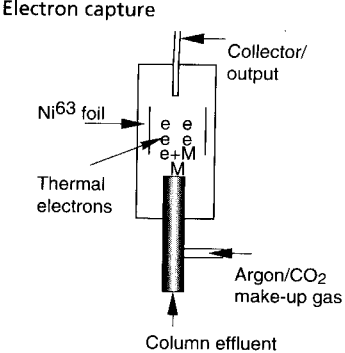
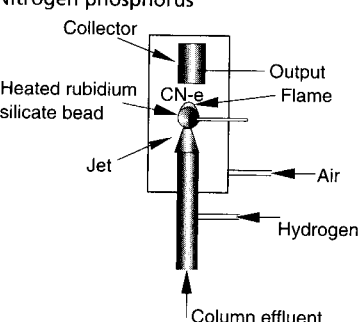
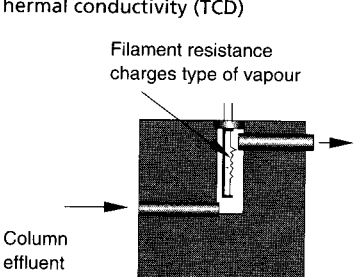
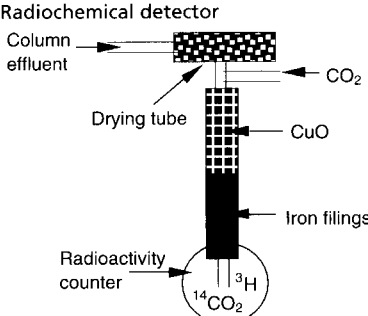
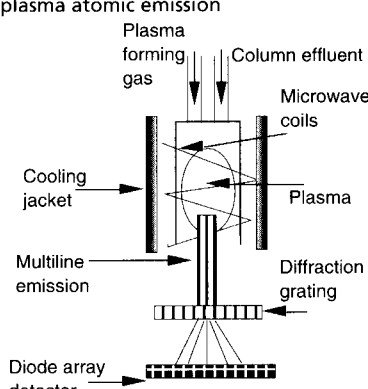
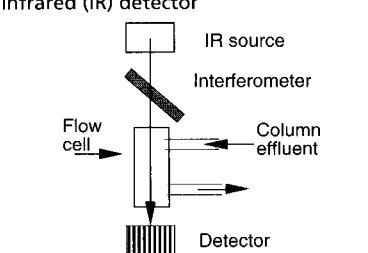
of assays in the BP, US Pharmacopoeia and the European Pharmacopoeia which are based on GC, but the selection of compounds analysed in this way appears to be rather random and many of the assays described could also be carried out by HPLC. The BP format for assays (both for HPLC and GC assays) is, most often, to run three samples. These are: a calibration standard containing more or less equal amounts of a pure standard and an internal standard (Solution 1); an extract of the sample containing no internal standard to check for interference from the formulation matrix (Solution 2); and an extract from the sample containing the same amount of internal standard as Solution 1 (Solution 3). This is illustrated in Figure 11.16 for the analysis of methyltestosterone in a tablet formulation using testosterone as an internal standard p. 259.

Fig. 11.16

Chromatograms of Solutions 1, 2 and 3 prepared for the analysis of methyltestosterone tablets. RTX-1 column 15 m × 0.25 mm i.d. × 0.25 μm film. Programmed 150°(1 min) then 10°/min to 320°C (5 min).

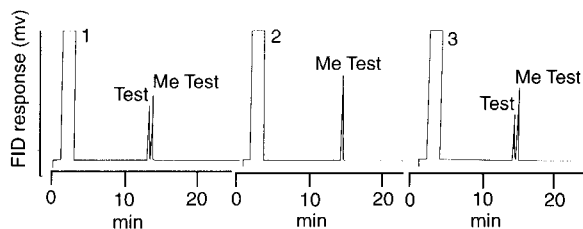

Analysis of methyltestosterone in tablets

A calibration solution containing *ca* 0.04% w/v of methyltestosterone and *ca* 0.04% w/v testosterone in ethanol is prepared (Solution 1). A weight of tablet powder containing *ca* 20 mg of methyltestosterone is extracted with 50 ml of ethanol to prepare Solution 2. Solution 3 is prepared by dissolving tablet powder containing *ca* 20 mg of methyltestosterone in *exactly* 50 ml of ethanol containing *exactly* the same concentration of testosterone as Solution 1. In this example 0.5 μl amounts of the solutions were injected into the GC in the splitless mode.

Solution 1 gives a response factor for the calibration solution as follows:

$$\frac{\text{area of methyltestosterone peak in calibration solution}}{\text{area of testosterone peak in calibration solution}}$$

Solution 3 gives a response factor for the sample as follows:

$$\frac{\text{area of methyltestosterone peak in sample solution}}{\text{area of testosterone peak in sample solution}}$$

The amount of methyltestosterone in the tablet powder can be calculated as follows:

$$\text{amount of methyltestosterone} = \frac{\text{response factor for sample}}{\text{response factor for calibration solution}} \times \%w/v \text{ of methyltestosterone in calibration solution} \times \frac{\text{vol. sample solution}}{100}$$

Data from analysis of methyltestosterone tablets

- Weight of 5 tablets = 0.7496 g
- Stated content of methyltestosterone per tablet = 25 mg

- Weight of tablet powder taken for assay = 0.1713 g
- Solution 1 contains: 0.04% w/v methyltestosterone and 0.043% w/v testosterone
- Solution 3 contains: the methyltestosterone extracted from the powder taken for assay and 0.043% w/v testosterone
- Solution 1: Peak area testosterone = 216 268; Peak area methyltestosterone = 212 992
- Solution 3: Peak area testosterone = 191 146; Peak area methyltestosterone = 269 243.

Calculation example 11.1

$$\text{Response factor for Solution 1} = \frac{212\,992}{216\,268} = 0.9849$$

$$\text{Response factor for Solution 3} = \frac{269\,243}{191\,146} = 1.409$$

Amount of methyltestosterone in the tablet powder determined by analysis =

$$\frac{1.409}{0.9849} \times 0.04 \times \frac{50}{100} = 0.02861 \text{ g} = 28.61 \text{ mg}$$

Amount of methyltestosterone expected in tablet powder =

$$\frac{\text{weight of powder analysed}}{\text{weight of 5 tablets}} \times \text{stated content of 5 tablets} = \frac{0.1713}{0.7496} \times 5 \times 25 = 28.57 \text{ mg}$$

$$\text{Percentage of stated content} = \frac{28.61}{28.57} \times 100 = 100.1\%$$

A dilution factor may be incorporated into this calculation if the sample is first extracted and then diluted in order to bring it into the working range of the instrument. This approach to quantitation does not address the linearity of the method but since the variation in the composition of formulations should be within $\pm 10\%$ of the stated amount there is some justification for using it. The precision of the method is readily addressed by carrying out repeat preparations of sample and calibration solutions.

Analysis of atropine in eyedrops

Another group which is used to mask polar groups in molecules in order to improve GC peak shape is the trimethylsilyl group. Atropine Eye Drops BP are used to dilate the pupil prior to cataract surgery. The 1993 BP method for the analysis of Atropine Eye Drops BP uses derivatisation with a trimethylsilyl group to mask an alcohol group as shown in Figure 11.17.

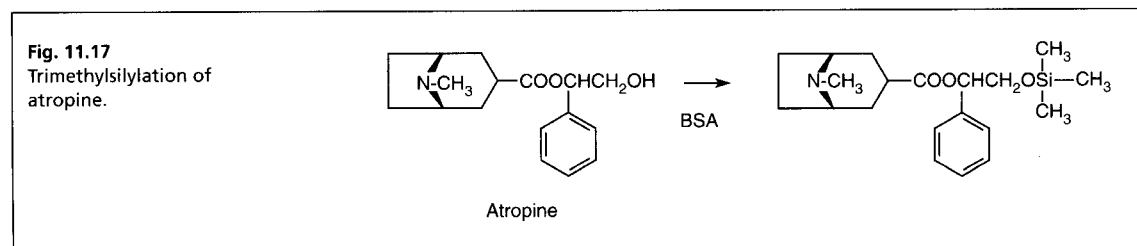

The method involves extraction of atropine and a homatropine internal standard from the aqueous phase which is rendered alkaline by the addition of ammonia followed by trimethylsilylation with *N*,*O*-bistrimethylsilyl acetamide (BSA).

In the calculation using the results of this experiment it is better to use amount rather than concentration as a standard measure since after the initial accurate volume measurement used for the addition of the standard and internal standard to the calibration solution (Solution 1) and for the addition of the internal standard to a fixed volume of eyedrops the volumes need only be measured approximately; this is the advantage of using an internal standard (Fig. 11.18). The following formula is used:

$$\text{amount of atropine in the eyedrop sample} = \frac{\text{response factor for sample}}{\text{response factor for calibration solution}} \times \text{amount of atropine in calibration solution}$$

Fig. 11.18
Chromatograms of solutions 1, 2 and 3 prepared for the analysis of atropine in eyedrops. RTX-1 column 15 m × 0.25 mm i.d. × 0.25 μm film. Programmed 140°C (1 min) then 10°/min to 320°C (5 min).

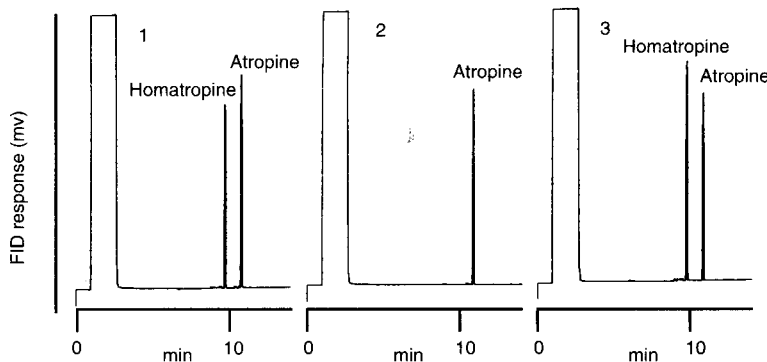

Brief description of the assay

Solution 1 is prepared from *exactly* 5 ml of 0.4092% w/v atropine sulphate solution and *exactly* 1 ml of 2.134% w/v homatropine hydrobromide solution. The solution is basified and extracted, the solvent is removed and the residue is treated with 2 ml of BSA and then diluted to 50 ml with ethyl acetate. Solution 3 is prepared from *exactly* 2 ml of eyedrops and *exactly* 1 ml of 2.134% w/v homatropine hydrobromide solution. The solution is basified and extracted, the solvent is removed and the residue is treated with 2 ml of BSA and then diluted to 50 ml with ethyl acetate.

Data from analysis of eyedrop formulation

- Volume of eyedrops analysed = 2.0 ml
- Stated content of eyedrops = 1.0% w/v
- Solution 1: Peak area homatropine TMS = 118 510; Peak area atropine TMS = 146 363
- Solution 3: Peak area homatropine TMS = 145 271; Peak area atropine TMS = 117 964.

Calculation example 11.2

Amount of atropine sulphate in Solution 1 = $0.4092 \times \frac{5}{100} = 0.02046$ g.

Response factor for Solution 1 = $\frac{146\ 363}{118\ 510} = 1.2350$.

Response factor for Solution 3 = $\frac{117\ 964}{145\ 271} = 0.8120$.

Amount of atropine sulphate in Solution 3 = $\frac{0.8120}{1.2350} \times 0.02046$ g = 0.01345 g.

This was the amount originally present in 2 ml of eyedrops therefore percentage of w/v of atropine sulphate in eyedrops

$$= 0.01345 \times \frac{100}{2} = 0.6725\% \text{ w/v.}$$

The amount determined in the eyedrops is well below the stated amount of 1% w/v and this is because this sample of eyedrops was *ca* 10 years old and had probably suffered extensive degradation.

Self-test 11.3

Calculate the percentage of the stated content of hyoscine hydrobromide in travel sickness tablets from the following data. The assay is carried out in a manner similar to the eyedrop assay described above. The amount of atropine added as an internal standard does not enter into the calculation if we assume that the same amount is added to Solutions 1 and 3.

- Weight of 20 tablets = 2.1881 g
- Weight of tablet powder taken = 0.9563 g
- Stated content per tablet = 0.6 mg
- Concentration of hyoscine hydrobromide standard solution = 0.0341% w/v
- Volume of hyoscine hydrobromide solution added to Solution 1 = 15 ml
- Area of hyoscine peak in Solution 1 = 147 881
- Area of atropine peak in Solution 1 = 159 983
- Area of hyoscine peak in Solution 3 = 167 799
- Area of atropine peak in Solution 3 = 173 378.

Answer: 102.1%

Quantification of ethanol in a formulation

Gas chromatography provides a useful method for quantifying very volatile materials. In this case columns are required, which strongly retain volatile compounds. Ethanol is used in the preparation of tinctures and in disinfectant solutions. Typically ethanol may be quantified against a related alcohol. In the 1993 BP assay of chloroxylenol solution ethanol is quantified against a propan-1-ol internal standard. The column used is packed with Porapak Q; Porapak is an example of a porous polymeric stationary phase which retains low molecular weight compounds strongly. These types of phases are also effective in separating gases such as CO₂, ammonia and acetylene. As an alternative to a Porapak column, a thick film (e.g. 5 μm film) GC capillary column may be used for this type of analysis.

Determination of manufacturing and degradation residues by GC

Determination of pivalic acid in dipivefrin eye drops

GC provides a useful technique for estimating volatile degradation products. For example the pivalic acid release from the hydrolysis of dipivefrin in an eyedrop preparation (Fig. 11.19) used for treating glaucoma may be estimated by GC.⁶ Isovaleric acid, which is an isomer of pivalic acid, provides a suitable internal standard. Breakdown products of esters are more likely to occur in aqueous formulations such as eyedrops or injections.

Fig. 11.19
Breakdown of dipivefrin resulting in formation of pivalic acid.

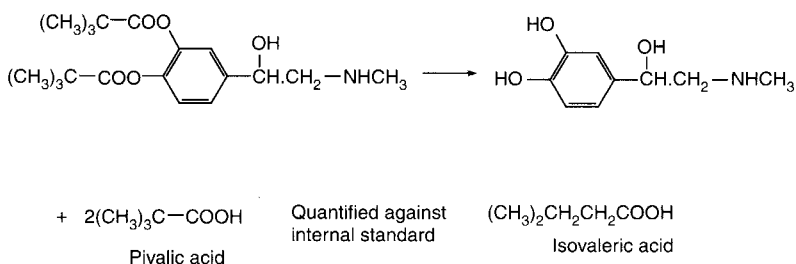

Dimethylaniline in bupivacaine injection (Fig. 11.20)

Dimethylaniline is both a manufacturing impurity in bupivacaine and since it is formulated in injections a possible breakdown product, although hydrolysis of amides is much slower than hydrolysis of esters. The BP uses a spectrophotometric method to assay for this impurity but GC provides a more sensitive and specific method for this determination.

Fig. 11.20
Bupivacaine and its degradation product.

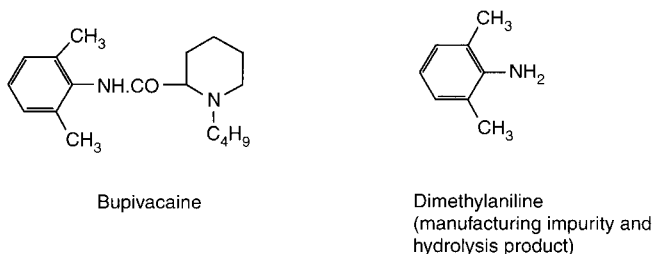

The GC trace obtained from injection of a 10% w/v solution of bupivacaine free base extracted from an injection gave the trace shown in Figure 11.21. It is apparent from comparison with a standard for dimethylaniline that there is $\leq 0.1\%$ of the impurity present although a number of other peaks due to excipients or impurities can be seen in the GC trace.

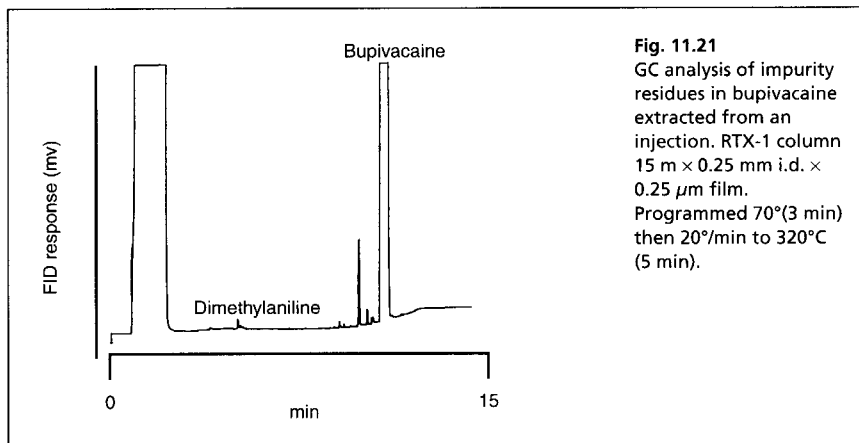

Determination of a residual glutaraldehyde in a polymeric film

Sometimes derivatisation can provide a highly specific method of detecting impurities. In this example the low molecular weight impurity glutaraldehyde, which is not stable to direct analysis by GC, is reacted with a high molecular weight derivatising reagent pentafluorobenzoyloxime; the reaction is shown in Figure 11.22. This reaction stabilises the analyte and increases its retention time into a region where it can be readily observed without interference from other components extracted from the sample matrix. The derivative is also highly electron capturing. In this example a GC method was found to be superior to a HPLC method using derivatisation with dinitrophenylhydrazine since the residues from the reagent produced less interference in the analysis.

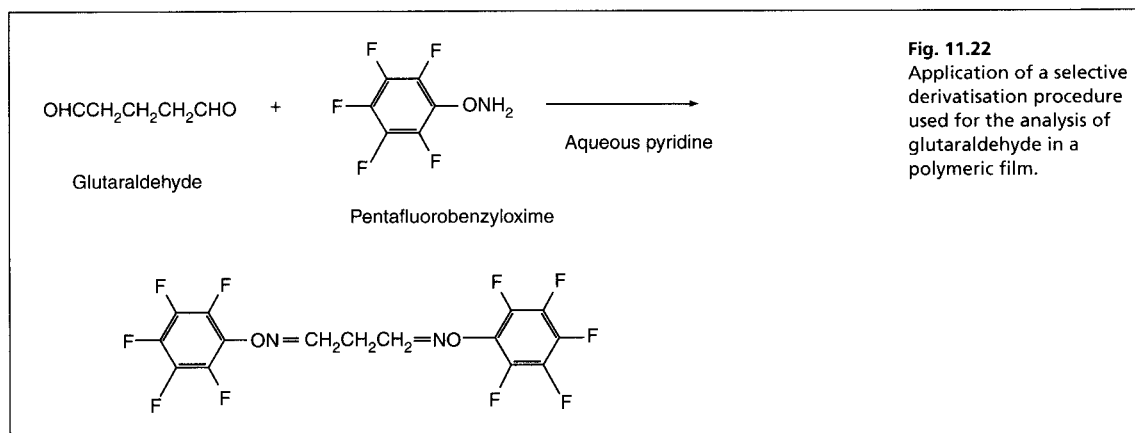

The converse of this type of reaction has been used to determine hydrazine as a manufacturing impurity in the drug hydralazine by reaction of the hydrazine residue with benzaldehyde to form a volatile derivative for GC analysis.⁷

Determination of residual solvents

Typical BP procedures

The current BP methods for determination of solvent residues in pharmaceuticals remaining from the manufacturing process rely on direct injection of the sample dissolved in a suitable solvent (often water) and are based on packed column GC. Some examples are given in Table 11.4.

Table 11.4 Some BP procedures for the analysis of residual solvents

Drug	Residues	GC conditions
Ampicillin sodium	Dichloromethane	10% polyethylene glycol 60°
Ampicillin sodium	Dimethyl aniline	3% OV-17 80°
Colchicine	Ethyl acetate and chloroform	10% polyethylene glycol 75°
Gentamycin sulphate	Methanol	Porapak Q 120°
Menotrophin	water	Chromosorb 102, 114°, TCD
Warfarin sodium	Propan-2-ol	10% polyethylene glycol 70°

Determination of residual solvents and volatile impurities by head space analysis

A more refined method for determining residual solvents and volatile impurities is based on head space analysis.

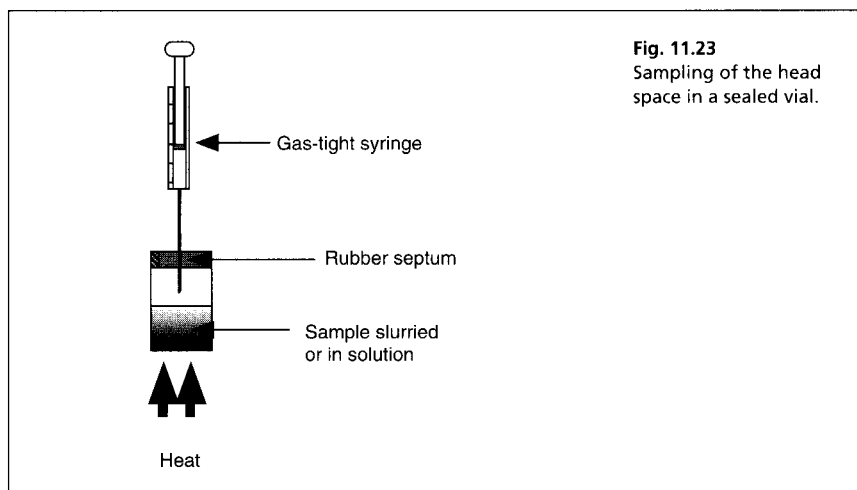

Fig. 11.23
Sampling of the head space in a sealed vial.

The simplest method of sampling is to put the sample into a sealed vial and heat it as shown in Figure 11.23. The sample, either in solution or slurried with a relatively involatile solvent with little potential for interference, e.g. water, is put into a sealed vial fitted with a rubber septum and heated and agitated until equilibrium is achieved. Then a fixed volume of head space, e.g. 1 ml is withdrawn. The sample is then injected into a GC in the usual way. If capillary column GC is used a split injection has to be used to facilitate sample injection; a flow of 10:1 out of the split vent would ensure that a 1 ml sample could be injected in about 5 s with the flow through the column being 1 ml/min. Several points are important to note:

- (i) Partition equilibrium must be established by heating for an appropriate length of time and at an appropriate temperature
- (ii) A clean room is required away from all other sources of volatiles such as laboratory solvents
- (iii) Potential interference from rubber septa must be checked
- (iv) Reactive contaminants may react with the sample matrix at high temperatures
- (v) If the sample is ground and mixed in preparation for the head space analysis care has to be taken to ensure that no volatiles are lost.

For best reproducibility the process should be automated and for quantitative accuracy it would be best to use the method of standard additions (Ch. 6 p. 123). Suitable columns include packed columns containing Porapak Q or long thick film (3–5 μm) capillary columns, which for best selectivity should be coated with a phase which is moderately polar to polar.

Figure 11.24 shows a chromatographic trace for residual solvents in a sample of cephalosporin obtained by automatic sampling of the head space in a sealed vial.⁸ The cephalosporin sample (300 mg) was suspended in diethylene glycol (DEG) (the low vapour pressure of this material meant that it was not present in large amounts in the head space).

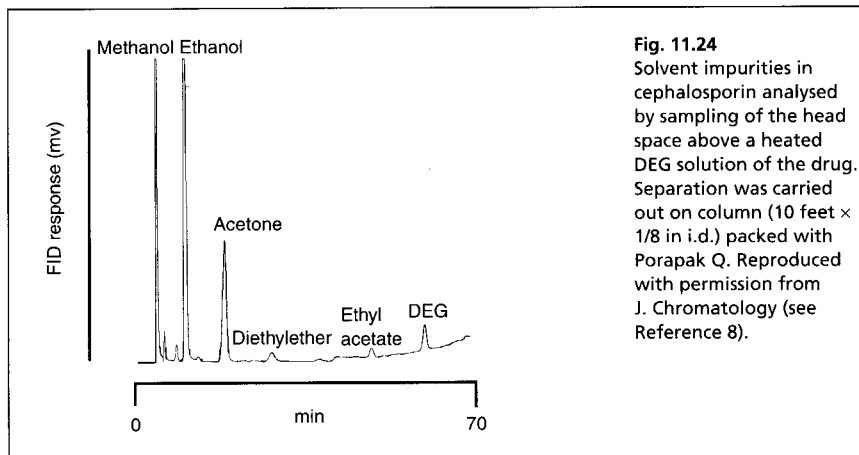

Self-test 11.4

Which of the following capillary columns would be most suitable for use in the determination of residual solvents by head space analysis (consult Table 11.1):

- (i) OV-1 column 12 m \times 0.2 mm i.d. \times 0.25 μm film
- (ii) OV-17 column 15 m \times 0.33 mm i.d. \times 0.5 μm film
- (iii) OV-225 column 30 m \times 0.5 mm i.d. \times 3 μm film
- (iv) OV-1 column 25 m \times 0.5 mm i.d. \times 1 μm film.

Answer: (iii)

Purge trap analysis

Another form of head space analysis uses a purge trapping device to trap volatile impurities. In this technique a gas, e.g. helium, is bubbled through the sample which is dissolved in suitable solvent (usually water) and the volatile impurities are thus 'stripped' from the solution and passed in the stream of gas through a polymeric adsorbant where they become trapped and thus concentrated. The stream of gas is then switched so it passes in reverse direction through the polymeric trap, which is heated to desorb the trapped volatiles and the gas stream is then diverted into the GC. This type of procedure is used in environmental analysis to concentrate volatiles in water which are present at low levels.

Self-test 11.5

Suggest an analytical procedure based on GC for solving the following problems:

- (i) Determination of residual solvents in a penicillin.
- (ii) Determination of the stability, in a formulation, of a drug with a propyl ester group.
- (iii) Determination of an amphetamine sulphate in tablet form.
- (iv) Determination of terbutaline in tablet form.

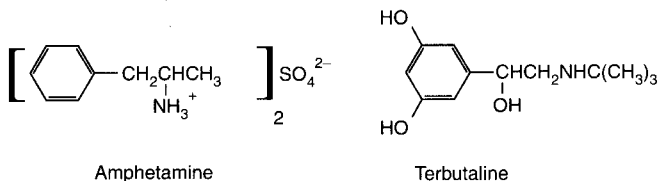

Answers: (i) see p. 232; (ii) see p. 226; (iii) see p. 239; (iv) see p. 226

Applications of GC in bioanalysis

In order to determine an optimum dosage regimen for a drug and to determine its mode of metabolism, methods for analysis of the drug and its metabolites in blood, urine and tissues have to be developed. Analysis of drugs in biological fluids and tissues by GC is quite common although GC-MS (see Ch. 9) has replaced many GC methods which are reliant on less selective types of detector.

A typical application of GC to the determination of a drug in plasma is in the determination of the anti-epileptic drug valproic acid⁹ after solid phase extraction (see Ch. 15) by GC with flame ionisation detection. In this procedure, caprylic acid, which is isomeric with valproic acid, was used as an internal standard. The limit of detection for the drug was 1 µg/ml of plasma. The trace shown in Figure 11.25 indicates the more extensive interference from background peaks extracted from the biological matrix which occurs in bioanalysis compared to the quality control of bulk materials.

An example of the use of GC with nitrogen selective detection is in the quantification of bupivacaine in plasma.¹⁰ Bupivacaine contains two nitrogen atoms in its structure which makes it a good candidate for this type of analysis. The limits of detection which can be achieved with a nitrogen selective detector for this compound are much better than methods based on flame ionisation detection, which are much less selective.

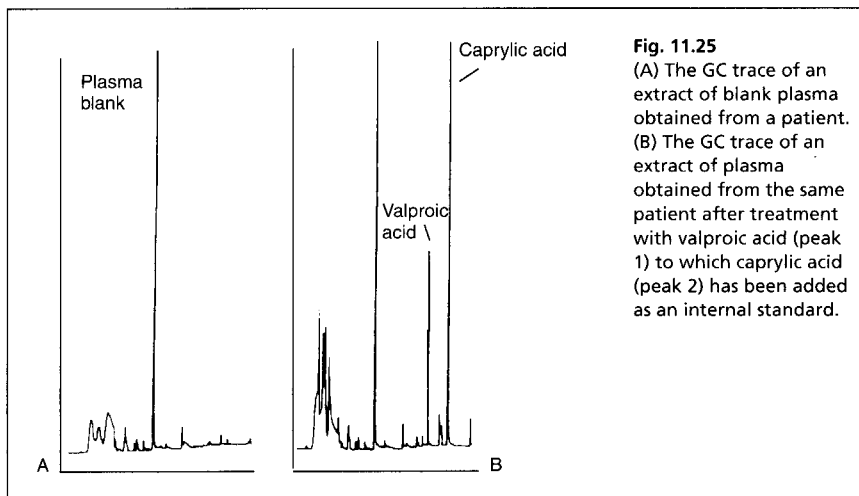

Additional problems

1. Indicate the order of elution of the following compounds from an OV-1 column.

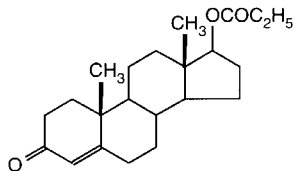

1 Testosterone propionate

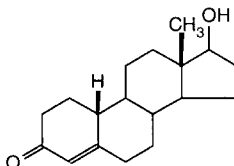

2 Nandrolone

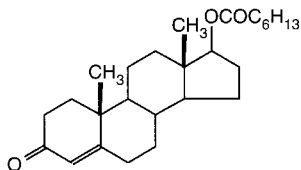

3 Testosterone heptanoate

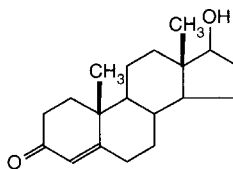

4 Testosterone

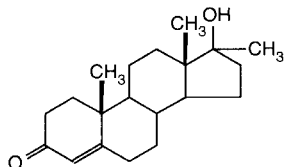

5 Methyltestosterone

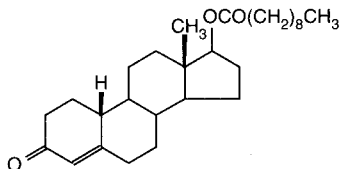

6 Nandrolone decanoate

Answers: 2,4,5,1,3,6

References

1. D.G. Watson. Chemical derivatisation in gas chromatography. In: P. Baugh, ed. *Gas Chromatography A Practical Approach*. IRL Press, Oxford (1995) 133–170.
2. K. Grob. *Anal. Chem.* 66, 1009A–1019A (1994).
3. A.C. Moffat. *Clarke's isolation and identification of drugs*. Pharmaceutical Press (1986).
4. C.J.W. Brooks, M.T. Gilbert and J.D. Gilbert. *Anal. Chem.* 45, 896 (1973).
5. A.S. Gilbert, C.J. Moss, P.L. Francis, M.J. Ashton and D.S. Ashton. *Chromatographia*. 42, 305–308 (1996).
6. L. Hall. *J. Chromatogr.* 679, 397–401 (1994).
7. O. Gyllenhaal, L. Grönberg and J. Vessman. *J. Chromatogr.* 511, 303–315 (1990).
8. J.P. Guimbard, M. Person and J.P. Vergnaud. *J. Chromatogr.* 403, 109–121 (1987).
9. M. Krogh, K. Johansen, F. Tønneson and K.E. Rasmussen. *J. Chromatogr.* 673, 299–305 (1995).
10. L.J. Leskot and J. Ericson. *J. Chromatogr.* 182, 226–231 (1980).

Additional reading

Basic Gas Chromatography. H.M. McNair and J.M. Miller. Wiley Interscience, Chichester (1997).
Capillary Gas Chromatography. D.W. Grant. Wiley Interscience, Chichester (1996).
Headspace Analysis and Related Methods in Gas Chromatography. B.V. Ioffe, A.G. Vitenberg and I.A. Manatov. Wiley Interscience, Chichester (1984).

12

High-pressure liquid chromatography

Keypoints

Introduction

Instrumentation

Stationary and mobile phases

Structural factors which govern rate of elution of drugs from HPLC columns

Elution of neutral compounds

Control of elution rate of ionisable compounds by adjustment of the pH of the mobile phase

Summary of stationary phases used in HPLC

Summary of detectors used in HPLC

Performance of a diode array detector (DAD)

Applications of HPLC to the quantitative analysis of drugs in formulations

Analyses based on calibration with an external standard

Analysis of paracetamol tablets using a calibration curve

Assay of paracetamol and aspirin in tablets using a narrow range calibration curve

Assay of active ingredients in a linctus using a single point calibration for each analyte

Assays using calibration against an internal standard

Assay of hydrocortisone cream with one-point calibration against an internal standard

Assay of miconazole cream with calibration against an internal standard over a narrow concentration range

Assays involving more specialised HPLC techniques

Assay of adrenaline by chromatography with an anionic ion-pairing reagent

Assay of ascorbic acid by chromatography with a cationic ion-pairing reagent and electrochemical detection

Assay of proteins using wide-pore HPLC packings

Assay of hyaluronic acid by size exclusion chromatography

Analysis of non-ionic surfactants with an ELSD and gradient elution

Assay of catecholamines in urine by ion exchange chromatography with electrochemical detection

Derivatisation in HPLC analysis

Separation of enantiomers by chiral HPLC

Additional problems

KEYPOINTS

Principles

A liquid mobile phase is pumped under pressure through a stainless steel column containing particles of stationary phase with a diameter of 3–10 μm . The analyte is loaded onto the head of the column via a loop valve and separation of a mixture occurs according to the relative lengths of time spent by its components in the stationary phase. It should be noted that all components in a mixture spend more or less the same time in the mobile phase in order to exit the column. Monitoring of the column effluent can be carried out with a variety of detectors.

Applications

- The combination of high-pressure liquid chromatography (HPLC) with monitoring by UV/visible detection provides an accurate, precise and robust method for quantitative analysis of pharmaceutical products and is the industry standard method for this purpose.
- Monitoring of the stability of pure drug substances and in drugs in formulations with quantitation of any degradation products.
- Measurement of drugs and their metabolites in biological fluids.
- Determination of partition coefficients and pK_a values of drugs and of drug protein binding.

Strengths

- Easily controlled and precise sample introduction ensures quantitative precision.
- HPLC is the chromatographic technique which has seen the most intensive development in recent years leading to improved, columns, detectors and software control.
- The variety of columns and detectors means that the selectivity of the method can be readily adjusted.
- Compared to GC there is less risk of sample degradation because heating is not required in the chromatographic process.
- Readily automated.

Limitations

- There is still a requirement for reliable and inexpensive detectors which can monitor compounds that lack a chromophore.
- Drugs have to be extracted from their formulations prior to analysis.
- Large amounts of organic solvent waste is generated, which is expensive to dispose of.

Introduction

HPLC is the technique most commonly used for the quantitation of drugs in formulations (Fig. 12.1). Pharmacopoeial assays still rely quite heavily on direct UV spectroscopy but in industry detection by UV spectrophotometry is usually combined with a preliminary separation by HPLC. The theoretical background of HPLC has been dealt with in Chapter 10. There are many comprehensive books on this technique.¹⁻⁵

Instrumentation

A standard instrumental system for isocratic elution consists of:

- (i) A solvent reservoir.
- (ii) A pump capable of pumping solvent up to a pressure of 4000 psi and at flows of up to 10 ml/min.
- (iii) A loop injector which may be fitted with a fixed volume loop between 1 and 200 μl (20 μl is often used as standard).

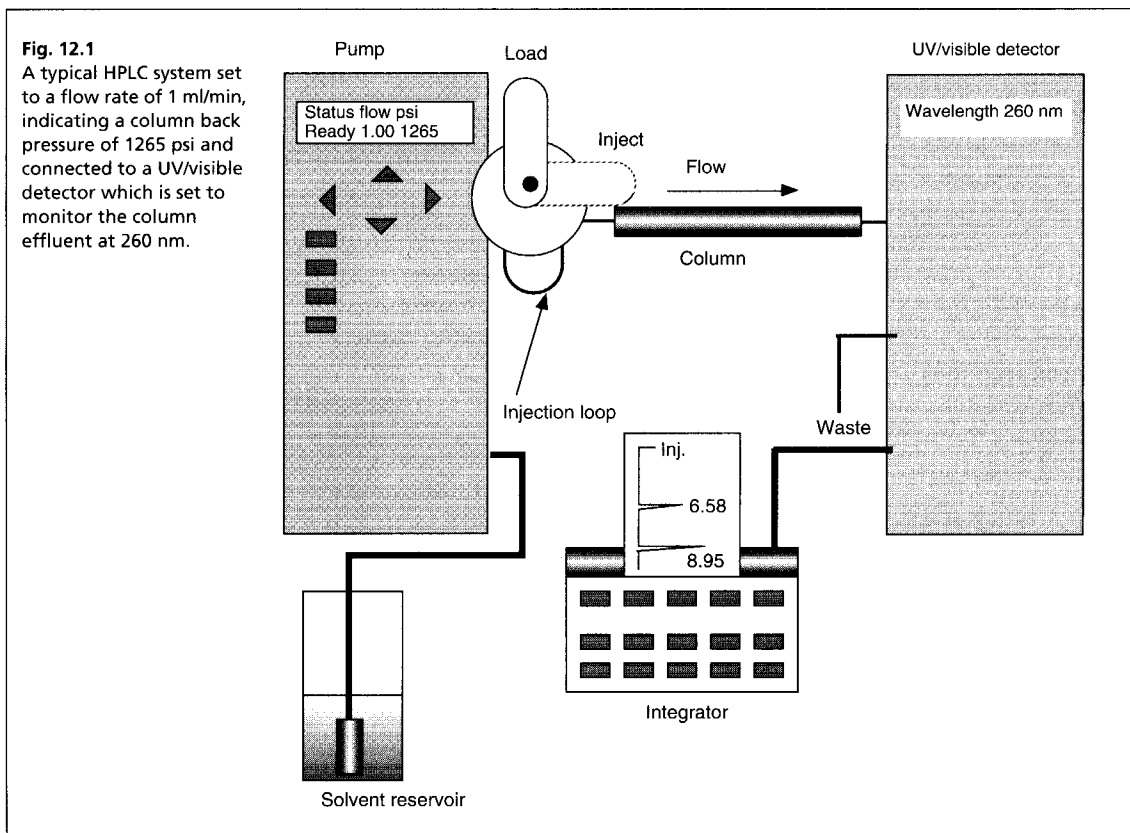

- (iv) A column, which is usually a stainless steel tube packed, usually, with octadecylsilane coated (ODS-coated) silica gel of average particle diameter (3, 5 or 10 μm).
- (v) A detector, which is usually a UV/visible detector, although for specialist applications a wide range of detectors is available.
- (vi) A data capture system, which may be a computing integrator or a PC with software suitable for processing chromatographic data.
- (vii) The column is connected to the injector and detector with tubing of narrow internal diameter *ca* 0.2 mm in order to minimise 'dead volume', i.e. empty space in the system where chromatography is not occurring and band broadening can occur by longitudinal diffusion.
- (viii) More advanced instruments may have automatic sample injection and a column oven and are capable of mixing two or more solvents in varying proportions with time to produce a mobile phase gradient.

Stationary and mobile phases

There are two principal mechanisms which produce retardation of a compound passing through a column. These are illustrated in Figure 12.2 for silica gel, which is a straight-phase packing, where the mechanism of retardation is by adsorption of the polar groups of a molecule onto the polar groups of the stationary phase. Also included in this figure is ODS-coated silica gel, which is a reverse-phase packing,

Self-test 12.1

Prednisolone (see Fig. 12.3 for the structure) is to be eluted from an ODS column.

List the following solvent systems in order of decreasing rate at which they will elute prednisolone (i.e. in order of decreasing strength):

1. a. (i) methanol/water (20:80); (ii) methanol/water (80:20); (iii) methanol/water (50:50).
b. (i) acetonitrile/water (50:50); (ii) methanol/water (50:50); (iii) acetonitrile/water/THF (50:40:10).

Prednisolone is to be eluted from a silica gel column.

List the following systems in order of decreasing rate at which they will elute prednisolone:

2. (i) hexane/isopropanol (90:10); (ii) hexane/dichloromethane (90:10); (iii) dichloromethane/methanol (90:10); (iv) dichloromethane/isopropanol (90:10); (v) dichloromethane/methanol (80:20).

Answers: 1. a. (ii), (iii), (i); b. (iii), (ii), (i); 2. (i), (ii), (iii), (v), (iv), (iii), (ii), (i).

Structural factors which govern rate of elution of compounds from HPLC columns

Elution of neutral compounds

For a neutral compound it is the balance between its polarity and lipophilicity which will determine the time it takes for it to elute from an HPLC column; the pH of the mobile phase does not play a part. In the case of a reverse-phase column, the more lipophilic a compound is the more it will be retained. For a polar column such as a silica gel column the more polar a compound is the more it will be retained. Polarity can often be related to the number and hydrogen bonding strength of the hydroxyl groups present in the molecule; this is illustrated as follows for a series of corticosteroids shown in Figure 12.3. When these compounds are eluted from a reverse-phase column using a mobile phase containing methanol/water (75:25), the expected order of elution would be: prednisolone, betamethasone, betamethasone 17-valerate, betamethasone 21-valerate and betamethasone dipropionate.

Prednisolone should elute shortly before betamethasone since it lacks a lipophilic methyl group at position 16 (the fluorine group in betamethasone also contributes to its lipophilicity); the valerates both have large lipophilic ester groups masking one of their hydroxyl groups. The 21-hydroxyl group hydrogen bonds more strongly to the mobile phase since it is an unhindered primary alcohol; thus its conversion to an ester has a greater effect on the retention time of the molecule than esterification of the 17-hydroxyl group, which is a tertiary alcohol and is hindered with respect to hydrogen bonding to the mobile phase. Finally, the dipropionate of betamethasone has two lipophilic ester groups masking two hydroxyl groups and this would mean that it would be most strongly retained by a lipophilic stationary phase. Figure 12.4 shows the chromatogram obtained from the mixture of corticosteroids obtained using an ODS column with methanol/water (75:25) as the mobile phase indicating that the order of elution fits prediction. The lipophilicity of the steroids reflects their pharmaceutical uses since the more lipophilic esters are used in creams and ointments for enhanced penetration through the lipophilic layers of the skin. The order of elution of these steroids would be more or less reversed on a polar silica gel column, although chromatographic behaviour is usually more predictable on reverse-phase columns.

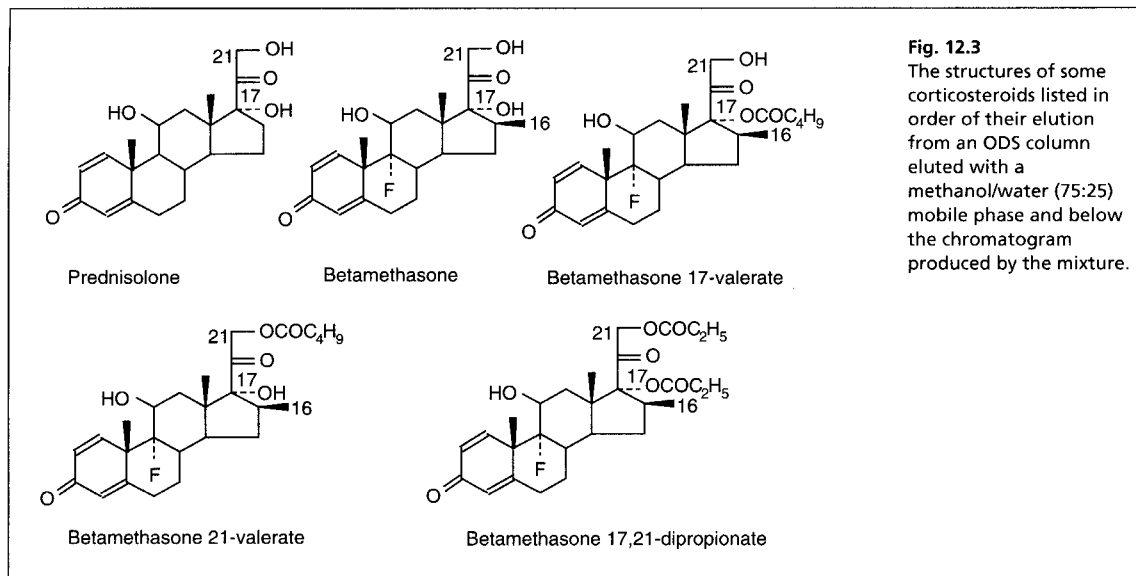

Fig. 12.3
The structures of some corticosteroids listed in order of their elution from an ODS column eluted with a methanol/water (75:25) mobile phase and below the chromatogram produced by the mixture.

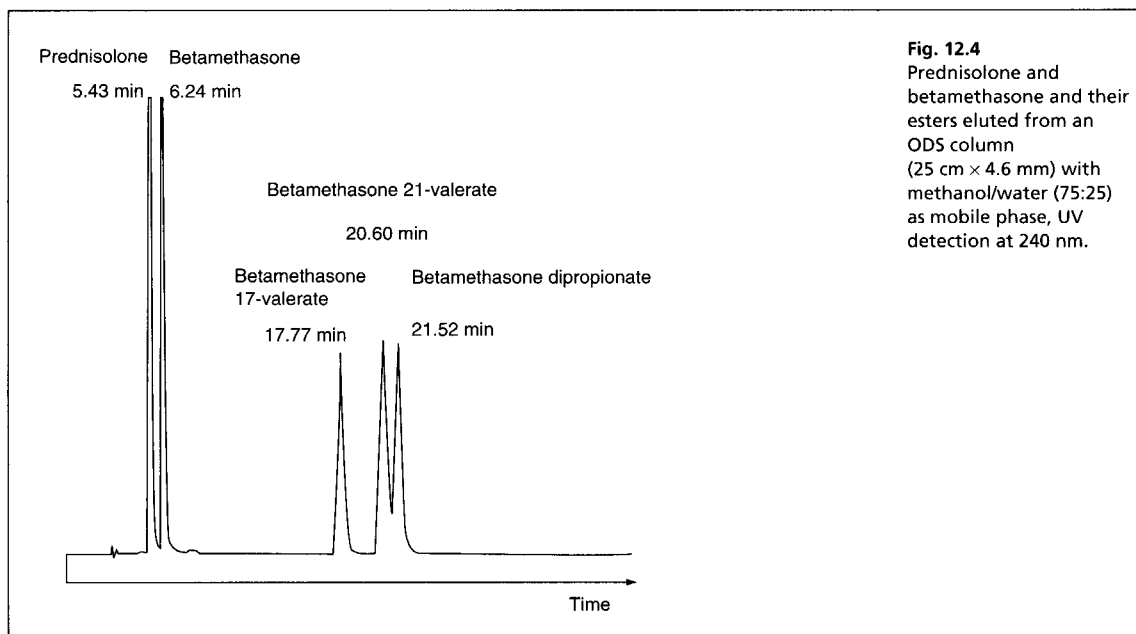

Fig. 12.4
Prednisolone and betamethasone and their esters eluted from an ODS column (25 cm × 4.6 mm) with methanol/water (75:25) as mobile phase, UV detection at 240 nm.

Considering the chromatogram shown in Figure 12.4 in more detail, the resolution between the betamethasone 21-valerate and the betamethasone dipropionate is incomplete, increasing the water content of the mobile phase would result in longer retention times for these two components and better separation, however, increasing the water content would also give very long retention times. If a formulation contained both the 21-valerate and 17,21-dipropionate, another type of column might be chosen to effect separation of these two components within a reasonable length of time, e.g. a silica gel column. If the betamethasone dipropionate were absent from

this mixture, a different separation strategy could be adopted to bring the valerate esters closer to betamethasone and prednisolone. It would not be possible to add more methanol to the mobile phase without losing resolution between betamethasone and prednisolone but after these two compounds had eluted, if an HPLC system with a binary or ternary gradient system were used, the instrument could be programmed to gradually increase the methanol content in the mobile phase to expedite the elution of the later running valerates. For example, a suitable solvent programme might be as follows:

methanol/water (75:25) for 7 min, then ramping the solvent composition to methanol/water (85:15) up to 17 min. This type of programme would greatly reduce the retention times of the valerates.

Self-test 12.2

Predict the order of elution, from first to last, of the following steroids from an ODS column with methanol/water (70:30) as the mobile phase.

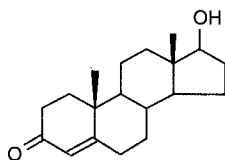

Testosterone

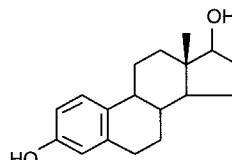

Oestradiol

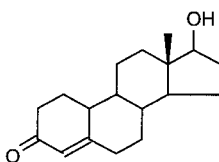

Nandrolone

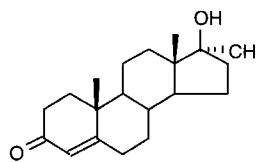

Methyltestosterone

Answer: oestradiol, nandrolone, testosterone, methyltestosterone

Control of elution rate of ionisable compounds by adjustment of pH of mobile phase

This area is not often considered in any detail in books on HPLC; however, pharmacists generally have a good grasp of the concept of pK_a and it is worth devoting some space to its effects in relation to HPLC. An additional factor which can be used to control the solvent strength of the mobile phase is pH; pH control is employed mainly in reverse-phase chromatography. However, mobile-phase conditions may be selected in straight-phase chromatography where the ionisation of the analytes is suppressed, and basic compounds are run in a basic mobile phase and acidic compounds are run with an acidic mobile phase. Control of the rate of elution via the pH of the mobile phase is of course only applicable to compounds in which the degree of ionisation is dependent on pH but this covers a majority of commonly used drugs. The pH of the mobile phase can only be set within the range of

ca 2–8.5 pH units because of the tendency for extremes of pH to dissolve silica gel and break the bonds between silane-coating agents and the silica gel support. This pH range is gradually being extended with the advent of more stable coatings. The effects of pH on retention time, suprisingly, are as yet not fully understood. The following examples give an approximation of the effect of the pH mobile phase on the retention time of drugs on a reverse-phase HPLC column, which provides a starting point for considering the effect of pH on retention time. In fact many drugs are still retained by lipophilic stationary phases to some degree even when they are fully ionised; in this case the drug is probably partitioning into the reverse phase as a lipophilic ion pair. The greatest effects of alteration of pH in the mobile phase are observed within 1 pH unit either side of the pKa value of the drug, i.e. where the partition coefficient of the partially ionised drug varies between 90% and 10% of the partition coefficient of the un-ionised drug (see Ch. 2, p. 29).

Calculation example 12.1

The effect of pH on the HPLC retention time of an ionisable acidic drug.

Ibuprofen, an acidic drug, which has a pKa of 4.4, is analysed by chromatography on ODS silica gel with a mobile phase consisting of acetonitrile/0.1 M acetate buffer pH 4.2 (40:60).

The t_o for the column at a mobile phase flow rate of 1 ml/min is 2.3 min. The retention time of ibuprofen at pH 4.2 is 23.32. If K'_{app} is the apparent capacity factor of the partially ionised drug, then K'_{app} at pH 4.2 = $23.32 - 2.3 / 2.3 = 9.14$.

Using the expression introduced in Chapter 2 for the effect of pH on partition coefficient of an acid, it is possible to predict approximately the effect of pH on retention time since the effect of pH on partition coefficient will reflect its effects on capacity factor and in theory:

$$K'_{app} = K'/1 + 10^{pH-pK_a}$$

Using the observed K'_{app} at pH 4.2: $9.14 = K'/1 + 10^{4.2-4.4} = K'/1.63$

$$K' = 9.14 \times 1.63 = 14.90$$

If ibuprofen is analysed using the same ODS column with the mobile phase now composed of acetonitrile/0.1 M acetate buffer at pH 5.2 (40:60) the partition coefficient will now be lowered as follows:

$$K'_{app} \text{ at pH } 5.2 = K'/1 + 10^{5.2-4.4} = 14.9/7.3.$$

$$K'_{app} \text{ at pH } 5.2 = 2.04.$$

$$\text{Retention time} = t_o + t_o \times K'_{app} = 2.3 + 2.3 \times 2.04 = 7.0 \text{ min.}$$

Experimentally, the retention time of ibuprofen was found in fact to be 12.23 min. This reflects the fact that the pKa of the drug may not be exactly as given in the literature under the conditions used for chromatography and the fact that the low dielectric constant of the mobile phase in comparison with water suppresses ionisation so that the drug is less ionised than predicted. However, the calculation gives a reasonable approximation of the behaviour of ibuprofen.

The same type of calculation shown in Calculation example 12.1 can be carried out for basic drugs. Figure 12.5 shows the structures of some local anaesthetic drugs with their pKa values.

Figure 12.6 shows the effect of the pH of the mobile phase on the four local anaesthetics shown in Figure 12.5. The largest effects of pH are on bupivacaine and pentycaine which are very close in structure; the pH adjustment made in the example is within ± 1 pH unit of their pKa values. The least effect is on procaine, which has a

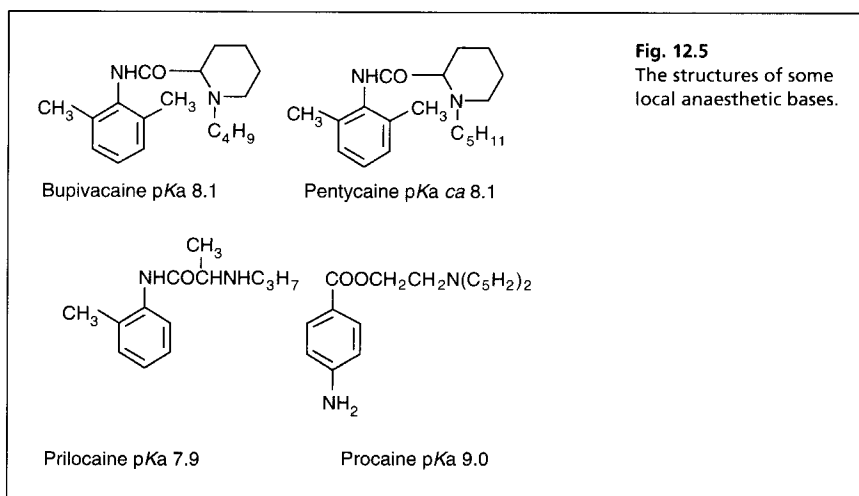

Fig. 12.5
The structures of some local anaesthetic bases.

Calculation example 12.2

The effect of pH on the HPLC retention time of an ionisable basic drug. Bupivacaine, which has a p*K*_a of 8.1, is analysed by chromatography on ODS silica gel with a mobile phase consisting of acetonitrile/TRIS buffer pH 8.4 (40:60) at a flow rate of 1 ml/min. The *t*₀ for the column at a mobile phase flow rate of 1 ml/min is 2.3 min. The retention time of bupivacaine at pH 8.4 is 17.32. If *K'*_{app} is the apparent capacity factor of the partially ionised drug, then for a base:

$$K'_{app} = K'/1 + 10^{pK_a - pH}$$

$$\text{The } K'_{app} \text{ at pH 8.4} = 17.82 - 2.3/2.3 = 6.75$$

$$6.75 = K'/1 + 10^{8.1 - 8.4} = K'/1.5$$

$$K' = 6.75 \times 1.5 = 10.13$$

If the drug were analysed using acetonitrile/TRIS buffer pH 7.4 (40:60) at a flow rate of 1 ml/min using the same column, the retention time can be estimated as follows:

$$K'_{app} \text{ at pH 7.4} = K'/1 + 10^{8.1 - 7.4} = 10.13/6.01$$

$$K'_{app} \text{ at pH 7.4} = 1.69$$

$$\text{Retention at pH 7.4 time} = t_0 + t_0 \times K'_{app} = 2.3 + 1.69 \times 2.3 = 6.18 \text{ min}$$

Experimentally, the retention time was found to be 10.80 min. The deviation from the theoretical value was probably due to the factors discussed earlier for ibuprofen.

higher p*K*_a (9.0) than the other drugs and is thus already 80% ionised at pH 8.4; for this reason, the lowering of the pH has a less marked effect on its retention time. The effect of pH on prilocaine might initially appear somewhat less than expected but this is because it is closer to *t*₀ than the other drugs; the decrease in its retention time observed at the lower pH is in fact in line with the decreases observed for bupivacaine and pentycaine. In chromatogram B, the procaine peak has lost some of its integrity due to its proximity to the solvent front; this results in poor trapping of the analyte at the head of the column. The effect of the organic content of the mobile phase on the p*K*_a of analytes is given some additional consideration in Box 12.1.

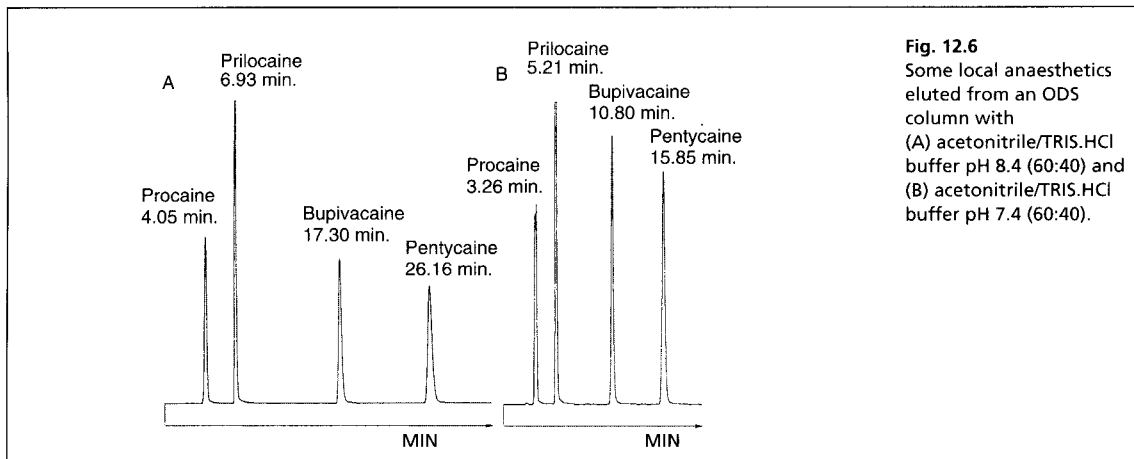

Fig. 12.6
 Some local anaesthetics eluted from an ODS column with (A) acetone/nitrile/TRIS.HCl buffer pH 8.4 (60:40) and (B) acetone/nitrile/TRIS.HCl buffer pH 7.4 (60:40).

Self-test 12.3

The retention time of the acidic drug naproxen on an ODS column with a t_0 of 2.3 minutes in a mixture containing acetone/nitrile/ 0.05 M acetate buffer pH 5.2 (40:60) is 9.07 minutes. The pK_a of naproxen is 4.2; what would be the effect of reducing the pH of the mobile phase to 4.2?

Answer: In theory, the retention time would be 39.47 min (in practice it was found to be 19.78 min. The pK_a of this drug is probably lower than the literature value under the mobile phase conditions used or it is less ionised at pH 5.2 than expected in the mobile phase, which has a lower dielectric constant than water)

Box 12.1 Additional considerations of mobile phase pH

A major factor which is often ignored in preparing mobile phases is the effect of the addition of organic solvent to the buffer. The effect of addition of acetone/nitrile on the pK_a value of acetic acid has been calculated to be as follows:⁶

Percentage of w/w acetone/nitrile:	0	10	30	40	50
pK_a value of acetic acid:	4.75	5.0	5.6	6.0	6.4

The addition of organic solvent thus suppresses the ionisation of the acid reducing the $[H^+]$ in solution and the overall effect is an increase in pH. The same effect can be observed for other buffers such as phosphate and citrate and with 50% organic solvent the effective pH of the mobile phase may be 1–1.5 units higher than the measured pH of the buffer before mixing.

Summary of stationary phases used in HPLC

The intention of this book is to focus mainly on applications of techniques to pharmaceutical analysis. Detailed discussions of stationary phases and detectors can be found elsewhere.^{1,2,4,5} Table 12.1 summarises some of the stationary phases which

are used in HPLC. Currently, ODS silica gel or related phases such as octyl silica gel are used for > 80% of all pharmaceutical analyses as judged from a comprehensive survey of the literature;³ other phases are only used where special selectivity is required, such as for very water-soluble compounds or for bioanalytical separations which may be critical because the sample matrix produces many interfering peaks. In recent years polymeric phases have become available for certain specialist applications; the surface chemistries of these phases are similar to those of the silica gel-based phases. Advantages of the polymeric phases are stability to extremes of pH and the lack of secondary interactions of analytes with uncapped silanol groups. Disadvantages include expense and a tendency to swell when in contact with lipophilic mobile phases, which can destroy them. Such phases are best used with predominantly aqueous-based mobile phases.

Table 12.1 Some commonly used HPLC stationary phases

Stationary phase	Applications/comments
ODS silica gel	The most commonly used phase, applicable to most problems in analysis of pharmaceutical formulations. Early phases gave problems with strongly basic compounds because of incomplete endcapping of silanol (Si-OH) groups. Amines adsorb strongly onto free silanol groups not covered by the stationary phase. Fully endcapped phases and phases with low metal content are now available, which enable the analysis of strongly basic compounds that formerly tended to produce tailing peaks. ODS silica gel can even be applied to the analysis of peptides, where wide-pore packings are used to improve access of these bulky molecules to the internal surface of the packings
Octyl silane and butyl silane silica gels	Useful alternatives to ODS phases. The shorter hydrocarbon chains do not tend to lead to shorter retention times of analytes since the carbon loading on the surface of the silica gel may be higher for these phases and retention time is also dependent on how much of the stationary phase is accessible to partitioning by the analyte ⁷
Phenyl silane silica gel	Useful for slightly more selective analyses of compounds containing large numbers of aromatic rings, e.g. propranolol and naproxen, where some additional interactions can occur with the phenyl groups on the stationary phase. These interactions are, however, very subtle
Silica gel	Often used in the past for problematical compounds but with gradual improvement of reverse phases increasingly less used. Useful for chromatography of very lipophilic compounds such as in the separation of different classes of lipids and in the analysis of surfactants, which tend to form micelles under the conditions used for reverse-phase chromatography
Aminopropyl silica gel	A moderately polar phase often used for the analysis of sugars and surfactants
Cyanopropyl silica gel	A moderately polar phase applicable to the analysis of surfactants
Strong cation exchanger (SCX)	Usually based on ion pairing of the analyte with sulfonic acid groups on the surface of the stationary phase. Useful for analysis of very polar compounds such as aminoglycosides and other charged sugar molecules and polar bases such as catecholamines
Strong anion exchanger (SAX)	Usually based on ion pairing of the analyte with quaternary ammonium groups on the surface of the stationary phase. Useful for the separation of polar compounds with anionic groups such as nucleotides and anionic drug metabolites such as sulphates or glucuronides

Summary of detectors used in HPLC

For the majority of analyses of drugs in formulations, variable wavelength UV or diode array UV detectors are used. A typical UV detector has a narrow cell about 1 mm in diameter with a length of 10 mm, giving it an internal volume of about 8 μl . The linear range of such detectors is between 0.0001 and 2 absorbance units and samples have to be diluted sufficiently to fall within the range. Although the exact concentration of a sample passing through the flow cell is not known, a suitable concentration can be approximated as shown in Calculation example 12.3.

Calculation example 12.3

A typical elution volume of chromatographic peak volume is 400 μl . If 20 μl (0.02 ml) of a solution containing paracetamol at a concentration of 1 mg/100 ml is injected into an HPLC system with a flow cell with a pathlength of 10 mm:

Amount of paracetamol injected = $1 \text{ mg} \times 0.02/100 = 0.0002 \text{ mg}$.

Mean concentration of paracetamol in the peak volume = $0.0002 \times 100/0.4 = 0.05 \text{ mg}/100 \text{ ml}$.

The $A(1\%, 1 \text{ cm})$ value for paracetamol at 245 nm is 668.

The absorbance of a 0.05 mg (0.00005 g) solution = $0.00005 \times 668 = 0.0334$.

The mean absorption across the peak would be 0.00334.

If the peak has a Gaussian shape, the maximum absorption for the peak would be *ca* 1.5 times the mean absorption, i.e. in this case 0.05 or 50 milliabsorbance units (mAU).

Selective detectors tend to be employed where the analyte is present in small amounts in a complex matrix such as in bioanalytical procedures where components extracted from the biological matrix along with the analyte can cause interference. Some formulated compounds have only very poor chromophores – these include: sugars, lipids, surfactants, amino acids and some classes of drugs, e.g. a number of anticholinergic drugs lack chromophores. In these cases an alternative to UV detection has to be employed.

Table 12.2 Some detectors commonly used in HPLC

Detector	Applications
Variable wavelength UV detector	Based on absorption of UV light by an analyte. A robust detector with good sensitivity works approximately in the range of 0.01–100 μg of a compound on-column. The sensitivity of the detector in part depends on the $A(1\%, 1 \text{ cm})$ value of the compound being analysed. The early detectors operated at a fixed wavelength (usually 254 nm); currently detectors are available which can be adjusted to operate at any wavelength over the full UV/visible range

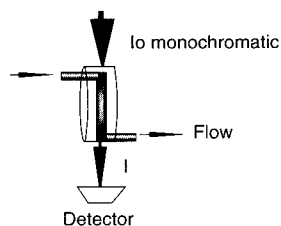

Table 12.2 Some detectors commonly used in HPLC (Cont.)

Detector	Applications
<p>Diode array detector (DAD)</p> 	<p>An advanced type of UV detector with the ability to monitor across the full UV range simultaneously using an array of photodiodes which detect light dispersed by a fixed monochromator over a range of wavelengths offering a resolution of ca 1 nm. Useful for complex mixtures containing compounds with widely different absorbance ranges and for mixtures where peaks overlap chromatographically but can be separated in terms of UV absorbance. The detector gives a full UV spectrum of each peak in the chromatogram which aids in identification of unknowns</p>
<p>Evaporative light scattering detector (ELSD)</p> 	<p>Detection is based on the scattering of a beam of light by particles of compound remaining after evaporation of the mobile phase. This detector is of growing importance; it is a universal detector and does not require a compound to have a chromophore for detection. Applications include the analysis of surfactants, lipids and sugars. Unlike the refractive index detector, which was formerly used for this analysis, it can be used with gradient elution and is robust enough to function under a wide range of operating conditions. However, it cannot be used with involatile materials such as buffers in the mobile phase or to detect very volatile analytes. Typical applications include: analysis of chloride and sodium ions in pharmaceuticals, lipids used as components in formulations, sugars and sugar polymers. Sensitive to ca 10 ng of analyte</p>
<p>Electrochemical detector</p> 	<p>The electrochemical detector is usually used in the coulometric mode. A fixed potential is applied between the working and reference electrode. Detection is based on production of electrons when the analyte is oxidised, which is the more common mode of operation, or consumption of electrons in the reductive mode. The current flowing across the detector cell between the working and auxiliary electrodes is measured. The working electrode that carries out the oxidation or reduction is usually made from carbon paste. Most applicable to selective bioanalyses such as the analysis of drugs in plasma, e.g. catechols such as adrenaline and thiol drugs such as the angiotensin-converting enzyme inhibitor captopril and the anti-rheumatic drug penicillamine</p>
<p>Pulsed amperometric detector</p>	<p>There is really no distinction between this detector and an electrochemical detector except that the detector has arisen largely as part of ion chromatography and tends to be used in the amperometric mode where conduction of current between two electrodes by an ionic analyte is measured rather than current changes resulting from oxidation or reduction of the analyte. The working electrode in this detector is usually gold rather than carbon paste. Highly sensitive to ionic compounds, the detector is used in ion chromatography for the analysis of inorganic ions such as phosphate and sulphate. Typical pharmaceutical applications include the analysis of cardenolides and aminoglycoside antibiotics which do not have chromophores. Sensitivity is typically down to 1 ng of analyte. Widely used in glycobiology for the analysis of sugar residues derived from glycoproteins. In the pulsed mode, the polarities of the electrodes are alternated in order to keep the electrode surfaces clean</p>

Table 12.2 Some detectors commonly used in HPLC (Cont.)

Detector	Applications
Refractive index detector (RI) 	Detection is based on changes of refractive index when the analyte passes through the sample cell (Samp.) in the detector, the reference cell (Ref.) being filled with the mobile phase. Like the ELSD, the RI detector is a universal detector with even less selectivity than the ELSD. It is very sensitive to mobile phase composition and temperature making it non-robust. It is still used as a universal detector since it is cheaper than an ELSD. Sensitive to ca 1 µg of compound
Fluorescence detector 	Detection is based on fluorescent emission following excitation of a fluorescent compound at an appropriate wavelength. A robust and selective detector applicable to compounds exhibiting fluorescence and to fluorescent derivatives. Most useful for selective bioanalyses. Sensitive to below the ng level for highly fluorescent compounds. Normally uses a Xenon lamp for excitation but instruments with high intensity deuterium lamps are available for excitation of short wavelength absorption bands

Self-test 12.4

Rank the following detectors in order of decreasing: a. Selectivity b. Robustness c. Sensitivity:

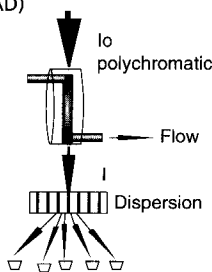
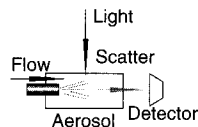
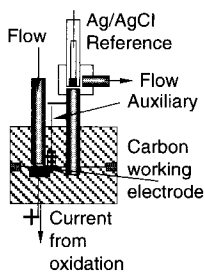
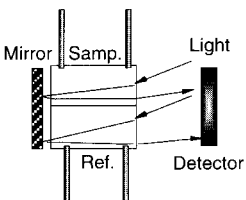
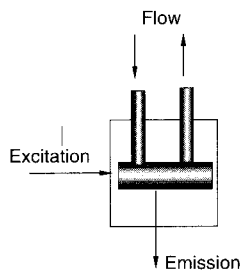
- (i) Variable wavelength UV detector.
- (ii) ELSD.
- (iii) RI detector.
- (iv) Electrochemical detector.

Answers: Selectivity: electrochemical detector, variable wavelength UV detector, ELSD, RI detector, Sensitivity: variable wavelength UV detector, ELSD, electrochemical detector, RI detector, Robustness: variable wavelength UV detector, ELSD, electrochemical detector, RI detector

Performance of a diode array detector (DAD)

Sometimes it is not possible to be completely confident that an HPLC has chromatographically resolved all the compounds in a sample and it might be suspected that a particular chromatographic peak might be due to more than one component. The DAD has developed into a tool of some sophistication for determining the purity of chromatographic peaks eluting from a HPLC column. Since a whole UV/visible spectrum is acquired several times across the width of a peak, this provides a means of checking the purity of the peak by checking for variations in the shape of the absorption spectrum across the chromatographic peak. Figure 12.7 illustrates four methods for looking at the purity of a peak using the information acquired by a DAD.

In the example illustrated in Figure 12.7, the spectrum of the apex of the peak (A) (where interference by impurities is likely to be the least) is compared with a spectrum from the leading edge of the peak (B). Comparison of individual spectra from anywhere across the width of the peak may also be made with a spectrum produced by combining each spectrum taken across the chromatographic peak to produce a composite spectrum for the peak. The four methods used are:

impurity absorbs intensely. If the peak is impure, the ratio will fall around where the impurity elutes. A pure peak will exhibit a fairly constant ratio across the width of the peak.

Applications of HPLC to the quantitative analysis of drugs in formulations

The majority of applications of HPLC in pharmaceutical analysis are to the quantitative determinations of drugs in formulations. Such analyses usually do not require large amounts of time to be spent optimising mobile phases and selecting columns and detectors so that analyses of complex mixtures can be carried out. A standard joke is that most quality control applications can be carried out with an ODS column and with methanol:water (1:1) as a mobile phase. Analyses of formulations are not quite that simple but compared to analysis of drugs in biological fluids or elucidation of complex drug degradation pathways, they present fewer difficulties. The main potential interferants in analysis of a formulation are preservatives, colourants (see Ch. 15) and possible degradation products of the formulated drug. Some formulations contain more than one active ingredient and these may present more of an analytical challenge since the different ingredients may have quite different chemical properties and elute at very different times from an HPLC column. In this case, achieving a short analysis time may be difficult. Since the emphasis in pharmaceutical analysis is on quantitative analysis of formulations, this will be considered first.

Analyses based on calibration with an external standard

HPLC assays of formulated drugs can often be carried out against an external standard for the drug being measured. The instrumentation itself is capable of high precision and in many cases drugs are completely recovered from the formulation matrix. If complete recovery can be guaranteed, then the area of the chromatographic peak obtained from a known weight of formulation can be compared directly with a calibration curve constructed using a series of solutions containing varying concentrations of a pure standard of the analyte. The use of a single point of calibration can also be justified since in quality control applications, the content of the formulation is unlikely to vary by $> \pm 10\%$ from the stated content. The Food and Drug Administration (FDA) have suggested that for an assay of the active ingredients in a formulation, calibration should be carried within a range of $\pm 20\%$ of the expected concentration in the sample extract. The steps required in a quantitative HPLC assay based on the use of an external standard are summarised as follows:

- Weigh accurately an analytical standard for the analyte and dissolve it in a precise volume of solvent to prepare a stock solution.
- Prepare appropriate dilutions from the stock to produce a calibration series of solutions so that (1) appropriate amounts of analyte are injected into the instrument giving consideration to its operating range and (2) the concentration of analyte which is expected in a diluted extract from the sample is at approximately the mid-point of the range of concentrations prepared in the calibration series.
- Inject the calibration solutions into the HPLC system starting with the lowest concentration and finishing with a blank injection of the mobile phase to check for carryover.
- Prepare the formulation for extraction, e.g. powder tablets, and weigh accurately portions of the prepared material.

- Extract the formulation with a solvent which is likely to give good extraction recovery and make up to a precise volume.
- Filter if necessary and take a precise aliquot of the sample extract and dilute this until its concentration falls at approximately the mid-point of the calibration series prepared using the analytical standard.
- Inject the diluted sample solution into the HPLC system. Replicates of the sample preparation and of the injection of the sample in HPLC may be carried out; sample preparation procedures are more likely to give rise to imprecision than instrumental variation.
- Plot a calibration curve for the area of the peaks obtained in the calibration series against the concentrations of the solutions. The peak areas given by integrators are in arbitrary units and may be to seven or eight figures. Assays are not usually precise beyond four significant figures, thus it may be appropriate to only consider the first five figures from the integrator output of any significance, e.g. 78993866 might be better considered as being 78994000.
- Check the linearity of the calibration curve, i.e. $r > 0.99$. Determine the concentration of the diluted sample extract from the calibration curve by substituting the area of its chromatographic peak into the equation for the calibration line.

Analysis of paracetamol tablets using a calibration curve

Tablets

Tablets contain paracetamol 500 mg, phenylpropanolamine 5 mg.

Explanation of the assay

Even without chromatographic resolution the small amount of phenylpropanolamine present in the formulation could be disregarded since its $A(1\%, 1\text{ cm})$ value at the wavelength 243 nm used for monitoring paracetamol is *ca* 4 compared to an $A(1\%, 1\text{ cm})$ of 668 for paracetamol. An ODS column retains paracetamol adequately if the amount of water in the mobile phase is high. Thus the mobile phase used is 0.05 M acetic acid/acetonitrile (90:15); the weakly acidic mobile phase ensures there is no tendency for the phenol group in paracetamol (pK_a 9.5) to ionise. The tablet extract has to be diluted sufficiently to bring it within the range of the UV detector. Figure 12.8 shows the chromatographic traces obtained for an extract from paracetamol tablets and a paracetamol standard (1.25 mg/100 ml) run using the system described above.

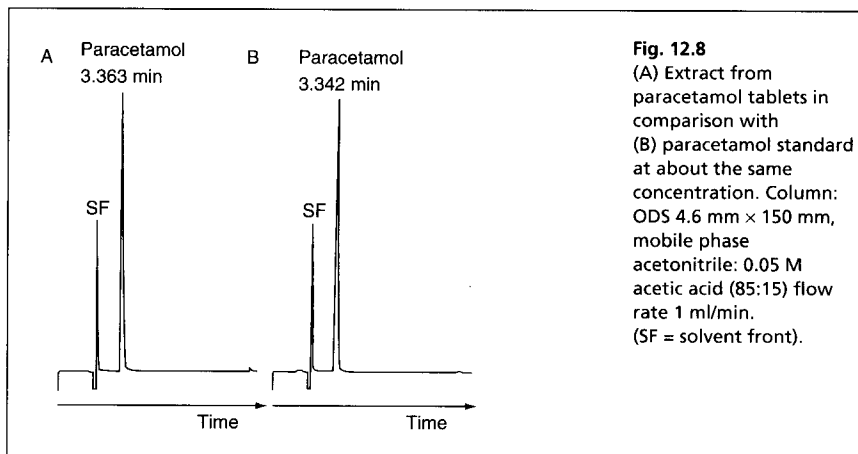

Assay

- (i) Weigh out 125 ± 10 mg of the paracetamol standard and transfer it to a 250 ml volumetric flask made up to volume with acetic acid (0.05 M) and shake well (stock solution).
- (ii) Prepare a series of solutions from the stock solution containing 0.5, 1.0, 1.5, 2.0 and 2.5 mg/100 ml of paracetamol.
- (iii) Weigh and powder 20 tablets.
- (iv) Weigh out tablet powder containing $125 \text{ mg} \pm 10 \text{ mg}$ of paracetamol.
- (v) Shake the tablet powder sample with *ca* 150 ml of acetic acid (0.05 M) for 5 min in a 250 ml volumetric flask and then adjust the volume to 250 ml with more acetic acid (0.05 M).
- (vi) Filter *ca* 50 ml of the solution into a conical flask and then transfer a 25 ml aliquot of the filtrate to 100 ml volumetric flasks and adjust the volume to 100 ml with acetic acid (0.05 M).
- (vii) Take 10 ml of the diluted extract and transfer to a further 100 ml volumetric flask and make up to volume with 0.05 M acetic acid.
- (viii) Analyse the standards and the extract using the chromatographic conditions specified earlier.

Data obtained

- Weight of 20 tablets = 12.1891 g
- Weight of tablet powder taken = 150.5 mg
- Weight of paracetamol calibration standard = 126.1 mg.

Table 12.3 Data obtained from the analysis of paracetamol standard solutions by HPLC

Concentration of paracetamol standard solution mg/100 ml	Area of chromatographic peak
0.5044	17 994
1.009	36 109
1.513	54 121
2.018	71 988
2.522	89 984

Area of paracetamol peak extracted from tablets = 45 205.

Calculate the percentage of the stated content of paracetamol in the tablet powder analysed.

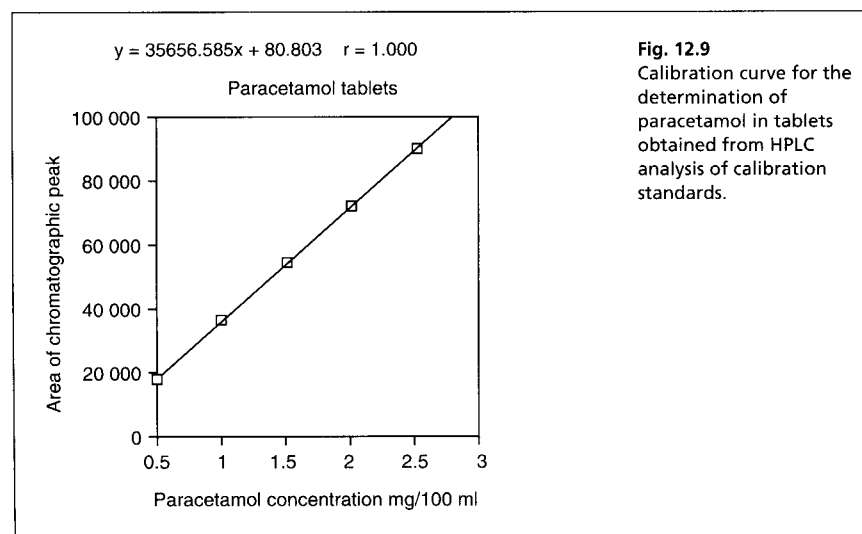

The graph shown in Figure 12.9 is obtained from the data given in Table 12.3; it is linear with $r = 1.000$.

The equation of the line can be used to calculate the amount of paracetamol in the diluted extract of the tablet powder.

Calculation example 12.4

Substituting the area obtained for the paracetamol peak obtained from the analysis of the tablet powder extract into the equation for the line:

$$45\,205 = 35\,656x + 80$$

Solving for x gives the concentration of the extract in mg/100 ml.

$$\text{Concentration of paracetamol in diluted tablet extract} = \frac{45\,205 - 80}{35\,656} = 1.266 \text{ mg/100 ml.}$$

Dilution steps

The dilution steps used were:

- 25 ml into 100 ml ($\times 4$)
- 10 ml into 100 ml ($\times 10$)
- Total = $\times 40$.

Concentration of paracetamol in undiluted tablet extract

$$1.266 \text{ mg/100 ml} \times 40 = 50.64 \text{ mg/100 ml.}$$

Amount of paracetamol in undiluted tablet extract

- The volume of the undiluted tablet extract = 250 ml
- Amount of paracetamol in 100 ml of the extract = 50.64 mg
- Amount of paracetamol in 250 ml of extract = $250/100 \times 50.64 \text{ mg} = 126.6 \text{ mg}$
- Amount of paracetamol found in the tablet powder assayed = 126.6 mg.

Amount of paracetamol expected in the tablet powder taken for assay

- Weight of 20 tablets = 12.1891 g
- Weight of one tablet = $12.1891/20 = 0.6094 \text{ g} = 609.5 \text{ mg}$
- Stated content per tablet = 500 mg
- Amount of paracetamol expected in the weight of tablet powder taken for assay = $150.5 / 609.5 \times 500 \text{ mg} = 123.5 \text{ mg}$.

Percentage of stated content

- Percentage of stated content = $126.6/123.5 \times 100 = 102.5\%$.

Self-test 12.5

Calculate the percentage of stated content in paracetamol tablets using the calibration curve given above and the following data:

Data

- Weight of 20 tablets = 12.2243 g
- Weight of tablet powder taken = 152.5 mg
- Stated content per tablet = 500 mg
- Initial extraction volume = 200 ml.

Dilution steps

- 20 ml into 100 ml
- 10 ml into 100 ml
- Area of chromatographic peak for paracetamol extracted from the tablets = 44 519.

ANSWER: 99.8%

Assay of paracetamol and aspirin in tablets using a narrow range calibration curve

Tablets

Tablets contain paracetamol 250 mg, aspirin 250 mg, codeine phosphate 6.8 mg.

Explanation of the assay

This problem is slightly more difficult than that posed by paracetamol tablets since there are two major active ingredients in the formulation. The codeine phosphate cannot be determined using the chromatographic system described here since it elutes from the column in the void volume and is obscured by the solvent front. Again an ODS column is quite suitable, and since aspirin is ionised extensively above pH 4.0, the pH of the mobile phase can be manipulated to move it to a region of the chromatogram where it can be run in the same mobile phase as paracetamol without its retention time being inconveniently long. Figure 12.10 shows the effect of mobile phase pH on the elution time of aspirin; the pK_a of paracetamol is much higher than that of aspirin and it is unaffected by the adjustment in pH of the mobile phase. The mobile phase which resulted in chromatogram B is preferred for the analysis.

Brief outline of the assay

The assay is more or less the same as that described for the paracetamol tablets except that the tablets are extracted with 0.05 M sodium acetate buffer pH 4.4. The calibration standard solutions are prepared so that they contain both aspirin and paracetamol in 0.05 M sodium acetate buffer pH 4.4 in the concentration range 1.0–1.5 mg/100 ml.

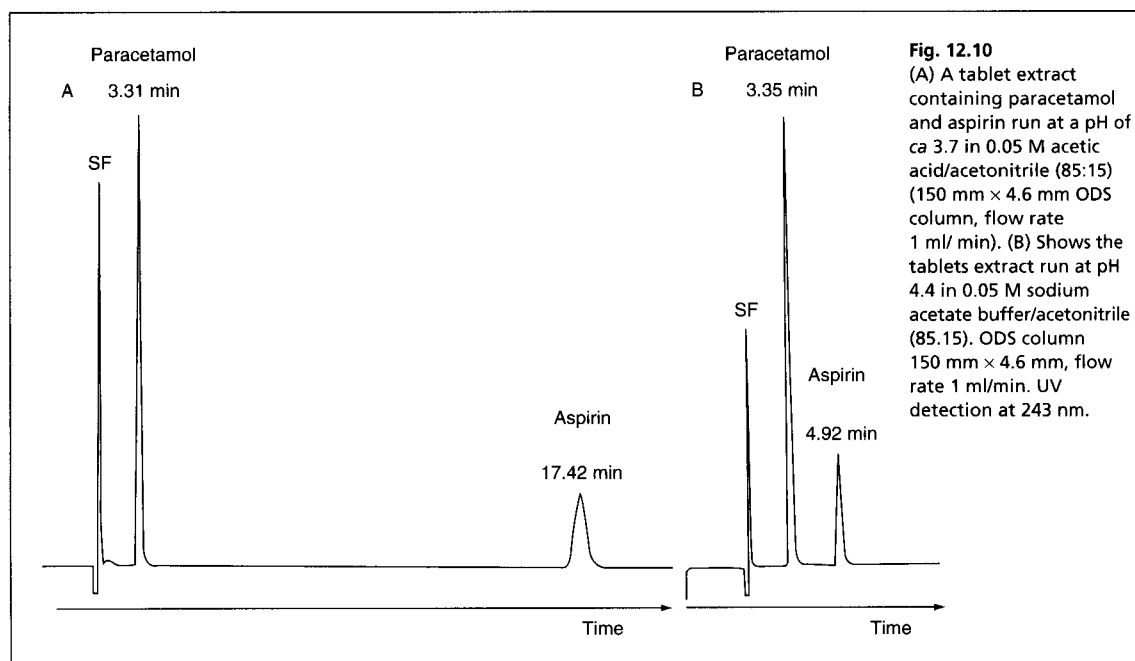

Data obtained

- Weight of 20 tablets = 11.2698 g
- Weight of tablet powder taken = 283.8 mg
- Weight of paracetamol standard = 125.5 mg
- Weight of aspirin standard = 127.3 mg.

Mean area of chromatographic peaks for a duplicate analysis of the tablet extract:

- Aspirin: 15 366
- Paracetamol: 44 535.

The equations for the calibration lines obtained were as follows:

- Aspirin: $y = 12\ 136 \times + 139$
- Paracetamol: $y = 35\ 374 \times - 35$.

Dilution of sample

- Initial volume in 250 ml.

Diluted:

- 25 to 100 ml
- 10 to 100 ml.

Self-test 12.6

Calculate the percentage of the stated content of aspirin and paracetamol in the tablet powder analysed using the data obtained above.

Answers: Paracetamol = 100.1% of stated content; aspirin = 99.7%

Assay of active ingredients in a linctus using a single point calibration for each analyte

Content per 5 ml of linctus

Pseudoephedrine hydrochloride 30 mg, triprolidine hydrochloride 1.25 mg, dextromethorphan bromide 10 mg and preservatives.

Explanation of the assay

This assay is altogether more difficult since three active ingredients are involved and several excipients interfere in the analysis, including one major excipient (methylparaben), which is not removed in the extraction process. In addition the active ingredients are bases which have a tendency to interact with any uncapped silanol groups in the stationary phase and it is essential to use a column which is deactivated with respect to the analysis of basic compounds. The three active ingredients are all at different concentrations in the formulation so that attention has to be paid to selection of a detection wavelength at which each component can be detected. In this particular assay a DAD would be useful.

Brief outline of the assay

The linctus is sugar free so that it is sufficiently non-viscous to be measured with a pipette rather than weighed. An aliquot of the linctus (5 ml) is made basic by addition of 1 ml of 10 M ammonia solution. The aqueous layer is extracted with

2 × 10 ml of chloroform. The chloroform layers are combined and evaporated to dryness using a rotary evaporator. The residue is dissolved in *ca* 10 ml of methanol and transferred to a 100 ml volumetric flask and then diluted to volume with mobile phase. The areas of the peaks obtained from the linctus extract are compared with a solution containing pseudoephedrine.HCl, dextromethorphan.HBr and triprolidine.HCl (structures shown in Fig. 11.14) at the same concentrations as would be expected in the linctus extract.

Figure 12.11 shows the chromatogram of the linctus extraction; the eluent was monitored at 260 nm. This analysis illustrates some of the difficulties of analysing a more complex formulation and is by no means definitive. The main criticism of the chromatogram shown in Figure 12.11 is that the shape of the dextromethorphan peak is not perfect and it is incompletely resolved from the methylparaben. The pseudoephedrine peak elutes quite close to the void time of 2.3 min and although it is present in largest amount in the formulation (30 mg/5 ml) it produces a relatively small peak in terms of area because its $A(1\%, 1\text{ cm})$ value at 260 nm is only 12. Dextromethorphan produces a slightly tailing peak due to interaction with uncapped silanol groups; this interaction is less at lower pH values. The $A(1\%, 1\text{ cm})$ value of dextromethorphan at 260 nm is *ca* 30. Triprolidine produces a peak with a reasonable shape, probably because it is a weaker base (pK_a 6.5) than dextromethorphan (pK_a 8.5), and this also accounts for its longer retention time since it is less ionised at pH 6.8 than dextromethorphan. The $A(1\%, 1\text{ cm})$ value of triprolidine at 260 nm is *ca* 250 which accounts for the large area of its chromatographic peak despite the fact that it is the least abundant component in the formulation (the GC analysis of the active ingredients in this formulation is less problematical, see Ch. 13 p. 217). The data obtained are shown below.

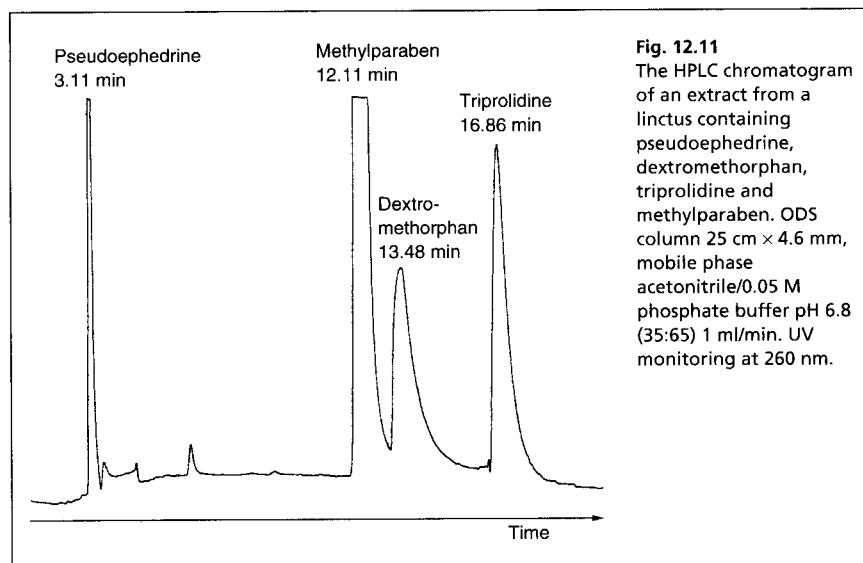

Fig. 12.11
The HPLC chromatogram of an extract from a linctus containing pseudoephedrine, dextromethorphan, triprolidine and methylparaben. ODS column 25 cm × 4.6 mm, mobile phase acetonitrile/0.05 M phosphate buffer pH 6.8 (35:65) 1 ml/min. UV monitoring at 260 nm.

Data obtained

- Volume of elixir extracted = 5 ml
- Final volume of extract = 100 ml
- Calculate the percentage of stated content for the triprolidine.HCl in the formulation.

Standard + concentration	Area of peak in standard	Area of peak in sample
Pseudoephedrine.HCl 31.23 mg/100 ml	325 178	318 915
Dextromethorphan.HBr 10.51mg/100 ml	479 918	469 293
Tripolidine.HCl 1.254 mg/100 ml	643 793	627 158

Calculation example 12.5

From simple ratio:

$$\text{Concentration of pseudoephedrine.HCl in extract} = 31.23 \times \frac{318\,915}{325\,178} = 30.63 \text{ mg/100 ml.}$$

5 ml of elixir were extracted to produce 100 ml of extract solution.

5 ml of elixir are stated to contain 30 mg of tripolidine.

$$\text{Percentage of stated content} = \frac{30.63}{30.0} \times 100 = 102.1\%.$$

Self-test 12.7

Calculate the percentage of stated content of: (i) tripolidine.HCl; and (ii) dextromethorphan.HBr in the elixir.

Answers: (i) 97.73%; (ii) 102.8%

Assays using calibration against an internal standard

If the recovery in an assay is good and the instrumentation used for measurement of the sample is capable of high precision, the use of an internal standard is not necessary. HPLC instrumentation is usually capable of high precision but for certain samples, recoveries prior to injection into the HPLC may not be accurate or precise. Examples of formulations in which recoveries may not be complete include ointments and creams, which require more extensive extraction prior to analysis. Problems of recovery are also typical of advanced drug delivery systems, which may be based on polymeric matrices in which a drug is dispersed. An internal standard is a compound related to the analyte (the properties required for an internal standard are summarised later), which is ideally added to the formulation being analysed prior to extraction. Quantification is achieved by establishing a response factor for the analyte relative to the internal standard, i.e. a ratio for the areas of the chromatographic peaks obtained for equal amounts of the analyte and internal standard; ideally this should be close to 1 for equal amounts of analyte and internal standard. The response factor may be based on a single-point calibration or a full calibration curve may be constructed; all the BP assays of this type are based on single-point calibrations. Once a response factor has been established the sample is extracted with a solution containing the *same* concentration of internal standard as was used in determining the response factor (or a solution which after dilution will yield an extract in which the internal standard is at the same concentration as in the calibration solution). Provided the solution containing the fixed concentration of

internal standard is added to the sample in a precisely measured volume, any subsequent losses of sample are compensated for since losses of the analyte will be mirrored by losses of the internal standard. The example given in Box 12.3 is typical of a BP assay incorporating an internal standard.

Box 12.2 Properties of an internal standard

- Ideally should be closely related in structure to the analyte
- Should be stable
- Should be chromatographically resolved from the analyte and any excipients present in the chromatogram of the formulation extract
- Should elute as close as possible to the analyte with the restrictions above
- For a given weight should produce a detector response similar to that produced by the analyte

Assay of hydrocortisone cream with one-point calibration against an internal standard

Explanation of the assay

Excellent separations of corticosteroids can be achieved on an ODS column with a suitable ratio of methanol/water as an eluent. In this assay hydrocortisone is quantified using betamethasone as an internal standard. The structure of betamethasone is close to that of hydrocortisone but since it is more lipophilic it elutes from the ODS column after hydrocortisone (Fig. 12.12). The assay is a modification of the BP assay for hydrocortisone cream. In the assay described here the internal standard is added at the first extraction step rather than after extraction has been carried out in order to ensure that any losses in the course of sample preparation are fully compensated for. Extraction is necessary in the case of a cream because the large amount of oily excipients in the basis of the cream would soon clog up the column if no attempt was made to remove them. The corticosteroids are sufficiently polar to remain in the methanol/water layer as they have a low solubility in hexane, while the oily excipients are removed by extraction into hexane. The sodium chloride (NaCl) is included in the sample extraction solution to prevent the formation of an emulsion when the extract is shaken with hexane. Solution 2, where the internal standard is omitted, is prepared in order to check that there are no excipients in the sample which would interfere with the peak due to the internal standard.

Brief outline of the assay

- Prepare a mixture of methanol/15% aqueous NaCl solution (2:1).
- Prepare Solution 1 as follows:
 - Mix together 10 ml of a 0.1% w/v solution of hydrocortisone and add 10 ml of a 0.1% w/v solution of betamethasone in methanol (internal standard solution)
 - Add 20 ml of methanol and then add water to dilute the solution to 100 ml.
- Prepare Solution 2 as follows:
 - Disperse cream containing *ca* 10 mg of hydrocortisone in 30 ml of the methanol/NaCl solution + 10 ml of methanol

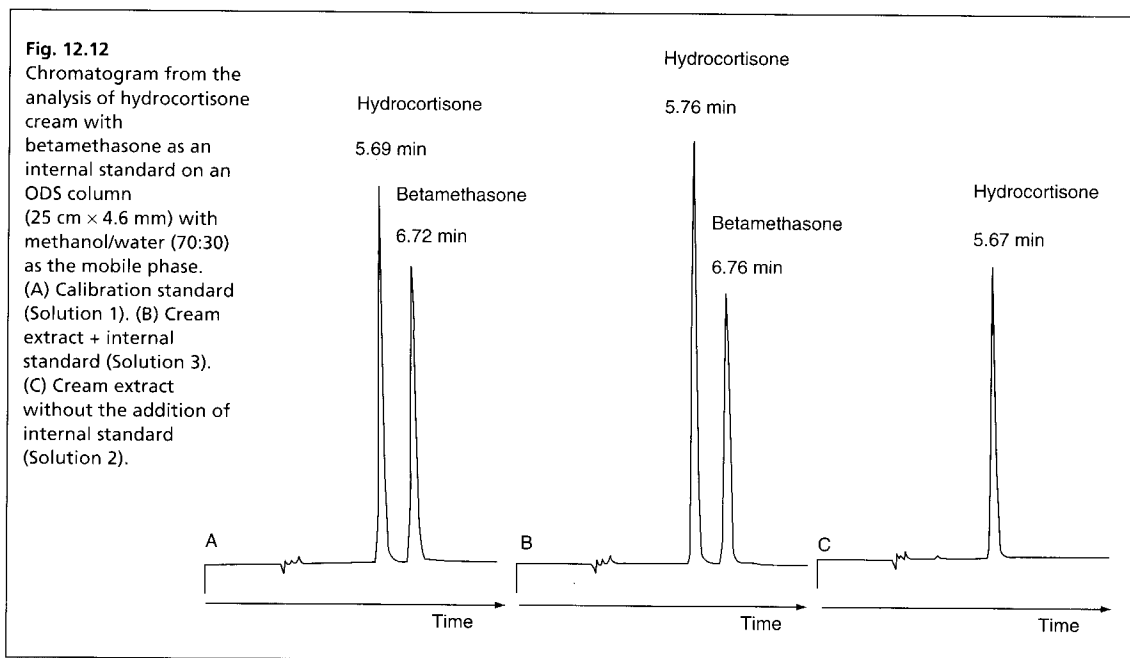

- Extract the dispersed cream with warm hexane (50 ml)
 - Remove the lower layer (methanol water layer) and wash the hexane layer with 2×10 ml of the methanol/NaCl solution combining the washings with the original extract
 - Dilute the extract to 100 ml with water.
- (iv) Prepare Solution 3 as follows:
- Repeat the procedure used in preparing Solution 2 except in the initial step, use 30 ml of methanol/NaCl solution + 10 ml of the betamethasone internal standard solution.
 - Analyse the solutions using a mobile phase containing methanol/water (70:30) and an ODS column.
 - Set the UV detector at 240 nm.

The calculation carried out from the data obtained in the assay described above uses response factors for the sample and standard (Box 12.3).

Data obtained

- Stated content of hydrocortisone cream = 1% w/w
- Weight of hydrocortisone cream used to prepare solution 3 = 1.173 g
- Area of hydrocortisone peak in Solution 1 = 103 026
- Area of betamethasone peak in Solution 1 = 92 449
- Area of hydrocortisone peak in Solution 3 = 113 628
- Area of betamethasone peak in Solution 3 = 82 920
- Concentration of hydrocortisone in the solution used in the preparation of Solution 1 = 0.1008% w/v
- Concentration of betamethasone used in preparation of Solutions 1 and 3 = 0.1003% w/v.

Box 12.3 Response factors

Assays based on the use of an internal standard use response factors to compare the sample solution with the calibration solution. In this case a simple one-point calibration is used. The concentration of betamethasone can be ignored since it is the same in Solutions 1 and 3; it should usually be the case that the same concentration of internal standard is present in the calibration and sample solutions. If this is the case then for the assay described above:

Response factor for Solution 1 (calibration solution)

$$= \frac{\text{area of hydrocortisone peak in Solution 1}}{\text{area of betamethasone peak in Solution 1}}$$

Response factor for Solution 3 (sample solution)

$$= \frac{\text{area of hydrocortisone peak in Solution 3}}{\text{area of betamethasone peak in Solution 3}}$$

The amount of hydrocortisone in the cream can be calculated as follows:

Concentration of hydrocortisone in Solution 3 =

$$\frac{\text{Response factor for Solution 3}}{\text{Response factor for Solution 1}} \times \text{concentration of hydrocortisone in Solution 1} \\ \times \frac{\text{volume of Solution 3}}{100}$$

Calculation example 12.6

Solution 1 is prepared by diluting 10 ml of a 0.1008% w/v solution of hydrocortisone to 100 ml.

Dilution $\times 10$.

$$\text{Concentration of hydrocortisone in Solution 1} = \frac{0.1008}{10} = 0.01008\% \text{ w/v.}$$

$$\text{Response factor for Solution 1} = \frac{103\,026}{92\,449} = 1.1144.$$

$$\text{Response factor Solution 3} = \frac{113\,628}{82\,920} = 1.3703.$$

$$\text{Concentration of hydrocortisone in Solution 3} = \frac{1.3703}{1.1144} \times 0.01008 = 0.01239\% \text{ w/v} = 0.01239 \text{ g/100 ml.}$$

$$\text{Amount of hydrocortisone in Solution 3} = \frac{\text{volume of Solution 3}}{100} \times \text{weight of hydrocortisone/100 ml.}$$

The volume of Solution 3 = 100 ml.

$$\text{Amount of hydrocortisone in Solution 3} = \frac{100}{100} \times 0.01239 = 0.01239 \text{ g.}$$

Weight of hydrocortisone cream analysed = 1.173 g.

$$\text{Percentage of w/w of hydrocortisone in cream} = \frac{0.01239}{1.173} \times 100 = 1.056\% \text{ w/w.}$$

Stated content of hydrocortisone in the cream = 1% w/w.

$$\text{Percentage of stated content} = \frac{1.056}{1} \times 100 = 105.6\%.$$

The cream conforms to the BP requirement that it should contain between 90–110% of the stated content.

Self-test 12.8

Betamethasone valerate is analysed in a sample of ointment used for treating haemorrhoids, the related steroid beclomethasone dipropionate is used as an internal standard. The following data were produced:

- Stated content of betamethasone valerate in ointment = 0.05% w/w
- Weight of ointment analysed = 4.3668 g
- Area of betamethasone valerate peak in Solution 1 (calibration solution) = 89 467
- Area of beclomethasone dipropionate in Solution 1 = 91 888
- Area of betamethasone valerate peak in Solution 3 = 87 657
- Area of beclomethasone dipropionate peak in Solution 3 = 90 343
- Concentration of betamethasone valerate present in the calibration solution = 0.004481% w/v
- Concentration of beclomethasone dipropionate in the calibration solution and in the sample extract solution = 0.00731% w/v (Note: if this is the same in both the calibration and sample solutions, it can be ignored)
- Volume of sample extract = 50 ml.

Calculate the % w/w of betamethasone valerate in the cream

Answer: 0.05113% w/w

Assay of miconazole cream with calibration against an internal standard over a narrow concentration range

Explanation of the assay

In this case the selective extraction of oily excipients from the cream is made somewhat easier by the fact that the miconazole (pK_a 6.5) is almost fully ionised at pH 4.0; the econazole internal standard used differs from miconazole by only one chlorine atom (Fig. 12.13). Thus a preliminary extraction can be made with hexane to remove much of the basis of the ointment and then the sample can be simply diluted with mobile phase, filtered and analysed.

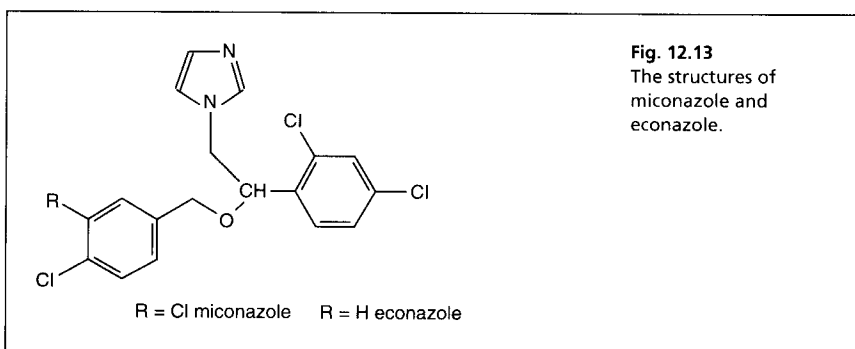

Fig. 12.13
The structures of miconazole and econazole.

Brief outline of the assay

A chromatographic mobile phase consisting of acetonitrile/0.1 M sodium acetate buffer pH 4.0 (70:30) is prepared. Separate stock solutions in 250 ml of chromatographic mobile phase containing miconazole nitrate (200 ± 20 mg) and econazole nitrate (200 ± 20 mg) (internal standard) are prepared. 25 ml of econazole nitrate stock solution is transferred to five 100 ml volumetric flasks and varying amounts of miconazole stock solution: 15, 20, 25, 30 and 35 ml are added to the five flasks. The flasks containing the calibration series are diluted to volume with mobile phase. A sample of cream containing 20 mg miconazole nitrate is shaken with 25 ml

of the stock solution of econazole nitrate for 5 min. The sample is then extracted with 50 ml of hexane, and the hexane layer is removed and discarded. Nitrogen gas is then blown through the solution for a few minutes to remove residual hexane and the solution is then transferred to a 100 ml volumetric flask, diluted to volume with mobile phase and a portion (20 ml) is filtered prior to analysis. The detection wavelength used is 220 nm since miconazole and econazole lack strong chromophores. On a 15 cm × 4.6 mm ODS column at a flow rate of 1 ml/min, econazole elutes at *ca* 6 min and miconazole elutes at *ca* 10 min; the extra chlorine atom in the structure of miconazole increases its lipophilicity considerably.

Data obtained

- Weight of miconazole used to prepare stock solution = 201.5 mg
- Weight of cream taken for assay = 1.0368 g
- Area of miconazole peak obtained from sample = 119 923
- Area of econazole peak obtained from sample = 124 118.

Table 12.4

Concentration of miconazole in calibration solution mg/100 ml	Area of miconazole peak	Area of econazole peak	Area miconazole / Area econazole
12.09	70 655	123 563	0.5718
16.12	96 218	125 376	0.7674
20.15	119 793	126 783	0.9449
24.18	151 310	127 889	1.183
28.21	166 673	125 436	1.329

The equation of the line obtained from the above data $y = 0.048x - 0.006$; $r = 0.998$.

Self-test 12.9

Calculate the percentage of w/v of miconazole in the cream from the data obtained above.

Answer: 1.954% w/v

Assays involving more specialised HPLC techniques

Although more than 80% of all separations by HPLC utilise reverse-phase chromatography, there are certain analytes which require more specialised chromatographic methods. A few examples are given in the following section.

Assay of adrenaline injection by chromatography with an anionic ion-pairing agent

Explanation of the assay

Injections of local anaesthetics often contain low concentrations of adrenaline in order to localise the anaesthetic for a time by constricting blood vessels in the vicinity of the injection. Adrenaline can be analysed by straight-phase chromatography, for instance on silica gel, but this generally requires strongly basic conditions under which the catechol group in adrenaline is unstable. Adrenaline is

not retained by reverse-phase columns and elutes in their void volume. A commonly used technique for the analysis of adrenaline and other highly water-soluble amines is ion pair chromatography. This can be viewed essentially as the generation of an ion exchange column in situ. The process is illustrated in Figure 12.14 where sodium octanesulphonic acid (SOSA) is added to the mobile phase (e.g. sodium phosphate buffer 0.1 M/methanol 9:1 containing 0.02% SOSA); the SOSA partitions into the lipophilic stationary phase and saturates it. The stationary phase is then able to retain adrenaline by electrostatic interaction. Elution occurs by a combination of displacement of adrenaline from its ion pair by sodium ions and by migration of the ion pair itself in the mobile phase. An additional benefit of using an ion-pairing reagent, rather than resorting to straight-phase chromatography, is that the organic solvent content in the mobile phase can be kept low, thus enabling the use of an electrochemical detector, which works best in mobile phases with a low content of organic solvent and which is highly selective for the readily oxidised catechol groups of adrenaline.

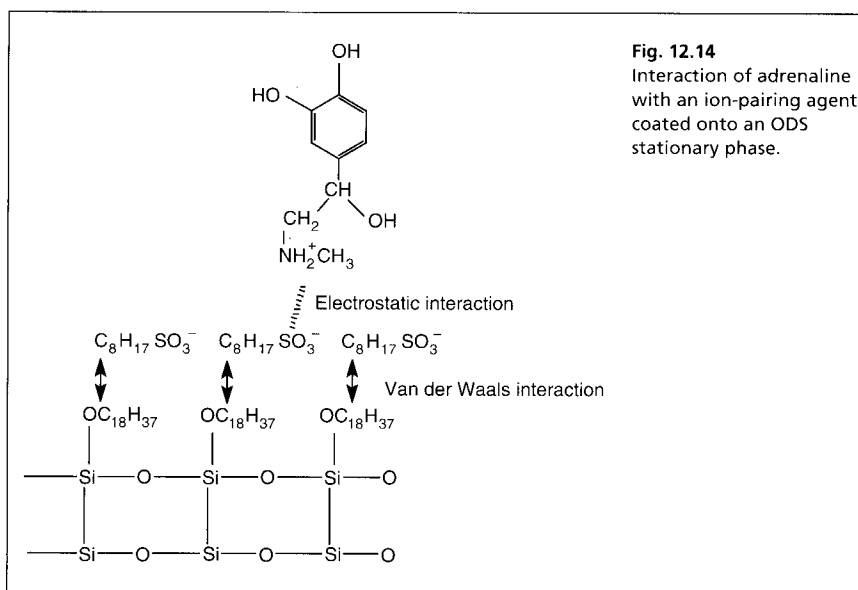
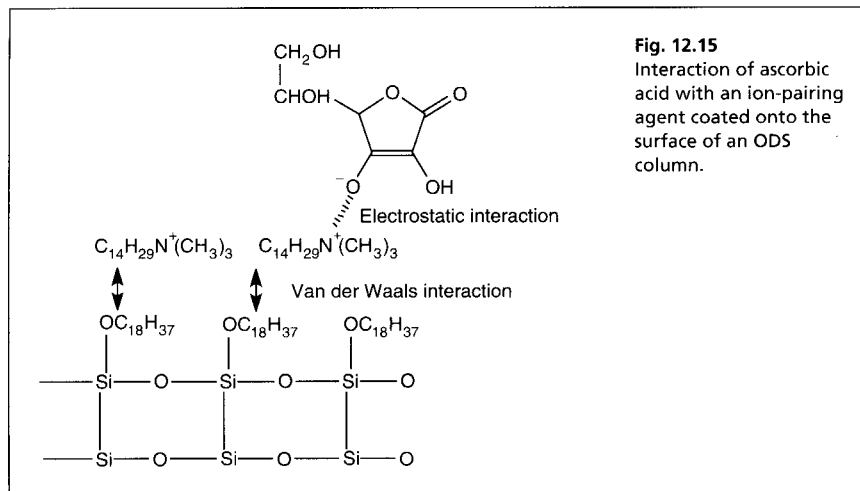

Fig. 12.14
Interaction of adrenaline with an ion-pairing agent coated onto an ODS stationary phase.

Assay of ascorbic acid by chromatography with a cationic ion-pairing agent and electrochemical detection

Ascorbic acid is highly polar and is not retained by reverse-phase columns. One technique for retaining it on a reverse-phase column is to use a cationic ion-pairing reagent. In the example given in Figure 12.15, cetrимide is used as the ion-pairing reagent in the mobile phase (e.g. 0.1 M sodium acetate buffer pH 4.2/acetonitrile 95:5 containing 0.03 M cetrимide). Again the low organic solvent content of the mobile phase enables monitoring with an electrochemical detector. Selectivity is important in the determination of ascorbic acid because it is often present in multivitamin formulations and as a preservative in pharmaceutical formulations containing other components in large amounts.



Assay of proteins with wide-pore HPLC packings

For large molecules such as peptides, chromatographic packings have to be used with wide pores to facilitate partitioning of the large structures into the stationary phase. Typically ODS packings with $0.0003 \mu\text{m}$ pores are used. The 1993 BP assay for human insulin is based on this type of packing. The chromophores in proteins are usually not particularly strong so that UV detectors are set at short wavelengths. The mobile phases used are similar to those used for chromatography of small molecules on ODS columns. The mobile phase used in the BP analysis of insulin is composed of a mixture of phosphate buffer pH 2.3 and acetonitrile and detection is carried out with the wavelength of the UV detector set at 214 nm. Peptide drugs may be contaminated with closely related peptides, which may differ by only one or two amino acids from the main peptide but may have high biological potency even when they are present in small amounts. The BP assay of human insulin includes at test for the presence of porcine insulin, which differs from human insulin by only one amino acid out of 30. The monograph stipulates that there should be a resolution of at least 1.2 between the peaks for human and porcine insulin when a test solution containing equal amounts of the two insulins is run.

Proteins may differ widely in lipophilicity depending on their amino acid composition. In the literature example shown in Figure 12.16, the reproducibility of three batches of a 300 \AA ODS packing for the separation of a mixture of proteins was studied.⁸ The mobile phase used was the popular system for protein analysis utilising gradient elution with aqueous trifluoroacetic acid and acetonitrile with gradually increasing acetonitrile content. Under these conditions the most lipophilic proteins elute last.

Another method used for eluting proteins from an ODS column is via the salting out effect, where mobile phase gradient is run from high to low salt concentration; again the most lipophilic proteins elute last.

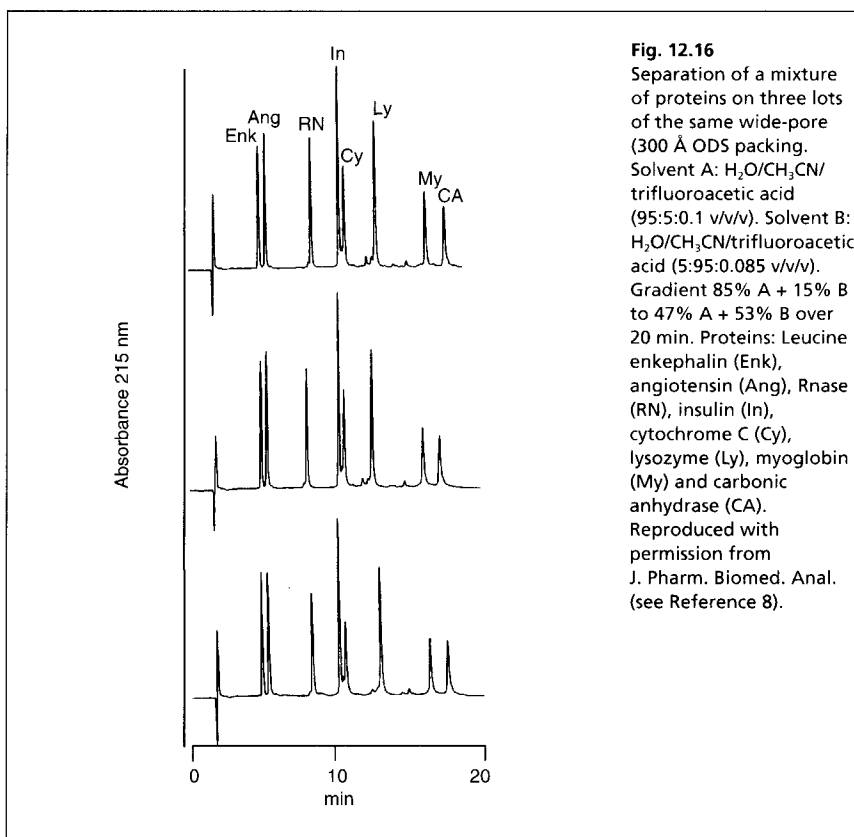

Assay of hyaluronic acid by size exclusion chromatography

Polymeric materials have a number of pharmaceutical applications. Hyaluronic acid is a high molecular weight polymeric carbohydrate (Fig. 12.17) which has excited much interest in recent years because properties such as the promotion of wound healing are attributed to it. It is also used as a surgical aid during surgery to remove cataracts. In recent years, high performance gel filtration columns containing rigid beads of porous polymers have become available for determination of high molecular weight analytes. The retention mechanism in size exclusion or gel permeation chromatography (GPC) is based on the extent to which an analyte enters pores within the stationary phase (Fig. 12.18). The largest molecules are completely excluded from the internal space of the column and elute from the column first. Columns with varying pore sizes are available and for hyaluronic acid a large pore size is required since the polymer has a molecular weight $> 10^6$ Daltons. In order to determine molecular weights, such columns are calibrated with polymeric standards of known molecular weight, although corrections related to the viscosity of the analyte have to be made when one type of polymer is used for calibrating a column used in order to determine the molecular weight of a different type of polymer because of differences in three-dimensional shape.

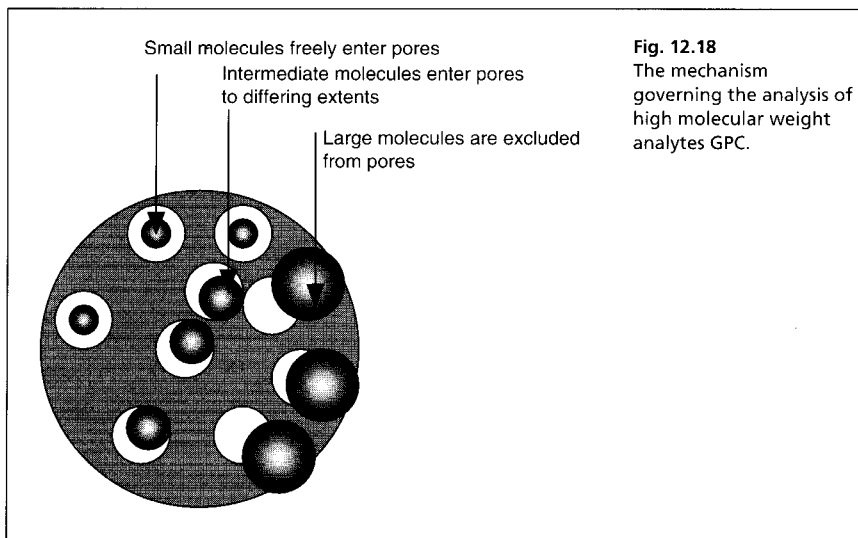
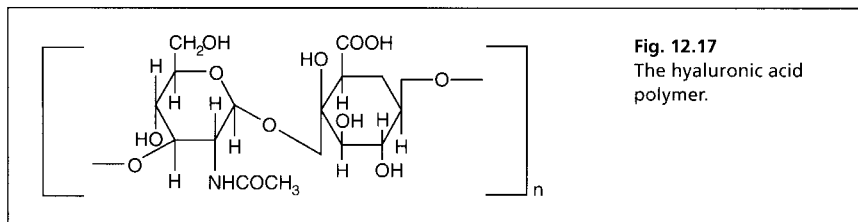

Typically such an assay can be carried out using a column packed with an aqueous compatible porous polymer with a mobile phase consisting of, for example, 0.05 M sodium sulphate solution. Hyaluronic acid exhibits some weak UV absorption due to its N-acetyl groups at short wavelengths and UV monitoring of the eluent can be carried out at *ca* 215 nm. Alternatively a refractive index detector or an ELSD can be used to monitor the eluent for polymers exhibiting no UV absorption at all. GPC of lipophilic polymers can be conducted in the same way using polymeric phases which are compatible with organic solvents.

Analysis of non-ionic surfactants with an ELSD and gradient elution

Non-ionic surfactants are used in formulations to solubilise drugs with poor water solubility; these compounds consist in their simplest form of an alkyl group attached to a polyethylene glycol chain. Non-ionic surfactants are usually mixtures, e.g. Cetomacrogol 1000, which has the general formula:



where *m* is 15 or 17 and *n* is 20 to 24. These compounds are amphiphilic and have affinity for water and organic solvents. Their analysis by HPLC requires a universal detector which does not require substances to have a chromophore in order to detect them. Formerly RI detectors were used for this type of analysis but the ELSD allows gradient elution to be used, which is advantageous where complex mixtures contain

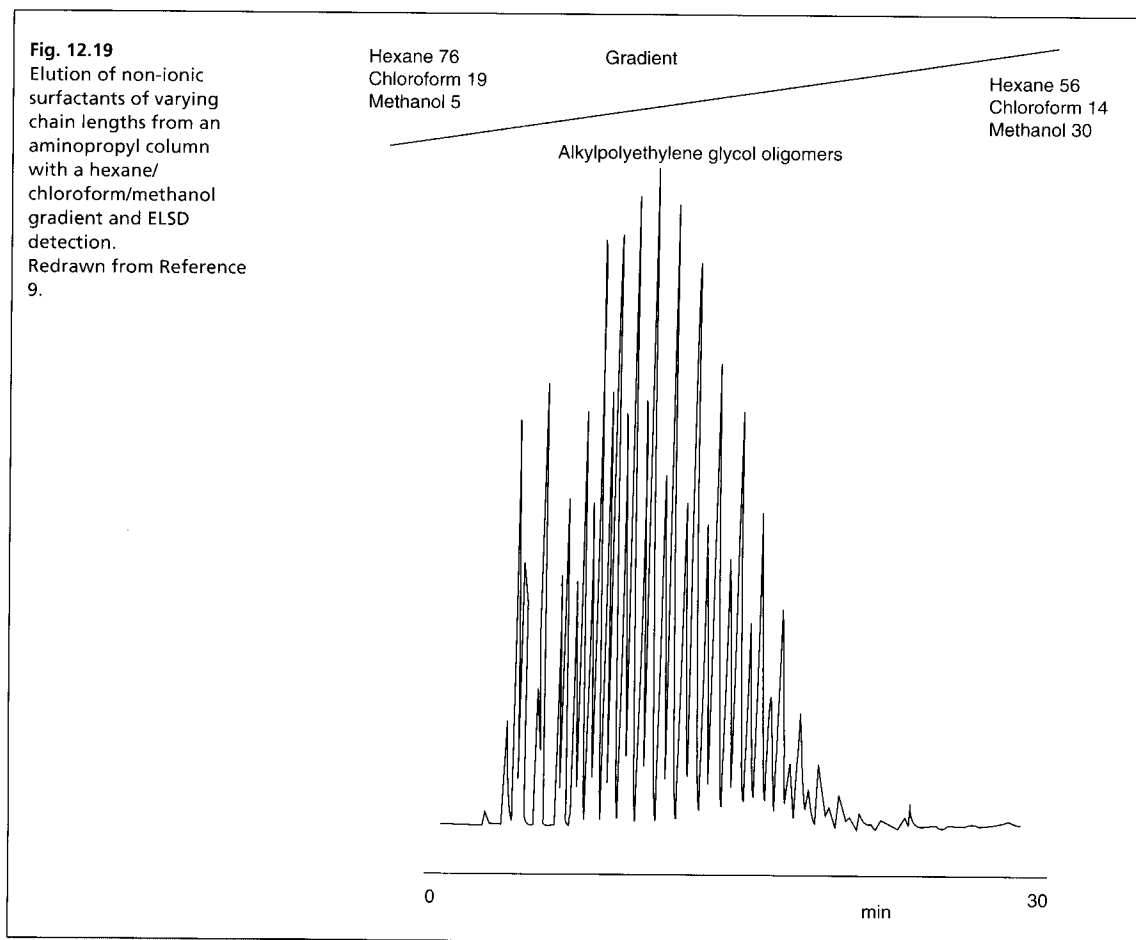

compounds with widely different lipophilicities or polarities. For example mixtures similar to Cetomacrogol 1000 have been separated on a polar aminopropyl column using a gradient between hexane/chloroform/methanol (76:19:5) and hexane/chloroform/methanol (56:14:30) over 30 min with ELSD monitoring of the eluent⁹ as shown in Figure 12.19. The methanol content of the mobile phase is gradually increased with time so that the more polar (longer chain) components elute within a reasonable time.

Assay of catecholamines in urine by ion exchange chromatography with electrochemical detection

The determination of drugs in biological matrices presents a particular analytical challenge. In the example given¹⁰ an electrochemical detector is used because of its high selectivity for catecholamines which oxidise at a relatively low potential thus reducing interference by other less readily oxidised components in the urine. However, even with a selective detector there is still interference by the sample matrix. Figure 12.20A shows a chromatogram obtained using an ODS column with an ion-pairing agent which produces retention of the catecholamines as described earlier for assay of adrenaline in an injection (in the current example the ion-pairing

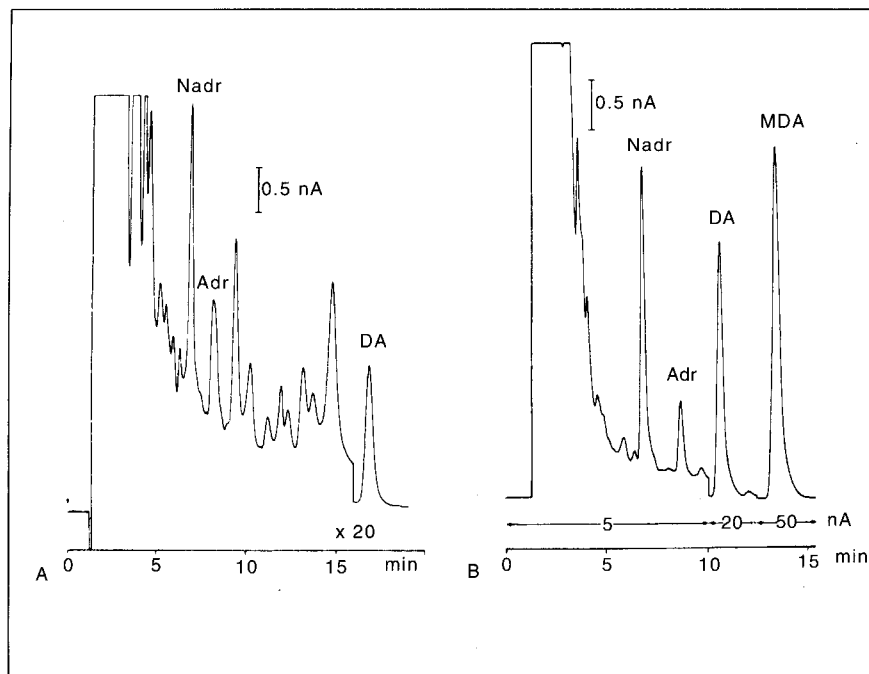

Fig. 12.20
Analysis of adrenaline (adr), noradrenaline (nadr) and dopamine (DA) in urine using: (A) An ODS column with ion-pairing agent in citrate buffer pH 5.0 with 2% tetrahydrofuran (THF) as the mobile phase; (B) a strong cation exchange column with citrate buffer pH 5.0 with 7% THF as the mobile phase. The eluent was monitored by electrochemical detection at a potential of 0.7 V. Methyldopamine (MDA) was used as an internal standard and added to the urine before extraction. Reproduced with permission from *J. Chromatogr. Biomed. Apps.* (see Reference 10).

agent is dimethylcyclohexyl sulphate). Figure 12.20B shows that selectivity for the catecholamines is increased when an ion exchange column is used in conjunction with electrochemical detection.

Derivatisation in HPLC analysis

Derivatisation in pharmaceutical analysis is most often used to improve the selectivity of bioanalytical methods. However, in some cases it is necessary to detect compounds which lack a chromophore. The analysis of aminoglycoside antibiotics is difficult because of complete absence of a chromophore and in addition the antibiotics are usually mixtures of several components. The BP assay of neomycin eyedrops carries out an identity check on the neomycin B and neomycin C components in the eyedrops by derivatising them so that they are detectable by UV monitoring (Fig. 12.21). The polarity of the highly polar amino sugars is reduced in some degree by the derivatisation so that they can be run on a silica gel column in a mobile phase composed of chloroform and ethanol. The advantage of using silica in this case is that the excess non-polar fluorodinitrobenzene derivatising agent will elute from the column well before the polar derivatised glycosides. Derivatisation reactions have also been extensively used in the analysis of amino acids. The literature on derivatisation for HPLC is extensive but generally the use of a suitable detector would be preferred instead of resorting to derivative formation. In recent years pulsed amperometric detection has been increasingly applied to the analysis of aminoglycosides.

Separation of enantiomers by chiral HPLC

Although about 40% of drugs are chiral compounds, only about 12% of drugs are administered as pure single enantiomers. This situation is gradually changing as a number of companies have now started to move towards producing enantiomerically

Fig. 12.21
Analysis of neomycin
with derivative formation
prior to chromatography.

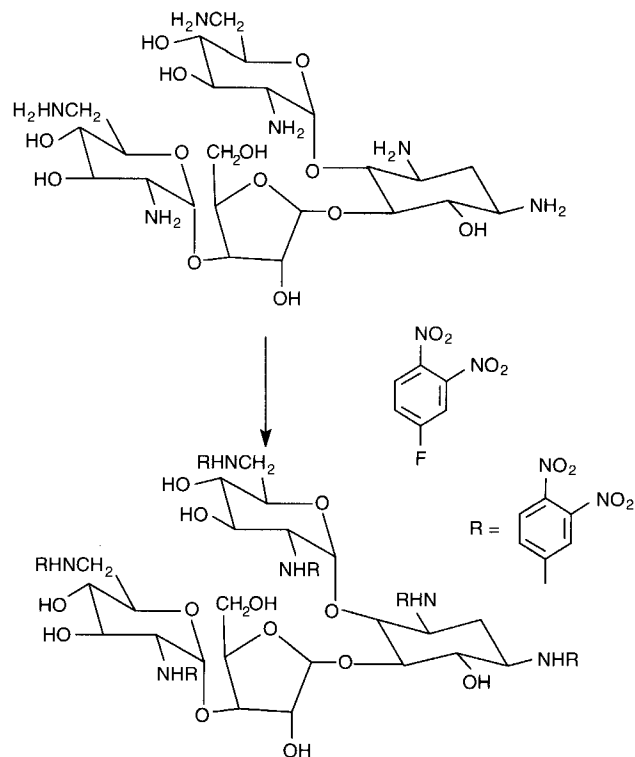

pure forms of established drugs. Thus chromatographic separation of enantiomers is important from the point of view of quality control of enantiomerically pure drugs and also in bioanalytical studies where the pharmacokinetics of two enantiomers may be monitored separately.

The basis of separation in chiral HPLC is the formation of temporary diastereomeric complexes within the chiral stationary phase. This causes enantiomers, which normally exhibit identical partitioning into a non-chiral stationary phase, to partition to a different extent into the stationary phase. In order for separation to occur, the enantiomers must have three points of contact with the stationary phase. This is shown in Figure 12.22, where enantiomer 1 interacts with groups A, B and C. Its mirror image, enantiomer 2, is unable to interact in the same way with more than two of the groups on the chiral stationary phase no matter how it is positioned.

There are numerous chiral stationary phases available commercially, which is a reflection of how difficult chiral separations can be and there is no universal phase which will separate all types of enantiomeric pair. Perhaps the most versatile phases are the Pirkle phases, which are based on an amino acid linked to aminopropyl silica gel via its carboxyl group and via its amino group to (α -naphthyl)ethylamine; in the process of the condensation a substituted urea is generated. There is a range of these type of phases. As can be seen in Figure 12.23, the interactions with phase are complex but are essentially related to the three points of contact model. Figure 12.24 shows the separation of the two pairs of enantiomers (RR, SS, and RS, S,R) present in labetalol (see Ch. 2 p. 36) on Chirex 3020.

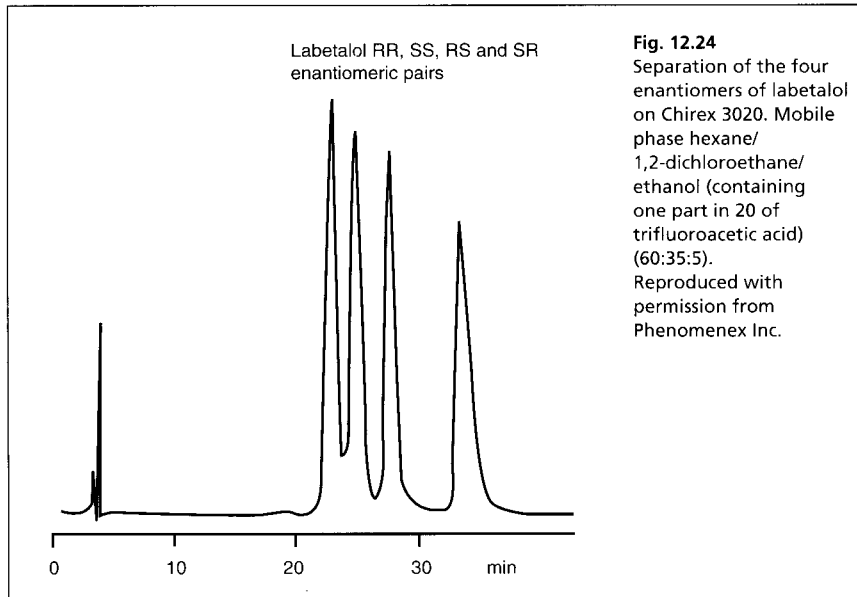
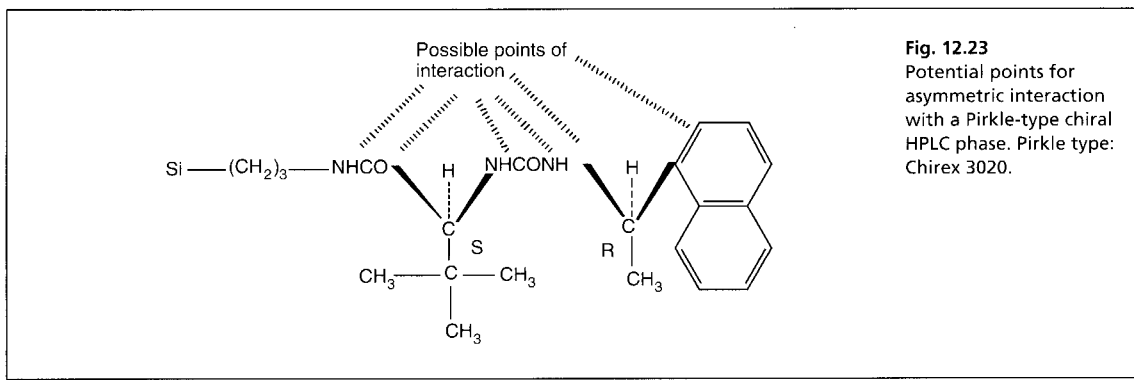
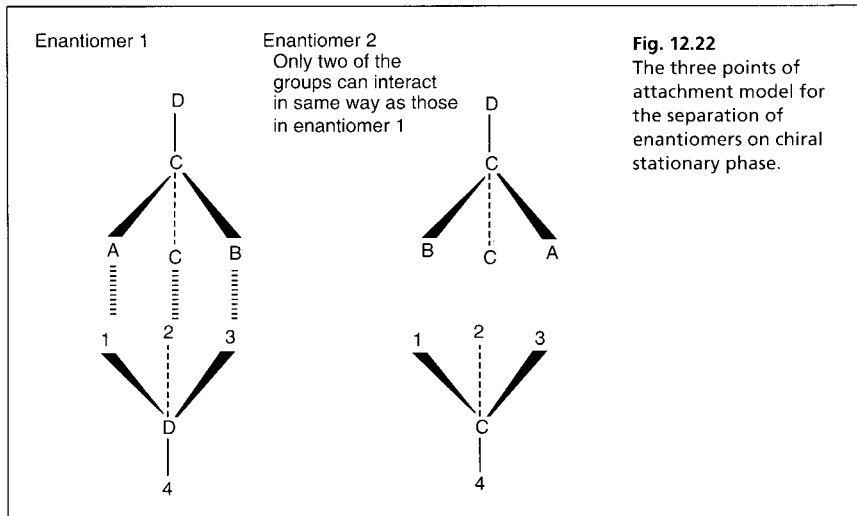

Another popular chiral HPLC phase is based on cyclodextrins anchored onto the surface of silica gel. Cyclodextrins consist of 6, 7 or 8 glucose units linked together into a ring. They adopt a barrel-like shape and the hydrophobic portion of an analyte fits into the cavity. For good separation, the chiral centre in the molecule must be level with the chiral 2 and 3 positions of the glucose units, which are arranged around the barrel rim, and which carry hydroxyl groups that can interact with the groups attached to the chiral centre through three-point contact. Figure 12.25 shows the β -blocker propranolol included within the cyclodextrin cavity.

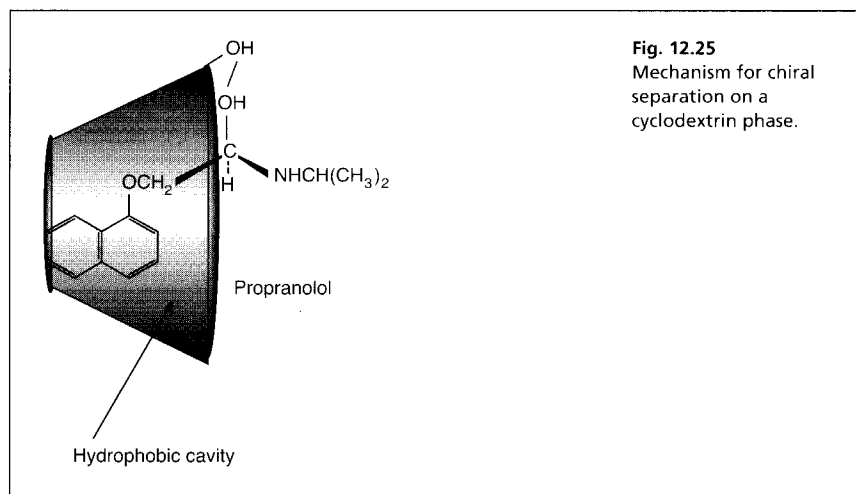

Other chiral phases include those based on proteins, cellulose triacetate, amino acids complexed with copper and chiral crown ethers.

Two other strategies for producing separations of enantiomers involve the addition of chiral modifiers to the mobile phase (e.g. chiral ion-pairing reagents), which can bring about separation on for instance an ordinary ODS column and the formation of derivatives with chirally pure reagents that produce different diastereoisomers when reacted with opposite enantiomers of a particular compound (see GC example, Ch. 11 p. 219).

References

1. V.R. Meyer. Practical high performance liquid chromatography. J. Wiley and Sons, Chichester (1994).
2. K. Robards, P.R. Haddad and P.E. Jackson. Principles and practice of modern chromatography. London Academic Press Inc. (1994).
3. G. Lunn and N. Schmuff. HPLC methods for pharmaceutical analysis. Wiley Interscience, Chichester (1997).
4. C.M. Riley, W.J. Lough and I.W. Wainer. Pharmaceutical and biomedical applications of liquid chromatography. Elsevier, Amsterdam (1994).
5. L.R. Snyder and J.J. Kirkland. Practical HPLC method development. Wiley Interscience, Chichester (1997).
6. J. Barbosa and V. Sanznebot. Anal. Chem. Acta. 283, 320–325 (1993).
7. A. Kaibara, M. Hirose and T. Nakagawa. Chromatographia. 30, 99–104 (1990).
8. R.D. Ricker, L.A. Sandoval, B.J. Permar and B.E. Boyes. J. Pharm. Biomed. Anal. 14, 93–105 (1995).
9. N. Martin. J. Liquid Chromatogr. 18, 1173–1194 (1995).
10. B-M. Eriksson, S. Gusafsson and B.A. Persson. J. Chromatogr. Biomed. Apps. 278, 255–263 (1983).

Additional problems

1. Some non-steroidal anti-inflammatory drugs (NSAIDs) were found to have the following capacity factors in a particular mobile on a reverse-phase column: aspirin 0.4, naproxen 3.6, ibuprofen 14.5, diclofenac 10.4, paracetamol 0.2. Given that the column had a t_r of 2 min determine the retention times of the NSAIDs.

Answers: aspirin 2.8 min; naproxen 9.2 min; ibuprofen 31 min; diclofenac 22.8 min; paracetamol 2.4 min.

2. Predict the order of elution from first to last of the following steroids from an ODS column in methanol/water (60:40) as a mobile phase (Fig. 12.26).

Fig. 12.26

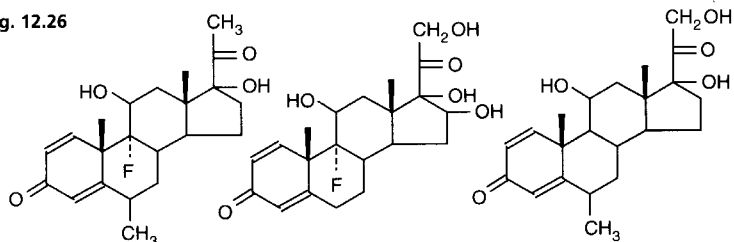

Fluorometholone

Triamcinolone

Methylprednisolone

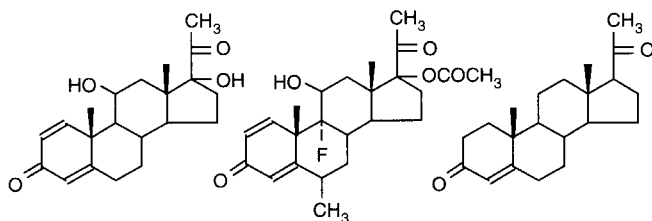

Prednisolone

Fluorometholone acetate

Progesterone

Answers: triamcinolone, methylprednisolone, prednisolone, fluorometholone, fluorometholone acetate, progesterone.

3. Predict the order of elution from first to last of the following morphinane compounds from an ODS column in an acetonitrile/buffer mixture pH 8.0 (10:90). Assume the pK_a values of the bases are all similar (Fig. 12.27)

Fig. 12.27
Morphinane compounds eluted from an ODA column.

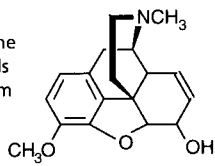

Codeine

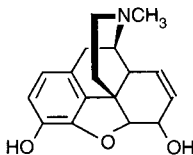

Morphine

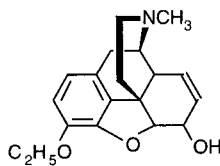

Ethylmorphine

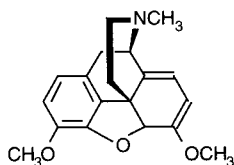

Thebaine

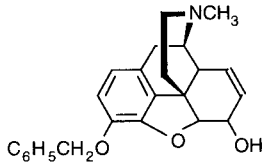

Benzylmorphine

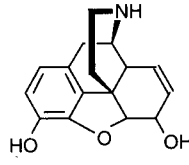

Normorphine

Answer: normorphine, morphine, codeine, ethylmorphine, thebaine, benzylmorphine

4. An analysis is carried out on codeine linctus stated to contain 0.3% w/v of codeine phosphate. The mobile phase consists of 0.1 M acetic acid/methanol (40:60), contains 0.01 M octane sulphonic and chromatography is carried out on a reverse-phase column with UV monitoring at 285 nm. A one-point calibration was carried out against a calibration standard containing ca 0.06% w/v codeine phosphate. The following data were obtained:

- Weight of linctus analysed = 12.7063 g
- Density of linctus = 1.25 g/ml
- The linctus is diluted to 50 ml with water prior to analysis
- Area of codeine peak obtained by analysis of the linctus = 86 983
- Area of codeine phosphate calibration peak = 84 732
- Percentage of w/v of codeine phosphate in calibration standard = 0.06047.

Why is the octane sulphonic acid included in the mobile phase?

Calculate the percentage of w/v of codeine phosphate in the linctus.

Answer: 0.3053% w/v

5. Analysis is carried out on tablets containing naproxen 100 mg and aspirin 250 mg per tablet. A narrow range calibration curve is constructed within $\pm 20\%$ of the expected concentration of the diluted tablet extract. UV monitoring of the column effluent is carried out at 278 nm. Suggest a column and mobile phase for this analysis; both aspirin and naproxen are discussed earlier in this chapter. Suggest a suitable column and mobile phase for this analysis. The following data were obtained for the analysis:

- Weight of 20 tablets = 10.3621 g
- Weight of tablet powder assayed = 257.1 mg
- Volume of initial extract = 250 ml.

Dilution steps:

- 10 to 100 ml
- 20 to 100 ml
- Calibration curve for naproxen $y = 174\ 040 x + 579$ $r = 0.999$
- Calibration curve for aspirin $y = 54\ 285 x + 1426$ $r = 0.999$

where x is in mg/100 ml

- Area of peak obtained for naproxen in diluted sample extract = 72 242
- Area of peak obtained for aspirin in diluted sample extract = 54 819.

Calculate the percentage of stated content for naproxen and aspirin.

Answers: naproxen 103.7%; aspirin 99.1%

6. Analysis is carried out on a cream stated to contain 2% w/w of both miconazole and hydrocortisone. An ODS column is used with a mobile phase consisting of acetonitrile/acetate buffer pH 4.0 (70:30) and the eluent is monitored at 220 nm. A narrow range calibration curve, within $\pm 20\%$ of the expected concentration of each analyte in the sample extract was prepared for each analyte by plotting the ratio of the areas of the analyte peaks against fixed amounts of the internal standards for both analytes. The internal standards used were: econazole and hydrocortisone 21-acetate for miconazole and hydrocortisone, respectively.

How would the retention time of hydrocortisone compare in the mobile phase used in this assay with a mobile phase containing methanol/acetate buffer pH 4.0 (70:30) and why do you think hydrocortisone 21-acetate is used as an internal standard rather than the betamethasone used in the assay discussed earlier in this chapter?

Suggest a suitable extraction procedure for extracting the analytes from the cream and for removing oily excipients and indicate any other preparation which might be required prior to analysis.

The following data were obtained:

- Weight of cream taken for assay = 1.0223 g
- Final volume of extract from cream = 100 ml

- Equation of line for miconazole $y = 0.044x - 0.013$ $r = 0.999$
- Equation of line for hydrocortisone $y = 0.048x - 0.024$ $r = 0.999$

where x is in mg/100 ml.

- Area of hydrocortisone peak in sample extract = 62 114
- Area of hydrocortisone acetate peak in sample extract = 64 452
- Area of miconazole peak in sample extract = 35 557
- Area of econazole peak in sample extract = 38 385

Calculate the percentage of w/v of miconazole and hydrocortisone in the cream.

Answers: hydrocortisone 2.013% w/w; miconazole 2.088% w/w

13

Thin layer chromatography

Keypoints	Treatment of silica gel with KOH	Location reagents
Introduction	Silanised silica gel	Applications of TLC analysis
Instrumentation	Keiselguhr as an inert support	Qualitative identity tests
TLC chromatogram		Limit tests
Stationary phases	Detection of compounds on TLC plates following development	HPTLC
Elutropic series and mobile phases	Ultraviolet light	Applications of HPTLC
Modification of TLC adsorbant		

KEYPOINTS**Principles**

- An analyte migrates up or across a layer of stationary phase (most commonly silica gel), under the influence of a mobile phase (usually a mixture of organic solvents), which moves through the stationary phase by capillary action. The distance moved by the analyte is determined by its relative affinity for the stationary vs the mobile phase.

Applications

- Used to determine impurities in pharmaceutical raw materials and formulated products
- Often used as a basic identity check on pharmaceutical raw materials.
- Potentially useful in cleaning validation, which is part of the manufacture of pharmaceuticals.

Strengths

- Detection by chemical reaction with a visualisation reagent can be carried out, which means that more or less every type of compound can be detected if a suitable detection reagent is used.
- Robust and cheap.
- In conjunction with densitometric detection, it can be used as a quantitative technique for compounds which are difficult to analyse by other chromatographic methods because of the absence of a chromophore.
- Since all the components in the chromatographic system can be seen, there is no risk, as is the case in gas chromatography (GC) and HPLC analyses, that some components are not observed because they do not elute from the chromatographic system.
- Batch chromatography can be used to analyse many samples at once, increasing the speed of analysis, and can be automated.

- The method is flexible since thin layer chromatography (TLC) plates can be simply treated with a variety of chemicals thus imparting a wide range of properties to the stationary phase.

Limitations

- The number of theoretical plates available for separation is limited in routine TLC systems, although high performance TLC (HPTLC) plates can offer nearly the same efficiency in a 10 cm distance as an HPLC column of the same length
- Sensitivity is often limited
- Not suitable for volatile compounds
- Requires more operator skill for optimal use than HPLC.

Introduction

Thin layer chromatography (TLC) has developed into a very sophisticated technique for identification of compounds and for determination of the presence of trace impurities. Since it was one of the earliest chromatographic techniques, a huge array of TLC-based tests is available and pharmacopoeial monographs reflect the extent to which this technique has been developed as a fundamental quality control technique for trace impurities. The reason for its prominence in this regard is due to its flexibility in being able to detect almost any compound, even some inorganic compounds. Following TLC, the entire chromatogram can be seen and thus there is no doubt over whether or not components in a sample have failed to elute from a chromatographic system as is the case with HPLC and GC, and even capillary electrophoresis (CE). In this short chapter it would be impossible to outline all of the tests that can be used; comprehensive reviews of the technique have been written.^{1,2} Even the most advanced form of TLC, high performance TLC (HPTLC), remains essentially a simple technique. The sophistication in the application of the technique derives from the broad choice of stationary phases, mobile phases and the wide range spray reagents which can be used for visualising the chromatogram.

Instrumentation

Figure 13.1 shows a simple thin layer chromatography apparatus.

The most frequently used system is a glass or plastic plate coated with silica gel; for routine applications the silica gel particle size is in the range 2–25 μm . The method of use for this system is as follows:

- (i) A few μl of sample solution are slowly spotted onto the plate at the origin. If more than *ca* 1 μl is applied at once, the spot will spread too far. The spot has to be allowed to dry between each application of 1 μl . Loadings of sample are typically 20 μg .
- (ii) The bottom 0.5 cm of the plate is immersed in the mobile phase contained in a tank and the liquid mobile phase is allowed to travel up the silica gel plate by capillary action.
- (iii) The more polar a compound is the more it adsorbs (partitions into) the silica gel stationary phase, the less time it spends in the mobile phase as it travels up the plate and thus the shorter the distance it travels up the plate in a given time.

TLC chromatogram

A diagram of a typical thin-layer chromatography plate after development and spraying to locate the analytes is shown in Figure 13.2.

Fig. 13.1
Basic apparatus for thin-layer chromatography.

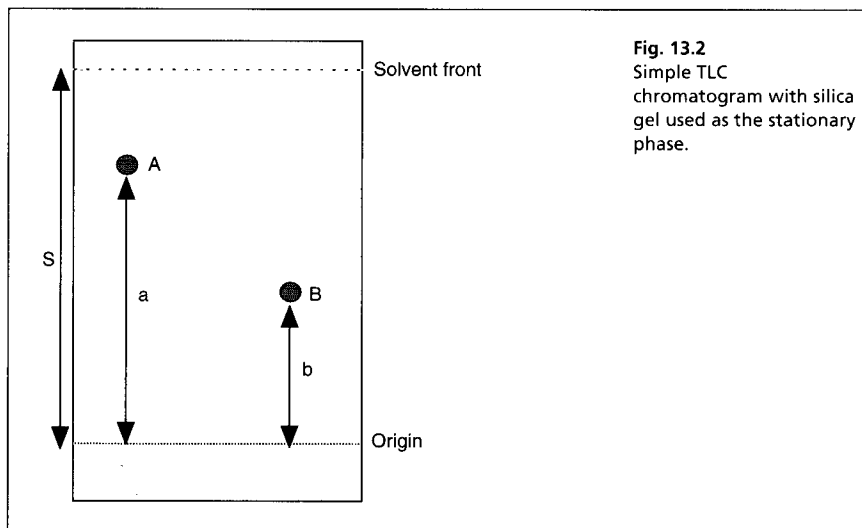
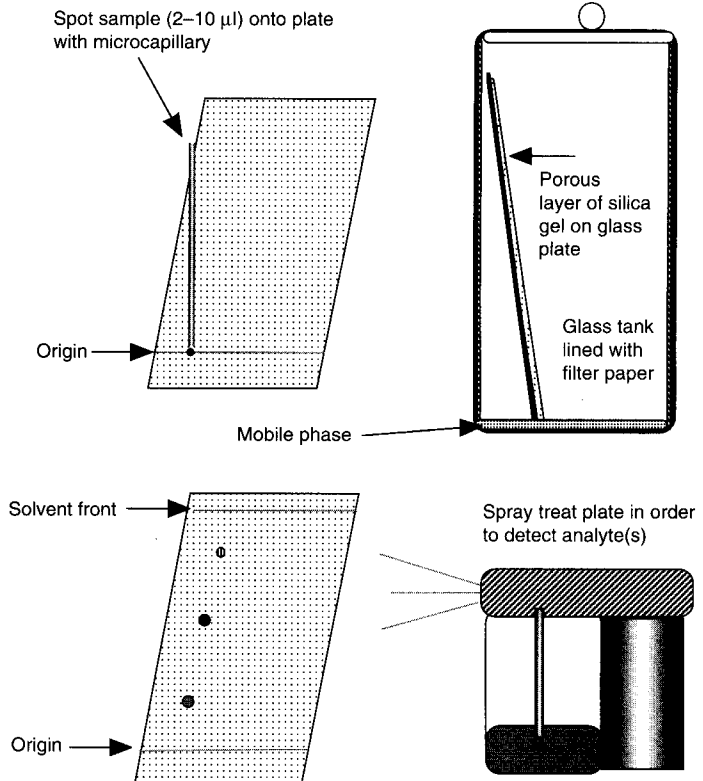

Fig. 13.2
Simple TLC chromatogram with silica gel used as the stationary phase.

In Figure 13.2, compound A is less polar than compound B since it travels further with the mobile phase in the same time. The distance travelled by the compound from the origin (where the compound is put onto the plate) divided by the distance travelled by the solvent from the origin is called the 'R_f value' of the compound. For example, for compound A, $R_f = a/S$; for compound B, $R_f = b/S$; the R_f is usually quoted as a $R_f \times 100$ value. The area/intensity of a spot on a TLC plate is logarithmically related to the concentration of the analyte producing it.

Self-test 13.1

Solvent is allowed to move 10 cm from the origin up a TLC plate. The time taken to develop the plate for this distance is 15 min. On the basis of this information, complete the table below.

Distance moved by analyte	R _f × 100 value	Time spent in mobile phase	Time spent in stationary phase
(i) 8 cm			
(ii) 6 cm			
(iii) 4 cm			

Answers: (i) 80, 12, 3; (ii) 60, 9, 6; (iii) 40, 6, 9

Stationary phases

Silica gel (Fig. 13.3) is the most commonly used adsorbant for TLC. The rate at which compounds migrate up a silica gel plate depends on their polarity. In a given length of time, the most polar compounds move the least distance up the plate while the least polar move the furthest.

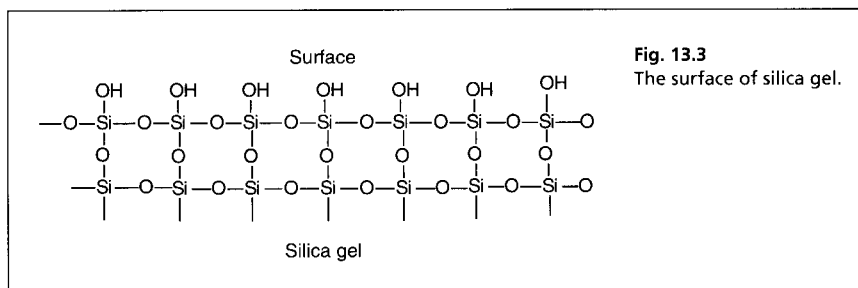

Although silica gel is used widely, some other polar stationary phases are also used in pharmacopoeial tests; silica gel may also be used in modified form. Some examples of stationary phases are given in Table 13.1.

Elutropic series and mobile phases

As described in Chapter 12, the strength of a mobile phase depends on the particular solvent mixture used. Table 13.2 lists common solvents in order of increasing polarity. The more polar a solvent or solvent mixture, the further it will move a polar compound up a silica gel TLC plate. When non-polar compounds are being analysed, there will not be a marked increase in the distance migrated with increasing polarity of the mobile phase since they migrate towards the solvent front under most conditions. Although water is polar, there are practical difficulties in using pure water as a solvent since many organic compounds are not very soluble in water; thus

Table 13.1 Stationary phases which are commonly used in TLC

Stationary phase	Description	Applications
Silica gel G	Silica gel with average particle size $15\ \mu\text{m}$ containing ca 13% calcium sulphate binding agent	Use in a wide range of pharmacopoeial tests. In practice commercial plates may be used which contain a different type of binder
Silica gel GF ₂₅₄	Silica gel G with fluorescent agent added	The same types of applications as silica G where visualisation is to be carried out under UV light
Cellulose	Cellulose powder of less than $30\ \mu\text{m}$ particle size	Identification of tetracyclines
Keiselguhr G	Diatomaceous earth containing calcium sulphate binder	Used as a solid support for stationary phases such as liquid paraffin used in analysis of fixed oils

Self-test 13.2

The steroids below are spotted onto a silica gel TLC plate. The plate is developed in methylene chloride/ether/methanol/water (77:15: 8:1.2) and under UV light has the appearance shown in Figure 13.4. From your knowledge of the polarity of organic molecules, match the steroids to the spots on the TLC plate shown in Figure 13.4.

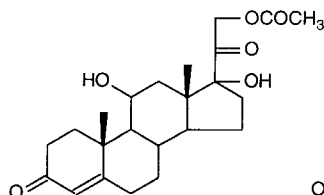

Hydrocortisone acetate

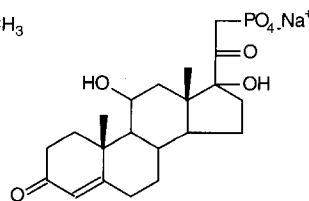

Hydrocortisone sodium phosphate

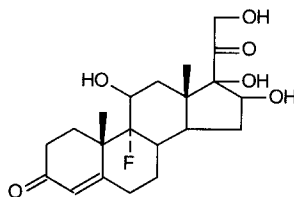

Triamcinolone

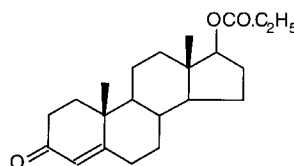

Testosterone propionate

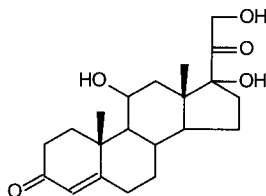

Hydrocortisone

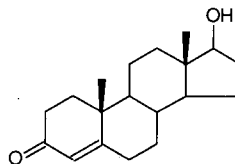

Testosterone

Answer: 1. hydrocortisone sodium phosphate; 2. triamcinolone; 3. hydrocortisone; 4. hydrocortisone acetate; 5. testosterone; 6. testosterone propionate

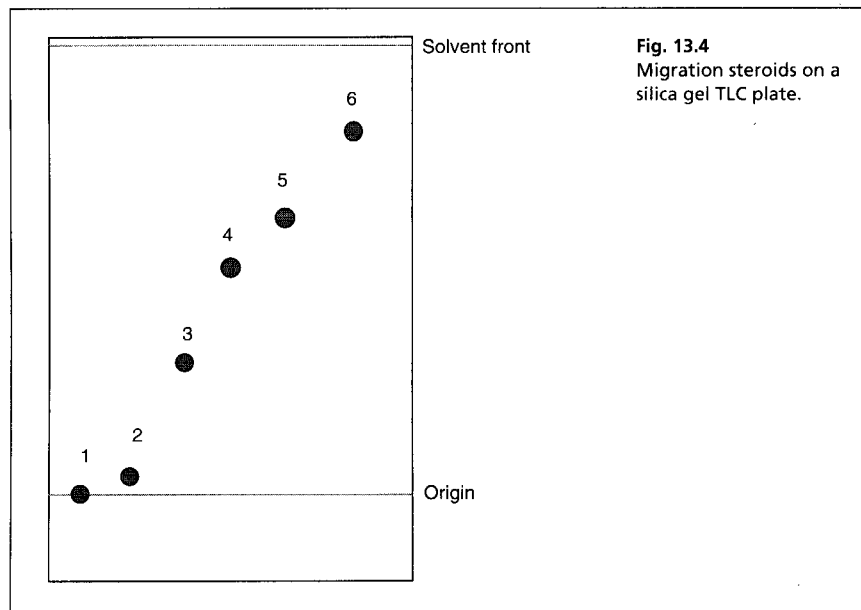

Fig. 13.4
Migration steroids on a
silica gel TLC plate.

Table 13.2 Elutropic series

Solvent	Polarity index
Hexane (C ₆ H ₁₄)	0
Toluene (C ₇ H ₈)	2.4
Diethylether (C ₄ H ₁₀ O)	2.8
Dichloromethane (CH ₂ Cl ₂)	3.1
Butanol (C ₄ H ₉ OH)	3.9
Chloroform (CHCl ₃)	4.1
Ethyl acetate (C ₂ H ₅ COOCH ₃)	4.4
Acetone (CH ₃ COCH ₃)	5.1
Methanol (CH ₃ OH)	5.1
Ethanol (C ₂ H ₅ OH)	5.2
Acetonitrile (CH ₃ CN)	5.8
Acetic acid (CH ₃ COOH)	6.2
Water (H ₂ O)	9.0

it is usually used in mobile phases containing a water miscible organic solvent such as methanol. Quite subtle changes in separation can be achieved by using complex mixtures of solvents. Because of its simplicity, TLC is often used as a preliminary screen for identifying drugs and thus mobile phases have been developed which ensure that a particular drug will have a quite different R_f value in one system compared with another.

For example, in a general screen for acidic drugs, which includes most of the NSAIDs (Fig. 13.5), three mobile phases may be used.¹ Table 13.3 shows the R_f values obtained for three NSAIDs in three different mobile phases. It can be seen from the data in Table 13.3 that even for closely related structures slight differences in polarity and lipophilicity can be exploited to produce separation. For instance, ibuprofen is the least polar drug in system 1 but is the most polar drug in system 3, where the carboxyl groups in the structures will be ionised due to the ammonia in the mobile phase. It can also be seen that the polarity of a mobile phase containing a mixture of chloroform and acetone is similar to that of pure ethyl acetate.

Fig. 13.5
Some NSAIDs.

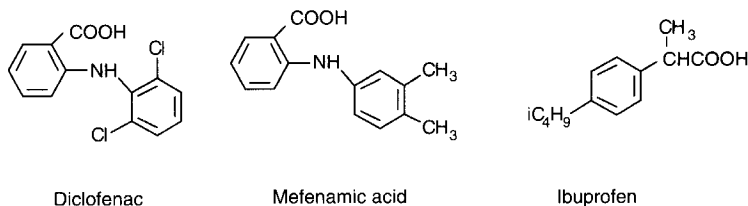
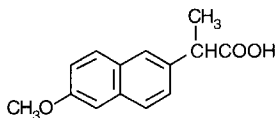

Table 13.3

Mobile phase	diclofenac Rf	mefenamic acid Rf	ibuprofen Rf
1. Chloroform/acetone (4:1)	25	41	46
2. Ethyl acetate	40	54	54
3. Ethyl acetate/methanol/strong ammonia solution (80:10:10)	29	32	18

Self-test 13.3

Considering the three solvent systems (1, 2 and 3) given in Table 13.3, indicate which set of Rf values is most likely to apply to naproxen.



Naproxen

(i) 1. 18, 2. 25, 3. 24; (ii) 1. 40, 2. 25, 3. 14; (iii) 1. 33, 2. 45, 3. 14; (iv) 1. 20, 2. 28, 3. 10

Answer: (iii)

Modification of TLC adsorbant

Treatment of silica gel with KOH

For analysis of basic compounds, silica gel which has been sprayed with a solution of KOH in methanol, may be used. Treating the plate with base ensures that basic compounds chromatograph as their free bases rather than as their salts. The salts of the amines have very low mobility in organic solvent-based mobile phases since basic compounds tend to interact strongly with silanol groups on the surface of the silica; the presence of KOH in the stationary phase suppresses this interaction. The mobile phases used in these type of systems also typically contain a basic component. Examples of the mobile phases used for the analysis of basic drugs on KOH impregnated silica gel include:

- (i) Methanol/strong ammonia solution (100:1.5)
- (ii) Cyclohexane/toluene/diethylamine (75:15:10)
- (iii) Chloroform/methanol (90:10).

System 2 is quite non-polar and useful for discriminating between highly lipophilic bases, which include many of the antihistamines and narcotics, and sympathomimetic bases, which are often quite polar and move very little in mobile phase 2. The use of selective solvent systems is often combined with use of location agents that are selective for nitrogenous drugs.

Silanised silica gel

The surface of the silica gel can be rendered non-polar by reaction with dichlorodimethylsilane as shown in Figure 13.6. A wide range of silanising reagents can be used in this type of reaction including octadecylsilanes, which produce ODS silica gel plates analogous to ODS HPLC columns. The BP uses silanised silica gel TLC plates in identity tests for penicillins. For example, a 0.25% w/v solution of ampicillin test material is applied to a silanised silica gel plate along with an ampicillin reference standard (0.25% w/v), Solution 2, and a mixture containing reference standards for ampicillin and amoxicillin trihydrate (0.25% w/v), Solution 3. The plate is developed with a mobile phase consisting of a solution of ammonium acetate adjusted to pH 5.0 with acetic acid and acetone (90:10). After development, the plate is stained with iodine vapour; the identity test specifies that the test substance should give a single spot with the same Rf as that seen for Solution 2 and that Solution 3 should show two clearly separated spots.

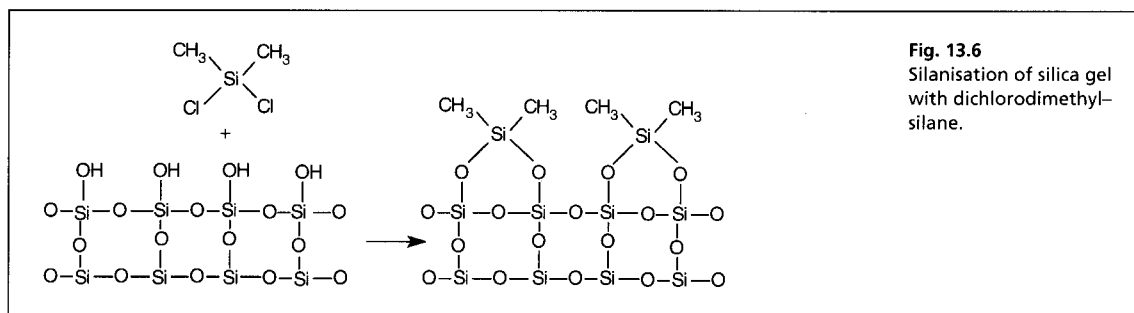

This type of test could be carried out equally well with commercially produced ODS plates. Silica gel plates can be simply modified with reaction with organosilane reagents, the availability of a wide range of reactive organosilanes means that there is potential for producing a wide range of coated TLC plates for specific purposes.

Keiselguhr as an inert support

Keiselguhr in itself does not have strong absorptive properties but it can be coated with a liquid or waxy stationary phase. The keiselguhr coated with liquid paraffin is used in a pharmacopoeial test for triglycerides and fatty acids in fixed oils. The keiselguhr plate is impregnated with a solution containing liquid paraffin in petroleum ether. This renders the surface hydrophobic. The samples of fixed oil being examined are applied to the plate and the plate is developed with acetic acid as the mobile phase. Acetic acid is a very polar solvent and thus the liquid paraffin stationary phase does not dissolve in it appreciably. Furthermore, the triglycerides in the fixed oil are only weakly polar and will partition usefully between the liquid paraffin stationary phase and the acetic acid mobile phase. The longer the chain length of the fatty acids in the triglyceride the lower the Rf of the triglyceride. The plate is visualised by staining with iodine and then permanently staining the iodine spots with starch solution. The BP shows the typical chromatograms that would be obtained from a number of fixed oils which are composed of mixtures of triglycerides in different proportions. The triglyceride composition of a particular fixed oil does not vary greatly and is very characteristic. A similar test to the one described above is carried out for the fatty acids composing the oil following hydrolysis of the triglycerides.

Other agents used to impregnate keiselguhr include: formamide and propan-1,2-diol. In the case of these impregnating agents, the mobile phases used to develop the treated plates have to be of low polarity to avoid washing the agent off the plate.

Detection of compounds on TLC plates following development

A wide range of methods can be used to detect compounds on a TLC plate following its development with a mobile phase.

Ultraviolet light

In order to observe the absorption of UV light by an analyte, silica gel which has been impregnated with a fluorescent material is used to prepare the TLC plate. Light with a wavelength of 254 nm is used to illuminate the plate and if the analyte absorbs UV light it can be seen as a black spot on a yellow background where it quenches the fluorescence of the background. This method of visualisation is used in many pharmacopoeial tests since most drugs possess chromophores. If a compound is naturally fluorescent, longer wavelength light at 365 nm may be used to visualise the plate. For example, the pharmacopoeial test for anthraquinones in aloes observes the fluorescence of these compounds under UV light at 365 nm.

Location reagents

There is a huge number of location reagents available and these reagents range from those which are fairly specific for a particular type of analyte to those which will detect many different compounds.

Iodine vapour

The plate is put into a tank containing iodine crystals. This treatment will produce brown spots with many organic compounds; the staining is reversible, so that if it is necessary to recover the compound once it has been located, the iodine may be allowed to evaporate by exposing the plate to air and then the marked spot containing the compound of interest may be scraped off the plate. If a permanent record of the plate is required it has to be covered to prevent the iodine evaporating or the iodine spots may be sprayed with starch solution in order to stain them permanently. Iodine is used as a location agent in pharmacopoeial TLC tests of fixed oils and of cetrimide.

Potassium permanganate

Potassium permanganate provides a method for the detection of sugars and sugar-like molecules, and drugs with aliphatic double bonds. It is used in TLC identity checks for the antibacterial agents clindamycin and lincomycin and in a check for related substances in spectinomycin.

Ninhydrin solution

This reagent gives pink spots with primary amines and yellow spots with tertiary amines. It is used in pharmacopoeial identity tests for some of the aminoglycoside antibiotics such as gentamycin, in a limit test for aminobutanol in ethambutol and can be used as a general screen for nitrogen-containing drugs in conjunction with Dragendorff reagent. Dragendorff reagent will produce orange spots with tertiary

amines and may be used to overspray plates which have been sprayed in the first instance with ninhydrin.

Alkaline tetrazolium blue

This reagent is quite specific for corticosteroids producing blue spots on a white background. The tetrazolium spray is used in a test for related foreign steroids in fluclorolone acetoneide.

Ethanol/sulphuric acid 20%

This reagent is used to produce fluorescent spots from corticosteroids such as dexamethasone or prednisolone by spraying the plate, heating to 120°C and then observing the plate under UV light at 365 nm.

Applications of TLC analysis

Qualitative identity tests

TLC is often used by BP monographs as part of a number of identity tests performed on pure substances. For extra confirmation of identity, more than one solvent system may be used and also different types of spray reagent may be used. Some examples of identity checks based on TLC have been mentioned earlier. Table 13.4 lists a few of the compounds which have their identity checked by TLC and a variety of location reagents and mobile phases are used to illustrate the fact that there is much less uniformity about TLC methodology than there is in the case of HPLC or GLC methodology.

Table 13.4 Some examples of identity tests based on TLC described in pharmacopoeial monographs

Substance examined	Stationary phase	Mobile phase	Visualisation reagent	Comments
Framycetin sulphate	Silica gel + carbomer binder	10% w/v KH_2PO_4	Naphthalene diol/ H_2SO_4	R _f and colour of the sample are compared with a pure standard. The resolution of the analyte from streptomycin is checked
Methyl prednisolone	Silica gel GF ₂₅₄	Ether/toluene/butan-1-ol saturated with water (85:10:5)	UV light 254 nm then ethanolic sulphuric acid (20%) + heat to 120°C	R _f and colours of the sample and standard are compared. Also R _f of an oxidation product is used as an additional check
Aprotinin	Silica gel	Acetate buffer	Ninhydrin spray	R _f and colour of the analyte spot is compared with standard
Levamisole	Silica gel H with fluorescent indicator	Toluene/acetone/13.5 M ammonia (60:40:1)	UV light 254 nm	R _f and size of the spot obtained is matched to that of a standard.
Pentagastrin	Silica gel G	Analyte is examined by TLC in three different mobile phases	4-dimethyl-aminobenzaldehyde in methanol/HCl	The R _f of the analyte in three different mobile phases is determined and the colour of its spot is matched to that of the standard

Limit tests

Where the structure of the impurity is known

TLC is used to perform limit tests for impurities in many pharmacopoeial monographs. A TLC limit test is based on comparison between a concentrated solution of an analyte and a dilute solution of an impurity. The intensities of the spots due to any impurities in the analyte are compared with the intensity of a spot or spots due to standards spotted separately onto the same plate. For the purposes of the examples illustrated as follows, intensity and size are regarded as being interchangeable, which they are to a large extent. For instance a limit test might be conducted for hydrocortisone in hydrocortisone acetate as follows: 5 μl of 1% w/v solution of hydrocortisone acetate are spotted onto the origin of a TLC plate; at another position on the plate, 5 μl of a 0.01% w/v of hydrocortisone are spotted on. The TLC plate is developed in the solvent described in Self-test 13.1 and might appear as shown in Figure 13.7 when viewed under UV light. In the example shown, a small amount of hydrocortisone impurity can be seen running below the large spot due to hydrocortisone acetate, which is the main component in the sample. In line with the position where the hydrocortisone standard was spotted onto the plate, there is a very faint spot. In this case the spot for the hydrocortisone impurity in the sample can be seen to be more intense (larger) than the spot due to the 0.01% w/v hydrocortisone standard and thus the sample has failed the limit test. This test is a 1% limit test since $0.01/1 \times 100 = 1\%$.

Fig. 13.7
TLC limit test for hydrocortisone in hydrocortisone acetate.

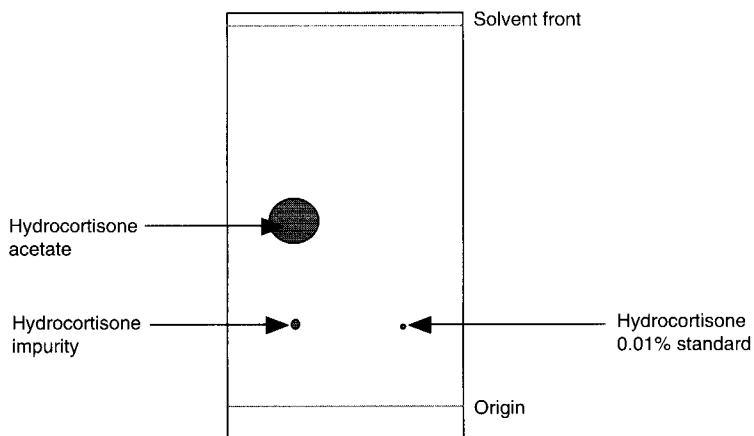

Self-test 13.4

A limit test is conducted for hydrocortisone in hydrocortisone sodium phosphate. 2 μl of a 1% w/v solution of hydrocortisone sodium phosphate is compared with 2 μl of a solution containing 0.02% w/v hydrocortisone standard using the solvent system given in Self-test 13.1.

- What is the percentage limit for hydrocortisone in hydrocortisone sodium phosphate set by this test?
- Would the spot for the impurity appear above or below the substance being examined? (see Self-test 13.1).

Answers: (i) 2%; (ii) Above

Table 13.5 shows some BP limit tests for known impurities used in pharmacopoeial monographs.

Table 13.5 BP limit tests for known impurities in pharmaceutical raw materials

Test substance	Impurity	Limit set (%)
Clotrimazole	Chlorotritanol	0.2
Clotrimazole	Imidazole	0.2
Cyclizine	N-methylpiperazine	0.5
Dexpanthenol	3-aminopropanol	0.5
Ethinylestradiol	Estrone	1.0
Loprazolam mesylate	N-methylpiperazine	0.25
Mefenamic acid	2,3-dimethyl aniline	0.01
Mexiletine hydrochloride	2,6-dimethyl phenol	0.2
Phenoxyethylpenicillin	Phenylacetic acid	0.5

As in the case of hydrocortisone acetate, where hydrocortisone might be expected to occur as a result of hydrolysis of the acetate ester, tests for the presence of known impurities are based on the known manufacturing sequence or on likely degradation pathways. For example, the tests carried out on clotrimazole are based on the last step in its manufacture as shown in Figure 13.8. Unreacted imidazole is an obvious impurity and chlorotritanol would be readily formed from unreacted chlorotriyl bromide by hydrolysis, which would occur when the clotrimazole is extracted from the reaction mixture.

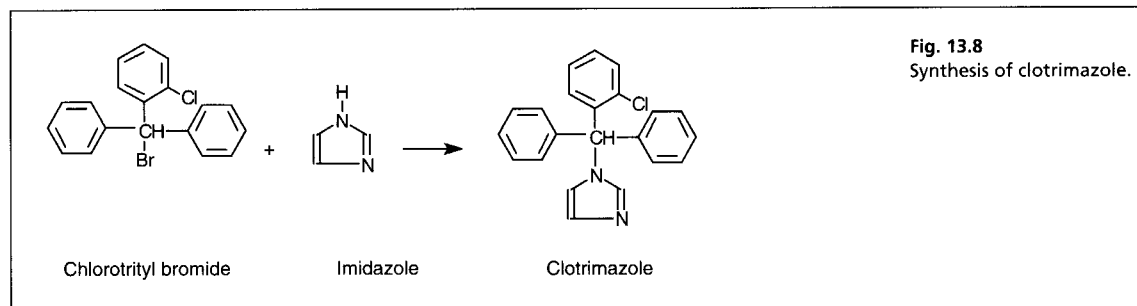

Fig. 13.8
Synthesis of clotrimazole.

Most of the examples given in Table 13.5 have similar obvious origins in the drug manufacturing process.

Where the structure of the impurity is unknown

A related type of TLC limit test is carried out where the identities of impurities are not completely certain. This type of test is used, for instance, on compounds of natural origin or partly natural origin which may contain a range of compounds related in structure to the test substance which are co-extracted with the raw starting material. For example, the range of synthetic steroids originate from triterpenoids extracted from plants, which are extensively modified by fermentation and chemical synthesis.

The assumption which is made in the type of test described following is that the related unknown substances will produce a similar intensity of spot to the test substance itself at equal concentrations. For example, a limit test is conducted for related (foreign) alkaloids in codeine, which is extracted from the opium poppy in which a range of alkaloids occur: thus, the exact identity of the impurities may not be known. To conduct the test, 10 μ l amounts of three solutions are applied separately to a TLC plate. The solutions contain: 4.0% w/v codeine (Solution 1),

0.06% w/v codeine (Solution 2) and 0.04% w/v codeine (Solution 3). In the test, the dilute solutions of codeine are used as visual comparators for any impurities in the sample. The plate is developed in ethanol/cyclohexane/13.5 M ammonia (72:30:6), is dried and is then sprayed with iodobismuthate reagent, which is specific for nitrogenous drugs. After development and spraying the plate might look like the diagram shown in Figure 13.9. The conditions set by the limit test are that:

- (i) There should be no secondary spot in the chromatogram of Solution 1 which is more intense than the spot obtained with Solution 2.
- (ii) There should be no more than one secondary spot, with a R_f value higher than that of codeine, which is more intense than the spot obtained with Solution 3.

In this test, two limits are being set: $0.06/4 \times 100 = 1.5\%$ and $0.04/4 \times 100 = 1.0\%$.

This type of test can be a little confusing at first since there are a number of permutations that can lead to the sample passing or failing of the test.

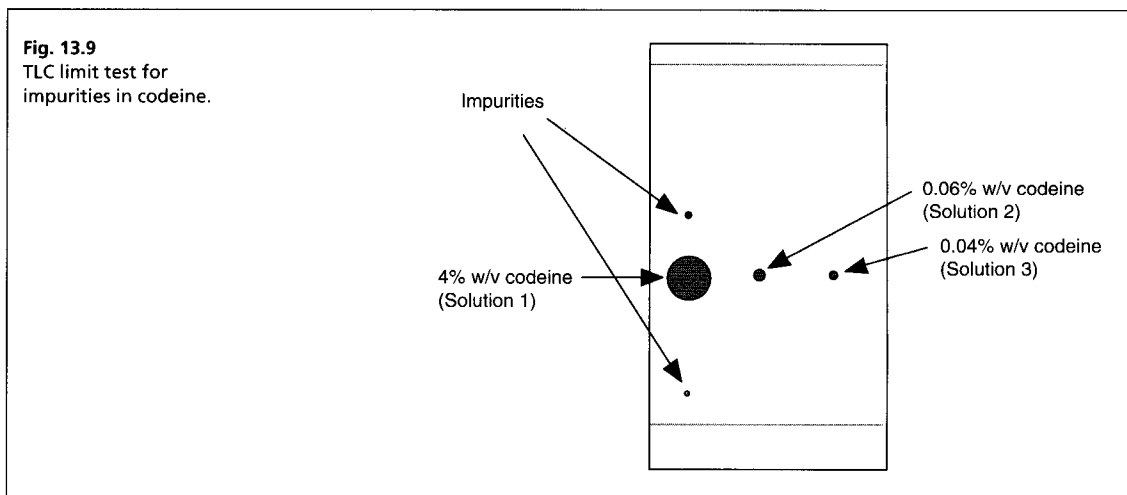

Self-test 13.5

Three samples of codeine are analysed as described earlier, which indicate whether the TLC limit tests shown below pass or fail the samples. Solutions 1–3 appear in numerical order from left to right.

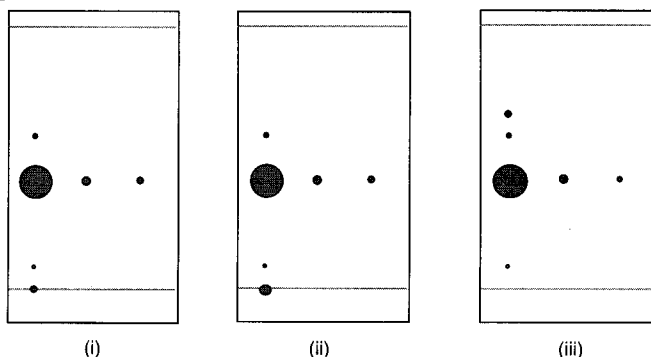

- (i) Passes since there is no spot in the chromatogram of Solution 1 more intense than the spot due to Solution 2.
- (ii) Fails since the spot at origin is more intense than the spot due to Solution 2.
- (iii) Passes since, although one spot above codeine is more intense than the spot due to Solution 3, there is still no spot more intense than the spot due to Solution 2.

Tests in which known and unknown standards are used

Table 13.6 shows some of the other limit tests set in pharmacopoeial monographs ranging from a simple test for a known impurity to tests in which limits are set for more than one known impurity plus any unknown impurities which might be present.

Table 13.6 Some examples of pharmacopoeial limit tests

Analyte solution (Solution 1)	Limit test (Solution 2)	Limit test (Solution 3)	Limit test (Solution 4)
10 % w/v procaine.HCl	No secondary spot > 0.005% w/v <i>p</i> -amino benzoic acid	—	—
1% w/v triamcinolone acetonide	No secondary spot > 0.02% w/v triamcinolone acetonide	No other spots > 0.01% w/v triamcinolone acetonide	—
2% w/v promethazine.HCl	No secondary spot > 0.02% w/v isopromethazine.HCl	No other spots > 0.01% w/v promethazine.HCl	—
1% w/v chloramphenicol palmitate	No spot with the same R _f > 0.02% w/v chloramphenicol palmitate isomer.	No spot with the same R _f > 0.02% w/v chloramphenicol dipalmitate	No other spots > 0.005% w/v chloramphenicol palmitate

Perhaps the most detailed pharmacopoeial limit test of this nature is carried out on tetracycline where a 1% w/v solution is spotted onto the TLC plate with solutions of five structurally related tetracyclines ranging in concentration from 0.02–0.005% w/v.

High performance TLC (HPTLC)

HPTLC is conducted on TLC plates which are coated with purified silica gel with a particle range of 2–10 μm as opposed to 2–25 μm for standard commercial TLC plates. The narrower particle size range means that a greater number of theoretical plates are available for separation and thus the spots on the TLC plate remain tighter. These type of plates may be run in a standard type of TLC tank but optimal performance is obtained from horizontal development of the plates using apparatus of the type shown in Figure 13.10.

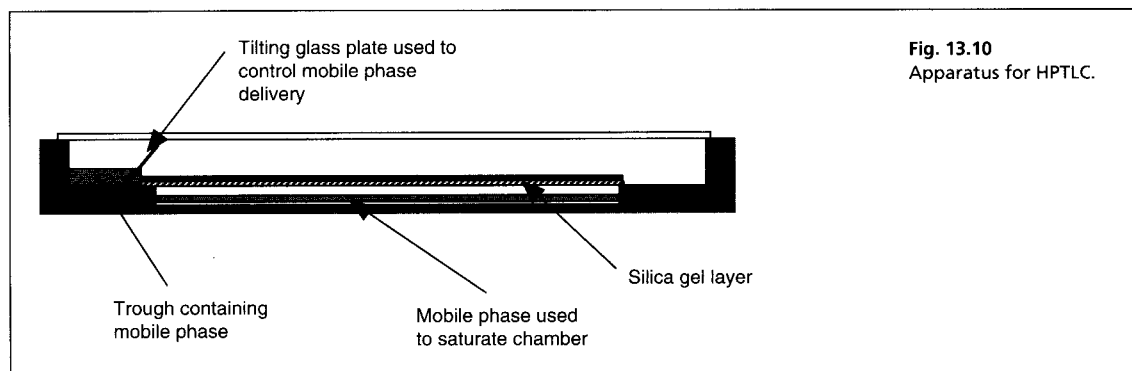

The advantages of horizontal development are:

- (i) The mobile phase moves more quickly.
- (ii) The proximity of the plate's surface to a saturating solution of mobile phase means that there is little evaporation of solvent from the surface of the plate, which in the case of vertical development can change the composition of the mobile phase as it moves up the plate.
- (iii) In the vertical position, if the plate is not in a saturated atmosphere, solvent at the edge of the plate tends to evaporate drawing solvent from the centre of the plate and causing the solvent at the edge of the plate to migrate more quickly. This does not occur when horizontal development is used.

Applications of HPTLC

It is possible to use TLC as a quantitative method by using a densitometer to read spot intensity. Quantitative TLC is best carried out using high-performance systems. Densitometers can be used to quantify components in a sample on the basis of fluorescence or absorption of UV light. As discussed above there are a number of advantages in using TLC and a major advantage is the ability to run batches of samples which give it an advantage over HPLC. HPTLC with fluorescence densitometry has been applied to the analysis of pharmacologically active thiols including the ACE inhibitor captopril.³ Compounds such as captopril do not have a strong chromophore and thus require derivatisation to render them detectable and this would be true whether HPLC or HPTLC were being used. In this example, the thiols were reacted with a thiol-specific reagent which produced fluorescent derivatives (Fig. 13.11) and were then analysed by TLC. Limits of detection for these compounds by this method were in the low picogram range.

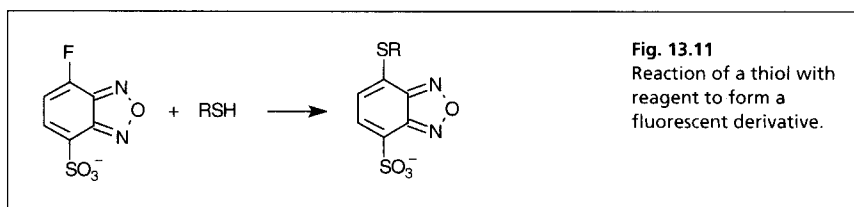
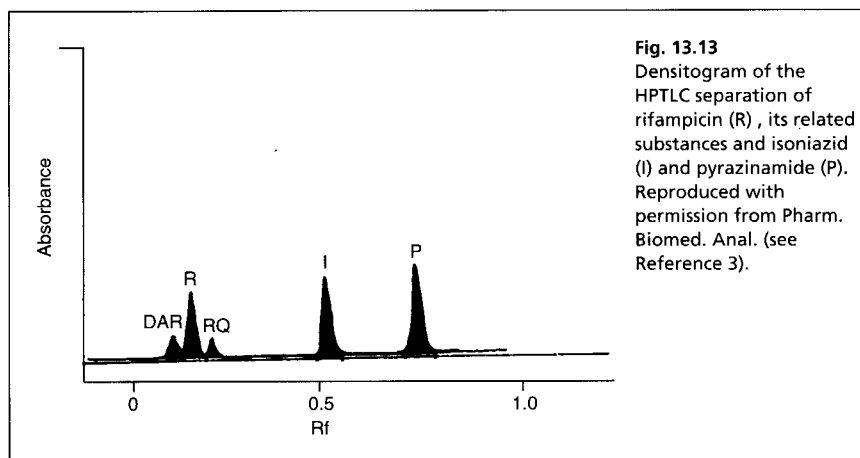
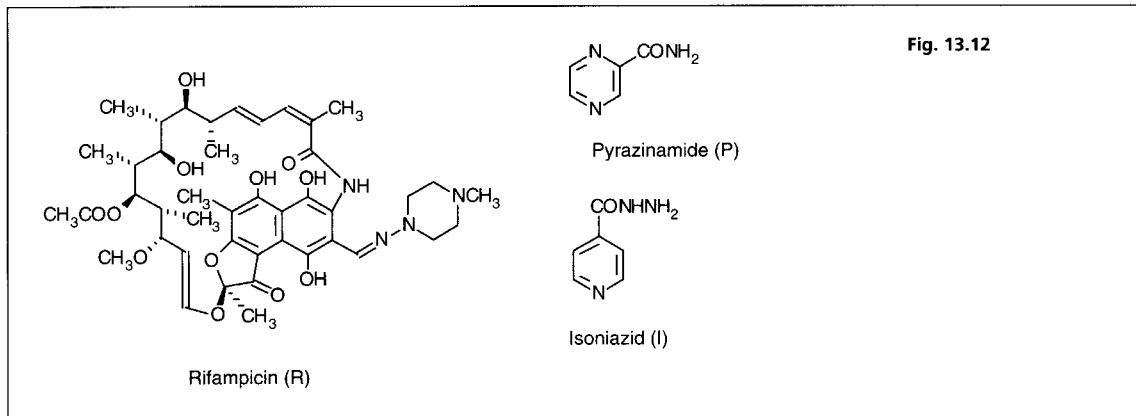

Fig. 13.11
Reaction of a thiol with reagent to form a fluorescent derivative.

An HPTLC assay for rifampicin (R), isoniazid (I) and pyrazinamide (P) (Fig. 13.12) in a single dosage form was reported.⁴ Pharmacopoeial methods only allow for the determination of each analyte in separate dosage forms. The HPTLC method was also able to resolve rifampicin from two of its named impurities. The analytes were quantified by densitometry by measuring absorbance at two different wavelengths. The precisions reported for quantification of the analytes were $R \pm 1.73$, $I \pm 1.58$ and $P \pm 1.07$, which compared quite favourably with an HPLC method for the same dosage form. Figure 13.13 shows a densitogram for R, its related substances, desacetyl rifampicin (DAR) and rifampicin quinone (RQ) and I and P. Thus HPTLC can be used for the quantitative analysis of mixtures which include large and complex molecules such as rifampicin.

It would be possible to run many current pharmaceutical limit tests with a much higher degree of accuracy and precision if HPTLC methods were used.



References

1. A.C. Moffat. Clarke's isolation and identification of drugs. Pharmaceutical Press, London (1986).
2. J.C. Touchstone. Practice of thin layer chromatography, 3rd Edn. Wiley Interscience, Chichester (1992).
3. B. Lin Ling, W.R.G Baeyens, B. Del Castillo, K. Imai, P. De Moerloose and K. Stragier. J. Pharm. Biomed. Anal. 7, 1663–1670 (1989).
4. A.P. Aregkar, S.S. Kuniyir and K.S. Purandare. J. Pharm. Biomed. Anal. 14, 1645–1650 (1996).

14

High-performance capillary electrophoresis

Keypoints	Applications of CE in pharmaceutical analysis	separation of anions on the basis of ionic radius
Introduction		
Electrophoresis	Separation of atenolol and related impurities predominantly on the basis of charge	Separation of peptides
EOF		Use of additives in the running buffer
Migration in CE		Applications of cyclodextrins in producing improvements in separation
Instrumentation	Separation predominantly on the basis of ionic radius	
Control of separation	Analysis of non-steroidal anti-inflammatory drugs (NSAIDs) by CE and	Micellar electrokinetic chromatography (MECC)
Migration time		
Dispersion		
		Additional problems

KEYPOINTS

Principles

Separation is carried out by applying a high potential (10–30 kV) to a narrow (25–75 μm) fused silica capillary filled with a mobile phase. The mobile phase generally contains an aqueous component and must contain an electrolyte. Analytes migrate in the applied electric field at a rate dependent on their charge and ionic radius. Even neutral analytes migrate through the column due to electro-osmotic flow, which usually occurs towards the cathode.

Applications

- An accurate and precise technique for quantitation of drugs in all types of formulations.
- Particular strength in quality control of peptide drugs.
- Highly selective and is very effective in producing separation of enantiomers.
- Very effective for impurity profiling due to its high resolving power.
- Very effective for the analysis of drugs and their metabolites in biological fluids.

Strengths

- Potentially many times more efficient than HPLC in its separating power.
- Shorter analysis times than HPLC.
- Cheaper columns than HPLC.
- Negligible solvent consumption.

Limitations

- Currently much less robust than HPLC.
- Sensitivity lower than HPLC.
- More parameters require optimisation than in HPLC methods.

Introduction

Electrophoresis

Capillary electrophoresis (CE) is the most rapidly expanding separation technique in pharmaceutical analysis and is a rival to HPLC in its general applicability. The instrumentation is quite straightforward, apart from the high voltages required, but the parameters involved in optimising the technique to produce separation are more complex than those involved in HPLC. The technique is preferred to HPLC where highly selective separation is required.

Separation of analytes by electrophoresis is achieved by differences in their velocity in an electric field. The velocity of an ion is given by the formula:

$$v = \mu_e E \quad \text{[Equation 1]}$$

where v is the ion velocity, μ_e is the electrophoretic mobility and E is the applied electric field.

The electric field is in volts/cm and depends on the length of the capillary used and strength of the potential applied across it. The ion mobility is given by the relationship shown below:

$$\mu_e = \frac{\text{Electric force } (F_E)}{\text{Frictional drag } (F_F)}$$

$$F_E = qE$$

where q is the charge on the ion and E is the applied electric field, i.e. the greater the charge on an ion the more rapidly it migrates in a particular electric field

For a spherical ion:

$$F_F = -6\pi\eta rv$$

where η is the viscosity of the medium used for electrophoresis, r is the ion radius and v is the ion velocity.

When the frictional drag and the electric field experienced by the ion are equal:

$$qE = -6\pi\eta rv$$

substituting this expression into Equation 1:

$$\mu_e = \frac{q}{6\pi\eta r} \quad \text{[Equation 2]}$$

If the applied electric field is increased beyond the point where the drag and electric field are equal, the ion will begin to migrate. From Equation 2 it can be seen that:

- (i) The greater the charge on the ion the higher its mobility.
- (ii) The smaller the ion the greater its mobility. Linked to this, since Equation 2 applies to a spherical ion, the more closely an ion approximates to a sphere, i.e. the smaller its surface area, the greater its mobility. This effect is consistent with other types of chromatography.

Thus the mobility of an ion can be influenced by its pK_a value; the more it is ionised the greater its mobility and its molecular shape in solution. Since its degree of ionisation may have a bearing on its shape in solution, it can be seen that the behaviour of analytes in solution has the potential to be complex. For many drugs

the manipulation of the pH of the electrophoresis medium should have a marked effect on their relative mobilities. Thus one would predict that the electrophoretic separation of the two bases (morphine and codeine), which are of a similar shape and size but have different pK_a values, would increase with pH. If we assume that morphine and codeine possess the same mobilities at full charge, then Figure 14.1 indicates how their mobilities vary with pH. As can be seen in Figure 14.1, the biggest numerical difference in mobility is when the $pH = pK_a$ of the weaker base although the ratio of the mobilities goes on increasing with pH, e.g. at pH 8.9 the ion mobility of codeine is *ca* two times that of morphine.

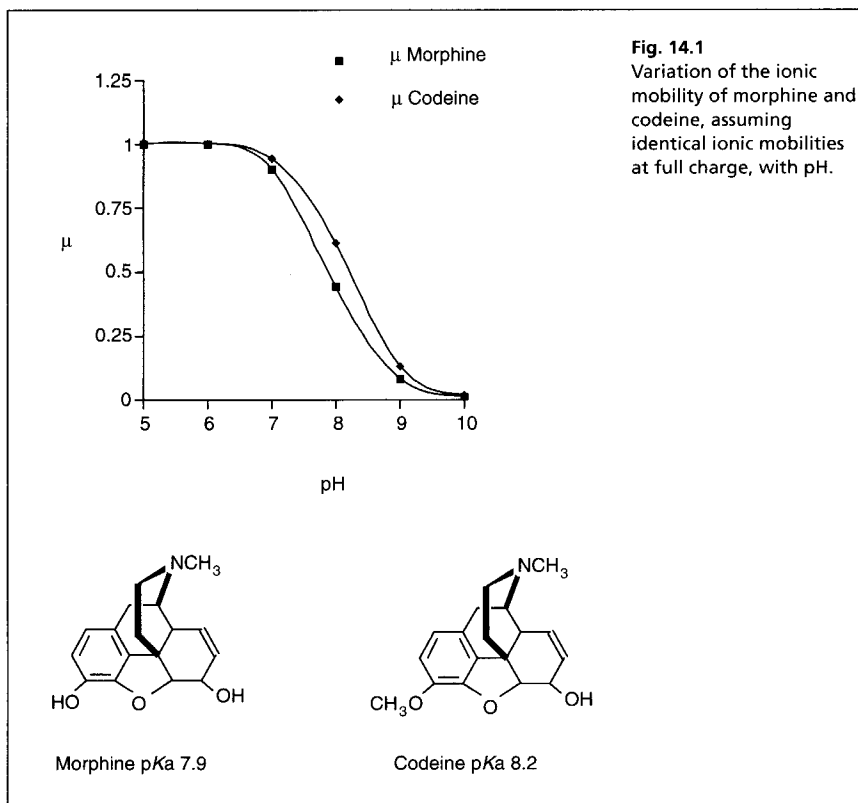

Variation of ion mobility with pH is only part of the story with regard to separation by capillary electrophoresis – the other major factor is electro-osmotic flow (EOF).

EOF

The wall of the fused silica capillary can be viewed as being similar to the surface of silica gel and at all but very low values the silanol groups on the wall will bear a negative charge. The pK_a of the acidic silanol groups ranges from 4.0–9.0 and the amount of negative charge on the wall will increase as pH rises. Cations in the running buffer are attracted to the negative charge on the wall resulting in an increase in positive potential as the wall is approached. The effect of the increased positive potential is that more water molecules are drawn into the region next to the

wall (Fig. 14.2). When a potential is applied across the capillary the cations in solution migrate towards the cathode. The concentrated layer of cations near to the capillary wall exhibit a relatively high mobility (conductivity) compared to the rest of the running buffer and drag their solvating water molecules with them towards the cathode creating EOF. The rate of EOF is pH dependent since the negative charge on the silanol groups increases with pH, and between a pH of 3 and 8 the EOF increases about 10 times. The EOF decreases with buffer strength since a larger concentration of anions in the running buffer will reduce the positive potential at the capillary wall and thus reduce the interaction of the water in the buffer with the cations at the wall.

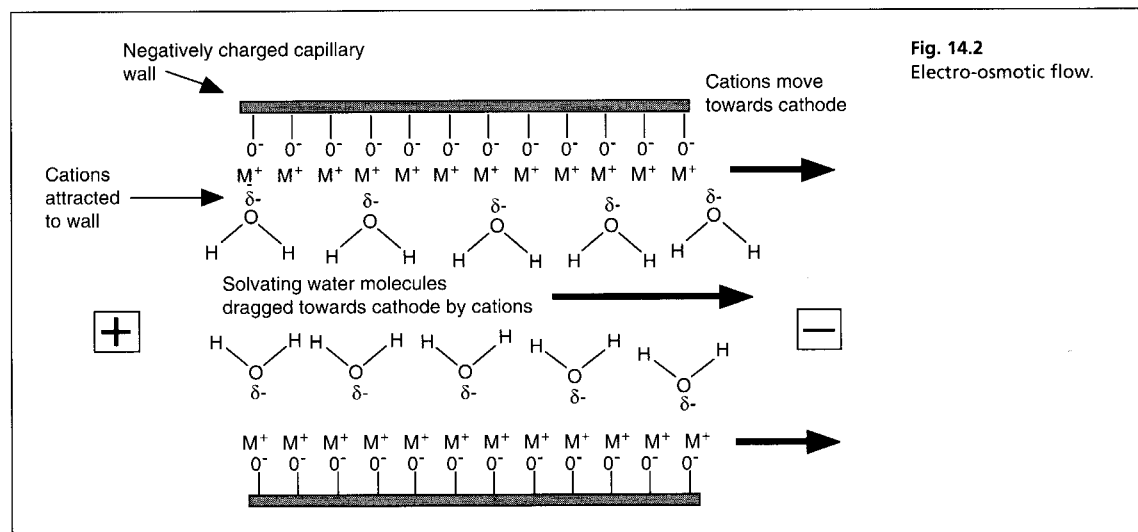

Fig. 14.2
Electro-osmotic flow.

The flow profile obtained from EOF is shown in Figure 14.3 in comparison with the type of laminar flow shown in HPLC. The flat flow profile produces narrower peaks than are obtained in HPLC separations and is a component in the high separation efficiencies obtained in capillary electrophoresis (CE).

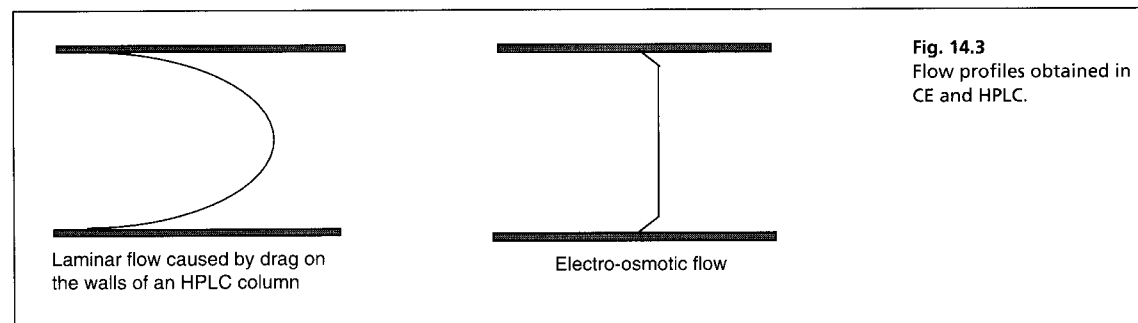

Fig. 14.3
Flow profiles obtained in CE and HPLC.

Migration in CE

The existence of EOF means that all species regardless of charge will move towards the cathode. In free solution, cations move at a rate determined by their ion mobility + the EOF. Neutral compounds move at the same rate as the EOF and anions move at the rate of the EOF - their ion mobility, the rate of EOF towards the cathode

exceeds the rate at which anions move towards the anode, by approximately ten times. A typical separation could be viewed as shown in Figure 14.4. The cations in solution migrate most quickly with the smaller cations reaching the cathode first; the neutral species move at the same rate as the EOF and the anions migrate most slowly with the smallest anions reaching the cathode last. The EOF is useful in that it allows the analysis of all species but it adds complexity to the method in that it needs to be carefully balanced against ion mobility. Table 14.1 shows how EOF can be controlled using different variables and illustrates some of the complexity of CE relative to HPLC.

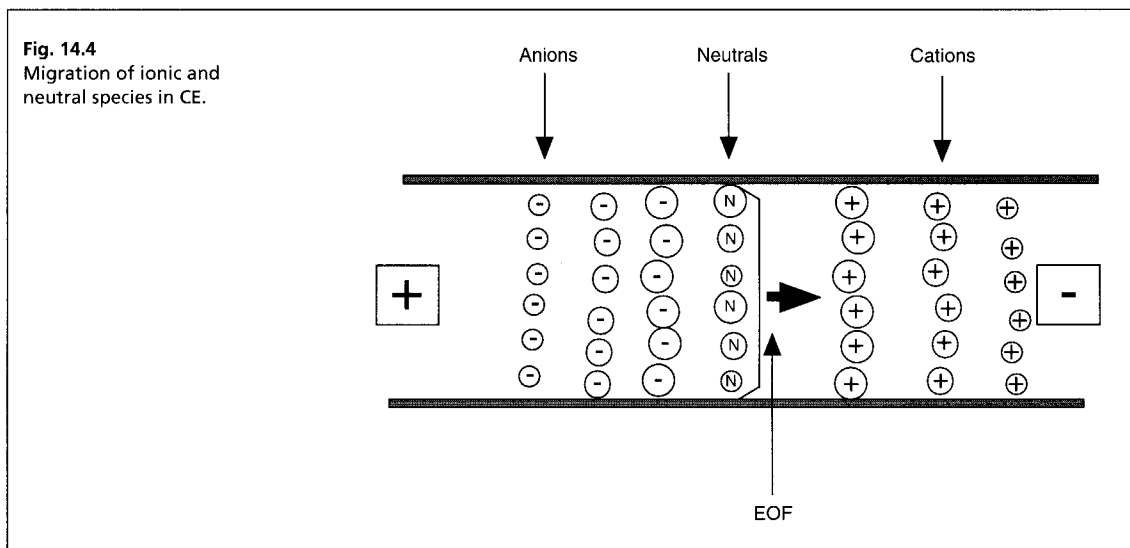

Table 14.1 Variables affecting EOF

Variable	Effects on EOF	Comments
Buffer pH	EOF increases with pH	Most convenient method for controlling EOF but has to be balanced against effects on the charge on the analyte
Buffer strength	EOF decreases with increasing buffer strength	(i) Increased ionic strength means increased electric current flow through the capillary, which can cause heating (ii) At low ionic strength more sample absorption onto the capillary walls occurs (iii) Low buffer concentrations reduce sample stacking following injection
Electric field	Increased electric field increases EOF	Lowering the applied electric field may reduce separation efficiency and raising the field strength may cause heating
Temperature	Increased temperature decreases viscosity and thus increases flow	Easy to control
Organic modifier	Changes potential at capillary wall – the dielectric constant of the running buffer and the viscosity. Usually decreases EOF	Complex effects – can be useful but best determined experimentally

Table 14.1 Variables affecting EOF (Cont.)

Variable	Effects on EOF	Comments
Surfactant	Absorbs onto the surface of the capillary wall	(i) Cationic surfactants have a high affinity for the silanol groups and thus block access by the smaller cations in solution reducing EOF. At high concentration they form a double layer giving the capillary wall an effective positive charge and causing EOF to reverse flow towards the anode
		(ii) Anionic surfactants reduce the access of the smaller ions in the running buffer to the positive potential at the wall thus increasing the zeta potential and thus EOF
Covalent wall coating	Can raise or lower EOF depending on the coating	(i) Neutral coatings reduce negative charge of the capillary wall thus reducing EOF
		(ii) Ionic coatings will have marked effects on EOF

Instrumentation

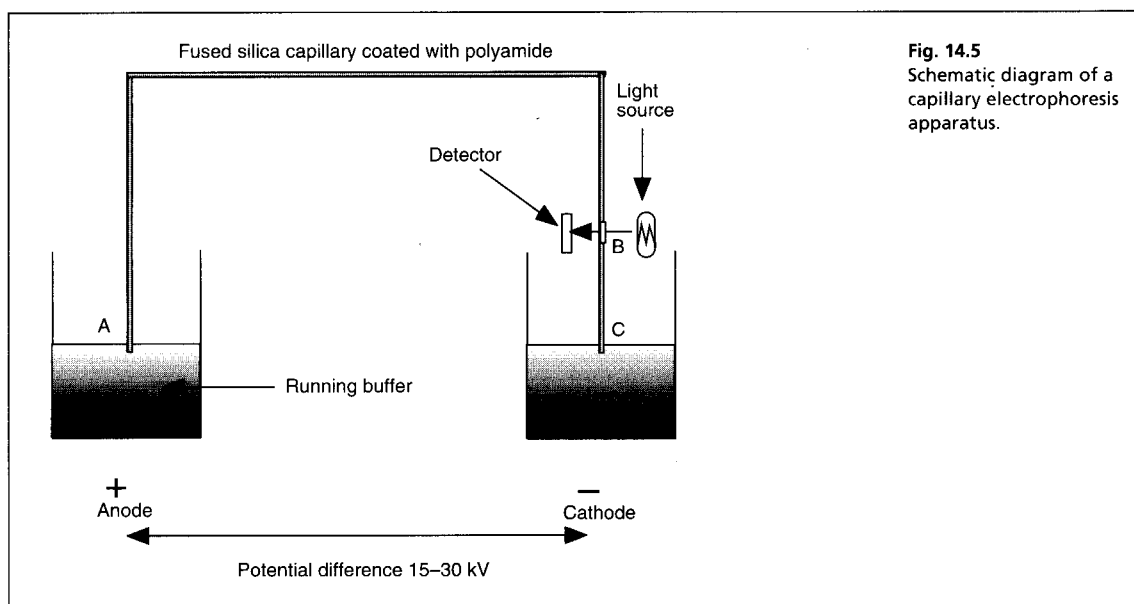

Fig. 14.5 Schematic diagram of a capillary electrophoresis apparatus.

A schematic diagram of a capillary electrophoresis instrument is shown in Figure 4.5. The fundamentals of the system are as follows:

- (i) Injection is commonly automated and is usually accomplished by pressuring the vial containing the sample with air.
- (ii) Having loaded the sample the capillary is switched to a vial containing running buffer. The flow rate of the running buffer through the capillary is in the low nanolitres/min range.
- (iii) The capillaries are like those used in capillary gas chromatography with a polyamide coating on the outside. The length of the capillaries used is 50–100 cm with an internal diameter of 0.025–0.05 mm. They are generally wound round a cassette holder so that they can simply be pushed into place in the instrument.

- (iv) At the detector end the capillary has a window burnt into it so that it is transparent to the radiation used for detection of the analyte.
- (v) The most commonly used detector is a diode array or rapid scanning UV detector although fluorometric, conductimetric and mass spectrometric detectors are available.

Control of separation

Migration time

As discussed earlier, cations move most quickly towards the point of detection and time has to be allowed for separations to develop and the EOF should not exceed the cationic mobility by an amount which is incompatible with achieving separation. The factors which can be used to control EOF have been discussed earlier. Another factor in allowing separation to develop which is simply controlled is the length of the capillary; however, the longer the capillary in relation to a fixed applied potential the lower the electric field which is in volts/cm. Since the detection system is mounted before the column outlet, it is important that the distance between the detector and the outlet is not too great since the effective length of the capillary is reduced.

Dispersion

Longitudinal diffusion

This is generally the most important cause of peak broadening in CE because of the absence of mass transfer and streaming effects seen in other types of chromatography. Thus to some extent CE resembles capillary gas chromatography but with less mass transfer effects and lower longitudinal diffusion since the sample is in the liquid phase. Longitudinal diffusion depends on the length of time an analyte spends in the capillary and also on the diffusion coefficient of the analyte in the mobile phase. Large analytes such as proteins and oligonucleotides have low diffusion coefficients and thus CE can produce very efficient separations of these types of analyte.

Injection plug length

The capillaries used in CE have narrow internal diameters. For a 100 cm \times 50 μm i.d. capillary an injection of 0.02 μl would occupy a 1 cm length of capillary space. Automatic injection can overcome difficulties in reproducible injection of such small volumes but often detection limits require that larger amounts of sample are injected. Typically the injection is accomplished by applying pressure at the sample loading end of the capillary. An important element in accomplishing efficient sample loading, particularly if detection limits are a problem and a larger volume of sample has to be loaded, is stacking. A simple method for achieving stacking is to dissolve the sample in water or low conductivity buffer. The greater resistance of the water plug causes a localised increase in electrical potential across the plug width and the sample ions dissolved in the plug will migrate rapidly until the boundary of the running buffer is reached. By using this method, longer plugs up to 10% of the capillary length can be injected, resulting in an increase in detection limit.

Joule heating

The strength of the electric field which can be applied across the capillary is limited by conversion of electrical energy into heat. Localised heating can cause changes in

the viscosity of the running buffer and a localised increase in analyte diffusion. Heat generation can be minimised by using narrow capillaries where heat dissipation is rapid and by providing a temperature-controlled environment for the capillary.

Solute wall interactions

Analytes may adsorb onto the wall of the capillary either by interaction with the negatively charged silanol groups or by hydrophobic interaction. High ionic strength buffers block the negative charge on the capillary wall and reduce the EOF but also increase heating. If only analysis of cations is required, the pH of the running buffer can be lowered, e.g. to pH 2. The low pH suppresses the charge on the silanol groups, reduces EOF to a low level but ensures full ionic mobility of the cations, which will migrate to the cathode without the aid of the EOF. Full ionisation of the analytes does not allow for differences in pK_a to be used in producing separation.

Electrodispersion

The mobility of the running buffer has to be fairly similar to the mobility of the ions in the sample zone. If the mobility of the analyte ions is greater than the mobility of the buffer ions, a fronting peak will result since the ions at the front of the sample zone tend to diffuse into the running buffer solution where they experience a greater applied electric field (due to the higher resistance of the buffer compared with the sample) and accelerate away from the sample zone. This effect will be less if the concentration of the running buffer is much greater than that of the sample. Conversely, if the mobility of the sample ions is lower than that of the running buffer ions, a tailing peak will be produced because the ions in the rear of the sample zone will tend to diffuse into the buffer where they will experience a lower applied electric field (due to the lower resistance of the buffer compared with the sample) and will thus lag further behind the sample zone. This effect will be less if the concentration of the running buffer is much lower than that of the sample zone.

Applications of CE in pharmaceutical analysis

In its simplest form capillary electrophoresis is termed 'capillary zone electrophoresis'. The conditions used in this type of analysis are relatively simple and the mobile phase used consists of a buffer with various additives. Many applications focus on critical separations which are difficult to achieve by HPLC. In many cases it is difficult to explain completely the types of effects produced by buffer additives.

Separation of atenolol and related impurities predominantly on the basis of charge

The β -blocker atenolol is shown in Figure 14.6 with its principal known impurities. These impurities are not readily separated from atenolol by HPLC because of their close structural similarity.¹

The separation was carried out using a 0.05 mm \times 50 cm capillary at 15 kV with a phosphate/borate running buffer. Figure 14.6 shows separation at the optimal pH of 9.7 of atenolol (50 $\mu\text{g}/\text{ml}$) from its impurities spiked into solution at concentrations of 5 $\mu\text{g}/\text{ml}$. The elution order is as would be predicted from the ionisable groups in the molecules. Atenolol (AT) elutes first since it bears a positive charge on the basic secondary amine group (pK_a 9.6). The dimer (TA) also carries one positive charge

Fig. 14.6

Separation of atenolol and its principal impurities by CE. Reproduced with permission from J. Pharm. Biomed. Anal. (see Reference 1).

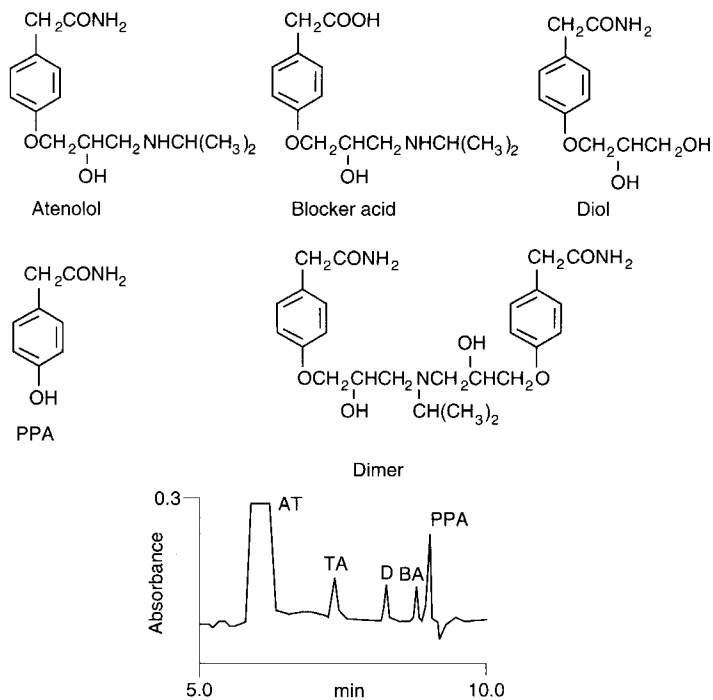

but it is a tertiary amine and has a lower pK_a than atenolol; it is also a larger ion thus its mobility will be less than that of atenolol (size was sufficient to cause separation of these two molecules at pH 6.5 where both atenolol and the dimer would be fully charged). The diol (D) is a neutral compound and thus should elute at the same rate as the EOF, which will increase with pH. However, in the paper under discussion the elution time of the diol increased with pH; this may be due to complex formation with the borate in the running buffer, which will tend to form a negatively charged complex with a diol. The blocker acid (BA) bears both a positive and a negative charge, which more or less neutralise each other over a quite wide pH range, as the pH rises towards the pK_a of the amine group (*ca* 9.5) the negative charge of the acidic group becomes predominant; although the molecule will still bear some positive charge, the overall negative charge will cause the molecule to lag behind the EOF. Finally the phenol (PPA) is neutral until its pK_a value (*ca* 9.7–10) is approached and at higher pH values it will develop a negative charge slowing down its rate of migration; this is consistent with Figure 14.6.

Separation predominantly on the basis of ionic radius

Very small changes in molecular structure can lead to quite marked differences in retention time in CE. An impressive separation of the experimental anti-depressant drug GR50360 from a number of impurities was achieved using isopropanol/0.01 M phosphate buffer pH 7.0 (1:4).² In this case the separation is due largely to molecular size or shape since at pH 7.0 the drug and its impurities will be charged to a similar extent.

Self-test 14.1

Metipranolol and its possible manufacturing impurities are separated using CE in a buffer at pH 9.5. Suggest the likely order of elution for the components in the mixture.

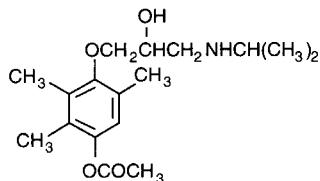

1 Metipranolol pKa 9.5

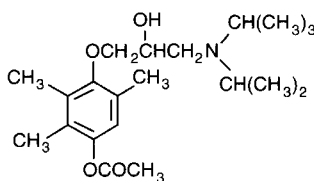

2 Tertiary amine pKa 9.1

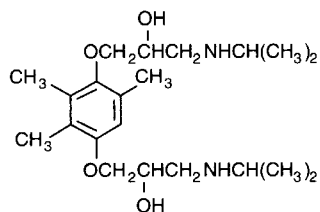

3 Diamine pKa 9.5

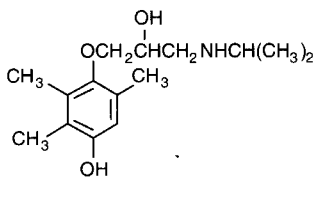

4 Phenol pKa 9.5, 10.0

Answer: Order of elution: 3, 1, 2, 4

Figure 14.7 shows the separation of all six components by CE. The *cis* isomer of GR50360A has a completely different molecular shape from the *trans* isomer, resulting in a smaller ionic radius and thus it runs earlier than the *trans* isomer. Otherwise the compounds elute in order of molecular size, the desfluorocompound being the first of the derivatives of GR50360A to elute. The presence of the isopropanol in the mobile phase slows down the EOF sufficiently for separation to develop.

Analysis of non-steroidal anti-inflammatory drugs (NSAIDs) by CE and separation of anions on the basis of ionic radius

NSAIDs generally contain a carboxylic acid group and when ionised they are anions. In CE using an unmodified capillary the EOF is towards the cathode and the overall mobility of anions is given by the EOF – the mobility of the anions which is towards the anode. In this example³ the running buffer used in the analysis was carefully designed with respect to its ionic content to avoid electrodispersion. Glycine was found to have a suitable mobility for the analysis of this class of compound because, although it is a small molecule with a carboxylic acid group which is completely ionised at the pH of the analysis (9.1), it also bears a partial positive charge reducing its overall mobility towards the anode and giving it a mobility similar to those of the large lipophilic NSAID acids. The cationic component in the buffer was also found to have an important effect on resolution of the components in a mixture containing four NSAIDs. Triethanolamine was found to be the best cationic component since it reduced EOF because of its relatively low ion mobility and also through increasing the viscosity of the running buffer. Figure 14.8 shows the separation of a mixture containing five NSAIDs: sulindac (S), indomethacin (I), piroxicam (P), tiaprofenic

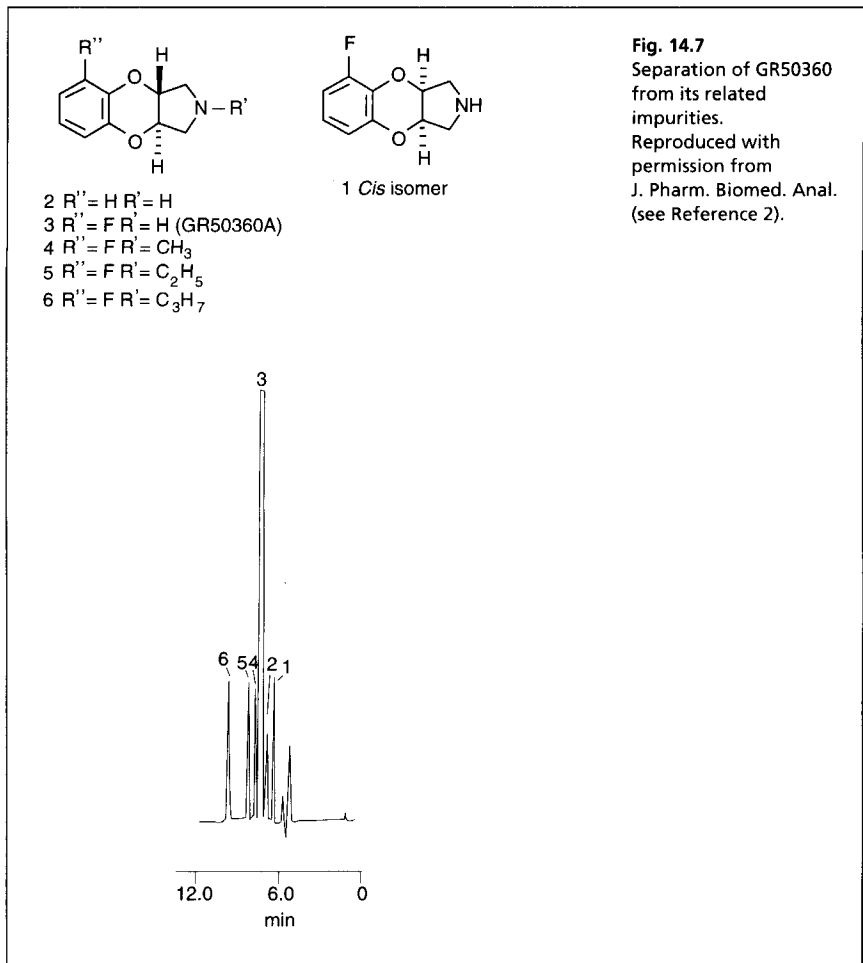
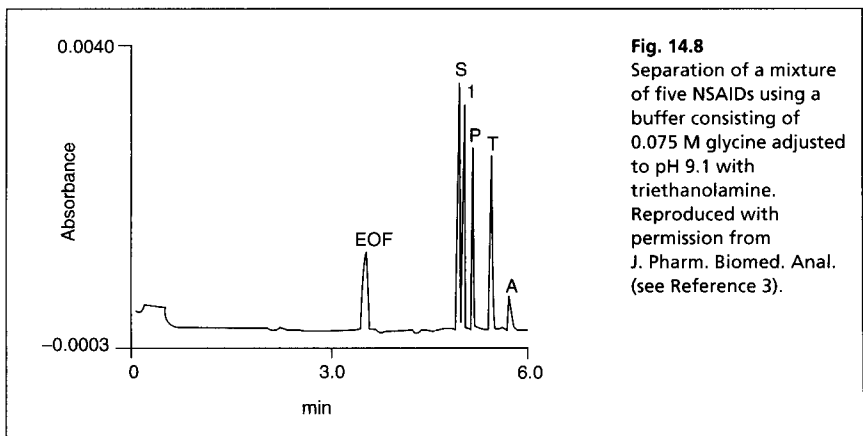

Fig. 14.7
 Separation of GR50360
 from its related
 impurities.
 Reproduced with
 permission from
 J. Pharm. Biomed. Anal.
 (see Reference 2).



acid (T) and aclofenac (A). All the drugs are fully charged at pH 9.1 and the separation was achieved more or less according to molecular weight with aclofenac, the smallest molecule, migrating most rapidly in the opposite direction to the EOF.

Separation of peptides

A particular strength of CE is its ability to separate peptides. The use of therapeutic peptides is increasing rapidly and their large size and polarity present particular problems in producing separations. Because peptides usually bear two or more charges, the most important factor to optimise in peptide separations is the pH and concentration of the running buffer. The *pI*-value of a peptide is the pH where its positive and negative charges are balanced. An example is provided by the separation of adrenocorticotrophic hormone (ACTH) from three of its fragments.⁴

Table 14.2 shows the molecular weights and *pI*-values of ACTH and three of its fragments. The *pI*-value gives some indication of the relative number of acidic and basic groups in the peptide; a high *pI*-value indicates a peptide with a large number of basic residues such as lysine and arginine, while a low *pI*-value indicates that the balance is in favour of acidic residues such as glutamic and aspartic acids. In this particular example, conditions (pH 3.8) were chosen where the charge on the basic residues was predominant although at this pH, acidic residues will still bear an appreciable negative charge inhibiting migration towards the cathode. In the current example the separation is consistent with the balance of basic and acidic character in the peptide. The most basic peptide (fragment 1) elutes first whereas the least basic peptide elutes last. Thus in this case the degree of positive charge on the peptides predominates over ionic radius in determining the rate of migration since ACTH migrates more quickly than fragment 3 despite having a much higher molecular weight. The separation was optimised by increasing buffer strength, as can be seen from Figure 14.9 and increased buffer strength gave increased migration time through its effects in reducing EOF. Another important effect of the increased buffer strength in this case is the reduction of the interaction of these highly basic peptides (particularly fragments 1 and 2 and ACTH) with the silanol groups on the capillary wall thus resulting in better peak shape.

Table 14.2 Characteristics of ACTH and its peptide fragments

Peptide	<i>pI</i> -value	Molecular weight	No. of amino acids	Calculated mobility	Migration order
Fragment 1	11.69	1652	14	0.0431	1
Fragment 2	10.05	2934	24	0.0379	2
ACTH	9.24	4567	39	0.0216	3
Fragment 3	7.55	1299	10	0.0151	4

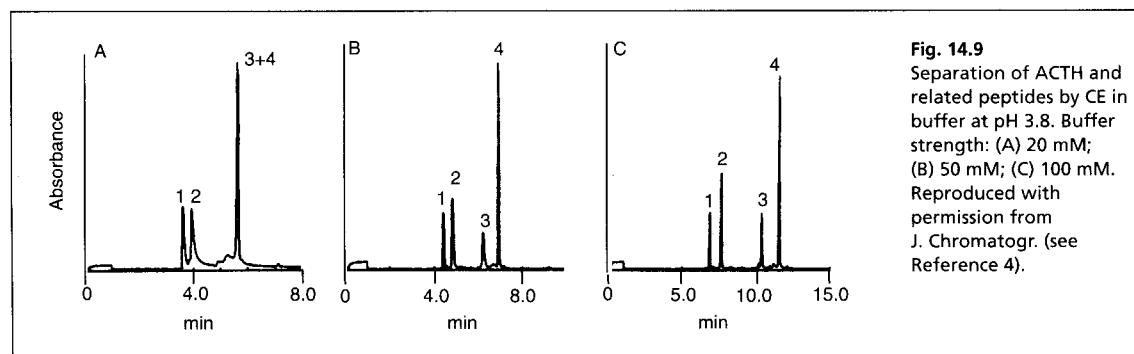

Fig. 14.9 Separation of ACTH and related peptides by CE in buffer at pH 3.8. Buffer strength: (A) 20 mM; (B) 50 mM; (C) 100 mM. Reproduced with permission from J. Chromatogr. (see Reference 4).

In this elegant study it was concluded that for all the peptides studied the best separations were achieved in buffers of medium to high strength (0.05–0.1 M), thus allowing manipulation of EOF without moving away from the optimal pH for the running buffer. It was also concluded that acidic pH values in the range of 2.2–3.8 were best for analysis of basic and neutral peptides whereas acidic peptides were best run at around pH 7.0.

Use of additives in the running buffer

Additives in the running buffer can produce greater selectivity where separation in simple free solution is not possible.

Applications of cyclodextrins in producing improvements in separation

Cyclodextrins are neutral compounds which migrate at the same rate as the EOF. They have large hydrophobic cavities in their structures into which molecules can fit. The ease with which a molecule fits into the cavity of the cyclodextrin is dependent on its stereochemistry. Cyclodextrins have been used as additives both in chiral, where opposite enantiomers form transient diastereomeric complexes with the optically active cyclodextrins, and non-chiral separations where the cyclodextrins affect diastereoisomers to a different extent.

Separation of pilocarpine from its epimer

Pilocarpine (P), a drug used in treating glaucoma, can potentially contain its epimer, isopilocarpine (I) as an impurity. In a study it was not possible to completely separate pilocarpine and isopilocarpine by variation of the pH of the running buffer. The optimal pH for separation should be 6.9 where both compounds are *ca* 50% ionised but even at this pH separation was incomplete.⁵

Fig. 14.10
Separation of pilocarpine and isopilocarpine by inclusion of β -cyclodextrin, the running buffer. (A) With addition of cyclodextrin. (B) Without addition of cyclodextrin. Reproduced with permission from *J. Chromatogr.* (see Reference 5).

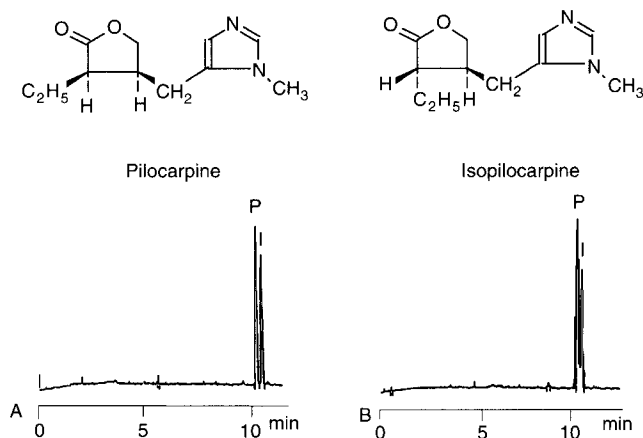

Inclusion of 0.01 M β -cyclodextrin in the running buffer resulted in baseline separation of the diastereoisomers. Figure 14.10A shows the separation of the two epimers achieved following addition of the cyclodextrin to the running buffer. In this

example capillaries were used where the silanol groups on the capillary wall had been partially blocked by coating, reducing the negative charge on the wall and thus reducing the EOF and allowing more time for separation to develop. In the present example the separation is achieved by the different degree of complexation of the β -cyclodextrin additive with the two diastereoisomers.

Separation of chiral local anaesthetics

Cyclodextrins are used in GC and HPLC to effect separation of enantiomers and they are also very effective in CE applications. The application of CE to chiral separations will undergo rapid growth in the next few years because of the high efficiencies that can be achieved in such separations using this technique and because of the cheapness of the chiral additives compared to the cost of chiral GC and HPLC columns. A series of enantiomers of local anaesthetics was separated by CE using a phosphate buffer at pH 3.0 containing triethanolamine as a cationic additive and 10 mM of a dimethyl β -cyclodextrin.⁶ The addition of the cationic additive reversed the EOF (see Table 14.1) towards the anode, however, the analytes still migrated towards the cathode, having an overall mobility in this direction greater than the EOF towards the anode. This allowed increased time for interaction of the analytes with the cyclodextrin which migrates towards the anode with the EOF. The use of methylated β -cyclodextrin increases the interaction of lipophilic analytes with this chiral selector compared with β -cyclodextrin itself.

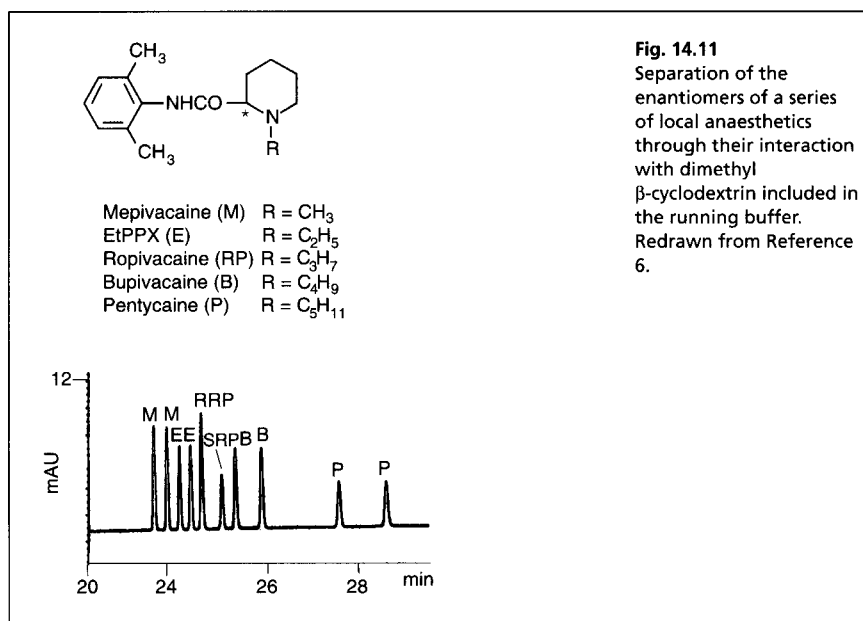

Figure 14.11 shows the separation of R and S isomers of a series of structurally related local anaesthetics. Wide separations were achieved for the compounds in this series where it was proposed that the fit of the hydrophobic portion of the analyte into the cyclodextrin was optimal when one of the substituents at the chiral centre was able to interact with the chiral hydroxyl groups on the rim of the cyclodextrin cavity. Table 14.3 shows the association constants calculated for the interaction of the enantiomeric pairs with the dimethylcyclodextrin.⁶ The larger the value of K , the

more the enantiomer is retarded by the selector, which in this case is migrating towards the anode. The values in the table also show that the calculated mobilities for each analyte in free solution decrease with the bulk of the N-alkyl substituent.

Table 14.3 Association constants of some enantiomers of some local anaesthetics with dimethyl β -cyclodextrin and their mobilities in free solution

Compound	K_1 (L mol ⁻¹)	K_2 (L mol ⁻¹)	μ (10 ⁻⁸ m ² s ⁻¹ v ⁻¹)
Mepivacaine	18	24	1.96
Ropivacaine	18	26	1.82
Bupivacaine	16	26	1.77

Micellar electrokinetic chromatography (MECC)

This extension of the basic CE technique allows the separation of neutral components to be carried out, but it has also been widely used in achieving separations of ionic species. In MECC, a surfactant is added to the mobile phase at a concentration above its critical micelle concentration. The surfactants used can be anionic, cationic or neutral. The micelles act in a manner analogous to the stationary phase in HPLC. Anionic micelles migrate in the opposite direction to the usual EOF, which is towards the cathode. Cationic micelles migrate with the EOF and neutral micelles migrate at the same rate as the EOF. The presence of the surfactant in the running buffer also has an effect on the rate and direction of EOF via interaction with the capillary wall so that the final basis for separation in MECC may be due to a number of mechanisms. The interaction of the analyte with the micelles may be modified using organic solvent additives in the running buffer which reduce the partitioning of the analyte into the micelle; at the same time such organic modifiers tend to reduce EOF. The formation of micelles is illustrated in Figure 14.12.

Fig. 14.12
Micelle formation during MECC and the effect of charged micelles on the rate of migration of a neutral compound relative to the EOF.

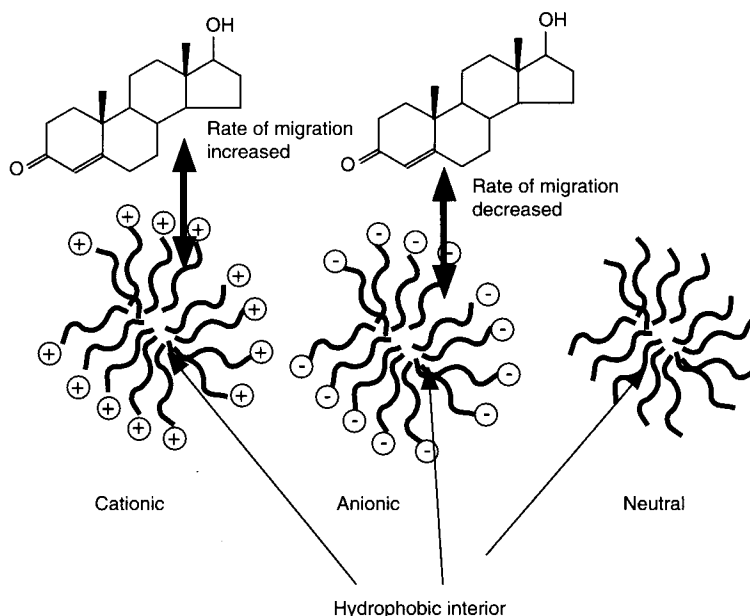

Separation of cefotaxime from related impurities.

Penicillins and cephalosporins are reactive compounds and may contain a number of degradants; the high selectivity of CE can be advantageous where separation of complex mixtures is required. Some of the impurities may be neutral and separation of neutral impurities from each other requires partitioning into charged micelles which migrate at a different rate from the EOF. In this particular application sodium dodecyl sulphate (SDS), an anionic surfactant, was used to conduct MECC.⁷ The pH of the running buffer was 7.2, which was low enough to avoid promoting the degradation of cefotaxime, which is unstable to alkali. Cefotaxime and its related impurities are shown in Figure 14.13.

Figure 14.14A shows the MECC trace obtained from C which was spiked with 0.2% w/w of each impurity and Figure 14.14B shows an unspiked sample of C. The slowest migrating compound was the neutral lactone compound L, which should have the most affinity for the negatively charged and hydrophobic SDS. The other impurities are carboxylic acids which will be fully charged at pH 7.2, thus bearing a negative charge, which will cause some degree of repulsion between the analytes and the negatively charged micelles. The anti-isomer of C is late eluting because of its stereochemistry, hence its ionic radius and partition coefficient are quite different

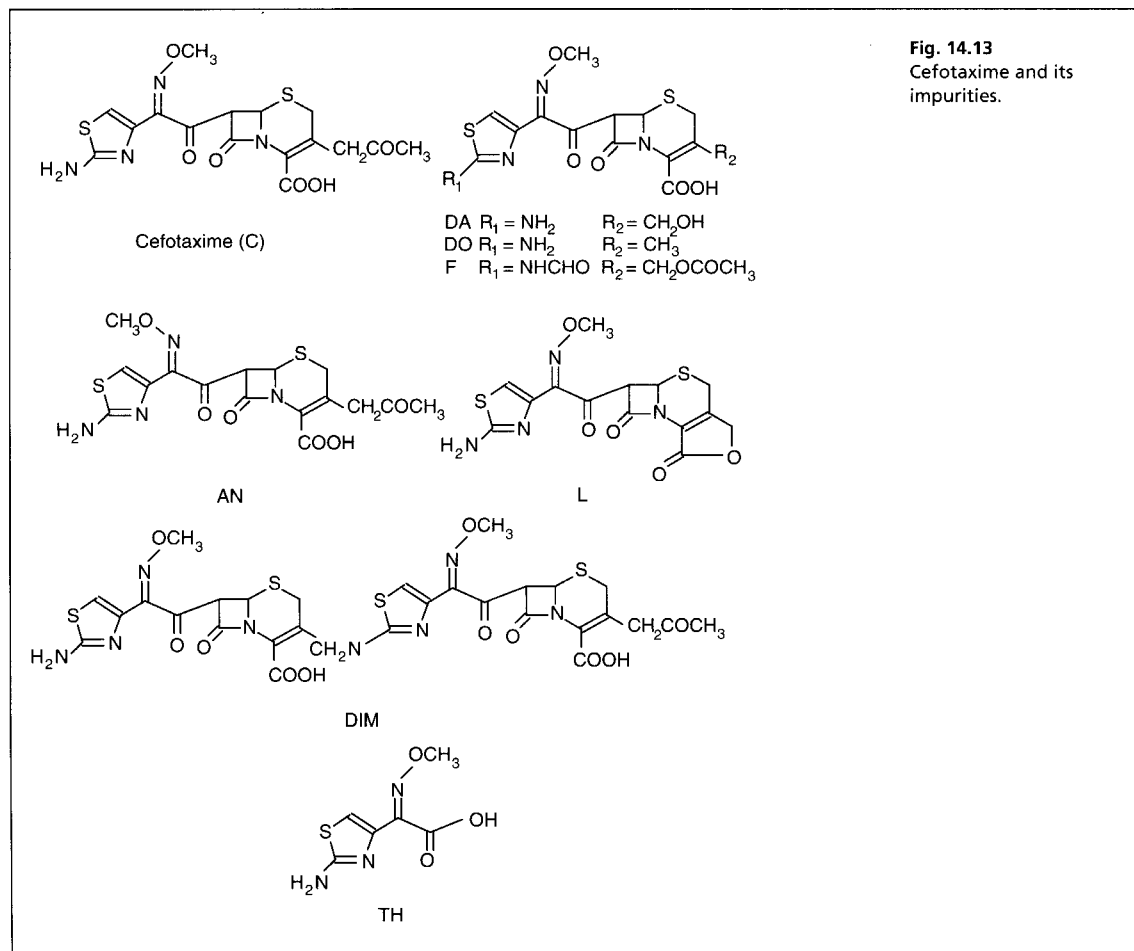
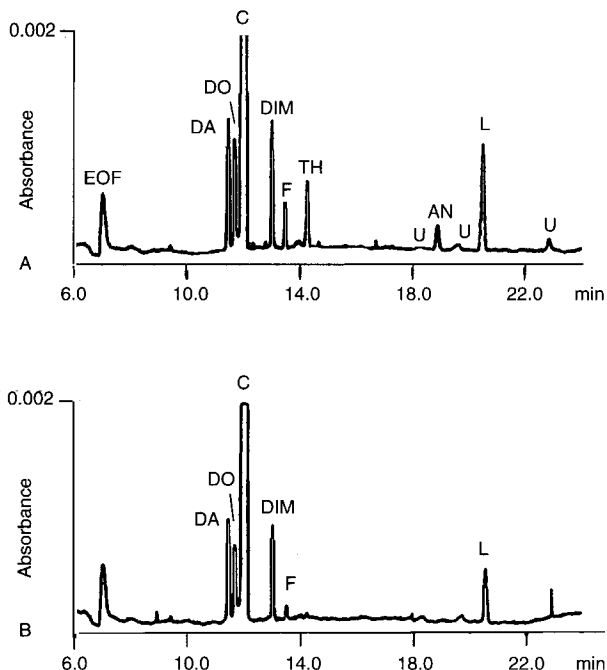

Fig. 14.14
Separation of cefotaxime and related impurities. (A) Sample spiked with impurities. (B) Unspiked sample. U = unknown. Reproduced with permission from Chromatographia (see Reference 7).



from those of C (this is consistent with a lack of antibiotic effect for the anti-isomer). The MECC method was capable of producing separation of all seven impurities from C at the 0.2% level; it gave precision comparable to a previously developed HPLC method and was more rapid than the HPLC method.

Analysis of flavonoids by MECC

Flavonoids are natural products which occur in certain popular herbal medicines such as *Ginkgo biloba*. They are phenols and are not charged until the pH of the running buffer is high. Separation by MECC was carried out using 0.04 M SDS in a 0.02 M borate running buffer at pH 8.2.⁸ At this pH the flavonoids studied are more or less uncharged and in the absence of differential partitioning would migrate at the same rate as the EOF. The presence of SDS in the running buffer slows down the rate of migration of these compounds according to how strongly they partition into the SDS micelles, which are moving towards the anode while the EOF is towards the cathode. Figure 14.15 shows the closely related structures of the flavonoids whilst Figure 14.16 shows the separation achieved for a model mixture of these compounds.

The method gave good precision and rapid separation of the mixture. Chromatography of these types of compounds normally requires the use of gradient HPLC with long elution times.

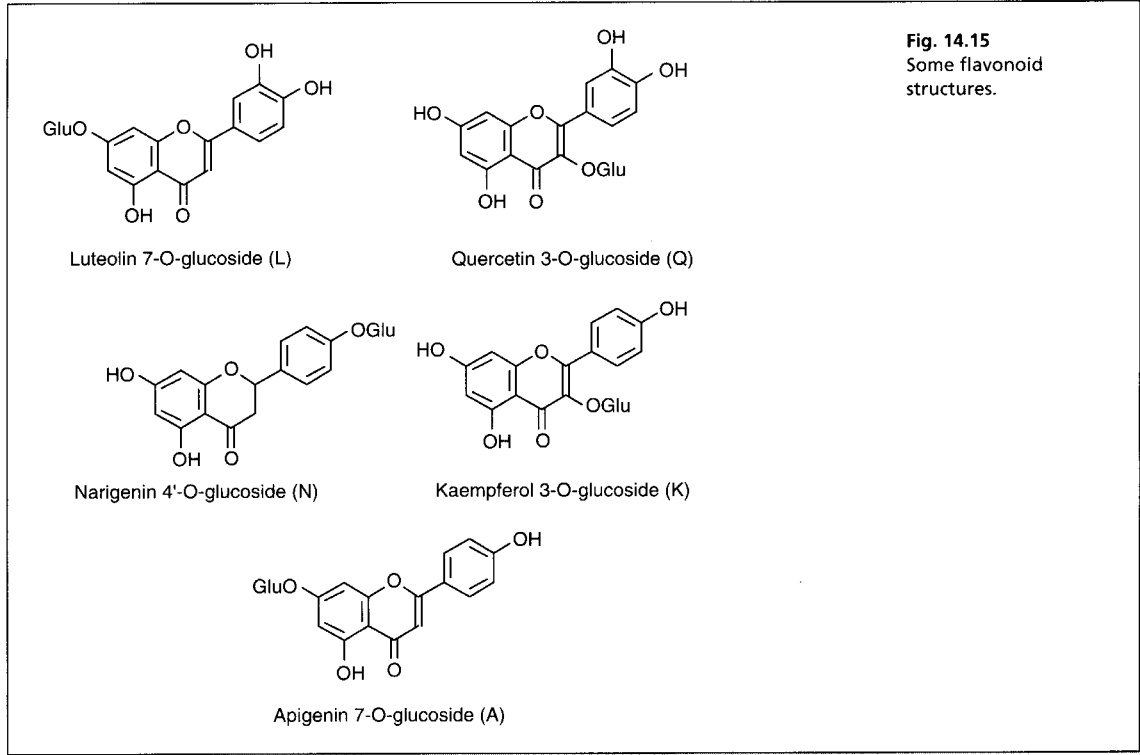
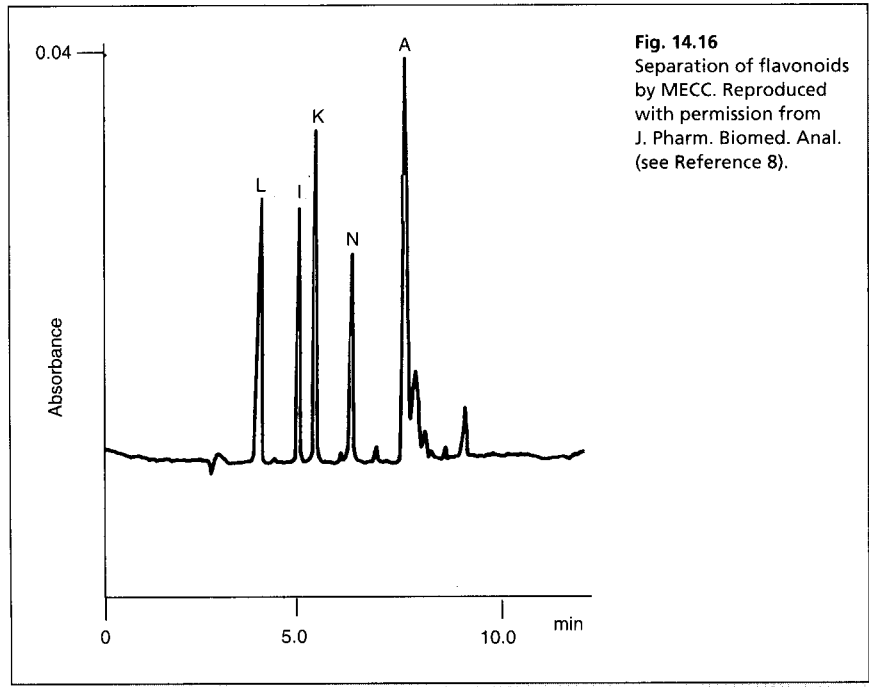

Fig. 14.15
 Some flavonoid structures.



Additional problems

- Select the most suitable running buffer from those given below to accomplish efficient separation of the following mixtures:
 - Two geometrical isomers of a basic drug pK_a 9.7.
 - A mixture of neutral corticosteroids.
 - A mixture of opium alkaloids with pK_a values in the range 7.5–8.5.
 - Two enantiomers of a local anaesthetic pK_a 8.0.
 - Two proteins both of ca 20 000 MW, one with a pI -value of 5.5 and the other with a pI -value of 7.1.
 - Human and porcine insulin – human insulin differs from porcine insulin by one amino acid having a more polar threonine residue in place of an alanine residue and their pI -values are the same.
 - 0.05 mM phosphate buffer pH 7.5 containing 0.05 mM SDS.
 - 0.02 mM borate buffer pH 9.5 containing 0.01 mM β -cyclodextrin.
 - 0.05 mM phosphate buffer pH 6.5.
 - 0.05 mM phosphate buffer pH 8.0.
 - 0.02 mM borate buffer pH 8.0 containing 0.01 mM propylcyclodextrin.

Answers: (i) (ii) (iii) (iv) (v) (vi) a or d; (vii) e; (viii) c (ix) a

- Predict the order of elution of the the following tricyclic anti-depressants from a CE system with the following running buffer: 0.5 mM buffer pH 9.55/methanol (84.6:15.4).

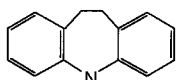

CH₂CH₂CH₂NHCH₃

Desipramine pK_a 10.2
and < 3

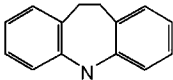

CH₂CH₂CH₂N(CH₃)₂

Imipramine pK_a 9.5
and < 3

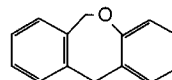

CH₂CH₂CH₂N(CH₃)₂

Doxepin pK_a 9.0

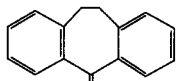

CH₂CH₂CH₂NHCH₃

Nortriptyline pK_a 9.7

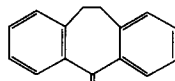

CH₂CH₂CH₂N(CH₃)₂

Amitriptyline pK_a 9.4

Answers: desipramine, nortriptyline, imipramine, amitriptyline, doxepin

References

- A. Shafaati and B.J. Clark. *J. Pharm. Biomed. Anal.* 14, 1547–1554 (1996).
- N.W. Smith and M.B. Evans. *J. Pharm. Biomed. Anal.* 12, 579–611 (1994).
- I. Bechet, M. Fillet, Ph. Hubert and J. Crommen. *J. Pharm. Biomed. Anal.* 13, 497–503 (1995).
- M.H.J.M. Langenhuizen and P.S.L. Janssen. *J. Chromatogr.* 638, 311–318 (1993).
- W. Baeyens, G. Weiss, G. van der Weken and W. van den Bossche. *J. Chromatogr.* 638, 319–326 (1993).
- C.F. Stänger-van de Griend, K. Gröningsson and D. Westerlund. *Chromatographia.* 42, 263–267 (1996).
- G.C. Penalvo, E. Julien and H. Fabre. *Chromatographia.* 42, 159–164 (1996).
- P. Pietta, R. Mauri, R.M. Facino and M. Carini. *J. Pharm. Biomed. Anal.* 10, 1041–1045 (1992).
- K. Salomon, D.S. Burgi and J.C. Helmer. *J. Chromatogr.* 549, 375–385 (1991).

Further reading

Capillary Electrophoresis. D.R. Baker. Wiley Interscience, Chichester (1995).
 Capillary Electrophoretic Separations of Drugs. A.S. Cohen, S. Terabe and Z. Deyl. Elsevier, Amsterdam (1996).

15

Extraction methods in pharmaceutical analysis

Introduction

Commonly used excipients in formulations

- Tablets and capsules
- Suspensions and solutions
- Creams and ointments

Solvent extraction methods

- Extraction of organic bases and acids utilising their ionised and un-ionised forms
- Partitioning between organic solvents
- Ion pair extraction

Derivatisation prior to extraction

Supercritical fluid extraction

Solid phase extraction (SPE)

Keypoints

Introduction

Methodology

Types of adsorbants used in SPE

- Lipophilic silica gels
- Typical extraction methodologies using lipophilic silica gels

Polar surface modified silica gels

Typical methodologies using straight-phase adsorbants

Anion exchangers based on surface-modified silica gels

Cation exchangers based on surface-modified silica gels

Factors requiring attention in SPE with silica gels

Borate gels

Immunoaffinity gels

Adaptation of SPE for automated online extraction prior to HPLC analysis

KEYPOINTS

Principles of extraction

The analyte is removed from materials in a formulation matrix which would interfere in its analysis using a solvent in which it is highly soluble but the matrix interferants have limited solubility. Further solvent partitioning steps may then be used in order to reduce the interferants.

Applications

- Most analyses of pharmaceuticals require an extraction step or extractions steps and optimisation of these processes has an important bearing on the precision and accuracy of the analysis
- Widely used in bioanalytical measurements and for concentrating trace amounts of analyte.

Strengths

- A simple and cheap method of removing interferants.

Limitations

- Limited selectivity, limited choice of partitioning solvents, large volumes of solvent required. (See SPE keypoints.)

Introduction

Complex extraction and derivatisation methods are most often applied to bioanalytical procedures and to the concentration of trace impurities in pharmaceuticals rather than to straightforward quality control of active ingredients in pharmaceuticals. Quality control of the active ingredient in a formulation generally utilises a simple extraction procedure and if there is a problem of interference from excipients following extraction, chromatography is able to resolve the active ingredient from the interferants and permit quantitation. However, there are circumstances where low dosage formulations and advanced drug delivery formulations may require more detailed sample handling.

Commonly used excipients in formulations

The principal reason for conducting extraction prior to analysis is in order to remove materials which might interfere in the analysis. This is a greater requirement if chromatographic separation is not carried out during the analysis. Some non-chromatographic techniques such as NIRA aim to avoid all sample preparation through using advanced computing techniques to screen out interference. Even when chromatographic separation is used, extraction of some type has to be carried out prior to analysis in order to remove insoluble tablet matrix materials or oily excipients in creams and ointments. When low levels of drugs are being monitored in biological fluids, extraction procedures may have to be quite detailed in order to remove interference by endogenous compounds. The major types of interferants in formulations are briefly considered in this chapter.

Tablets and capsules

Tablets and capsules usually consist largely of a filler except for high dose formulations, such as paracetamol tablets and tablets of other non-steroidal anti-inflammatory drugs, where the active ingredient may compose a large part of the formulation. The most commonly used filler in tablets is lactose and other popular fillers include other sugars or sugar polymers such as cellulose, starch and mannitol. These substances are polar and will dissolve or swell best in water, thus extraction procedures where the drug is water soluble are best carried out in aqueous media so that the drug is efficiently recovered from the sample matrix. The fillers themselves do not absorb UV light so they are not likely to interfere directly in HPLC procedures where for instance in commonly used reversed-phase chromatography procedures they will elute at the void volume with little perturbation of the chromatographic baseline. Similarly, they produce little interference in direct analyses by UV spectrophotometry. If the drug is not completely water soluble, methanol or ethanol may be used for extraction since they will wet the tablet powder quite well and will dissolve many organic molecules.

Lubricants are used in tablet preparation and include magnesium stearate, stearic acid and polyethylene glycol. They only comprise at most 1–2% of the tablet bulk so that their potential to interfere is slight, particularly since their chromophores are weak. The fatty acid lubricants can often be observed if analysis of a tablet extract is carried out by GC–FID. Tablet coatings are often based on modified sugar polymers such as hydroxypropylmethylcellulose. These coatings are used at about 3% of the tablet bulk, are water soluble and do not absorb UV light.

Colourants obviously have the potential to interfere in analysis because they are efficient absorbers of UV/visible radiation. In tablets and capsules, colours tend to be organometallic dyes or metal oxides which are not appreciably soluble in any of the solvents used for extraction and can be filtered off with other insoluble matrix constituents. When capsules are analysed the coloured outer shell is removed before the contents of the capsule is extracted.

Suspensions and solutions

In suspensions and solutions, the dyes used are water soluble and include natural pigments such as chlorophylls, carotenoids and anthocyanins, and coal tar-based dyes. More effort may be required to remove interference by these materials. Solid phase extraction with ion exchange resins may be useful for removing anionic or cationic dyes, although simple extraction of the drug into organic solvent of moderate polarity may leave such dyes in the aqueous phase. Solutions tend to contain anti-microbial preservatives and anti-oxidants. These are usually either phenols or quaternary amines such as benzalkonium chloride and have strong enough chromophores to interfere in the analysis of a drug. These compounds have to be removed prior to analysis by extraction procedures. Suspensions also contain surfactant materials such as the polyethylene glycol-based detergents but these compounds do not have appreciable UV absorbance and thus have little potential for interference.

Creams and ointments

Sodium and potassium salts of fatty acids, cationic surfactants and non-ionic surfactants are used in creams and ointments. As discussed above these compounds do not have strong chromophores but, particularly the fatty acids, may interfere in chromatography for instance by contaminating reverse-phase HPLC columns if they are not removed. Contamination of reverse-phase HPLC columns by lipophilic materials can often be observed through a loss of chromatographic peak shape. Creams and ointments contain large amounts of oily triglycerides which have to be removed to avoid interference with the chromatographic process. Extraction of the cream with methanol can partly remove this type of interference, partitioning of the extract between hexane and methanol or methanol water mixtures may also be used, the highly lipophilic material is removed into the hexane layer.

Solvent extraction methods

Solvent extraction procedures provide simple methods for separating the analyte from excipients in formulations. The analytical method applied to the isolated analyte can be for example either gravimetric, volumetric, spectrophotometric or chromatographic. In most cases in the pharmaceutical industry chromatographic methods are preferred. The extraction method adopted is governed by the need to remove excipients and by the properties of the analyte.

Extraction of organic bases and acids utilising their ionised and un-ionised forms

Salts of organic bases such as sulphates and hydrochlorides are often highly water soluble and the free bases are usually quite organosoluble, particularly in relatively

polar solvents such as chloroform or mixtures of chloroform and ethanol. Similarly the sodium or potassium salts of organic acids are freely water soluble while the un-ionised acids are usually quite organosoluble. These properties can be used to advantage in designing an extraction procedure. A flow diagram for the extraction steps which can be used for the separation of an organic base from a formulation is shown in Figure 15.1.

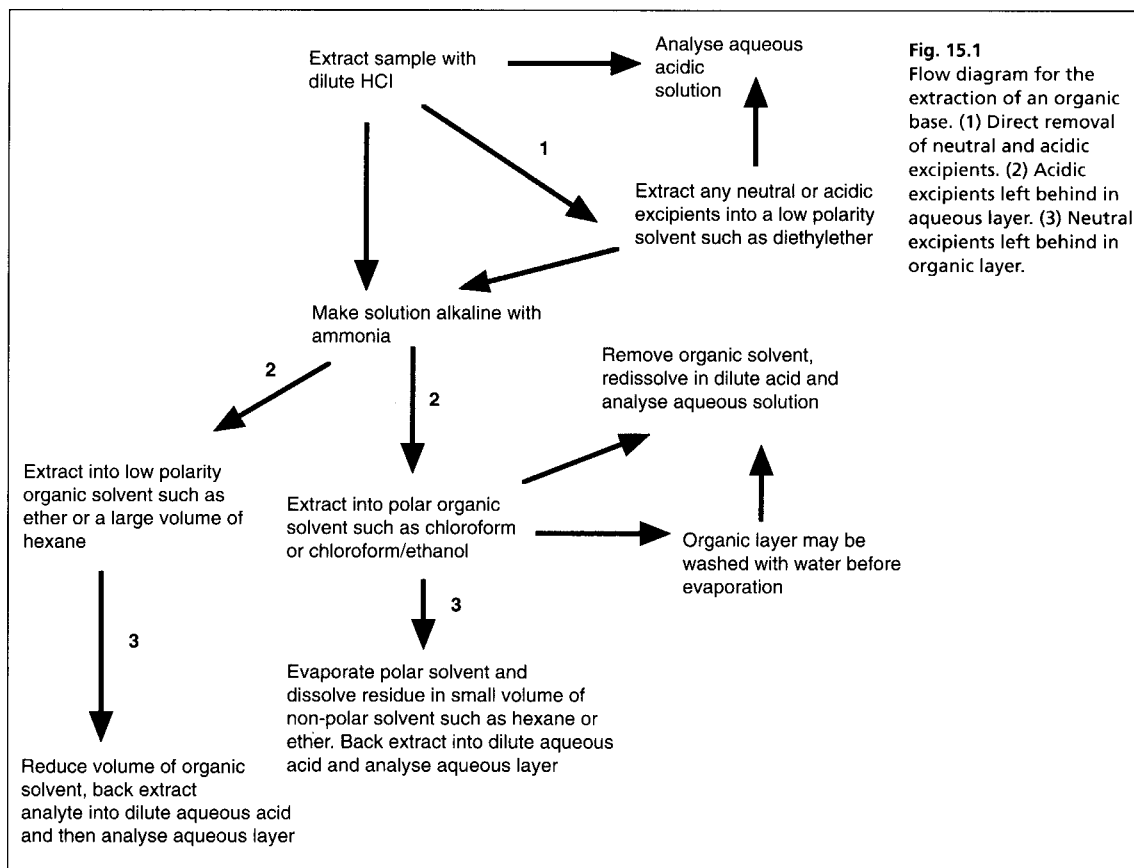

This type of extraction is employed in the BP assay of Cyclizine Lactate Injection: the injection is diluted with dilute H_2SO_4 and then neutral and acidic excipients are extracted with ether. The solution is basified and the cyclizine is extracted into ether leaving the lactate ion, which would not have extracted during the initial ether extraction step, behind in the aqueous layer. For convenience in measurement by UV spectrophotometry and in order to carry out volumetric dilution of the extract, cyclizine is then back extracted into dilute H_2SO_4 and subjected to further dilution.

The same principles apply to the extraction of an organic acid except that in this case high pH values are used to ensure the acid remains in the aqueous layer and low pH values are used to ensure that it is extracted into the organic layer.

Partitioning between organic solvents

Partitioning between organic solvents is used in the extraction of analytes from oily excipients such as in the extraction of steroid creams prior to HPLC analysis. The

most commonly used systems are methanol/hexane, aqueous ethanol/hexane or acetonitrile/hexane. In the case of analysis of corticosteroids in creams, the cream is usually dispersed by heating in hexane and then extracted with an equal volume of methanol. Methanol and hexane mix only very slightly and the oily excipients remain in the predominantly hexane layer, while the more polar corticosteroid partitions into the methanol layer. Use of an internal standard with a structure closely related to that of the analyte is essential in order to achieve good precision in this type of analysis through compensating for incomplete recovery of the analyte. Examples of pharmacopoeial methods using this type of partitioning include assays of: hydrocortisone acetate cream, fluocinolone cream and beclomethasone cream.

Ion pair extraction

Ion pair extraction provides a standard method for estimating ionic surfactants either colorometrically or titrimetrically. For example a cationic surfactant such as cetrimide can be estimated by pairing it with a lipophilic anionic dye such as bromocresol purple. The ion pairing creates a coloured lipophilic ion pair, which can be extracted into an organic solvent such as chloroform and a quantitative measurement of the colour extracted can be made spectrophotometrically. This type of assay is described in the BP for Clonidine Injection and Benzhexol Tablets.

Ion pair extraction has also been used to extract polar analytes in bioanalytical procedures. Figure 15.2 exemplifies the determination of the amino acid taurine by gas chromatography–mass spectrometry (GC–MS); this figure also illustrates a useful property of amines (and phenols), which is that they will react more rapidly than water with an acylating reagent in an aqueous environment thus improving their organosolubility. After acylation and ion pair extraction with tetrabutyl ammonium sulphate the taurine is converted to an amide prior to analysis by GC–MS.

Fig. 15.2
Extraction and
derivatisation of taurine.

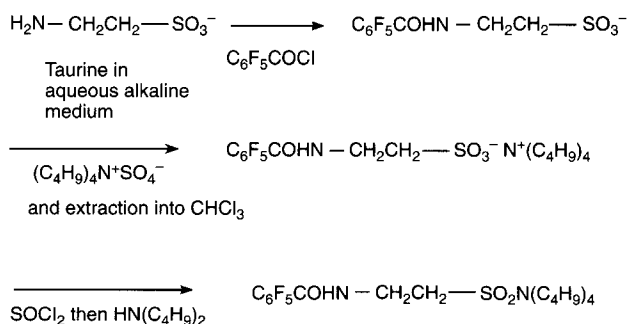

Derivatisation prior to extraction

Figure 15.3 shows aqueous phase acylation of adrenaline in an injection with acetic anhydride. The reaction is carried out in the presence of aqueous sodium bicarbonate and is used in a gravimetric determination of (–) adrenaline in Adrenaline Injection BP.

Supercritical fluid extraction

Figure 15.4 shows a schematic diagram of a supercritical fluid extraction apparatus. The advantages of supercritical fluid extraction (SFE) are as follows:

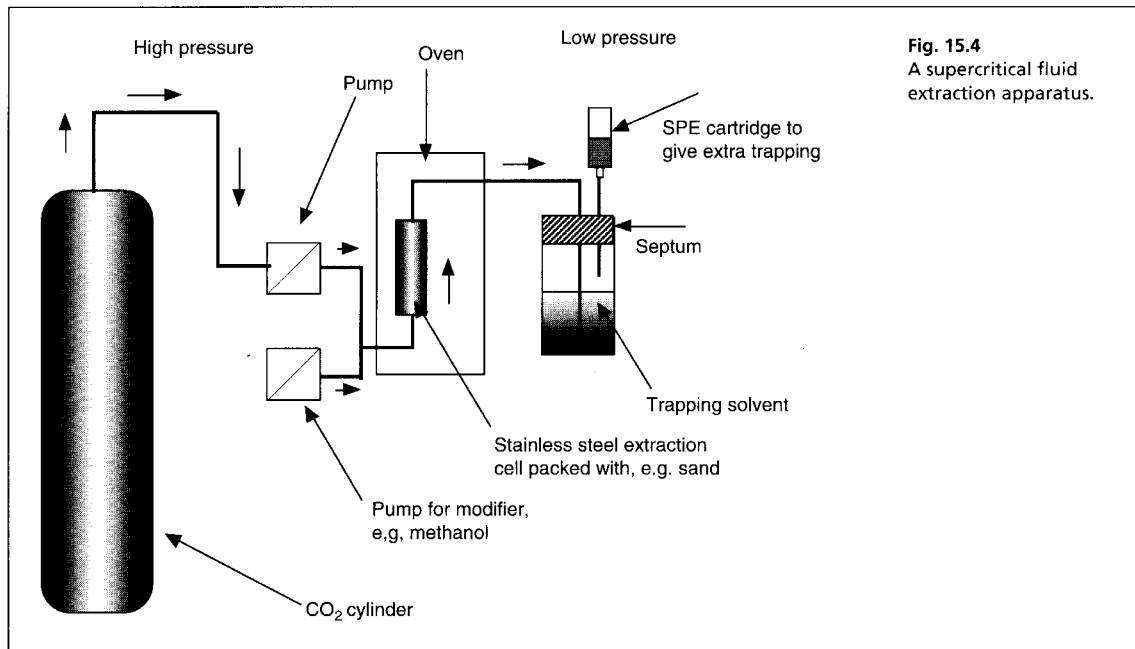
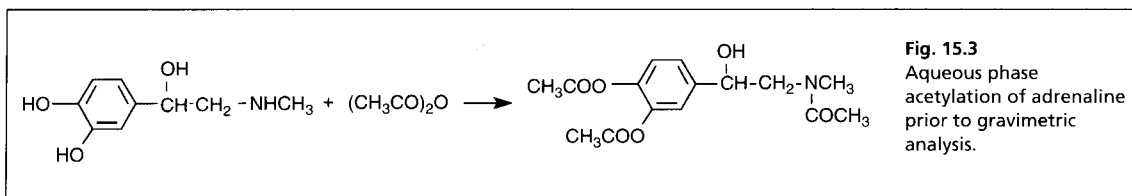

- (i) The solvents are used above their critical temperature and pressure but they function almost as effectively as liquid solvents and have the advantage that mass transfer between sample and solvent, i.e. the rate of extraction, is very fast.
- (ii) The solvent strength of supercritical fluids can be increased or decreased by varying the pressure in the extraction vessel thus providing a simple means of producing selective extraction.
- (iii) CO₂, which is frequently used as an extraction medium, is a non-toxic, non-flammable solvent which is readily disposed of and its low critical temperature (31.1°C) means that it can be used as an effective solvent for extracting unstable compounds.

The most efficient method of conducting SFE is via the dynamic process illustrated in Figure 15.4. This process enables the addition of a polar modifier such as methanol, which increases the solvent strength of the non-polar CO₂. The liquid CO₂ with about 5% v/v of modifier is passed through a stainless steel cell containing the sample, which may be mixed with inert material so that the sample occupies the whole cell volume. Two recent examples of the utilisation of SFE in the analysis of pharmaceuticals are discussed as follows.

Vitamin A, vitamin E and their acetate and palmitate esters were determined in tablets.¹ The tablet powder was mixed with sand and loaded into the extraction vessel; CO₂ alone was used for extraction at 40°C for 15 min. The CO₂ was vented to

atmosphere after being passed into a vial containing tetrahydrofuran at 0°C to trap the analytes. The process was found to give good recovery and was more selective for the analytes than an established liquid/liquid extraction process. The sample was analysed by HPLC.

An unstable analogue of prostaglandin, PGE₁ formulated in a polybutadiene polymeric matrix, was placed in a SFE cell and extracted with CO₂/formic acid (95:5) at 75°C.² Extraction was continued for 60 min and then the extract was collected in hexane/ethanol (2:1) at 0°C. The advantages of the SFE method were that the solvent effected simultaneous cleavage of the polymer–prostaglandin bond without instability problems and with improved mass transfer enabling good recovery from the polymer matrix.

Solid phase extraction (SPE)

KEYPOINTS

Principles

The analyte is dead stopped on the SPE medium by loading it onto the cartridge in a solvent of low eluting power. It may then be washed with other solvents of low eluting power and is then finally eluted with a small volume of a strong solvent.

Applications

- Particularly useful for selective separation of interferants from analytes, which is not readily achievable by liquid/liquid extraction
- Widely used in bioanalytical measurements and environmental monitoring for concentrating trace amounts of analyte.

Advantages in comparison with liquid/liquid extraction

Solid phase extraction

- The solid phase is immiscible with solvents and thus after loading the sample a range of washing conditions can be used to remove interferants through having a wide choice of washing solvents
- Chemical nature of adsorbant can be varied so that it is selective for a particular functional group in the analyte
- Emulsions are not formed between the two phases
- A sample in a large volume of solution can be trapped on the column (dead stopped) and thus concentrated
- Only small volumes of solvent are required both for washing and elution
- Extraction can be carried out in batches rather than serially
- The expense of the columns can be offset against savings in solvent purchase and disposal.

Liquid/liquid extraction

- Solvents must be immiscible, hence there is a limited choice of extraction and washing solvents
- Emulsions may form
- Large solvent volumes are required when extraction of large sample volumes is carried out
- The extract may have to be concentrated prior to analysis and then back extracted into an aqueous phase
- Extractions have to be conducted serially.

Limitations

- Although recoveries are generally good, it is probably best to use an internal standard in this type of analysis to compensate for any possibility of irreversible absorption onto the extraction medium
- Silica gel-based SPE columns are unstable to strongly alkaline conditions.

Introduction

SPE is increasingly being adopted as a useful method of sample preparation where extraction into an organic solvent would have originally been employed. The reasons for this are outlined in the Keypoints box. The technique has been employed more extensively in the 'clean up' of biological samples prior to analysis but there are increasingly useful examples of its application to the analysis of drugs in formulations.

Methodology

Typically solid phase extraction is based on the type of system shown in Figure 15.5. The volume of sample which can be loaded onto this small column can be increased using a column with a larger sample reservoir. The sample is usually aspirated through the column under vacuum.

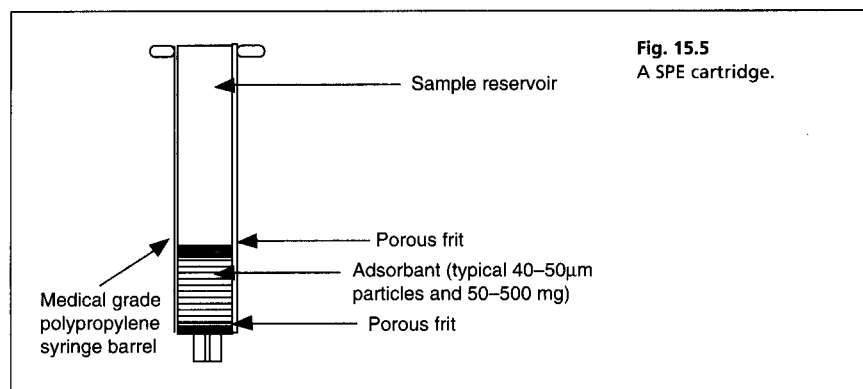

The steps involved in a SPE procedure are shown in Figure 15.6:

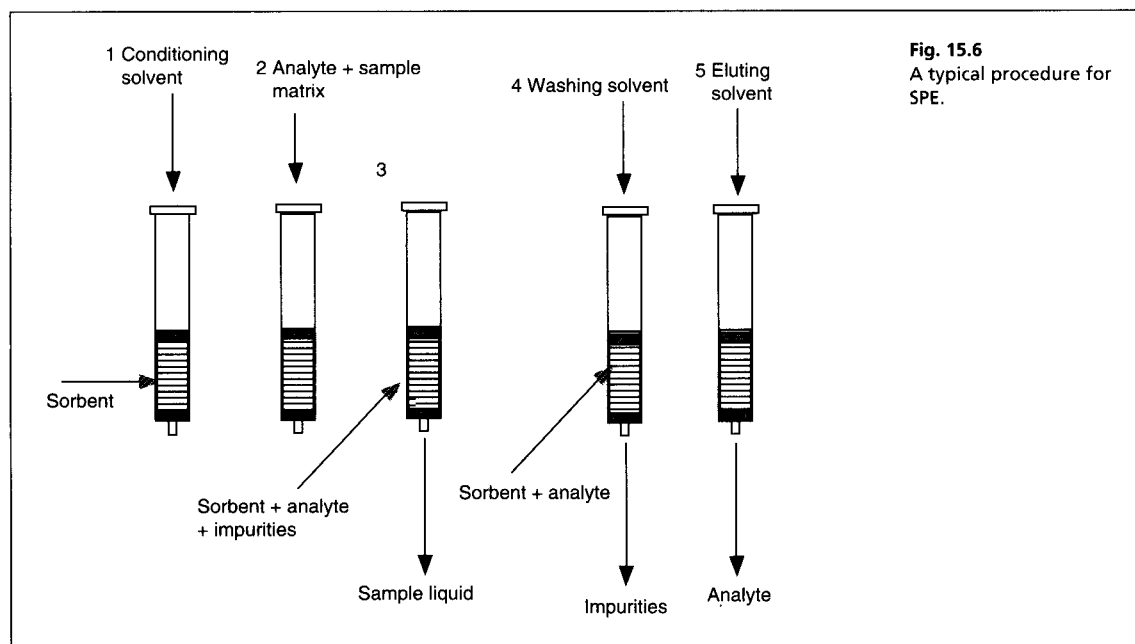

- (i) The column is washed with 5–10 bed volumes of the solvent, which will be used to elute the analyte and if an ion exchange adsorbant is to be used, 5–10 volumes of an appropriate buffer.
- (ii) The analyte is loaded onto the column in an appropriate solvent, which is too weak to elute it from the column.
- (iii) The sample solvent passes through the column leaving the analyte + impurities adsorbed on the stationary phase.
- (iv) The column is washed with solvent, which will elute impurities while leaving the analyte on column. This requires a good understanding of the physico-chemical properties of the analyte and the adsorbant.
- (v) The analyte is eluted with an appropriate solvent, preferably one which will leave further interferants behind on the column.

A vacuum manifold can be used for conducting multiple extractions simultaneously as shown in Figure 15.7.

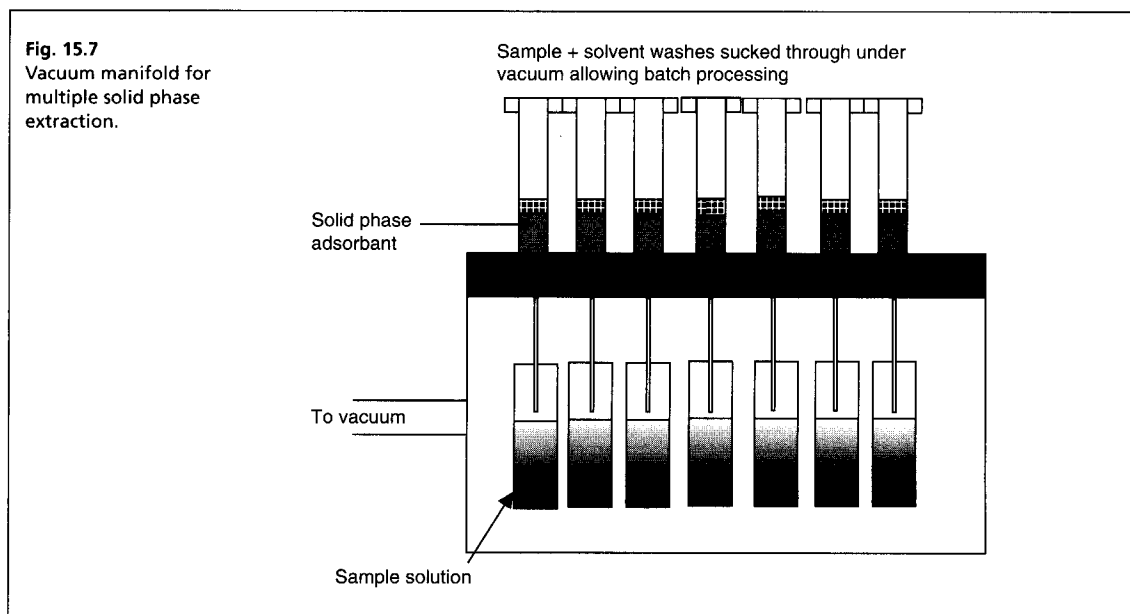

Types of adsorbants used in SPE

Lipophilic silica gels

The lipophilic silica gels shown in Figure 15.8 will retain lipophilic compounds, provided they are in an un-ionised state, through van der Waals interactions and in the case of amines, through some degree of polar interaction. These phases are generally not completely endcapped so that there are free polar silanol groups remaining on the surface.

In the case of amines the type of interaction shown in Figure 15.9 may occur. The shorter the alkyl chain length on the silica gel surface the more likely it is that adsorption also plays a part in the extraction. It is possible to buy highly endcapped reverse-phase silica gels where most of the residual silanols have been blocked but it may be better to take advantage of the mixed lipophilic and adsorptive properties of reverse phases which have not been endcapped.

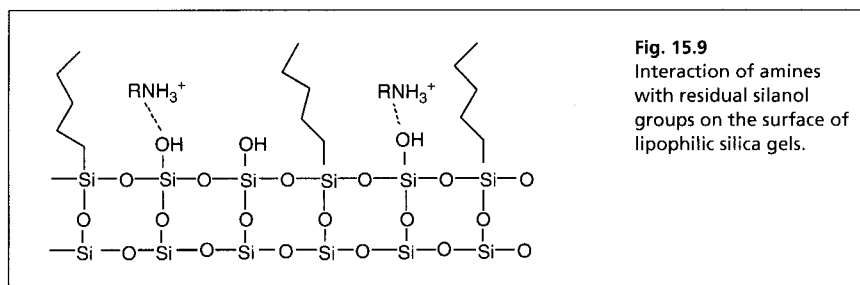
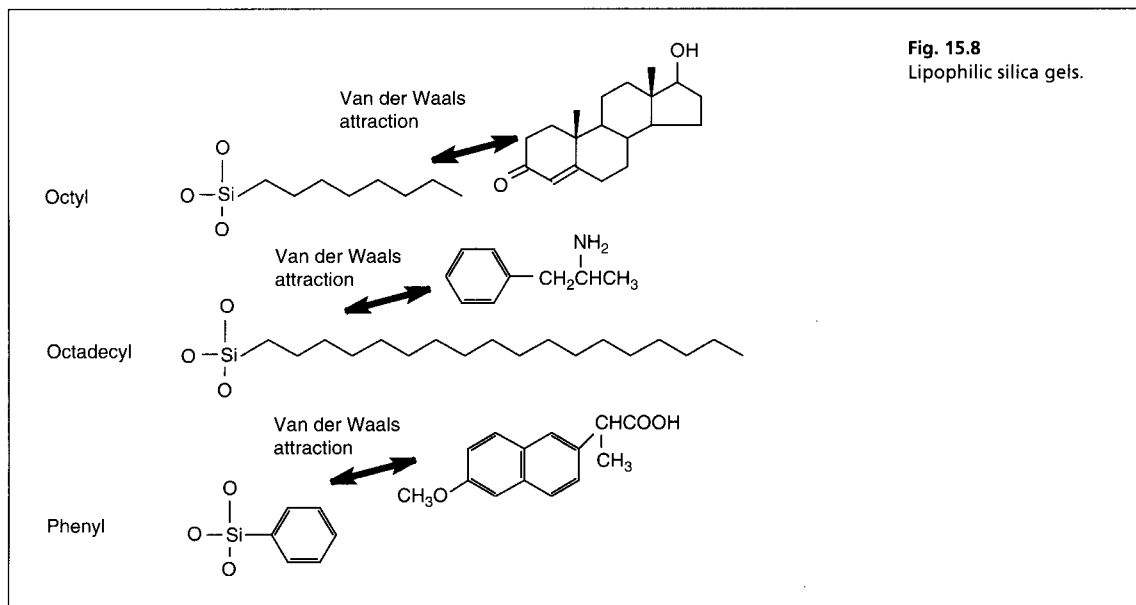

Recently high purity styrene divinylbenzene polymeric gels have become available for use in lipophilic SPE extraction; these types of materials formerly contained monomer materials which could interfere in analyses. These types of gels are much more lipophilic than surface-modified silica gels and also have a higher capacity for sample loading. Their applications are similar to those of the lipophilic silica gels.

Typical extraction methodologies using lipophilic silica gels

Typically the columns are conditioned by washing with 5–10 bed-volumes of methanol followed by a 5–10 bed-volume of water or a suitable buffer.

Basic compounds are adsorbed from aqueous solution by adjusting to alkaline pH with buffer, e.g. a buffer of pH 10 would be suitable for most bases. The column can be washed with further aliquots of alkaline buffer, water or if the compound is highly lipophilic, mixtures of methanol and alkaline buffer can be carried out. The compound is finally eluted with either an acidic buffer or with an organic solvent such as methanol or ethanol. An example of an extraction of an amine using a lipophilic silica gel is shown in Box 15.1.

Acidic compounds are extracted from aqueous solution by adjusting to acidic pH. The column can be washed with dilute acid, water and if the compound is highly

Box 15.1 Typical example of extraction by reverse-phase SPE

An oral suspension of chlorpromazine has the following composition and must be extracted so that excipients are removed prior to analysis by UV spectrophotometry: Chlorpromazine 0.025% w/v, parahydroxybenzoic acid methyl ester 0.1% w/v, neutral water soluble dye, lipophilic flavouring agent, sodium lactate buffer.

- (i) 5 ml of solution is mixed with 5 ml of 0.5 M ammonia buffer pH 9.5 and the sample is passed through an octadecyl silane (ODS) SPE cartridge. The cartridge is washed with a further 5 ml of ammonia buffer. At this stage the chlorpromazine is in its free base form and has adsorbed onto the lipophilic ODS and the lactate, the dye and the preservative (which are all water soluble, particularly at high pH), have passed through the column.
- (ii) The sample is eluted with 5 ml of 0.5 M phosphate buffer pH 2.0/methanol (95:5) and made up to the volume required for analysis by UV spectrophotometry. These conditions elute the basic chlorpromazine and leave behind any neutral lipophilic compounds, e.g. flavouring on the column.

lipophilic, mixtures of methanol and dilute acid. The compound can be eluted with methanol, acetonitrile, tetrahydrofuron (THF) or alkaline buffer.

Neutral compounds can be extracted without controlling pH. Washing can be carried out with dilute acid or alkaline buffer (to remove ionisable impurities) and methanol water mixtures. The compounds can be eluted from the column with methanol, ethanol or chloroform.

Polar surface-modified silica gels

These silica gels retain analytes through interaction between polar groups; silica gel itself or the surface-modified polar silica gels shown in Figure 15.10 may be used.

Fig. 15.10
Silica gel and polar surface-modified silica gels.

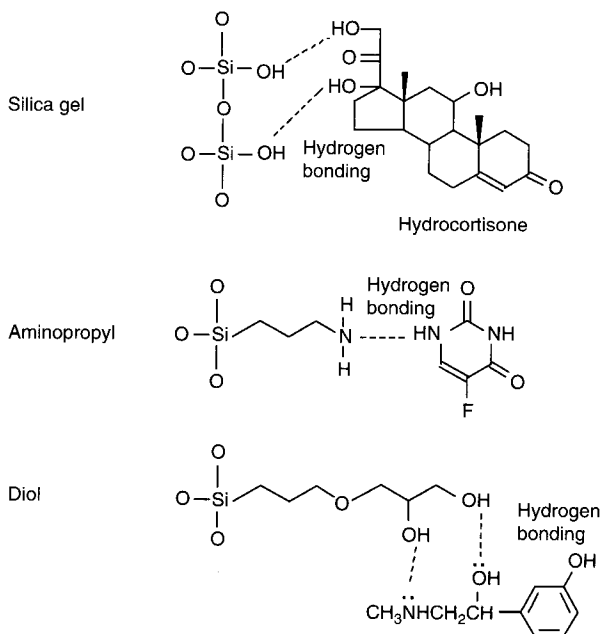

Typical methodologies using straight-phase adsorbants

These adsorbants are typically used for polar compounds that are not well retained by reverse-phase adsorbants. The columns are conditioned by washing with 5–10 bed-volumes of the solvent which will be used to elute the analyte. The sample is loaded onto the column in a solvent, which is not sufficiently strong to elute it.

Washing of the column is often carried out with a moderate polarity organic solvent, e.g. alcohol-free methylene chloride. Polar compounds are then eluted with methanol or mixtures of methanol and acidic buffer (for basic compounds) or methanol and alkaline buffer (for acidic compounds). Diol columns have been used to good effect in the extraction of polar drugs from pharmaceutical creams.^{3,4}

Anion exchangers based on surface-modified silica gels

Ion exchangers based on polymeric resins have been in use for many years. Silica gels coated with ion exchanging groups are a relatively recent innovation. They have the advantage that they have less organosorptive properties than the polymeric resins and thus do not require as high an organic component in the eluting solvent to remove organic compounds after adsorption. Typically the anion exchanger is conditioned by washing with 0.01–0.1 M buffer at the pH of the sample solution. The buffer should contain ions which are relatively easy to displace such as OH⁻, C₂H₅COO⁻, CH₃COO⁻, or F⁻. Ions such as Cl⁻, Br⁻, NO₃⁻, HSO₄⁻ or citrate are not readily displaced. The acidic sample is then applied in a buffer (0.1 M) one or two pH units above its pK_a value, e.g. for methicillin shown in Figure 15.11, a buffer pH 3.8–4.8 would be used. Methicillin can be extracted with either a strong or a weak cation exchanger since it is a relatively strong acid. The adsorbant can then be washed with further amounts of the buffer, with deionised water or with organic solvent. The sample can then be eluted with a buffer containing a counter ion at a high concentration, e.g. for methicillin 1 M sodium chloride (NaCl) or 1 M sodium citrate. Many organic compounds are likely to have a high affinity for the lipophilic surface of the SPE medium and methanol might be included in the elution buffer. Compounds can also be eluted by ionisation suppression, thus methicillin could be eluted at low pH, e.g. with 1 M hydrochloric acid/methanol, but this would not be advisable in this example because of the instability of penicillins at low pH.

Cation exchangers based on surface-modified silica gels

The cation exchange column is conditioned by washing with a 0.01–0.1 M buffer at the pH of the sample solution. The buffer should contain K⁺, Na⁺ or NH₄⁺ ions which are readily displaced from the gel by organic cations; divalent ions such as Ca²⁺ or Mg²⁺ are difficult to displace from the gel. The sample is then applied in a buffer (0.1 M) one or two pH units below its pK_a value, e.g. for the extraction of adrenaline (Fig. 15.11) ammonium chloride (NH₄Cl) buffer pH 8.3 might be used. The adsorbant can then be washed with further amounts of the buffer, with deionised water or with an organic solvent such as methanol. Elution is then carried out with a buffer containing a counter ion at a high concentration, e.g. 1 M ammonium chloride buffer. If the sample has limited aqueous solubility a solvent such as methanol or ethanol can be included in the high ionic strength buffer. An alternative to elution at high ionic strength would be suppression of the ionisation of the amine group by elution with methanolic ammonia; however, in this case the time of exposure of the

readily oxidised catechol group to high pH conditions should be minimised. This type of elution is useful if GC or GC-MS analysis is to be carried out because the analyte is eluted in a salt-free solution.

Fig. 15.11
Silica gel-based ion exchange SPE media.

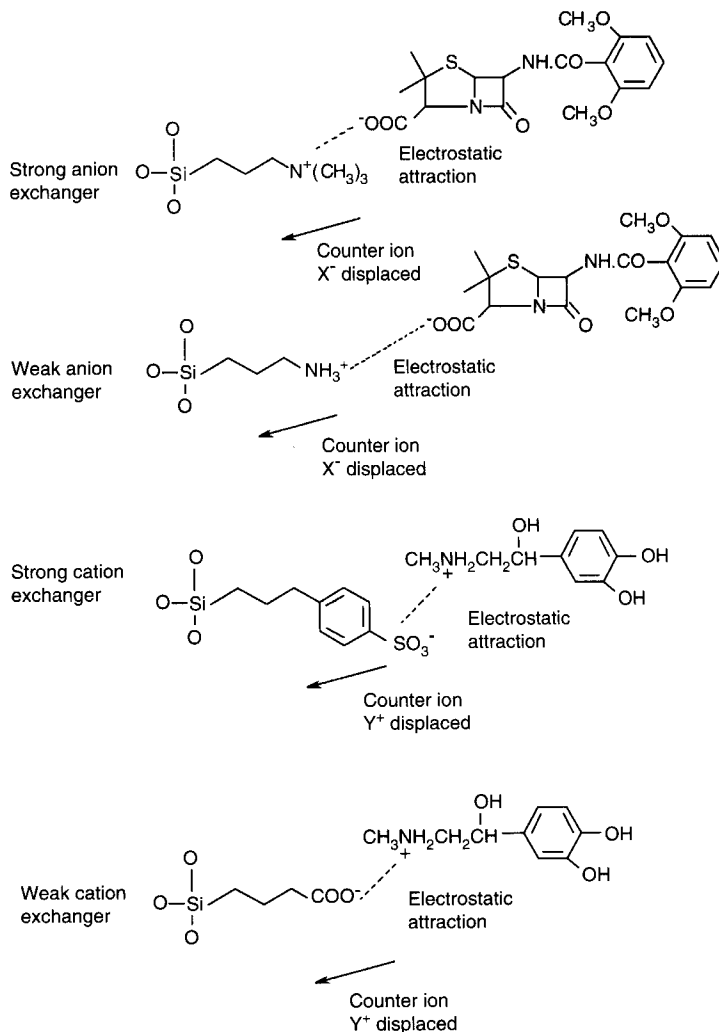

Factors requiring attention in SPE with silica gels

- Too fast a flow rate does not allow sufficient time for equilibration between the extraction medium and the solvent flowing through it, e.g. the solvent may track through the matrix without contacting the whole surface.
- The capacity of sorbent gels is 1–5% of their mass, e.g. for a 100 mg cartridge 1–5 mg.
- Non-selective gels may have reduced sample capacity for dirty sample matrices, e.g. if a small amount of octadecyl gel is used to extract a sample from a matrix containing large amounts of lipophilic materials, the gel capacity may be exceeded.

- (iv) Attention must be paid to the control of the pH of the sample and washing solutions.
- (v) A careful choice of washing solvents can produce extensive sample 'clean up'.
- (vi) The elution solvent must overcome both the primary interactions of the analyte with the bonded phase and any secondary interactions with silanol groups.
- (vii) The amount of fines (fine particles of silica gel) generated by different manufacturers' cartridges varies. Ideally very little fines should elute from the column with the sample. Fine particles of silica gel can damage HPLC systems and interfere in derivatisation reactions used prior to analysis by GC.

Borate gels (Fig. 15.12)

These gels are based on immobilised alkyl boronic acids. They have a selective affinity for 1,2- or 1,3-diol groupings such as those found in catechol-containing molecules such as dopamine and in sugars or glycosides.

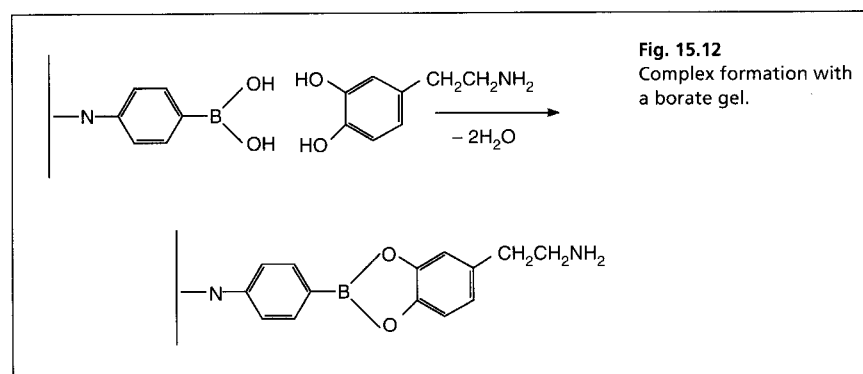

The analyte is loaded onto the gel in a buffer at *ca* pH 7.0 and the complex formed can then be broken down using a mildly acidic eluent such as 0.1 M acetic acid. This type of extraction has been applied to the determination of dopamine, adrenaline and noradrenaline in plasma and to the determination of the extent of reaction of glucose with serum albumin as a measure of glucose fluctuations with time in diabetics.

Immunoaffinity gels

These adsorbants are based on immobilised ligands, which have a high affinity for a particular analyte (Fig. 15.13). There are examples where antibodies have been raised to an analyte and then bound to the surface of a SPE matrix. Various types of chemistry permit this type of immobilisation and affinity chromatography is well established in biochemistry. With the proliferation with biotechnological products such as therapeutic peptides, the use of these types of columns for extraction may increase since they can be designed to be highly selective for such compounds.

An example of a highly specific affinity adsorbant of this type is where a monoclonal antibody to a particular compound is immobilised as shown in Figure 15.14. For instance, a gel with a monoclonal antibody to β -interferon attached has been used in industrial scale extraction of the compound from fermentation mixtures.

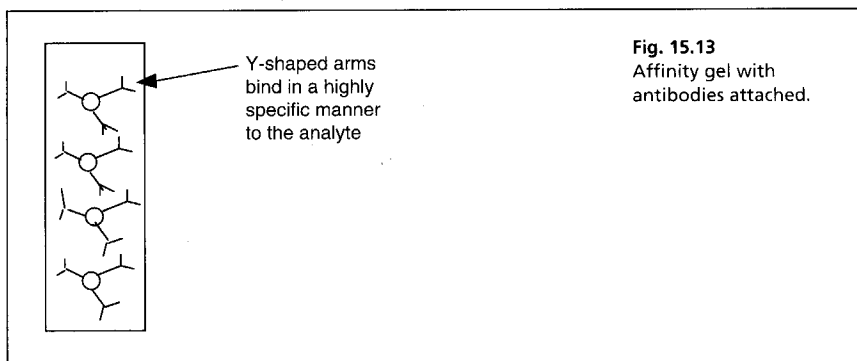

In most examples in the literature, polyclonal antibodies are used for preparing such columns but the increasing availability of monoclonal antibodies (MAbs) should lead to affinity gels based on MAbs becoming available. Such specificity would be particularly valuable where peptide drugs have to be selectively extracted from biological matrices prior to analysis.

Adaptation of SPE for automated online extraction prior to HPLC analysis

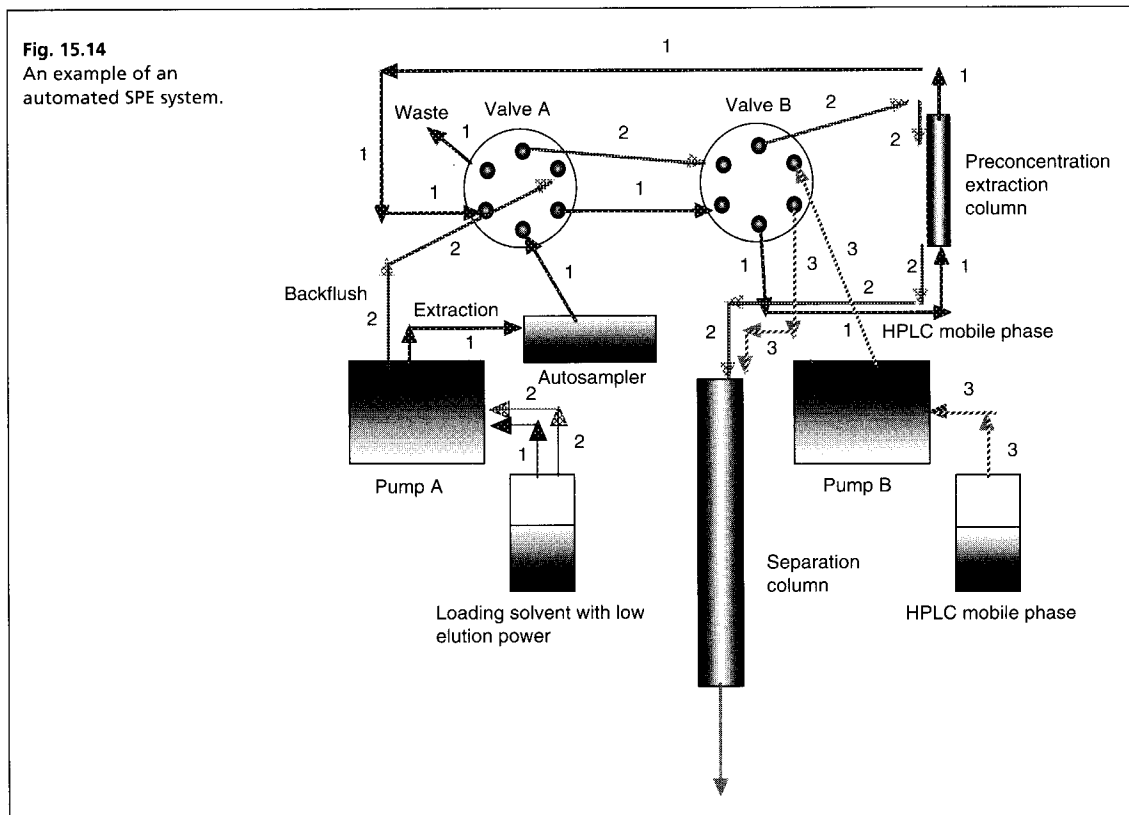

Automated extraction can be carried out as illustrated in Figure 15.14. The basics of the system are as follows:

- (i) A solvent of low strength loads the sample so that it is trapped at the head of an extraction column. This column could be non-polar if removal of polar impurities is required before chromatography or polar if removal of lipophilic materials is required.
- (ii) The sample is back flushed with the same solvent which was used in loading it onto the extraction column and is trapped at the head of the chromatography column.
- (iii) The sample is eluted with the HPLC mobile phase, e.g. a method was developed for the analysis of macrolide antibiotics.⁵ Extraction was carried out by flushing it onto a cyanopropyl cartridge with phosphate buffer pH 10.5/acetonitrile (90:10). The sample was then backflushed with the same solvent onto an ODS analytical column and then eluted with phosphate buffer pH 7/acetonitrile (46:54).

References

1. S. Scalia, G. Ruberto and F. Bonina. *J. Pharm. Sci.* 84, 433–436 (1995).
2. D.A. Royston, J.J. Sun, P.W. Collins, W.E. Perkins and J.J. Tremont. *J. Pharm. Biomed. Anal.* 13, 1513–1520 (1995).
3. A.M. Di Pietra, V. Cavrini, V. Andrisano and R. Gatti. *J. Pharm. Biomed. Anal.* 10, 873 (1992).
4. D. Bonazzi, V. Andrisano, R. Gatti and V. Cavrini. *J. Pharm. Biomed. Anal.* 13, 1321–1329 (1995).
5. M. Hedemo and B-M. Eriksson. *J. Chromatogr. Biomed. Apps.* 692, 161–166 (1995).

Further reading

Solid-Phase Extraction Principles and Practice. E.M. Thurman and M.S. Mills. Wiley Interscience, Chichester (1998).

Index

- Accuracy and precision, 2–6
- ACE inhibitors, HPTLC, 291
- Acebutalol, physico-chemical properties, 43
- Acetic acid
 ionisation, 20–1
 protonation, 57
- Acetic anhydride, estimation of alcohols, 55–6
- Acid–base titrations, 51–8
 direct aqueous, 51–4
 indirect aqueous, 54–6
 non-aqueous, 56–8
- Acids and bases
 Henderson–Hasselbalch equation, 20, 24, 29–30
 pH determination, 18–20
 salt hydrolysis, 25–6
 strength and pK_a, 20, 22–3
 weak, non-aqueous titration, 57–8
- Aclofenac, CE, 302–3
- Activity coefficient, defined, 27
- Adrenaline
 conversion into fluorescent derivatives, 139
 derivatisation prior to extraction, 317–18
 fluorescence, 136
 iron II complex, 89
 in lignocaine injection
 ion pair chromatographic assay, 264–5
 UV/visible spectrophotometric assay, 89–90
 R and S enantiomers, 33
 in urine, ion exchange chromatography, 269–70
- Adrenocorticotrophic hormone, separation by CE, 304–5
- Adsorbants
 immunoaffinity gels, 326
 solid phase extraction, 321–2, 324
- Adsorbents, thin layer chromatography, 283–5
- Affinity gels, 326–7
- Alcohol groups
 IR absorption, 105
 neutral, 44
- Alcohols
 estimation with acetic anhydride, 55–6
see also Named examples
- Almond oil, composition, and GC analysis, 216–17
- Aluminium, determination, 138
- Amide groups, 40
 IR absorption, 105
 neutral, 43
- Amine groups
 aromatic, 43
 conversion into fluorescent derivatives, 139
 IR absorption, 105
 secondary, 43, 44
 tertiary, 39, 45
- Aminopropyl column, 269
- Amitriptyline, structure and pK_a, 311
- Ammonia, ionisation, 20–1
- Ammonium pyrrolidinedithiocarbamate, 129
- Ampicillin
 NIRA, 117
 solvent residues, GC 231–3
 UV/visible spectrophotometric assay, 88–9
- Analytical blank, defined, 11
- Analytical methods
 chemical analysis *see* Titrimetric and chemical analysis
 extraction methods, 313–28
 quality control, 1–15
 accuracy and precision, 2–6
 compound random errors, 9–10
 impurities and deviation from formulation, 15
 repeatability and reproducibility, 6–8
 reporting of results, 10–11
 standard operating procedures (SOPs), 8–9
 terminology, 11–14
see also Specific named methods
- Aniline
 NMR spectrum, 150–1
 UV absorption characteristics, 78
- Anion exchangers, surface-modified silica gel, 324
- Anionic interference, AES, 123
- Anticholinergic drugs, 45
- Antidepressants, separation on basis of ionic radius, CE, 301–2, 311
- Antihypertensive drugs, 45
- Apigenin, structure, 310
- Apronal, McLafferty fragment, 180
- Aprotinin, qualitative TLC, 286
- Aqueous acid–base titrations, 51–6
- Argentimetric titrations, 58
- Aromatic ether group, 43, 105
- Ascorbic acid, ion pair chromatographic assay, 265–6
- Aspirin
 in dextropropoxyphene, difference spectrophotometry, 90–1
 IR absorption, interpretation, 107, 107
 with paracetamol, HPLC, narrow range calibration curve, 256–7
 particle size, NIRA, 113–14
 physico-chemical properties, 41
 potentiometric titration, 66, 67
 pK_a value determination, 67
 proton NMR spectrum, 155–6
 quantitative technique, 163–4
 proton–proton correlation spectrum, 161
- Asymmetry factor (AF), column performance, HPLC, 203
- Atenolol, separation of impurities, CE, 300–1
- Atmospheric pressure (API) ionisation, 187
- Atomic absorption spectrophotometry (AAS), 125–30
 applications, 125, 127–30
 instrumentation, 126–7
 metals, limit tests, 127–9
 principles, 125
 quantitation, 121–3

- Atomic emission spectrophotometry (AES), 119–25
 applications, 119
 assays, method of standard additions, 123–5
 instrumentation, 120–1
 interferences, 123
 principles, 119
- Atropine, eyedrops, quantitative analysis, 226–8
- Attenuated total reflectance, sample preparation for IR spectrophotometry, 103–4
- Automated dissolution testing, flow injection analysis, 73
- Automated online SPE, 327–8
- Automation of wet chemical methods, 68–71
- Beer–Lambert Law, 79
- Benzene
 attached protons, chemical shift values, 150
 UV absorption characteristics, 78
- Benzhexol, ion pair extraction, 317–19
- Benzocaine, NMR spectrum, 158
- Benzoic acid
 pKa value determination, 66–7
 proton shifts, 151
 UV absorption characteristics, 78
- Benzyl alcohol group, neutral, 44
- Benzylpenicillin, physico-chemical properties, 41–2
- Betamethasone
 absorption maximum, 83
 diastereoisomerism, 38–9
 as internal standard, one-point calibration of steroids, HPLC, 260–3
 IR absorption, fingerprint technique, 110–11
 structure and HPLC elution, 242
 UV spectrum, 82
- Bioanalysis, gas chromatography, 233–4
- Biological NMR, 165
- Borate gels, 326
- Bromophenol blue, 53
- Buffers, 23–6
 addition of solvents in HPLC, 246
 Henderson–Hasselbalch equation, 24
 running, CE, 305–7
- Bupivacaine
 association constant, 307
 bioanalysis (GC), 233–4
 EI mass spectrum, 177
 in injection, determination of dimethylaniline, 229–30
 separation by CE, 306–7
 structure and HPLC, 245–6
- Butan-2-ol, EI mass spectrum, 173
- n-Butanol, EI mass spectrum, 173
- Butorphanol tartrate
 APCI MS–MS, 192
 impurities and degradants, ES–MS, 191–3
- ¹³C, radiochemical detector, 224
- ¹³C NMR, 159–61
- Calcium carbonate, in formulations, Raman analysis, 142–3
- Calcium ions, AAS, haemodialysis solutions, 127
- Calcium silicate, silanization, 211–12
- Calibration, defined, 11
- Capillary electrophoresis, 293–311
 applications, 293, 300–11
 control of separation, 299–300
 dispersion, 299–300
 electrodispersion, 300
 ion migration, 296–8, 299
 joule heating, 299
 solute–wall interactions, 300
 instrumentation, 298–9
 micellar electrokinetic chromatography, 307–10
 principles, 293, 294–5
 electro-osmotic flow (EOF), 295–6
 variables affecting EOF, 297
 running buffer, additives, 305–7
- Capillary gas chromatography *see* Gas chromatography
- Captopril
 chirality, 36
 diastereoisomers, 36
 flow injection analysis, 71
 HPTLC, 291
- Carbamate group, 45
- Carbon-14, radiochemical detector, 224
- Carbon-13 NMR, 159–61
 typical chemical shifts of ¹³C atoms, 160
- Carbon–carbon bonds
 energy level of absorption, 100
 IR absorption, 99
 types, 77
- Carbowax, McReynolds' constant, 213
- Carboxylic acids, 41–2
 IR absorption, 105
- Catechol group, 44
- Catecholamines
 urine, ion exchange chromatography, 269–70
see also Adrenaline; *Other specific substances*
- Cation exchangers, surface-modified silica gel, 324–5
- Cefotaxime, and impurities, 308–9
- Cellulose, stationary phase in TLC, 281
- Cephalosporins
 micellar electrokinetic chromatography, 308–9
 solvent residues, GC, head space analysis, 232
- Cetomacrogol-1000, ELSD, 268
- Cetrimide, ion pair chromatography, ascorbic acid, 265–6
- Chiral derivatisation agents, 219–20
- Chiral discrimination, 218–19
 cyclodextrins, 219
- Chiral HPLC
 cyclodextrins, 273
 enantiomers, 270
 ion pairing, 273
 Pirkle phases, 271–2
- Chiral NMR, 165
- Chirality
 diastereoisomers, 36–8
 and optical isomerism, 33–6
- Chirasil Val, structure, 218
- Chloramphenicol, limit tests, TLC, 290
- Chlorocresol, flow injection analysis, 72
- Chloroquine
 EI mass spectrum, 178
 NICI mass spectrum, 178
- Chloroxine, flow injection analysis, 71
- Chlorpheniramine, conversion into fluorescent derivatives, 139
- Chlorpromazine
 fluorescence, 136
 reverse-phase solid phase extraction, 323
- Chromatographic theory, 195–205
 calculation of column efficiency, 196–7
 column performance, parameters used, 201–3
 data acquisition, 203–4
 origins of band broadening in HPLC, 197–201
 report generation, 204–5
 void volume and capacity factor, 195–6
see also Gas – (GC–MS); High-pressure liquid – (HPLC); Thin-layer – (TLC)
- Chromophores
 amino group auxochrome, 84
 extended benzoid, 83
 hydroxyl group auxochrome, 84
 simple benzoid, 83
 UV radiation absorption, 78
- Chrysanthemyl esters, menthol, 219
- Cinnamic acid, UV absorption characteristics, 78
- Clindamycin, potassium permanganate, TLC, 285
- Clobetasol butyrate, absorption maximum, 83
- Clofibrate, NMR spectrum, 158
- Clonidine injection, ion pair extraction, 317–19

- Clotrimazole
 limit tests, TLC, 288
 synthesis, 288
- Cloxacillin, UV/visible spectrophotometric assay, 89
- Codeine
 EI mass spectrum, 175–6
 ionic mobility, 295
 limit tests, TLC, 289
 proton NMR spectrum, quantitative technique, 163–4
 Raman analysis, 142
- Colchicine, solvent residues, GC, 231–3
- Columns
 gas chromatography, 211–12
 HPLC, 196–7, 201–3, 296
- Compleximetric titrations, 58–9
- Corticosteroids, 44
 alkaline tetrazolium blue, 286
 ethanol/sulphuric acid, 286
 one-point calibration against internal standard, HPLC, 260–3
 structural factors governing rate of elution, HPLC, 241–3
- COSEY, proton–proton correlation, 161–3
- Coulometric end-point titration, 68
- Creams and ointments, excipients, 315
- Cresol red, 53
- Cyclizine lactate
 extraction, BP assay, 316
 limit tests, TLC, 288
 UV/visible spectrophotometric assay, 86–8
- Cyclodextrins
 as additives in running buffer, CE, 305–7
 chiral discrimination, 219
 chiral HPLC, 273
 separation of enantiomers, 306–7
- Cyclohexanol
 cleavage/rearrangement, 175
 EI mass spectrum, 175
- Degradation of drug molecules, zero/first order degradation, 31–2
- Derivatisation, HPLC, 270
- Derivative spectra, Gaussian absorption band, 92
- Desipramine, structure and pKa, 311
- Detectors
 gas chromatography, 222–4
 HPLC, 248–52
 limit of detection, 11–12
 refractive index (RI) detector, 250, 268
 selectivity and sensitivity, 13–14
 thin layer chromatography, 285–6
 variable wavelength UV detector, 248
- Dexamethasone
 diastereoisomerism, 38–9
 IR absorption
- DRIFT technique, 108
 fingerprint technique, 110–11
 interpretation, 107
- Dexpanthenol, limit tests, TLC, 288
- Dextromethorphan, single point calibration, HPLC, 257–9
- Dextromethorphan pseudoephedrine, derivative spectrophotometry, 90–1
- Dextropropoxyphene aspirin, difference spectrophotometry, 90–1
- Dialysis solutions
 Ca and Mg by AAS, 127
 K, Na and Ba by AES, 125
- Diastereoisomers, 36–8, 305–6
 temporary complexes, chiral HPLC, 271
- Diatomaceous earth, stationary phase in TLC, 281
- Diazotisation titrations, 64
- Dichloroacetophenone, FT–IR vs FT–Raman spectra 141
- Diclofenac, TLC, 282–3
- Dielectric constant, 27–8
- Diels–Alder molecular fragmentation patterns, 175
- Difference spectrophotometry, 90–1
- Diffuse reflectance, sample preparation for IR spectrophotometry, 102, 103
- Digoxin, dissolution rate of tablets, 138
- Dimethylaniline, determination in bupivacaine injection, 229–30
- Diode array detector (DAD), 249, 250–2
- Diphenhydramine
 NIRA, 117
 structure, 179
- Dipole moment, IR absorption, 99
- Dissociation constant Ka, 18–19
- (-) DOPA
 chirality, 36
 mass spectrum, 179
 non-aqueous titration, 57
 tropylium ion, 179
- Dopamine, in urine, ion exchange chromatography, 269–70
- Doxepin, structure and pKa, 311
- Dragendorff reagent, 285–6
- DRIFT technique
 IR absorption, 108
 Kabela Munk units, 112
- Drug molecules
 activity, 27–8
 multicomponent dosage forms, 114–15
 blend uniformity, NIRA, 114
 half-life, 32
 properties *see* Physico–chemical properties of drug molecules
 release from formulation, 95–6
 solubility, UV/visible spectrophotometry, 95
 stability, 31–2
- Dysprosium, inductively coupled plasma emission spectroscopy, 130–1
- Econazole, internal standard, HPLC, 263–4
- EDTA
 back titrations, 59
 compleximetric titrations, 58–9
- Electro–osmotic flow (EOF), capillary electrophoresis, 295–8
- Electrochemical detector, 249
- Electron capture detector, 223
- Electron capture ionisation, resonance/dissociative, 182–3
- Electron excitation, 76
- Electron impact (EI) ionisation, 170
 drugs yielding molecular ions, 177
 GC–MS, 181
see also Ionisation
- Electrophoresis *see* Capillary
- Electrospray (ES) ionisation, 187
- ELSD (evaporative light scattering detector), 249
 non-ionic surfactants, 268–9
- Elution, gradient, non-ionic surfactants, 268–9
- Elution rate of ionisable compounds, pKa, 243–6
- Elutropic series, and mobile phases, TLC, 280–3
- Emission spectroscopy *see* Atomic emission; Molecular emission; Plasma emission spectroscopy
- Enantiomers, chiral HPLC, 270, 272
 R and S isomers, 33, 271, 306
- Energy states of atoms, 120
 nuclear magnetic resonance, 146
- Energy states of electrons
 fluorescence, 134
 ground state, 76, 134
- Ephedrine
 chiral derivatisation agents, 219–20
 TFA, 221
 UV spectrum, 83
- Errors in analysis
 causes, 4
 compound random errors, 9–10
 types of error, 2–4
- Ester groups
 back titration, 54
 phenolic, 41
- Ethanol
 EI mass spectrum, 171
 heterolytic alpha-cleavage, 172
 homolytic alpha-cleavage, 171
 quantitative analysis in a formulation, 228
see also Alcohol(s)
- Ethanol/sulphuric acid, corticosteroids, 286

- Ethinylloestradiol
fluorescence spectroscopy, 135, 136, 137–8
limit tests, TLC, 288
- Ethyl acetate, NMR spectrum, 151–2
- Ethylene, UV radiation excitation, 77
- Evaporative light scattering detector (ELSD), 249
non-ionic surfactants, 268–9
- Excipients
in creams and ointments, 315
solvent extraction methods, 315–19
in suspensions and solutions, 315
in tablets and capsules, 314
UV/visible spectrophotometry, 86–7, 96
- Extraction methods, 313–28
applications, 313
ion pair extraction, 317–19
solid phase extraction, 319–28
supercritical fluid extraction, 317–19
principles, 313
solvents, 315–19
- Eyedrops
derivatisation, HPLC, 270, 271
quantitative analysis, 226–9
- Famotidine
APCI mass spectra, 190, 191
degradant, characterisation with LC–MS, 188–9
structure, 190
- Faraday's constant, 60
- Faraday's Law, 68
- Fast atom bombardment (FRIT-FAB)
interface, 187
- Fatty acids, fixed oils, 216
- Fibroblast growth factor, stability, 139
- Fillers, 314–15
- Fingerprint technique
infrared spectrophotometry, 110–11
Raman spectroscopy, 142
- Flame ionisation detector, 223
- Flavonoids, micellar electrokinetic chromatography, 309–10
- Flavoxate, structure, 179
- Flow injection analysis, 69–71
applications, 71–3
fluorescent derivatives, 139
Karl Fischer titration, 71
- Fluorescence
intensity, interfering factors, 136–7
molecules exhibiting, 135–6
- Fluorescence detector, 250
- Fluorescence quantum yield, 135
- Fluorescence spectrophotometry, 133–9
applications, 133, 137–9
instrumentation, 134–5
principles, 133
- Fluorescent derivatives
flow injection analysis, 139
HPTLC, 291
- 5-Fluorouracil, physico-chemical properties, 42–3
- Fluphenazine, conversion into fluorescent derivatives, 139
- Formulations
drug release, 95–6
HPLC, 252–9
impurities and deviation from formulation, 15
preformulation, 94–6
Raman analysis, 142
- Fourier transform infrared (FT–IR)
detector, 224
instruments, 100–1
- Framycetin, qualitative TLC, 286
- Freeze-dried product, NIRA determination of water, 116
- Frusemide, UV/visible spectrophotometric assay, 86
- Gas chromatography, 207–35
applications, 207–8
bioanalysis, 233–4
determination of residual solvents, 231–3
manufacturing and degradation residues, 229–34
quantitative analysis, 224–8
capillary GC
carrier gas type/flow, 220
columns, 212, 222
film thickness, phase loading, 222
summary of parameters governing performance, 220–2
chiral derivatisation agents, 219–20
instrumentation, 208–12
column types, 211–12
detectors, 222–4
principles, 207
flow rate, effect of temperature, 221
Van Deemter equation, 200–1
selectivity of liquid stationary phases, 212–19
Kovats indices and column polarity, 212–13
McReynolds' constants, 213
temperature, effect on flow rate, 221
- Gas chromatography–mass spectrometry (GC–MS), 180–6
applications, impurity profiling, 183–5
ionisation
electron impact (EI), 181
negative ion chemical (NICI), 182–3
positive ion chemical (PICI), 181–2
- Gaussian absorption band, derivative spectra, 92
- Gel permeation chromatography (GPC),
hyaluronic acid assay, 267–8
- Gentamicin sulphate, solvent residues, GC, 231–3
- Geometrical isomerism, 33
- Glass electrode, pH-sensitive, 65
- Glassware
manufacturer's tolerances, 50
compound random errors, 9–10
- Glucose i.v. infusion, assay, AES, 124–5
- Glutaraldehyde, in polymeric film, 230
- Glycine, in formulations, Raman analysis, 142–3
- GR50360, separation on basis of ionic radius, CE, 301–2
- Gradient elution, non-ionic surfactants, 268–9
- Guanethidine, physico-chemical properties, 45
- Guanidine group, 45
- ^3H , radiochemical detector, 224
- Haemodialysis solutions
aluminium determination, 138
Ca and Mg by AAS, 127
- Half-life of drug molecule, 32
- Head space analysis, solvent residues, GC, 231–2
- Henderson–Hasselbalch equation, 20
buffers, 24
partition coefficient, 29–30
- Heroin, Raman analysis, 142
- High performance capillary electrophoresis
see Capillary electrophoresis
- High-pressure liquid chromatography
applications, 238, 252–76
calibration against external standard, 252–9
calibration against internal standard, 259–64
drugs in formulations, 252–9
more specialised techniques, 264–76
response factors, 262
capacity factor K' , 195–6
chiral
enantiomers, 270
Pirkle-type phases, 271–2
column efficiency N_{eff} , 196–7
column performance
laminar flow, 296
peak asymmetry, 203
resolution, 201–2
data acquisition, 203–4
peak threshold setting, 204
derivatisation, 270
instrumentation, 238–9
detectors, 248–52
principles, 238

- High-pressure liquid chromatography applications (*contd*)
 band broadening, 197–201
 eddy diffusion, 198–9
 report generation, 204–5
 retention time and peak width, 197
 stationary and mobile phases, 239–41
 mobile phase pH, 243–6
 reverse-phase solvents, 240
 straight-phase solvents, 240
 summary of stationary phases, 246–7
 structural factors governing rate of elution, 241–6
 Van Deemter equation, 197–8
 void volume and capacity factor, 195–6
- Holmium perchlorate, absorbance maxima, 81
- Hyaluronic acid assay, size exclusion chromatography, 267–8
- Hydrochlorothiazide, and lactose, NIRA determination of blend uniformity, 114
- Hydrocortisone
 absorption maximum, 83
 cream, one-point calibration against internal standard, HPLC, 260–3
 IR absorption, interpretation, 108
 limit tests, TLC, 287
 structure, TLC, 281
 UV spectrum, 82
- Hydrogen chloride, IR absorbance, 98
- I*-values, 212–13
- Ibuprofen
 HPLC analysis, 244
 TLC, 282–3
- Immunoaffinity gels, adsorbents, 326–7
- Imipramine, structure and p*K*_a, 311
- Impurities, general, sources, 15
- Indicator dyes, 51–4
 ion pair titrations, 63–4
- Indomethacin, CE, 302–3
- Inductively coupled plasma emission spectroscopy, 130–1
- Infrared radiation, ranges, 98
- Infrared spectrophotometry, 97–117
 applications, 97
 fingerprint technique, 110–11
 identifying polymorphs, 111–12
 to structure elucidation, 104
 instrumentation, 100–2
 calibration, 101–2
 continuous wave, 101
 Fourier transform, 100–1
 principles, 97
 radiation intensity and energy level, absorption factors, 99–100
 sample preparation, 102–4
 attenuated total reflectance, 103–4
 diffuse reflectance, 102, 103
see also Near-infrared analysis (NIRA)
- Injection systems
 cool on-column injection, 211
 gas chromatography, 209–11
- Insulin-like growth factor, impurities, ES–MS, 188–9
- Interferometer, Fourier transform IR instruments, 100–1
- Iodine
 as lipophilic anion, titration with potassium iodate, 64
 as vapour, TLC, 285
 Iodine displacement titrations, 62
 Iodine-absorbing substances, penicillins, 63
 Iodometric titrations, 61–3
- Ion exchange chromatography, catecholamines, 269–70
- Ion mobility, p*K*_a, 294–5
- Ion pair chromatography
 adrenaline assay, 264–5
 ascorbic acid, 265–6
 chiral HPLC, 273
 Ion pair extraction, 317–19
 Ion pair titrations, 63–4
- Ion separation methods
 ion trap, 188
 matrix-assisted laser desorption with time of flight (MALDI-TOF), 187
 tandem mass spectrometry (MS–MS), 188
 Ion velocity, 294
- Ionic strength, and dielectric constant, 27–8
- Ionisation, 21–3
 AES, 123
 at given pH, 20–1
 atmospheric pressure (API), 187
 electron capture, resonance/dissociative, 182–3
 electron capture detector, 223
 electron impact (EI), in mass spectrometry, 170, 181
 electrospray (ES), 187
 flame ionisation detector, 223
 negative ion, chemical ionisation (NICI), 178, 182–3
 positive ion, chemical ionisation (PICI), 181–2
- Isomerism
 geometrical, 33
 optical, 33
- Isoniazid, HPTLC, 291–2
- Isoprenaline, physico-chemical properties, 44
- Isoxsuprine, structure, 37
- Kaempferol, structure, 310
- Karl Fischer titration, 68
 flow injection analysis, 71
- Keiseliguhr, stationary phase in TLC, 281, 284–5
- Ketobutorphanol
 impurities and degradants, ES–MS, 191
 structure, 193
- Ketone group, neutral, 44
- Ketoprofen, UV spectrum, 83
- Kovats indices, and column polarity, gas chromatography, 212–13
- K*_a
 dissociation constant, 18–19
see also p*K*_a
- Labetalol
 diastereoisomers, 36–7
 enantiomers, 272
- Lactam ring, 41, 63
- Lactose, and hydrochlorothiazide, NIRA determination of blend uniformity, 114
- Laminar flow, column performance in HPLC, 296
- Lead, in sugars, by atomic absorption spectrophotometry, 129
- Levamisole, qualitative TLC, 286
- Lignocaine adrenaline injection, UV/visible spectrophotometric assay, 89–90
- Limit of detection, defined, 11–12
- Limonene, EI mass spectrum, 176
- Lincomycin, potassium permanganate, TLC, 285
- Linearity, defined, 12–13
- Liquid chromatography, *see also* High-pressure liquid chromatography
- Liquid chromatography–mass spectrometry (LC–MS), 186–93
 applications, 188–93
 ion separation methods, 187–8
 LC–MS interfaces, 186–7
- Lithium, atomic emission spectrophotometry, 119–25
- Local anaesthetics
 pH, p*K*_a in HPLC, 244–5
 separation by CE, 306–7
- Loprazolam, limit tests, TLC, 288
- Lubricants, tablets, 314
- Luteolin, structure, 310
- McLafferty rearrangement, 180
- Magnesium, AAS, haemodialysis solutions, 127
- Mannitol, lead content, AAS, 129
- Manufacturing and degradation residues, gas chromatography, 229–34
- Mass spectrometry, 167–93
 applications, 167
 electron impact ionisation conditions, 170

- Mass spectrometry (*contid*)
GC-MS, 180–6
instrumentation, 168–70
magnetic sector instruments, 169
quadrupole instruments, 169–70
LC-MS, 186–93
molecular fragmentation patterns, 171–5
cleavage with proton transfer, 173–4
dominant homolytic alpha-cleavage, 177
homolytic/heterolytic alpha-cleavage, 171–3
isotope peaks, 177–9
ring structures, 175
typical small fragments, 174
principles, 167
tandem (MS-MS), 188
- Matrix-assisted laser desorption with time of flight (MALDI-TOF), 187
- Mefenamic acid, TLC, 282–3
limit tests, TLC, 288
- Menotrophin, solvent residues, GC, 231–3
- Menthol, chrysanthemyl esters, 219
- Menthyl acetate, 213–15
- Mepivacaine
association constant, 307
separation by CE, 306–7
- Mepyramine, structure, 180
- Metal salts, compleximetric titrations, 58–9
- Metals, limit tests
AAS, 127–9
flow injection analysis, 72
trace metals in wound dressings, AAS, 130
- Methane, PICI spectrum, 182
- Methanol, dielectric constant, 28
- Methyl acetate, NMR spectrum, 149
- Methyl orange indicator, 51–3
- Methylene, IR vibration modes, 99
- Methylparaben, single point calibration, HPLC, 257–9
- Methyltestosterone
structure and HPLC elution, 242
tablets, quantitative analysis, 225–6
- Metipranolol, separation by CE, 302
- Metoprolol, structure, 179
- Mexiletine, limit tests, TLC, 288
- Micellar electrokinetic chromatography, 307–10
- Michelson interferometer, Fourier transform IR instruments, 100–1
- Miconazole cream, calibration against internal standard, HPLC, 263–4
- Microprocessor, automation of wet chemical titrations, 68–71
- Microwave-induced plasma atomic emission detector, 224
- Moisture determination, NIRA, 116
- Molecular emission spectroscopy, 133–43
fluorescence spectrophotometry, 133–9
Raman spectroscopy, 140–3
- Molecular fragmentation patterns, 171–5
Diels–Alder, 175
- Monoclonal antibodies, immunoaffinity gels, 327
- Morphine
ionic mobility, 295
Raman analysis, 142
- Mulls, IR spectroscopy, 103
- Nandrolone, structure and HPLC elution, 242
- Naproxen
interaction with silica gel in HPLC, 240
and mobile phases in TLC, 283
- Narigenin, structure, 310
- Near-infrared analysis (NIRA), 112–17
applications, 112, 113–17
activity of multicomponent dosage forms, 114–15
determination of blend uniformity, 114
determination of polymorphs, 115–16
in-pack activity, 115
moisture determination, 116
shampoo, process control of components, 117
principles, 112
- Negative ion chemical ionisation (NICI), 182–3
- Neomycin, derivatisation, HPLC, 270, 271
- Nernst equation, 60
glass electrode, 66
- Ninhydrin, TLC, 285–6
- Nitroaniline, NMR spectrum, 150–1
- Nitrobenzene, NMR spectrum, 150–1
- Nitrogen
diazine ring, 43
sulphonamide, 43
ureide, 42
- Nitrogen/phosphorus detector, 223
- Non-aqueous acid–base titrations, 56–8
- Noradrenaline, fluorescence, 136
- Nortriptyline, structure and pKa, 311
- NSAIDs
flow injection analysis, 71
mobile phases in TLC, 282–3
separation on basis of ionic radius, CE, 302–3
- Nuclear magnetic resonance spectroscopy, 145–66
applications, 145
quantitative analysis, 163–4
other, 164–5
biological NMR, 165
carbon-13 NMR, 159–61
chiral NMR, 165
instrumentation, 147–8
- principles, 145
proton NMR, 148–59
spin spin coupling, 151–2
two-dimensional NMR, 161–3
- Oestradiol, structure and HPLC elution, 242
- Oils
acid value, 54–5
fixed, GC analysis, 216
saponification value, 54–5
- Ointments, excipients, 315
- Opioids
fingerprint Raman technique, 142
see also Codeine; Morphine
- Optical isomerism
and chirality, 33–6
dextro/laevorotatory forms, 34
polarimetry, 34
- Optical rotation, 38–9
- P_{app} (apparent partition coefficient), 29
- Paracetamol
analytical method (SOP), 8
with aspirin, HPLC, narrow range calibration curve, 256–7
HPLC, analysis using calibration curve, 253–5
IR absorption, interpretation, 105, 106, 111
physico-chemical properties, 40
proton NMR spectrum, 155
quantitative technique, 163–4
- Particle beam interface, 186
- Partition coefficient, 28–31
effect of pH, 29–30
flow injection analysis, 73
Henderson–Hasselbalch equation, 29–30
UV/visible spectrophotometry, 95
- Partitioning, between organic solvents, 316–17
- Pascal's triangle, 154
- Penicillins
iodine-absorbing substances, 63
IR absorption, interpretation, 108, 109
limit tests, TLC, 288
micellar electrokinetic chromatography, 308–9
physico-chemical properties, 41–2
UV/visible spectrophotometric assay, 88–9
- Pentagastrin, qualitative TLC, 286
- Pentycaine
separation by CE, 306–7
structure and HPLC, 245–6
- Peppermint oil, components, structures, 213–15

- Peptide drugs
 monoclonal antibodies, immunoaffinity gels, 327
 stability determination, 139
- Peptides, separation by CE, 304–5
- Perchloric acid, non-aqueous titration, 57
- pH
 bathochromic/hyperchromic shift, 78
 mobile phase HPLC, 243–6
 and pKa, elution rate of ionisable compounds, HPLC, 243–6
- pH determination, 18–21
 acids and bases, 18–20
 dissociation of water, 18
- pH-sensitive glass electrode, 65
- Phenacetin, NMR spectrum, 158
- Phenobarbitone, fluorescence, 136
- Phenolic ester groups, 41
- Phenolphthalein, 51–4
- Phenols
 micellar electrokinetic chromatography, 309–10
 UV absorption characteristics, 78
- Phenylalanine, PFP–TFE derivatives, 218–19
- Phenylephrine
 NMR spectrum, 159
 non-aqueous titration, 58
 UV spectrum, acidic/basic, 84–5
- Phosphate buffers, 25
- Phosphorus/nitrogen detector, 223
- Physico-chemical properties of drug molecules, 17–47
 activity, ionic strength and dielectric constant, 27–8
 buffers, 23–6
 drug profiles, 39–47
 ionisation, 21–3
 optical rotation, 38–9
 partition coefficient, 28–31
 pH determination, 18–21
 salt hydrolysis, 26–7
 solubility, 95
 stereochemistry, 32–8
 UV/visible spectrophotometry, 94–6
- Pilocarpine, separation with cyclodextrins as additives in running buffer, 305–6
- Pirkle phases, chiral HPLC, 271–2
- Piroxicam, CE, 302–3
- Pivalic acid, eyedrops, residue analysis, 229
- pKa
 defined, 20
 degree of ionisation, 22–3
 determination by potentiometric titrations, 66–8
 determination by UV/visible spectrophotometry, 85
 elution rate of ionisable compounds, HPLC, 243–6
 ion mobility, 294–5
- Plasma emission detector, 224
- Plasma emission spectroscopy, inductively coupled, 130–1
- Polarimetry, optical rotation, 34, 38–9
- Polarity index, solvents, 282
- Polynes, longest wavelength maxima, 78
- Polymeric film, determination of glutaraldehyde, 230
- Polymorphs
 fingerprint regions, IR DRIFT, 112
 IR spectrophotometry, 111–12
 NIRA, 115–16
- Polystyrene, IR instrument calibration, 101–2
- Positive ion chemical ionisation (PICI), 181–2
- Potassium, atomic emission spectrophotometry, 121–3
- Potassium bicarbonate, assay, 122
- Potassium bromide discs, IR spectroscopy, 103
- Potassium chloride, assay, AES, 124–5
- Potassium dichromate, UV spectrum, 81
- Potassium permanganate, TLC, 285
- Potentiometric titrations, 65–8
 pKa value determination, 66–8
- Precision in analytical methods, 2–6
 relative SD (RSD), 5–6
 repeatability and reproducibility, 6–8
 within-assay precision, 6–7
- Prednisolone
 NIRA, 117
 physico-chemical properties, 44–5
 qualitative, TLC 286
 structure and HPLC elution, 242
- Prilocaine, structure and HPLC, 245–6
- Procainamide, structure, 179
- Procaine
 fluorescence, 136
 limit tests, TLC, 290
 NIRA, 117
 physico-chemical properties, 39–40
¹³C NMR spectrum, 161
 structure and HPLC, 245–6
 UV spectrum, acidic/basic, 84
- Promethazine
 flow injection analysis, 72
 limit tests, TLC, 290
- Propranolol
 EI spectrum, 184
 GC–MS, impurity profiling, 183–5
 major fragmentation mechanisms, 185
 MS fragmentation, impurity peak, 186
 synthetic route, 184
- Propyl acetate, NMR spectrum, 153
- Prostaglandin, supercritical fluid extraction, 319
- Protein assay, wide-pore HPLC packing, 266–7
- Proteins, quality control, ES–MS, 188–9
- Proton NMR, 148–59
- Proton–proton correlation (COSEY), 161–3
- Protons, carbon-attached, chemical shift values, 149
- Protriptyline, UV absorption characteristics, 78
- Pseudoephedrine
 chiral derivatisation agents, 219–20
 drug release from formulation, 95–6
 single point calibration, HPLC, 257–9
 UV/visible spectrophotometry, derivative spectra, 93–4
- Psoralen
 PICI spectrum, 181–2
 TIC GC spectrum, 181
- Pulsed amperometric detector, 249
- Purge trap analysis, solvent residues, GC, 233
- Pyrazinamide, HPTLC, 291–2
- Pyridostigmine bromide, physico-chemical properties, 45
- Quality control, 1–15
- Quantitative analysis
 gas chromatography, 224–8
 NMR spectroscopy, 163–4
 titrimetric and chemical analysis, 49–74
 UV/visible spectrophotometry, 86–9
- Quaternary ammonium ions, 45
- Quercetin, structure, 310
- Quinine, fluorescence, 135–6
- Racemic mixtures, 35
- Radiochemical detector, 224
- Raman scatter, 135, 141
- Raman spectroscopy, 140–3
 applications, 140, 142–3
 instrumentation, 141–2
 principles, 140
 Stokes/anti-Stokes shift, 140–1
- Range of analytical method, defined, 13
- Rayleigh scatter, 135
- Reaction potential, 59–60
- Recombinant proteins, quality control ES–MS, 188–9
- Redox titrations, 59–61
- Reduction potential E_{r} , 59
- Refractive index (RI) detector, 250, 268
- Relative SD (RSD), precision in analytical methods, 5–6
- Repeatability and reproducibility, 6–8
- Rf value, TLC, 280
- Riboflavin, fluorescence, 136
- Rifampicin, HPTLC, 291–2
- Robustness, defined, 13

- Ropivacaine
association constant, 307
separation by CE, 306–7
- Salbutamol
proton NMR spectrum, 156–8
¹³C NMR spectrum, 160
- Salt hydrolysis, 26–7
- Saponification value, oils, 54–5
- Selectivity/sensitivity, defined, 13–14
- Shampoo, process control of components, 117
- Shelf-life of drugs, 32
- Silanization
calcium silicate, 211–12
silica gel, 284
- Silica gels
adsorbant, solid phase extraction, 321–5
factors requiring attention in SPE, 325–6
KOH-impregnated, 283
polar surface-modified, 323
silanised, 284
stationary phase in HPLC, 239–40
stationary phase in TLC, 279–80, 281
mobile phases, 283
surface-modified
anion exchangers, 324–5
cation exchangers, 324–5
types, 247
- Silicones, McReynolds' constants, 213
- Silver nitrate, argentimetric titrations, 58
- Size exclusion chromatography, hyaluronic acid assay, 267–8
- Sodium
in albumin solution, 125
atomic emission spectrophotometry, 121–3
electronic transitions, 120
- Sodium chloride, assay, AES, 124–5
- Solid phase extraction, 319–28
adsorbants used, 321–2, 324
applications, 319
automated online prior to HPLC, 327–8
principles, 319, 320–1
vacuum manifold, 321
reverse-phase, 323
straight-phase, 324
- Solubility, UV/visible spectrophotometry, 95
- Solvent residues, GC
direct injection, 231
head space analysis, 231–2
purge trap analysis, 233
- Solvents
addition to buffers in HPLC, 246
elutropic series, 282
extraction methods, 315–19
mobile phases in TLC, 283
partitioning, 316–17
polarity index, 282
stationary phase HPLC, straight-phase and reverse-phase, 240
- Spectinomycin, potassium permanganate, TLC, 285
- Spectrophotometry *see* Atomic –; Infrared –; Ultraviolet/visible –
- Stability of drug molecules, 31–2
first order degradation, 31
half-life, 32
peptide drugs, 139
shelf-life, 32
zero order degradation, 31
- Standard operating procedures (SOPs), examples, 8–9
- Standards
external/internal calibration, HPLC, 259–64
primary/secondary, 50–1
- Starch indicator, diazotisation titrations, 64
- Stationary phases
HPLC, 239–41
McReynolds' constants, 213
selectivity, liquid phases, 212–19
thin layer chromatography, 280, 281
- Stereochemistry, 32–8
diastereoisomers, 36–8
enantiomers, 34–5
isomers and chirality, 33–6
racemic mixtures, 35
- Steroid enones, UV spectrum, 82
- Steroids
alkaline tetrazolium blue, 286
migration, TLC, 281
NIRA, 116
one-point calibration against internal standard, HPLC, 260–3
structural factors governing rate of elution, HPLC, 241–3
structure, TLC, 281
- Stokes/anti-Stokes shift, Raman spectroscopy, 140–1
- Strong anion/cation exchangers (SAX/SCX), 247
- Sugars, lead content, AAS, 129
- Sulindac, CE, 302–3
- Sulphadiazine, physico-chemical properties, 43
- Sulphamethoxazole, IR DRIFT, fingerprint regions of polymorphs, 112
- Sulphonamides
diazotisation titrations, 64
sulphacetamide, 64
- Supercritical fluid extraction, 317–19
- Surfactants
ion pair titrations, 63–4
non-ionic, analysis with ELSD, 268–9
- Suspensions and solutions, in excipients, 315
- Sympathomimetic drugs, 44
- Syringes, gas chromatography, 209
- Tablets and capsules, excipients in, 314
- Tandem mass spectrometry (MS–MS), 188
- Taurine, extraction, GC–MS, 317
- Testosterone
structure
and HPLC elution, 242
and TLC, 281
tablets, quantitative analysis, 225–6
- Tetramethylsilane, NMR, 148
- Tetrazolium blue, alkaline, 286
- Thalidomide, chirality, 35
- Thermal conductivity detector, 223
- Thermospray interface, 186
- Thin layer chromatography, 277–92
adsorbent modification, 283–5
applications, 277
known/unknown standards, 290
limit tests, 287–9
qualitative TLC, 286
detection of compounds, 285–6
elutropic series and mobile phases, 280–3
high performance, 290–2
applications, 291
instrumentation, 290
instrumentation, 278–9
principles, 277
stationary phases, 280, 281
- Thioether group, 41
- Tiaprofenic acid, CE, 302–3
- Tin, trace, in wound dressings, 130
- Titrimetric and chemical analysis, 49–74
acid/base titrations, 51–8
automation, 68–71
glassware, 9–10, 50
principles, 49–50
standards, 50–1
- Toluene, in hexane solution, absorbance ratio, 81
- Tranexamic acid, proton–proton correlation spectrum, 162
- Triamcinolone
limit tests, TLC, 290
structure, TLC, 281
- Triethanolamine, 302
- Trifluoroacetic anhydride, derivatisation of pseudoephedrine, 219–20
- Triglycerides
methanolysis, 217
see also Oils
- Trimetazidine, structure, 180
- Trimethylsilyl group, atropine quantitative analysis, 226–8
- Tripolidine, single point calibration, HPLC, 257–9

- Tropylium ion, 179
Tyndall scatter, 135
- Ultraviolet radiation, TLC, 285
- Ultraviolet/visible radiation
absorption, 77–9
chromophores, 78
Beer–Lambert Law, 79
variable wavelength UV detector, 248
- Ultraviolet/visible spectrophotometry, 75–96
applications, 75–6
determination of p*K*_a values, 85
drug release from formulation, 95–6
quantitative analysis, 86–9
to preformulation and formulation, 94–6
derivative spectra, 92–4
determination of stray light, 82
difference spectrophotometry, 90–1
instrument calibration, 80–2
- instrumental resolution, 81–2
instrumentation, 80
principles, 75–6
radiation absorption factors, 77–9
- Urine
catecholamines, ion exchange chromatography, 269–70
K, Na by AES, 125
- Vaccines, Ca by AES, 125
- Valproic acid, bioanalysis (GC), 233–4
- Van Deemter equation
gas chromatography, 200–1
HPLC, 197–8
- Van der Waals interaction, 265, 321–2
- Variable wavelength UV detector, 248
- Viscosity, AES, 123
- Vitamins
C, ion pair chromatographic assay, 265–6
E, supercritical fluid extraction, 318–19
- Warfarin sodium, solvent residues, GC, 231–3
- Water
dielectric constant, 28
loss by 1,4 elimination, 173
NIRA determination, 116
pH determination, 18
- Wavelength scale, calibration, 81
- Weighing
balance, calibrated, SOP, 9
by difference, 14
- Wet chemical methods
automation, 68–71
flow injection analysis, 69–71
- Wound dressings, trace metals, AAS, 130
- Zero order kinetics, degradation rate, 31
- Zimeldine, structure, 33
- Zinc, atomic absorption spectrophotometry, 126, 128