

Inorganic Chemistry

Taro Saito

Preface

The author has tried to describe minimum chemical facts and concepts that are necessary to understand modern inorganic chemistry. All the elements except superheavy ones have been discovered and theoretical frameworks for the bonding, structure and reaction constructed. The main purposes of inorganic chemistry in near future will be the syntheses of the compounds with unexpected bonding modes and structures, and discoveries of novel reactions and physical properties of new compounds.

More than ten million organic compounds are known at present and infinite number of inorganic compounds are likely to be synthesized by the combination of all the elements. Recently, really epoch making compounds such as complex copper oxides with high-temperature superconductivity and a new carbon allotrope C_{60} have been discovered and it is widely recognized that very active research efforts are being devoted to the study of these compounds. By the discoveries of new compounds, new empirical laws are proposed and new theories are established to explain the bondings, structures, reactions, and physical properties. However, classical chemical knowledge is essential before studying new chemistry. Learning synthetic methods, structures, bondings, and main reactions of basic compounds is a process requisite to students.

This text book describes important compounds systematically along the periodic table, and readers are expected to learn typical ones both in the molecular and solid states. The necessary theories to explain these properties of compounds come from physical chemistry and basic concepts for learning inorganic chemistry are presented in the first three chapters.

Inorganic chemistry is of fundamental importance not only as a basic science but also as one of the most useful sources for modern technologies. Elementary substances and solid-state inorganic compounds are widely used in the core of information, communication, automotive, aviation and space industries as well as in traditional ones. Inorganic compounds are also indispensable in the frontier chemistry of organic synthesis using metal complexes, homogeneous catalysis, bioinorganic functions, *etc.* One of the reasons for the rapid progress of inorganic chemistry is the development of the structural determination of compounds by X-ray and other analytical instruments. It has now become possible to account for the structure-function relationships to a considerable extent by the accumulation of structural data on inorganic compounds. It is no exaggeration to say that a revolution of inorganic chemistry is occurring. We look forward to the further development of inorganic chemistry in near future.

The present text is a translation from a Japanese text book in the series of

introductory courses for the freshman, and junior students. The series has been welcome widely in Japan since their first publication in 1996 as unique approaches to modern chemistries that are becoming too complex to learn during the short period of university courses. This internet version is intended to offer free textbooks for those students who have little access to the printed version and we hope that readers will benefit from this experimental edition. The author expresses his acknowledgments to Professor Yoshito Takeuchi for his efforts to realize the project and Iwanami Publishing Company to approve the publication of the internet edition without claiming a copyright for translation.

May 10, 2004
Kanagawa University

Taro Saito

Contents

1 Elements and periodicity

1.1 The origin of elements and their distribution	1
1.2 Discovery of elements	2
1.3 Electronic structure of elements	2
1.4 Block classification of the periodic table and elements	6
1.5 Bonding states of elements	7

2 Bonding and structure

2.1 Classification of bonding	11
2.2 Geometrical factors governing bonding and structure	12
2.3 Electronic factors which govern bonding and structure	27

3 Reaction

3.1 Thermodynamics	41
3.2 Electrochemistry	42
3.3 Oxidation and reduction	45
3.4 Acid and base	48

4 Chemistry of nonmetallic elements

4.1 Hydrogen and hydrides	54
4.2 Main group elements of 2nd and 3rd periods and their compounds	58
4.3 Oxygen and oxides	66
4.4 Chalcogen and chalcogenides	86
4.5 Halogens and halides	89
4.6 Rare gases and their compounds	98

5 Chemistry of main-group metals

5.1 Group 1 metals	101
5.2 Group 2 metals	103
5.3 Group 12 metals	105
5.4 Group 13 metals	105
5.5 Group 14 metals	108

6 Chemistry of transition metals	
6.1 Structures of metal complexes	110
6.2 Electronic structure of complexes	116
6.3 Organometallic chemistry of d block metals	130
6.4 Reactions of complexes	148
7 Lanthanoids and actinoids	
7.1 Lanthanoids	154
7.2 Actinoids	155
8 Reaction and physical properties	
8.1 Catalytic reactions	159
8.2 Bioinorganic chemistry	163
8.3 Physical properties	166

1 Elements and Periodicity

The elements are found in various states of matter and define the independent constituents of atoms, ions, simple substances, and compounds. Isotopes with the same atomic number belong to the same element. When the elements are classified into groups according to the similarity of their properties as atoms or compounds, the periodic table of the elements emerges. Chemistry has accomplished rapid progress in understanding the properties of all of the elements. The periodic table has played a major role in the discovery of new substances, as well as in the classification and arrangement of our accumulated chemical knowledge. The periodic table of the elements is the greatest table in chemistry and holds the key to the development of material science. Inorganic compounds are classified into molecular compounds and solid-state compounds according to the types of atomic arrangements.

1.1 The origin of elements and their distribution

All substances in the universe are made of elements. According to the current generally accepted theory, hydrogen and helium were generated first immediately after the Big Bang, some 15 billion years ago. Subsequently, after the elements below iron ($Z = 26$) were formed by nuclear fusion in the incipient stars, heavier elements were produced by the complicated nuclear reactions that accompanied stellar generation and decay.

In the universe, hydrogen (77 wt%) and helium (21 wt%) are overwhelmingly abundant and the other elements combined amount to only 2%. Elements are arranged below in the order of their abundance,

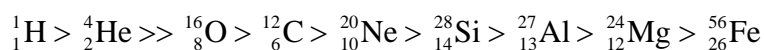

The **atomic number** of a given element is written as a left subscript and its **mass number** as a left superscript.

1.2 Discovery of elements

The long-held belief that all materials consist of atoms was only proven recently, although elements, such as carbon, sulfur, iron, copper, silver, gold, mercury, lead, and tin, had long been regarded as being atom-like. Precisely what constituted an element was recognized as modern chemistry grew through the time of alchemy, and about 25 elements were known by the end of the 18th century. About 60 elements had been identified by the middle of the 19th century, and the periodicity of their properties had been observed.

The element technetium ($Z = 43$), which was missing in the periodic table, was synthesized by nuclear reaction of Mo in 1937, and the last undiscovered element promethium ($Z = 61$) was found in the fission products of uranium in 1947. Neptunium ($Z = 93$), an element of atomic number larger than uranium ($Z = 92$), was synthesized for the first time in 1940. There are 103 named elements. Although the existence of elements $Z = 104-111$ has been confirmed, they are not significant in inorganic chemistry as they are produced in insufficient quantity.

All trans-uranium elements are radioactive, and among the elements with atomic number smaller than $Z = 92$, technetium, promethium, and the elements after polonium are also radioactive. The half-lives (refer to Section 7.2) of polonium, astatine, radon, actinium, and protoactinium are very short. Considerable amounts of technetium ^{99}Tc are obtained from fission products. Since it is a radioactive element, handling ^{99}Tc is problematic, as it is for other radioactive isotopes, and their general chemistry is much less developed than those of manganese and rhenium in the same group.

Atoms are equivalent to alphabets in languages, and all materials are made of a combination of elements, just as sentences are written using only 26 letters.

1.3 Electronic structure of elements

Wave functions of electrons in an atom are called **atomic orbitals**. An atomic orbital is expressed using three quantum numbers; the **principal quantum number**, n ; the **azimuthal quantum number**, l ; and the **magnetic quantum number**, m_l . For a principal quantum number n , there are n azimuthal quantum numbers l ranging from 0 to $n-1$, and each corresponds to the following orbitals.

$$l: 0, 1, 2, 3, 4, \dots$$

$$s, p, d, f, g, \dots$$

An atomic orbital is expressed by the combination of n and l . For example, n is 3 and l is 2 for a $3d$ orbital. There are $2l+1$ m_l values, namely $l, l-1, l-2, \dots, -l$. Consequently, there are one s orbital, three p orbitals, five d orbitals and seven f orbitals. The three aforementioned quantum numbers are used to express the distribution of the electrons in a hydrogen-type atom, and another quantum number m_s ($1/2, -1/2$) which describes the direction of an electron spin is necessary to completely describe an electronic state. Therefore, an electronic state is defined by four quantum numbers (n, l, m_l, m_s).

The wave function ψ which determines the orbital shape can be expressed as the product of a radial wavefunction R and an angular wave function Y as follows.

$$\psi_{n,l,m_l} = R_{n,l}(r)Y_{l,m_l}(\theta, \phi)$$

R is a function of distance from the nucleus, and Y expresses the angular component of the orbital. Orbital shapes are shown in Fig. 1.1. Since the probability of the electron's existence is proportional to the square of the wave function, an electron density map resembles that of a wave function. The following conditions must be satisfied when each orbital is filled with electrons.

[The conditions of electron filling]

Pauli principle: The number of electrons that are allowed to occupy an orbital must be limited to one or two, and, for the latter case, their spins must be anti-parallel (different direction).

Hund's rule: When there are equal-energy orbitals, electrons occupy separate orbitals and their spins are parallel (same direction).

The order of orbital energy of a neutral atom is

$$1s < 2s < 2p < 3s < 3p < 4s < 3d < 4p \dots$$

and the electron configuration is determined as electrons occupy orbitals in this order according to the Pauli principle and Hund's rule. An s orbital with one m_l can accommodate 2 electrons, a p orbital with three m_l 6 electrons, and a d orbital with five m_l 10 electrons.

Exercise 1.1 Describe the electron configuration of a C atom, an Fe atom, and a Au atom.

[Answer] Electrons equal to the atomic number are arranged in the order of orbital energies. Since the electrons inside the valence shell take the rare gas configuration, they may be denoted by the symbol of a rare gas element in brackets.

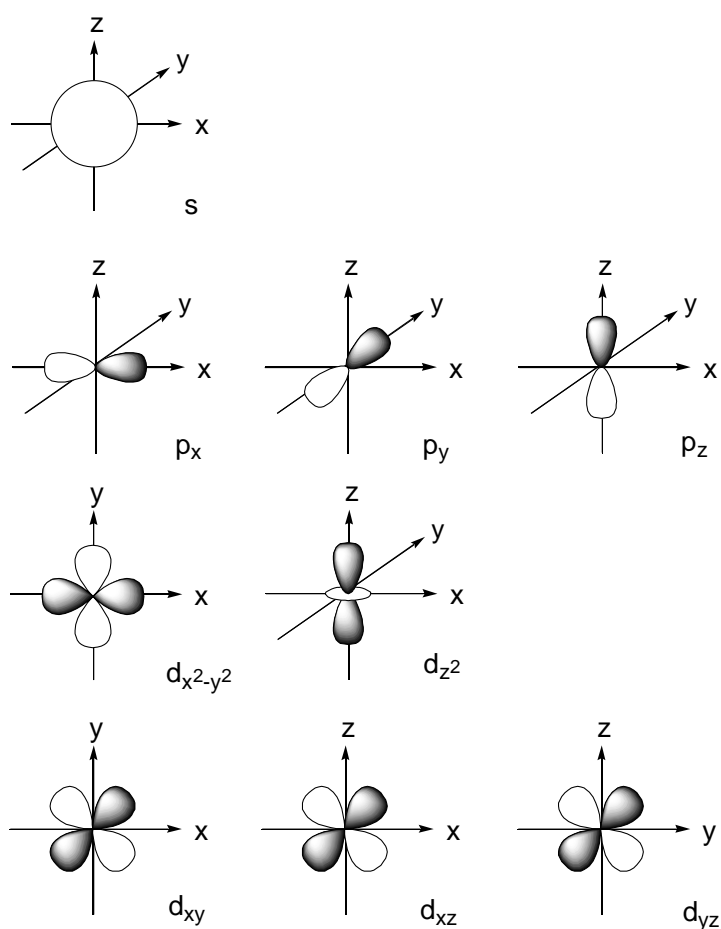
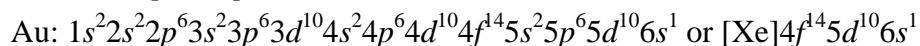
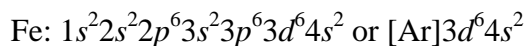
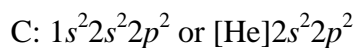

Fig. 1.1 Shapes of *s*, *p*, and *d* orbitals.

Table 1.1 Periodic table of elements. The values are atomic weights.

	1	2	3	4	5	6	7	8	9
1	1.008 ${}_1\text{H}$								
2	6.941 ${}_3\text{Li}$	9.012 ${}_4\text{Be}$							
3	22.99 ${}_{11}\text{Na}$	24.31 ${}_{12}\text{Mg}$							
4	39.10 ${}_{19}\text{K}$	40.08 ${}_{20}\text{Ca}$	44.96 ${}_{21}\text{Sc}$	47.87 ${}_{22}\text{Ti}$	50.94 ${}_{23}\text{V}$	52.00 ${}_{24}\text{Cr}$	54.94 ${}_{25}\text{Mn}$	55.85 ${}_{26}\text{Fe}$	58.93 ${}_{27}\text{Co}$
5	85.47 ${}_{37}\text{Rb}$	87.62 ${}_{38}\text{Sr}$	88.91 ${}_{39}\text{Y}$	91.22 ${}_{40}\text{Zr}$	92.91 ${}_{41}\text{Nb}$	95.94 ${}_{42}\text{Mo}$	(99) ${}_{43}\text{Tc}$	101.1 ${}_{44}\text{Ru}$	102.9 ${}_{45}\text{Rh}$
6	132.9 ${}_{55}\text{Cs}$	137.3 ${}_{56}\text{Ba}$	Lantha- noid	178.5 ${}_{72}\text{Hf}$	180.9 ${}_{73}\text{Ta}$	183.8 ${}_{74}\text{W}$	186.2 ${}_{75}\text{Re}$	190.2 ${}_{76}\text{Os}$	192.2 ${}_{77}\text{Ir}$
7	(223) ${}_{87}\text{Fr}$	(226) ${}_{88}\text{Ra}$	Acti- noid						
Lanthanoid			138.9 ${}_{57}\text{La}$	140.1 ${}_{58}\text{Ce}$	140.9 ${}_{59}\text{Pr}$	144.2 ${}_{60}\text{Nd}$	(145) ${}_{61}\text{Pm}$	150.4 ${}_{62}\text{Sm}$	152.0 ${}_{63}\text{Eu}$
Actinoid			(227) ${}_{89}\text{Ac}$	232.0 ${}_{90}\text{Th}$	231.0 ${}_{91}\text{Pa}$	238.0 ${}_{92}\text{U}$	(237) ${}_{93}\text{Np}$	(239) ${}_{94}\text{Pu}$	(243) ${}_{95}\text{Am}$

10	11	12	13	14	15	16	17	18
								4.003 ${}_2\text{He}$
			10.81 ${}_5\text{B}$	12.01 ${}_6\text{C}$	14.01 ${}_7\text{N}$	16.00 ${}_8\text{O}$	19.00 ${}_9\text{F}$	20.18 ${}_{10}\text{Ne}$
			26.98 ${}_{13}\text{Al}$	28.09 ${}_{14}\text{Si}$	30.97 ${}_{15}\text{P}$	32.07 ${}_{16}\text{S}$	35.45 ${}_{17}\text{Cl}$	39.95 ${}_{18}\text{Ar}$
58.69 ${}_{28}\text{Ni}$	63.55 ${}_{29}\text{Cu}$	65.39 ${}_{30}\text{Zn}$	69.72 ${}_{31}\text{Ga}$	72.61 ${}_{32}\text{Ge}$	74.92 ${}_{33}\text{As}$	78.96 ${}_{34}\text{Se}$	79.90 ${}_{35}\text{Br}$	83.80 ${}_{36}\text{Kr}$
106.4 ${}_{46}\text{Pd}$	107.9 ${}_{47}\text{Ag}$	112.4 ${}_{48}\text{Cd}$	114.8 ${}_{49}\text{In}$	118.7 ${}_{50}\text{Sn}$	121.8 ${}_{51}\text{Sb}$	127.6 ${}_{52}\text{Te}$	126.9 ${}_{53}\text{I}$	131.3 ${}_{54}\text{Xe}$
195.1 ${}_{78}\text{Pt}$	197.0 ${}_{79}\text{Au}$	200.6 ${}_{80}\text{Hg}$	204.4 ${}_{81}\text{Tl}$	207.2 ${}_{82}\text{Pb}$	209.0 ${}_{83}\text{Bi}$	(210) ${}_{84}\text{Po}$	(210) ${}_{85}\text{At}$	(222) ${}_{86}\text{Rn}$
157.3 ${}_{64}\text{Gd}$	158.9 ${}_{65}\text{Tb}$	162.5 ${}_{66}\text{Dy}$	164.9 ${}_{67}\text{Ho}$	167.3 ${}_{68}\text{Er}$	168.9 ${}_{69}\text{Tm}$	173.0 ${}_{70}\text{Yb}$	175.0 ${}_{71}\text{Lu}$	
(247) ${}_{96}\text{Cm}$	(247) ${}_{97}\text{Bk}$	(252) ${}_{98}\text{Cf}$	(252) ${}_{99}\text{Es}$	(257) ${}_{100}\text{Fm}$	(258) ${}_{101}\text{Md}$	(259) ${}_{102}\text{No}$	(262) ${}_{103}\text{Lr}$	

1.4 Block classification of the periodic table and elements

Starting from hydrogen, over 100 elements are constituted as electrons are successively accommodated into $1s$, $2s$, $2p$, $3s$, $3p$, $4s$, and $3d$ orbitals one by one from lower to higher energy levels. When elements with similar properties are arranged in columns, the periodic table of the elements is constructed. The modern periodic table of the elements is based on one published by D. I. Mendeleev in 1892, and a variety of tables have since been devised. The long periodic table recommended by IUPAC is the current standard, and it has the group numbers arranged from Group 1 alkali metals through Group 18 rare gas elements (Table 1.1).

Based on the composition of electron orbitals, hydrogen, helium and Group 1 elements are classified as ***s*-block elements**, Group 13 through Group 18 elements ***p*-block elements**, Group 3 through Group 12 elements ***d*-block elements**, and lanthanoid and actinoid elements ***f*-block elements**. (Fig. 1.2). *s*-Block, *p*-block, and Group 12 elements are called **main group elements** and *d*-block elements other than Group 12 and *f*-block elements are called **transition elements**. The characteristic properties of the elements that belong to these four blocks are described in Chapter 4 and thereafter. Incidentally, periodic tables that denote the groups of *s*-block and *p*-block elements with Roman numerals (I, II, ..., VIII) are still used, but they will be unified into the IUPAC system in the near future. Since inorganic chemistry covers the chemistry of all the elements, it is important to understand the features of each element through reference to the periodic table.

1	2	3	4	5	6	7	8	9	10	11	12	13	14	15	16	17	18
H																	He
Li	Be											B					Ne
		transition elements															
		Sc									Zn						
		Ln									Hg	Tl					Rn
Fr	Ra	An	d-block									p-block					
s-block		La															Lu
		Ac															Lr
		f-block															

Fig. 1.2 Block classification of elements in the periodic table.

1.5 Bonding states of elements

Organic compounds are molecular compounds that contain mainly carbon and hydrogen atoms. Since inorganic chemistry deals with all compounds other than organic ones, the scope of inorganic chemistry is vast. Consequently, we have to study the syntheses, structures, bondings, reactions, and physical properties of elements, molecular compounds, and solid-state compounds of 103 elements. In recent years, the structures of crystalline compounds have been determined comparatively easily by use of single crystal X-ray structural analysis, and by through the use of automatic diffractometers. This progress has resulted in rapid development of new areas of inorganic chemistry that were previously inaccessible. Research on higher dimensional compounds, such as **multinuclear complexes, cluster compounds**, and solid-state inorganic compounds in which many metal atoms and ligands are bonded in a complex manner, is becoming much easier. In this section, research areas in inorganic chemistry will be surveyed on the basis of the classification of the bonding modes of inorganic materials.

(a) Element

Elementary substances exist in various forms. For example, helium and other rare gas elements exist as single-atom molecules; hydrogen, oxygen, and nitrogen as two-atom molecules; carbon, phosphorus, and sulfur as several solid allotropes; and sodium, gold, *etc.* as bulk metals. A simple substance of a metallic element is usually called **bulk metal**, and the word “metal” may be used to mean a bulk metal and “metal atom or metal ion” define the state where every particle is discrete. Although elementary substances appear simple because they consist of only one kind of element, they are rarely produced in pure forms in nature. Even after the discovery of new elements, their isolation often presents difficulties. For example, since the manufacture of ultra high purity silicon is becoming very important in science and technology, many new purification processes have been developed in recent years.

Exercise 1.2 Give examples of allotropes.

[Answer] carbon: graphite, diamond.

Phosphorus: white phosphorus, red phosphorus.

(b) Molecular compounds

Inorganic compounds of nonmetallic elements, such as gaseous carbon dioxide CO_2 , liquid sulfuric acid H_2SO_4 , or solid phosphorus pentoxide P_2O_5 , satisfy the valence

requirements of the component atoms and form discrete molecules which are not bonded together. The compounds of main group metals such as liquid tin tetrachloride SnCl_4 and solid aluminum trichloride AlCl_3 have definite molecular weights and do not form infinite polymers.

Most of the molecular compounds of transition metals are metal complexes and organometallic compounds in which ligands are coordinated to metals. These molecular compounds include not only **mononuclear complexes** with a metal center but also multinuclear complexes containing several metals, or cluster complexes having metal-metal bonds. The number of new compounds with a variety of bonding and structure types is increasing very rapidly, and they represent a major field of study in today's inorganic chemistry (refer to Chapter 6).

(c) Solid-state compounds

Although solid-state inorganic compounds are huge molecules, it is preferable to define them as being composed of an infinite sequence of 1-dimensional (chain), 2-dimensional (layer), or 3-dimensional arrays of elements and as having no definite molecular weight. The component elements of an inorganic solid bond together by means of ionic, covalent, or metallic bonds to form a solid structure. An ionic bond is one between electronically positive (alkali metals *etc.*) and negative elements (halogen *etc.*), and a covalent bond forms between elements with close electronegativities. However, in many compounds there is contribution from both ionic and covalent bonds (see Section 2.1 about bondings).

Exercise 1.3 Give examples of solid-state inorganic compounds.

[Answer] sodium chloride NaCl , silicon dioxide, SiO_2 , molybdenum disulfide, MoS_2 .

The first step in the identification of a compound is to know its elemental composition. Unlike an organic compound, it is sometimes difficult to decide the empirical formula of a solid-state inorganic compound from elemental analyses and to determine its structure by combining information from spectra. Compounds with similar compositions may have different coordination numbers around a central element and different structural dimensions. For example, in the case of binary (consisting of two kinds of elements) metal iodides, gold iodide, AuI , has a chain-like structure, copper iodide, CuI , a zinc blende type structure, sodium iodide, NaI , has a sodium chloride structure, and cesium iodide, CsI , has a cesium chloride structure (refer to Section 2.2 (e)), and the metal atoms are bonded to 2, 4, 6 or 8 iodine atoms, respectively. The minimum repeat unit of a solid structure is called a **unit lattice** and is the most fundamental

information in the structural chemistry of crystals. X-ray and neutron diffraction are the most powerful experimental methods for determining a crystal structure, and the bonds between atoms can only be elucidated by using them. **Polymorphism** is the phenomenon in which different kinds of crystals of a solid-state compound are obtained in which the atomic arrangements are not the same. Changes between different polymorphous phases with variations in temperature and/or pressure, or **phase transitions**, are an interesting and important problem in solid-state chemistry or physics.

We should keep in mind that in solid-state inorganic chemistry the elemental composition of a compound are not necessarily integers. There are extensive groups of compounds, called **nonstoichiometric compounds**, in which the ratios of elements are non-integers, and these non-stoichiometric compounds characteristically display conductivity, magnetism, catalytic nature, color, and other unique solid-state properties. Therefore, even if an inorganic compound exhibits non-integral stoichiometry, unlike an organic compound, the compound may be a thermodynamically stable, orthodox compound. This kind of compound is called a non-stoichiometric compound or **Berthollide compound**, whereas a stoichiometric compound is referred to as a **Daltonide compound**. The law of constant composition has enjoyed so much success that there is a tendency to neglect non-stoichiometric compounds. We should point out that groups of compounds in which there are slight and continuous changes of the composition of elements are not rare.

Problem 1.1 Express the isotopes of hydrogen, carbon, and oxygen using the symbols of the elements with atomic and mass numbers and write the number of protons, neutrons, and electrons in parenthesis.

Superheavy elements

The last element in the ordinary periodic table is an actinoid element lawrencium, Lr, ($Z = 103$). However, elements ($Z = 104 - 109$) "have already been synthesized" in heavy ion reactions using nuclear accelerators. These are *6d* elements which come under the *5d* transition elements from hafnium, Hf, to iridium, Ir, and it is likely that their electronic structures and chemical properties are similar. As a matter of fact, only the existence of **nuclides** with very short lives has been confirmed. The trouble of naming the super heavy elements is that the countries of their discoverers, the United States, Russia and Germany, have proposed different names. The tentative names of these elements are:

unnilquadium Une ($Z = 104$), unnilpentium Unp ($Z = 105$), unnilhexium Unh ($Z = 106$), unnilseptium Unq ($Z = 107$), unniloctium Uno ($Z = 108$) and unnilennium Une ($Z = 108$). It has recently been settled that they be named: Rutherfordium $_{104}\text{Rf}$, Dubnium $_{105}\text{Db}$, Seaborgium $_{106}\text{Sg}$, Bohrium $_{107}\text{Bh}$, Hassium $_{108}\text{Hs}$, and Meitnerium $_{109}\text{Mt}$.

"Synthesis" of the element ($Z = 110$), which should come under platinum, was considered the technical limit, but there is a recent report that even the element ($Z = 112$) "was synthesized". In any case, the superheavy elements will run out shortly. It is natural that complications are caused by naming of a new element, because it is a great honor for a scientist to have a new element named after him or her.

2 Bonding and Structure

Atomic radii, bond angles, and the valence electrons of the atoms or ions constituting compounds govern the bonding, structure, reactions, and physical properties of the compounds. It is desirable that the chemical properties of known and new compounds can be explained and predicted using universal parameters characteristic of the constituent elements. Inorganic chemistry has developed along with the discovery of new compounds and novel bonding modes. Therefore, it is important to understand the bonding modes, the geometrical and electronic factors governing the bonding, and to learn the basic concepts of molecular orbital theory.

2.1 Classification of bonding

The bond in which a pair of electrons bind atoms A and B is called a covalent bond, and it is written as A-B or A:B. Since two pairs of electrons are involved in a double bond and three pairs in a triple bond, they are designated by A=B, A≡B or A::B, or A:::B, respectively. The covalent bond is a simple but very useful concept proposed by G. N. Lewis at the beginning of this century and its representation is called the **Lewis structure**. Unshared pair of valence electrons are called lone pairs, and they are expressed by a pair of dots like A:

Exercise 2.1 Describe the Lewis structures of the nitrogen molecule N₂ and the oxygen molecule O₂.

[Answer] : N:::N: , : O::O :

Eight electrons are required to fill an *s* and three *p* orbitals, and when the total number of electrons used for the bonds and lone pairs is eight, a stable molecular structure results. This is called the **octet rule** and is useful when qualitatively discussing the molecular structures of main group compounds. Of course, this rule is not applied to a hydrogen molecule, H₂, but is applicable to covalent molecules, such as simple two-atomic molecules O₂ or CO and even to complicated organic compounds. For the

elements after the 3rd period, the number of covalent bonds is sometimes five (*e.g.* PCl_5) or six (*e.g.* SF_6), and the central atom of these molecules shows **hypervalency**. In this case, because *s* and *p* electrons run short to form more than four 2-electron covalent bonds, it was once believed that *d* electrons were partly involved. The present view is, however, that these hypervalent bonds use only *s* and *p* orbitals but that the bond orders are lower than those of single bonds.

The electrostatic bond between cations (positive ion) and anions (negative ion), such as in sodium chloride, NaCl , is called an ionic bond. Since the total electrical charge in a compound should be zero, the electrical charges of cations and anions are equal. There is a partial contribution from covalent bonds even in an ionic compound, and the ions are not necessarily bonded only by the electrostatic interaction.

Pauling's electroneutrality principle states that the net electrical charge of each component of a compound is essentially neutral. As will be mentioned later, the structures of many solid compounds are described as an alternate array of cations and anions, and are classified into several representative crystal types.

Metal atoms are bound together by means of the **conduction electrons** originating from the valence electrons of metal atoms. The bond due to the conduction electrons in a bulk metal is called the **metallic bond**.

Generally, chemical bonds can be assigned to either of the three kinds mentioned above, but new compounds have been synthesized one after another which cannot always be classified by the simple **2-center electron pair covalent bond**. They include **electron-deficient bonds** in boron hydrides, **coordinate bonds** in transition metal complexes, the **metal-metal bonds** in metal cluster compounds, *etc.*, and new concepts have been introduced into bond theory to account for these new kinds of chemical bonds. As has already been described, a weak bonding interaction called the **van der Waals interaction** has been recognized in neutral atomic or molecular compounds. The potential of this interaction is inversely proportional to the 6th power of the distance between atoms. The adjacent but non-bonded distance between atoms is estimated by the sum of the van der Waals radius assigned to each atom.

The weak interaction X-H-Y that a hydrogen atom forms with the atoms X, Y (nitrogen, oxygen, fluoride, *etc.*) with larger electronegativity than that of hydrogen is called the **hydrogen bond**. Hydrogen bonding plays an important role in ice, the structure of the double helix of DNA (deoxyribonucleic acid), *etc.*

2.2 Geometrical factors governing bonding and structure

Two parameters, radii and the electron attracting power of atoms or ions, determine

the bonding, structure, and reaction of elementary substances and compounds. Much effort has been devoted to finding numerical values for these two factors applicable to all materials. It is hoped that the chemical properties of a known compound, and of a still non-existent new material, can be predicted with a combination of suitable numerical values. Firstly, geometrical factors will be described.

Table 2.1 Atomic radii (pm)

H 32								
Li 123	Be 89							
Na 154	Mg 136							
K 203	Ca 174	Sc 144	Ti 132	V 122	Cr 118	Mn 117	Fe 117	Co 116
Rb 216	Sr 191	Y 162	Zr 145	Nb 134	Mo 130	Tc 127	Ru 125	Rh 125
Cs 235	Ba 198	La 169	Hf 144	Ta 134	W 130	Re 128	Os 126	Ir 127

			B 82	C 77	N 75	O 73	F 72
			Al 118	Si 111	P 106	S 102	Cl 99
Ni 115	Cu 117	Zn 125	Ga 126	Ge 122	As 120	Se 117	Br 114
Pd 128	Ag 134	Cd 148	In 144	Sn 140	Sb 140	Te 136	I 133
Pt 130	Au 134	Hg 149	Tl 148	Pb 147	Bi 146		

(a) Atomic and ionic radii

The electron density in atoms gradually approaches, but never reaches, zero as the distance from the nucleus increases. Therefore, strictly speaking the radius of an atom or ion is indeterminable. However, it is possible to determine the bond distance between atomic nuclei experimentally. Atomic radii determined experimentally are one of the most important atomic parameters describing the structural chemistry of compounds. It is reasonable to define the metal radius of a bulk metal as half of the distance between metal atoms. Half of the distance between atoms is defined also as the **covalent radius** of a

covalent elementary substance (Table 2.1).

Table 2.2 Ionic radii (in pm).*

Li ⁺ (4) 59	Be ²⁺ (4) 27	B ³⁺ (4) 11	N ³⁺ (6) 16	O ²⁻ (6) 140	F ⁻ (6) 133
Na ⁺ (6) 102	Mg ²⁺ (6) 72	Al ³⁺ (6) 54	P ³⁺ (6) 44	S ²⁻ (6) 184	Cl ⁻ (6) 181
K ⁺ (6) 138	Ca ²⁺ (6) 100	Ga ³⁺ (6) 62	As ³⁺ (6) 58	Se ²⁻ (6) 198	Br ⁻ (6) 196
Rb ⁺ (6) 152	Sr ²⁺ (6) 118	In ³⁺ (6) 80		Te ²⁻ (6) 221	I ⁻ (6) 220
Cs ⁺ (6) 167	Ba ²⁺ (6) 135	Tl ³⁺ (6) 89			

*Numbers in parentheses are the coordination number of the ions.

Since the cations and anions of different elements in an ionic compound are bonded by electrostatic interactions, the bond distance is the sum of **ionic radii** assigned to the cation and anion. The standard ionic radius of one species is fixed first and is then subtracted from the distance between ions to decide the radius of the partner ion. As the standard, the radius of O²⁻ ion in a number of oxides is set to 140 pm (1 pm = 10⁻¹² m) (R. D. Shannon). Cationic radii in oxides are the difference between the bond distance and 140 pm. After cation radii in oxides are decided, other anion radii can be calculated by subtraction of the cation radii from the distances between the atoms in ionic compounds. By applying such methods to many ionic compounds, ionic radii have been compiled in such a way that experimental and calculated values are generally consistent (Table 2.2).

Even ionic compounds have some covalent contribution and it is not expected that calculated and experimental bond distances will agree exactly. Even if the ionic radius assigned to a standard ion is changed, we can still compile a set of ionic radii that are consistent across many compounds. Other examples of the proposed radii of O²⁻ ion are 132 pm (V. M. Goldschmidt) or 60 pm (J. C. Slater). We must also be mindful that the cation-anion distances of the same ion pair become larger as the **coordination number** of opposite ions increases. Therefore, in any discussion of the structural features of ionic compounds from a viewpoint of ionic radii, a set of the ionic radii calculated using the same standard radius for the compounds with the same coordination number should be used.

Exercise 2.2 Which ionic radius is larger, Cs⁺ or F⁻?

[Answer] Cs⁺(167 pm) > F⁻(133 pm). The anion radius is not always larger.

The metal and covalent radii, also called the **atomic radii**, become smaller in the same period of the periodic table as the group of the element goes to the right and then increase again in the next period. The **lanthanide contraction** is responsible for the 5th period (*4d*) elements having almost the same atomic radii as those of the 6th period (*5d*) ones. In the periodic table, the lanthanide elements are inserted before the *5d* elements. The atomic radii of lanthanide elements decrease noticeably as the effective nuclear charge increases because the screening effects of the *4f* orbitals of lanthanide elements are weak due to their orbital shapes. Consequently, the atomic radii of the elements following lanthanides are very similar to those of the *4d* elements.

(b) Lattice enthalpy

Although the stability of a crystal at constant temperature and pressure depends on the Gibbs free energy change of the crystal's formation from its constituent ions, the stability of a crystal is determined mostly by the enthalpy change alone since the lattice formation is very exothermic, and the entropy term is negligibly small (refer to Section 3.1). **Lattice enthalpy**, ΔH_L , is defined as the standard enthalpy change of the reaction in which an ionic crystal decomposes into gaseous ions (s is solid, g is gas and L is lattice).

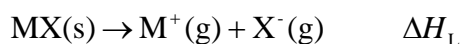

Lattice enthalpy is indirectly calculated from the values of the enthalpy change at each stage using a Born-Haber cycle (Fig. 2.1). Namely, a closed cycle is formed using enthalpy data; standard enthalpy of formation ΔH_f of an ionic crystal from elements, sublimation enthalpy of an elementary solid, or atomization enthalpy ΔH_{atom} corresponding to the dissociation enthalpy of a gaseous elementary molecule, the ionization enthalpy ΔH_{ion} , which is the sum of the ionization enthalpy of cation formation and electron acquisition enthalpy of anion formation. Lattice enthalpy is calculated using the relation that enthalpy change in a cycle is zero.

$$\Delta H_{\text{atom}}^0 + \Delta H_{\text{ion}}^0 - \Delta H_L^0 - \Delta H_f^0 = 0$$

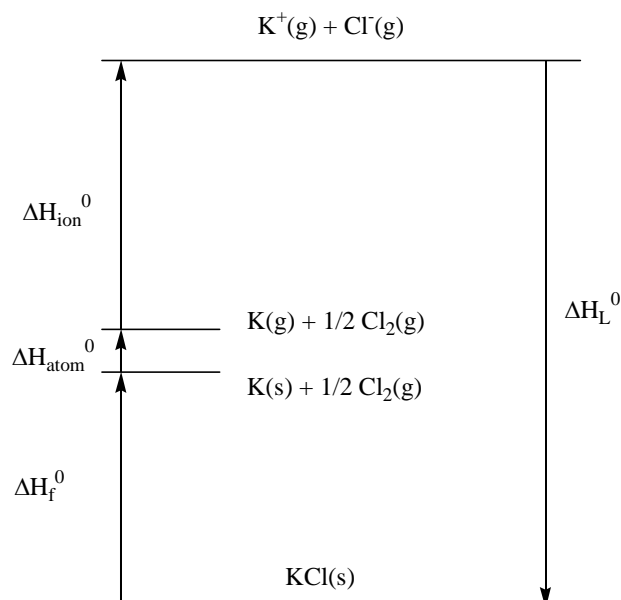

Fig. 2.1 Born-Haber cycle of KCl.

(c) Madelung constant

The total Coulomb potential energy that exists between the ions in an ionic crystal consisting of ions A and B should be the sum of the individual Coulomb potential energies V_{ab} . Since the locations of the ions in the crystal lattice are decided by the structure type, the total Coulomb potential between all ions is calculated by setting the distance between the ions to d . A is the **Madelung constant** that is characteristic of each crystal type (Table 2.3).

$$V = N_A \frac{e^2}{4\pi\epsilon_0} \left(\frac{z_A z_B}{d} \right) \times A$$

N_A is Avogadro's constant and z_A and z_B are the electric charges of the cation and anion. The electrostatic interaction between contiguous ions is the strongest, and the Madelung constant generally becomes larger as the coordination number increases. Because the electrical charges have opposite signs, the potential becomes negative, indicating the stabilization that accompanies the formation of a crystal lattice from well dispersed,

gaseous phase ions. Although it is generally true that the lowest electrostatic potential leads to the most stable structure, this is not strictly correct since there are also other interactions to consider.

Table 2.3 Madelung constants

Structural type	A
Rock-salt	1.748
Cesium chloride	1.763
Sphalerite	1.638
Wurtzite	1.641
Fluorite	2.519
Rutile	2.408

The second largest factor that contributes to the lattice enthalpy is the van der Waals force, and **dispersion forces** or the **London interaction** is the main origin of this force. It is an attractive interaction between electric dipoles, which is inversely proportional to the 6th power of the distance d between ions. The van der Waals force is very small.

$$V = -\frac{N_A C}{d^6}$$

The value of the constant C is a function of each compound. Since it is at most 1% of the Coulombic force, it may be safely neglected in the calculation of lattice enthalpy.

(d) Structure of metal crystals

If we imagine metal atoms as being hard balls, when densely packed in two dimensions each ball will be in contact with six other balls (A). When another layer of this 2 dimensional arrangement is placed on top of the first, the packing will be densest and the structure most energetically stable when the metal atoms are placed on top of the hollows (B) of the first layer. When a 3rd layer is placed on top of the 2nd layer, there are two possibilities. Namely, the 3rd layer (A) overlaps with the 1st layer (A) or the 3rd layer (C) overlaps with neither (A) nor (B). The ABAB...-type packing is called **hexagonally close-packed** (hcp) (Fig. 2.2), and the ABCABC...-type is called **cubic close-packed** (ccp) (Fig. 2.3). In both cases, each ball is surrounded by 12 balls, that is, it is 12-coordinated. The coordination polyhedron of hcp is anti-cubooctahedron,

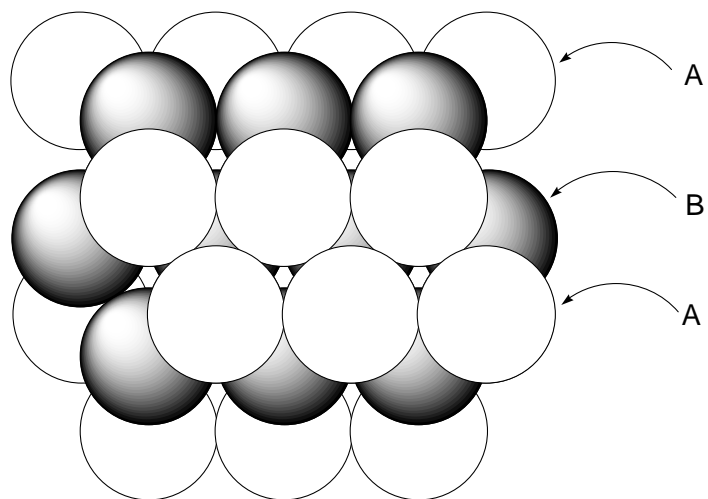

Fig. 2.2 Hexagonally close-packed (hcp) of balls.

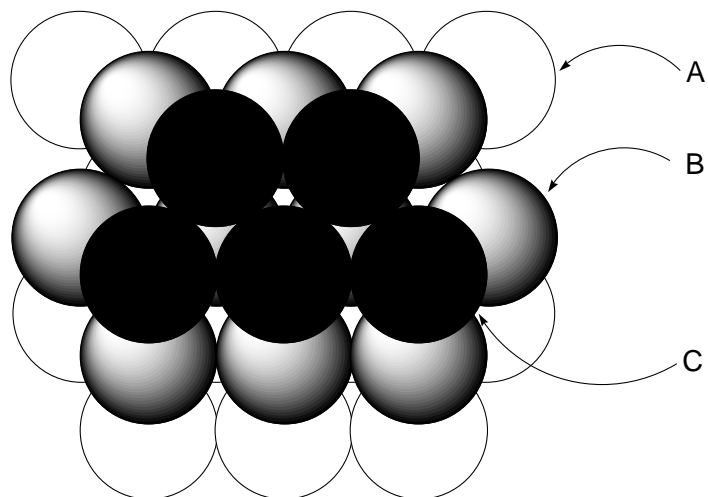

Fig. 2.3 Cubic close-packed (ccp) of balls.

and that of ccp is cubooctahedron. When the lattice is sliced in different planes, the unit lattice of ccp appears to be a **face-centered cubic lattice** (fcc), containing a ball at each cubical apex and on the center of each face (Fig. 2.4). The unit lattice of hcp is a rhombohedral prism in which two balls are located in the positions shown in (Fig. 2.5). There are several different modes of piling up layers other than the normal hcp and ccp,

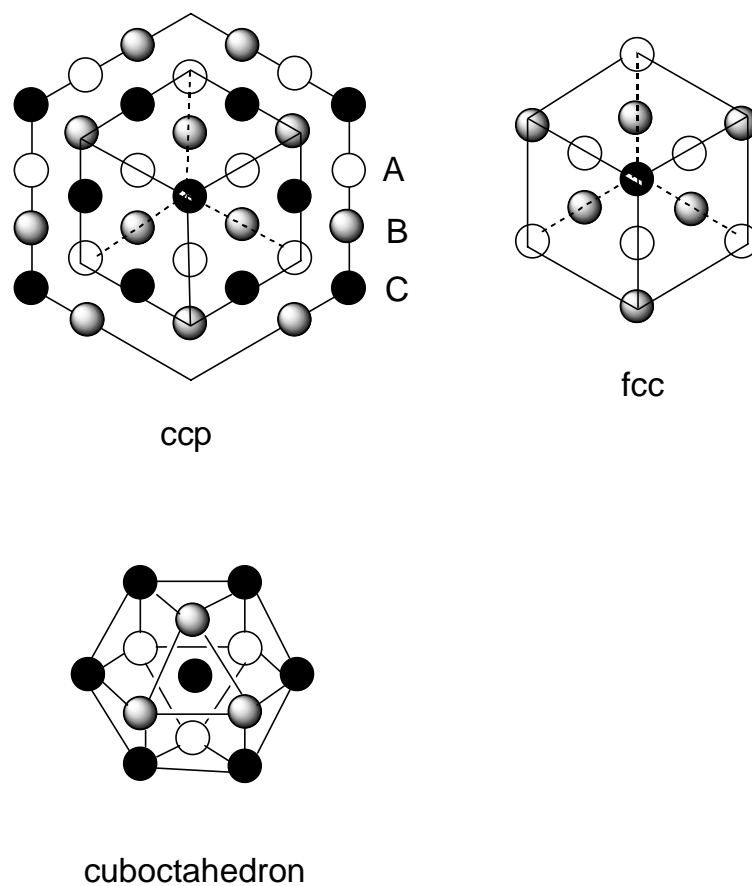

Fig. 2.4 Different expressions of cubic close-packed.

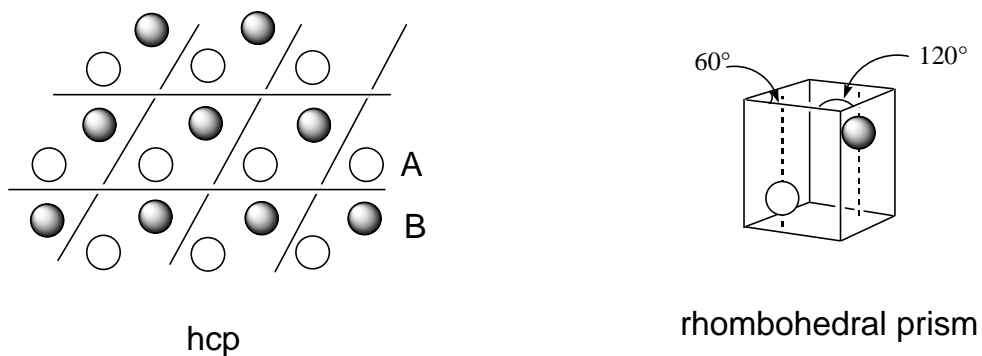

Fig. 2.5 Different expressions of hexagonally close-packed.

and many examples are known.

The lattice with another ball at the center of a cubic lattice consisting of eight balls is the **body centered cubic lattice** (bcc), and some metals assume this mode of packing.

The ratio of space occupation in a bcc lattice is smaller than that of close-packed ones but the difference is not large. Although the central ball is formally 8-coordinated, it is essentially 14-coordinated since there are a further six balls only 15.5% more distant than the first eight balls. However, because of the smaller ratio of space occupation, bcc appears relatively rarely and pure metals tend to adopt hcp or ccp.

In both hcp and ccp, the cavities among the balls are either the O_h holes enclosed octahedrally by six balls or the T_d holes enclosed tetrahedrally by four balls (Fig. 2.6). (O_h and T_d are the symmetry symbols used in group theory.) In ionic solids, if the anions are in hcp or ccp arrangements, cations enter into either of these cavities.

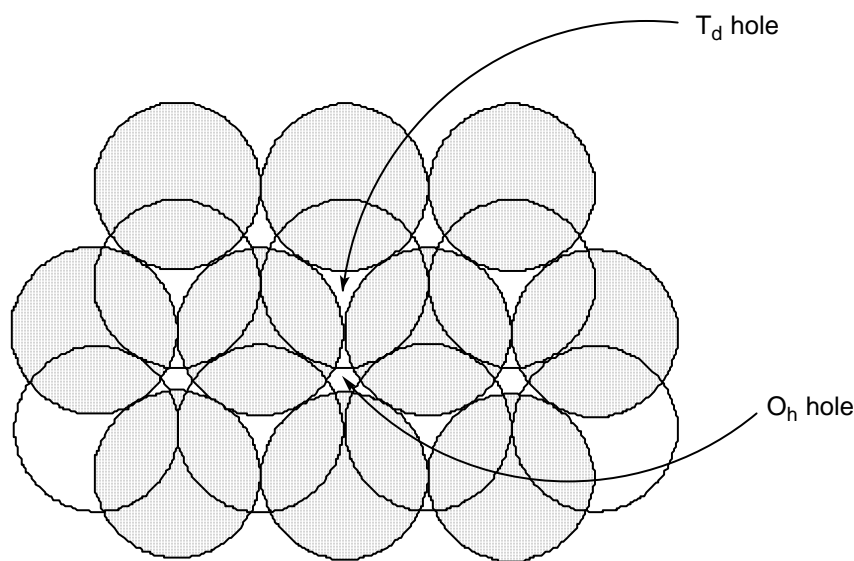

Fig. 2.6 Octahedral and tetrahedral holes.

(e) Ionic crystal

In ionic crystals, such as metal halides, oxides, and sulfides, metal cations and anions are aligned alternately, and the solid is bound together mainly by electrostatic bonding. Many metal halides dissolve in polar solvents, *e.g.* sodium chloride NaCl dissolves in water; whereas metal oxides and sulfides, in which there is a significant contribution of covalent bonding, are usually insoluble even in the most polar of solvents. The fundamental structure of ionic crystals is that larger ions (usually anions) are close-packed and smaller ions (usually cations) enter into the octahedral or tetrahedral cavities between them. Ionic crystals are classified into several typical structures according to the kinds of cations and anions involved and their ionic radii. Each structure type is called by the name of the typical compound, just as the rock salt structure representing the structures of not only NaCl (rock salt) but also various other compounds.

Representative structure types of solid compounds and examples belonging to each type are shown in Table 2.4.

Table 2.4 Crystal types of solid-state compounds

Crystal type	Coordination number	Examples of compounds
Rock-salt	(6,6)	LiCl, NaCl, KBr, RbI, AgCl, MgO, NiO, InP
Cesium chloride	(8,8)	CsCl, CsBr, CsI, CuZn
Sphalerite	(4,4)	ZnS, CdS, HgS, CuCl, GaP
Fluorite	(8,4)	CaF ₂ , SrF ₂ , CdF ₂ , ZrO ₂ , UO ₂
Rutile	(6,3)	TiO ₂ , SnO ₂ , RuO ₂ , NiF ₂
Cadmium iodide	(6,3)	CdI ₂ , CoI ₂ , Mg(OH) ₂
Rhenium oxide	(6,2)	ReO ₃ , WO ₃ , Sc(OH) ₃
Perovskite	(6,2)	CaTiO ₃ , BaTiO ₃ , SrTiO ₃

Rock-salt structure Sodium chloride NaCl is a typical compound in which Cl⁻ anions are arranged in ccp and Na⁺ cations occupy all the octahedral holes (O_h holes) (Fig. 2.7). Each Na⁺ cation is surrounded by six Cl⁻ anions. The same structure results even if the positions of anions and cations are exchanged. In the case of the reversed structure, each Cl⁻ anion is surrounded by six Na⁺ cations. Namely, each ion is 6-coordinated and it is convenient to describe the structure as the (6,6)-structure. The number of ions in a unit lattice is calculated by summing up the ions shown in Fig. 2.7. Since there is one ion inside the lattice, the ions on the faces of the lattice are shared by 2, on the edges by 4, and on the corners by 8 lattices, a net of 4 Cl ions belonging to the unit lattice of NaCl is obtained by multiplying the numbers of ions inside the lattice by 1, on the faces by 1/2, on the edges by 1/4 and on the corners by 1/8. The number of Na ions in the unit lattice is also 4 and the ratio of Cl and Na ions agrees with the formula NaCl.

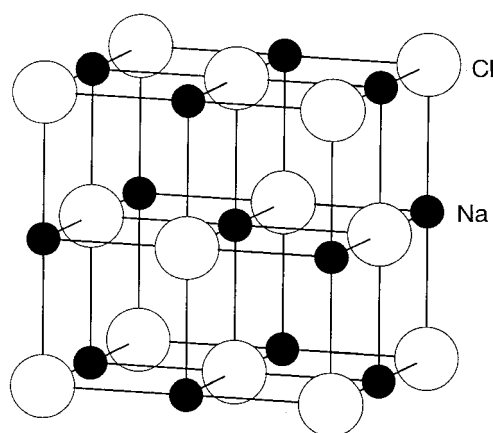

Fig. 2.7 Rock-salt structure.

Cesium chloride structure Cesium chloride, CsCl , is a typical example of the structure shown in Fig. 2.8. There is a Cs^+ ion at the center and eight Cl^- are located at the eight corners of the cube. Conversely, even if a Cl^- comes to the center and eight Cs^+ come to the corners, the number of each ion in the unit lattice is the same. Thus, this is referred to as the (8, 8)-structure. Since there is one Cs^+ and one Cl^- ion belonging to this unit lattice, it coincides with the formula CsCl .

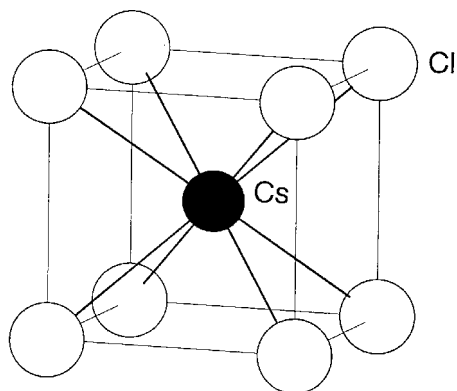

Fig. 2.8 Cesium chloride structure.

Zinc blende structure Zinc blende has the composition ZnS and its unit lattice is shown in Fig. 2.9. S^{2-} anions are arranged in ccp and Zn^{2+} cations occupy half of the tetrahedral holes (T_d holes). In this arrangement, each cation is coordinated by four anions, and each anion by four cations. Hence, this is a (4, 4)-structure. There are both four Zn^{2+} and S^{2-} ions belonging to this unit lattice and the atomic ratio coincides with the formula of ZnS .

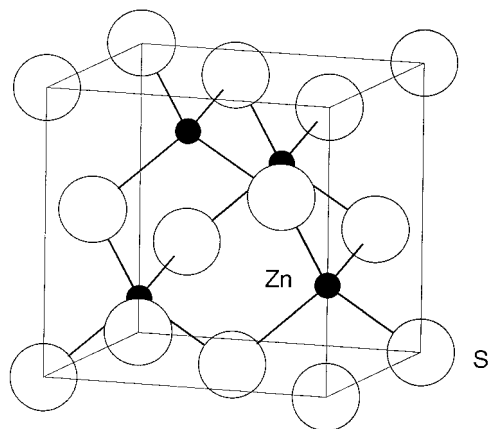

Fig. 2.9 Zinc blende structure.

Fluorite structure The composition of fluorite is CaF_2 . Since the number of F⁻ is twice that of Ca^{2+} , all the tetrahedral holes of Ca^{2+} arranged in ccp are occupied by F⁻, as shown in Fig. 2.10. There are four Ca^{2+} and eight F⁻ ions and the number of ions is 4 times the formula. The anti-fluorite structure exchanges the cations and anions, and is exemplified by potassium oxide K_2O , *etc.*

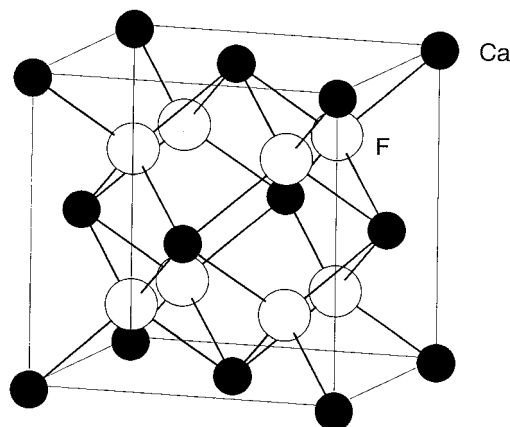

Fig. 2.10 Fluorite structure.

Exercise 2.3 How many cations and anions are there in a unit lattice of zinc blende structure?

[Answer] All four cations are included in a unit lattice. The anions occupy the 8 corners and 6 faces and the number is $8 \times 1/8 + 6 \times 1/2 = 4$.

(f) Radius ratio

Generally, the total Coulombic potential energy E_c of the univalent ionic compound MX is expressed by the following formula.

$$E_c = -\frac{N_A e^2}{4\pi\epsilon_0 R} A$$

N_A is the Avogadro constant, A the Madelung constant and R the distance between ions. According to this formula, a structure with a larger A / R ratio is more stable. The Madelung constant of an MX compound increases with increasing coordination number. On the other hand, it is advantageous to lower the coordination number and to reduce R in the case of small M, rendering contact between M and X more difficult. In an ionic crystal, the ratio of r_M and r_X with the anions contacting each other and also with the

cations depends on the coordination number.

In a partial structure consisting only of anions, the anions form a coordination polyhedron around a cation. The anionic radius r_X is one half of the distance of the edge of the polyhedron and the distance from the cation center to an apex of the polyhedron is the sum of the anion and cation radii $r_X + r_M$. The coordination polyhedron of the CsCl structure is a cube, the NaCl structure an octahedron, and the ZnS structure a tetrahedron.

The distance from the center of each polyhedron to an apex is $\sqrt{3}r_X, \sqrt{2}r_X, \frac{\sqrt{6}}{2}r_X$.

Therefore, the ratios of the cationic and anionic radii r_M / r_X are

$(\sqrt{3}r_X - r_X) / r_X = \sqrt{3} - 1 = 0.732$ for CsCl, $(\sqrt{2}r_X - r_X) / r_X = \sqrt{2} - 1 = 0.414$ for NaCl,

and $\left(\frac{\sqrt{6}}{2}r_X - r_X \right) / r_X = \sqrt{6} / 2 - 1 = 0.225$ for ZnS structures (Fig. 2.11).

It has been explained that the coordination number decreases when these radius ratios are smaller than the given values since cations and anions do not come into contact with each other, causing instability. On the other hand, the coordination number increases for larger cations, increasing the radius ratio. However, the relation between a coordination number and a radius ratio is not simple. For example, halides of alkali metals adopt the NaCl structures at normal temperatures except cesium chloride CsCl, cesium bromide CsBr and cesium iodide CsI. It is not possible to assume structure types from the radius ratios even in the case of simple ionic compounds like alkali metal halides. However, the qualitative trend that smaller cations have smaller coordination numbers is generally correct.

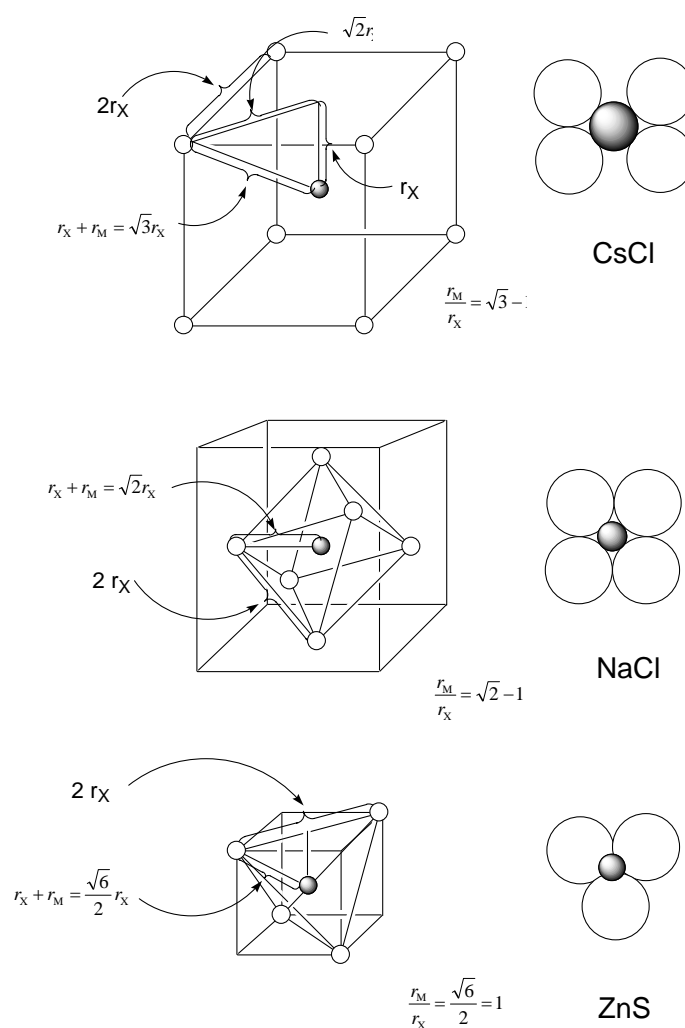

(g) Variation of the solid structure expression

Many solid-state inorganic compounds have complicated three-dimensional structures. Different structural illustrations for the same compound help our understanding of its structure. In the case of complicated inorganic compounds, drawing bond lines between atoms, as in most organic compounds, causes confusion. The anions in many metal oxides, sulfides, or halides form tetrahedra or octahedra around the central metal cations. Although there is no bond between anions, the structures are greatly simplified if they are illustrated by the anion polyhedra sharing apexes, edges, or faces. In such illustrations, cationic metal atoms are usually omitted. As has been mentioned, ionic solid structures can be thought of as a close packed arrays of anions.

Figures 2.12 and 2.13 illustrate these three representations for molecular phosphorus pentoxide $P_2O_5 (= P_4O_{10})$ and molybdenum pentachloride $MoCl_5 (= Mo_2Cl_{10})$.

Polyhedral representations are much easier to understand for the structures of large molecules or solid-state compounds formed by an infinite number of atoms. However, the bond line representation is suitable for molecular compounds such as the above examples.

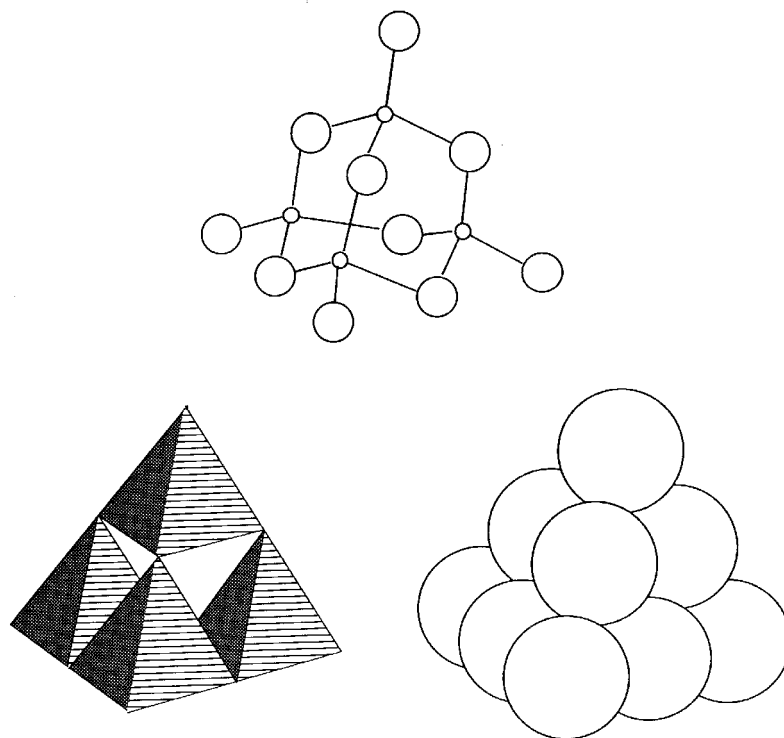

Fig. 2.12 Three expressions for the structure of P_4O_{10} .

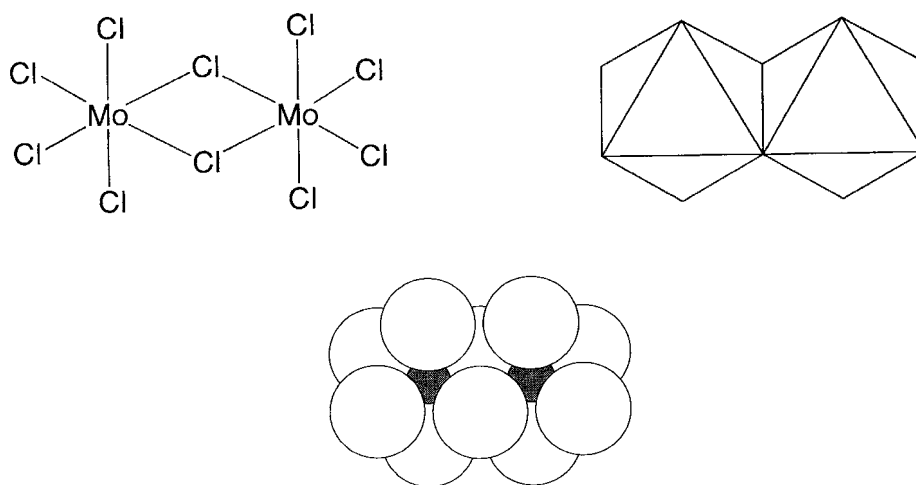

Fig. 2.13 Three expressions for the structure of Mo_2Cl_{10} .

2.3 Electronic factors which govern bonding and structure

The bonding and structure of a compound are determined by electronic properties such as the power of constituent atoms to attract or repel electrons, the molecular orbitals occupied by valence electrons, *etc.* Geometrical arrangements of atoms are also influenced by the electronic interactions between non-bonding electrons. Here, some fundamental concepts are described.

(a) Effective nuclear charge

Since the positive nuclear charge is generally offset by the negative charge of the internal electrons in the electron shell inside the valence electrons, the nuclear charge that valence electrons feel is smaller than the integer charge, Ze for an atomic number Z . This reduction is expressed by the **shielding constant** σ , and the net nuclear charge is called the **effective nuclear charge**, $Z_{\text{eff}}e$.

$$Z_{\text{eff}} = Z - \sigma$$

The effective nuclear charge varies with different electron orbitals and distances from the nucleus.

(b) Ionization energy

Ionization energy is defined as the minimum energy required to remove an electron from the atom in a gaseous phase (g), as shown in the following equation. Ionization energy is expressed in units of electron volt (eV), where $1\text{eV} = 96.49\text{ kJ mol}^{-1}$.

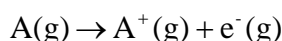

The 1st ionization energy, which removes the outermost electron, is the smallest, and the 2nd and 3rd ionization energies, which further ionize cations, increase rapidly. The ionization enthalpy, which is the standard enthalpy change of the ionization process and is used in thermodynamic calculations, is the ionization energy multiplied by RT (R is the universal gas constant $8.31451\text{ JK}^{-1}\text{ mol}^{-1}$ and T is temperature, 2.479 kJ (0.026 eV), at room temperature). The difference between these two parameters is small. The 1st ionization energy varies periodically with atomic number across the periodic table, with the lower left (cesium, Cs) being the smallest and the upper right (helium, He) the largest.

It is understandable that alkali metals generally have the lowest ionization energies because they are stabilized by removal of an s electron to attain the rare gas configuration. Rare gas elements have stable electronic structures, and their ionization energies are the largest. Although the ionization energy increases almost monotonically from alkali

metals to rare gases in each period, there are reversals at several places, such as nitrogen N and oxygen O, and phosphorus P and sulfur S. The 1st ionization energies are given in Table 2.5.

Table 2.5 Electronic parameters of atoms (eV). *I*: 1st ionization energy, A_e : electron affinity, χ_M : electronegativity (Mulliken)

atom	<i>I</i>	<i>A</i>	χ	atom	<i>I</i>	<i>A</i>	χ	atom	<i>I</i>	<i>A</i>	χ
H	13.60	0.75	7.18	Cr	6.77	0.67	3.72	Cd	8.99		
He	24.59			Mn	7.44			In	5.79	0.30	3.10
Li	5.39	0.62	3.01	Fe	7.90	0.15	4.03	Sn	7.34	1.11	4.23
Be	9.32			Co	7.88	0.66	4.27	Sb	8.64	1.07	4.86
B	8.30	0.28	4.29	Ni	7.64	1.16	4.40	Te	9.01	1.97	5.49
C	11.26	1.27	6.27	Cu	7.73	1.24	4.48	I	10.45	3.06	6.76
N	14.53			Zn	9.99			Xe	12.13		
O	13.62	1.46	7.54	Ga	6.00	0.30	3.20	Cs	3.89	0.47	2.18
F	17.42	3.40	10.41	Ge	7.90	1.23	4.61	Ba	5.21	0.15	2.68
Ne	21.56			As	9.82	0.81	5.31	La	5.58	0.50	3.09
Na	5.14	0.55	2.85	Se	9.75	2.02	5.89	Hf	6.83	0.00	3.42
Mg	7.65			Br	11.81	3.36	7.59	Ta	7.89	0.32	4.11
Al	5.99	0.44	3.22	Kr	14.00			W	7.98	0.82	4.40
Si	8.15	1.39	4.77	Rb	4.18	0.49	2.34	Re	7.88	0.15	0.40
P	10.49	0.75	5.62	Sr	5.69	0.11	2.90	Os	8.70	1.10	4.90
S	10.36	2.08	6.22	Y	6.22	0.31	3.27	Ir	9.10	1.60	5.40
Cl	12.97	3.61	8.29	Zr	6.63	0.43	3.53	Pt	9.00	2.13	5.61
Ar	15.76			Nb	6.76	0.89	3.83	Au	9.23	2.31	5.77
K	4.34	0.50	2.42	Mo	7.09	0.75	3.92	Hg	10.44		
Ca	6.11	0.02	3.07	Ru	7.36	1.05	4.26	Tl	6.11	0.20	3.16
Sc	6.56	0.19	3.38	Rh	7.46	1.14	4.30	Pb	7.42	0.36	3.89
Ti	6.83	0.08	3.45	Pd	8.34	0.56	4.45	Bi	7.29	0.95	4.12
V	6.75	0.53	3.64	Ag	7.58	1.30	4.44				

(c) Electron affinity

Electron affinity is the negative of the electron-gain enthalpy ΔH_{eg} of an atom in a gas phase, as shown in the following equation and denoted by A_e ($= -\Delta H_{eg}$) (Table 2.5).

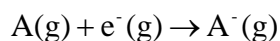

It may be regarded as the ionization enthalpy of an anion. Since halogen atoms achieve rare gas electron configurations if an electron is added to them, their electron affinities are large.

(d) Electronegativity

Electronegativity is one of the most fundamental atomic parameters which expresses numerically the tendency to attract electrons to atoms in a molecule. It is very useful in explaining differences in bonding, structure, and reaction from the standpoint of atomic properties. Various schemes have been proposed to explain the theoretical basis of the power of electron attraction, and studies are still actively seeking new numerical values of electronegativity. The Pauling scale, introduced first in 1932, is still the most frequently used, and subsequent new numerical values have been justified if they are close to those of Pauling.

L. Pauling defined electronegativity as the quantitative ionic character of bonds. Originally, the following equation was proposed as a formula to define the ionic character of the bond between atoms A and B.

$$\Delta = D(AB) - \frac{1}{2}(D(AA) + D(BB))$$

where D is the bond energy of a covalent bond. However, it turned out that Δ is not necessarily positive, and Pauling modified the definition

$$\Delta = D(AB) - \sqrt{D(AA) \times D(BB)}$$

and redefined it as the ionic character of the A-B bond. Furthermore, electronegativity χ was defined in such a way that the difference of the electronegativities of atoms A and B is proportional to the square root of the ionic character. Here, the coefficient

$$|\chi_A - \chi_B| = 0.208\sqrt{\Delta}$$

0.208 is so determined that the electronegativity of hydrogen H becomes 2.1 when bond energies are expressed in kcal mol^{-1} . Since Pauling electronegativities increase the higher the oxidation states of an atom, these values correspond to the highest oxidation number of each element. The electronegativities calculated using recent values of bond energies are shown in Table 2.6.

Table 2.6 Pauling electronegativities

	1	2	3	4	5	6	7	8	9
1	H 2.2								
2	Li 0.98	Be 1.57							
3	Na 0.93	Mg 1.31							
4	K 0.82	Ca 1.00	Sc 1.36	Ti 1.54	V 1.63	Cr 1.66	Mn 1.55	Fe 1.83	Co 1.88
5	Rb 0.82	Sr 0.95	Y 1.22	Zr 1.33	Nb 1.6	Mo 2.16	Tc 1.9	Ru 2.2	Rh 2.28
6	Cs 0.79	Ba 0.89	Lanthanoid	Hf 1.3	Ta 1.5	W 2.36	Re 1.9	Os 2.2	Ir 2.20
7	Fr 0.7	Ra 0.9	Actinoid						

10	11	12	13	14	15	16	17	18
								He
			B 2.04	C 2.55	N 3.04	O 3.44	F 3.98	Ne
			Al 1.61	Si 1.90	P 2.19	S 2.58	Cl 3.16	Ar
Ni 1.91	Cu 2.0	Zn 1.65	Ga 1.81	Ge 2.01	As 2.18	Se 2.55	Br 2.96	Kr 3.0
Pd 2.20	Ag 1.93	Cd 1.69	In 1.78	Sn 1.96	Sb 2.05	Te 2.10	I 2.66	Xe 2.6
Pt 2.28	Au 2.54	Hg 2.00	Tl 2.04	Pb 2.33	Bi 2.02	Po 2.0	At 2.2	Rn

A. L. Allred and E. G. Rochow defined electronegativity as the electric field Z_{eff} / r^2 on the atomic surface. They added a constant in order to make the electronegativity χ_{AR} as near as possible to the Pauling values by using r for the covalent bond radius of atoms.

$$\chi_{\text{AR}} = 0.74 + 0.36 \frac{Z_{\text{eff}}}{r^2}$$

It turns out that elements with small covalent radii and large effective nuclear charges have large electronegativities (Table 2.6).

R. Mulliken defined electronegativity χ_M as the average of the ionization energy I and electron affinity A_e as follows (Fig. 2.14).

$$\chi_M = \frac{1}{2}(I + A_e)$$

As ionization energy is the energy of electronic excitation from the HOMO and electron affinity the energy of electron addition to the LUMO (refer to Section 2.3 (e)), in this definition electronegativity can also be called the average value of the energy levels of the HOMO and LUMO. Those elements which are hard to ionize and easy to attract electrons have large values. Although the electronegativity is defined for the atoms in a valence state in a molecule and has the dimensions of energy, it is treated as a dimensionless number (Table 2.5).

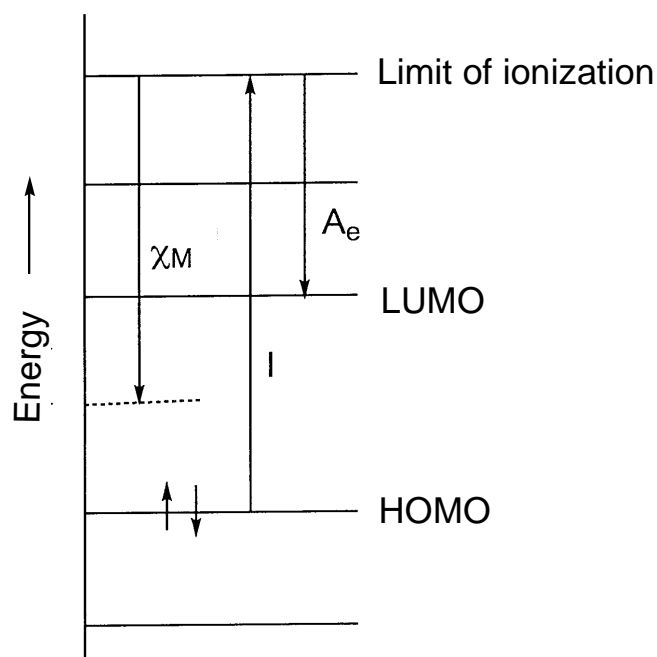

Fig. 2.14 Mulliken electronegativity.

Although the definition of Mulliken is intelligible since it is directly related to atomic orbitals, generally the values of Pauling or Allred-Rochow are used. As these values are not much different, the Pauling electronegativity is appropriate when choosing only one. Electronegativity values change not only by definition, but are also considerably affected by the bonding state of atoms, and they should be used with considerable caution. The electronegativities of the constituent atoms are fundamental to

explaining the differences in bonding, structure, and reactions of compounds. Therefore theoretical chemists continue in their efforts firmly to extend the foundations of this parameter.

Exercise 2.4 Describe the numerical tendency of electronegativities of the elements in the periodic table.

[Answer] They increase toward the right and decrease down the table. Namely, the electronegativity of alkali metal Cs is the smallest and that of fluorine F is the largest.

(e) Molecular orbitals

The wave functions of electrons in an atom are called **atomic orbitals**. Since the probability of finding electrons in a molecular orbital is proportional to the square of a wave function, the electron map looks like a wave function. A wave function has domains of positive and negative amplitude called lobes. The overlapping positive lobes or negative lobes of the wave functions of atoms in a molecule amplify each other to form a bond, but the positive and negative lobes cancel each other forming no bond. The extent of this interference effect corresponds to the magnitude of the overlap integral in quantum chemistry.

In the formation of a molecule, atomic orbitals overlap to generate a **molecular orbital** which is the wave function of the electrons in the molecule. The number of molecular orbitals is the sum of the atomic orbitals and these molecular orbitals are classified into **bonding, nonbonding, or antibonding molecular orbitals** by the extent of their participation in the bond between atoms. The conditions of the formation of a bonding molecular orbital are as follows.

[Conditions of the formation of bonding molecular orbitals]

- (1) The lobes of the atomic orbitals of the constituent atoms are suitable for an overlap.
- (2) The positive or negative sign of the overlapping lobes is the same.
- (3) The energy levels of atomic orbitals are close.

The simplest case where a molecular orbital is constructed from atomic orbitals A and B is explained here. A bonding molecular orbital is formed between A and B if the above mentioned conditions (1), (2), and (3) are satisfied, but if the sign of one of the atomic orbitals is reversed, condition (2) is not satisfied and an antibonding molecular orbital, in which the signs of the overlapping lobes are different (Fig. 2.15) results. The energy level of a bonding orbital is lower and the level of an antibonding orbital is higher

than those of the constituent atomic orbitals. The larger the energy difference of a bonding and an antibonding orbital, the stronger the bond. When there is no bonding or antibonding interaction between A and B, the resultant molecular orbital is a nonbonding orbital. Electrons occupy the molecular orbitals in order of lowest to highest energy levels. The highest occupied molecular orbital is called the **HOMO** and the lowest unoccupied one the **LUMO**. Ken'ichi Fukui (1981 Nobel prize) named these orbitals **frontier orbitals**.

Two or more molecular orbitals of equal energy are called **degenerate orbitals**. The symbol of a nondegenerate orbital is *a* or *b*, a doubly degenerate orbital *e*, and triply degenerate orbital *t*. The symbol *g* (gerade) is attached as a suffix to the centrosymmetric orbital and *u* (ungerade) to the orbital which changes sign under inversion around an inversion center. The number before the symmetry symbol is used in order of energy to distinguish orbitals of the same degeneracy. Additionally, they are named **sigma(σ) or**

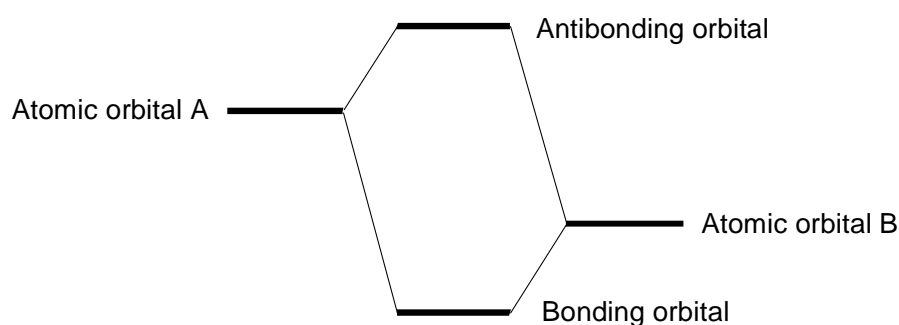
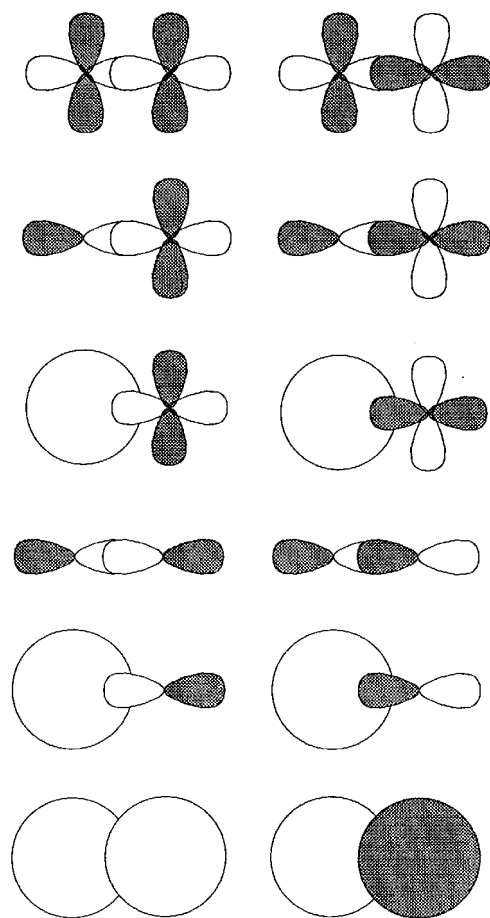

Fig. 2.15 Construction of molecular orbitals.

pi(π) orbitals according to the orbital character. A sigma orbital has rotation symmetry around the bond axis, and a pi orbital has a nodal plane. Therefore, sigma bonds are formed by the overlap of *s-s*, *p-p*, *s-d*, *p-d*, and *d-d* orbitals (Fig. 2.16) and pi bonds the overlap of *p-p*, *p-d*, and *d-d* orbitals (Fig. 2.17).



Bonding σ orbital Antibonding σ^* orbital

Fig. 2.16 The σ molecular orbitals.

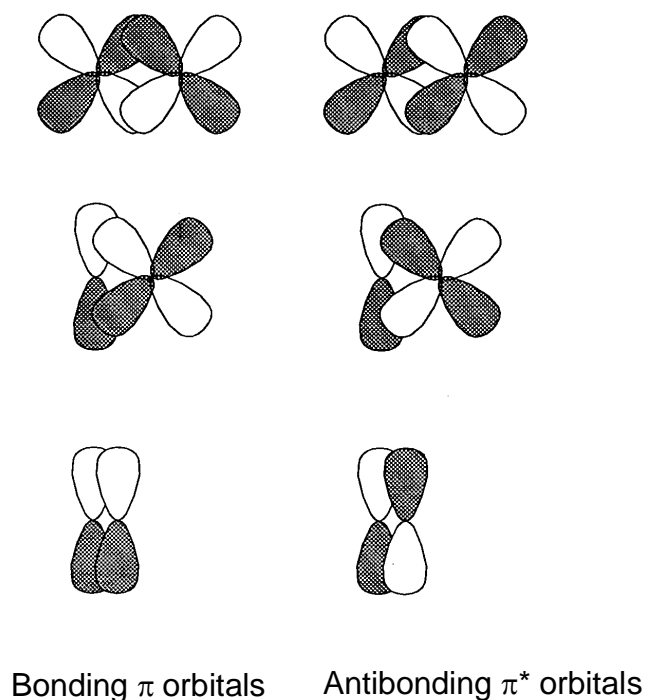

Fig. 2.17 The π molecular orbitals.

When the wave functions of two atoms are set to ϕ_A and ϕ_B , a molecular orbital is a linear combination of the atomic orbitals (LCAO) expressed as

$$\psi = C_A\phi_A + C_B\phi_B$$

Only the atomic orbitals of the valence electron shell are used in the simplest molecular orbital method. Construction of a molecular orbital is illustrated below for the simplest case of the two-atom molecules. All the levels below the HOMO are occupied by electrons and the levels above the LUMO are empty.

In a hydrogen molecule, H_2 , the overlap of the $1s$ orbital of each hydrogen atom forms a bonding orbital σ_g if the lobes have equal sign and an antibonding orbital σ_u if they have opposite signs, and two electrons occupy the bonding orbital σ_g (Fig. 2.18).

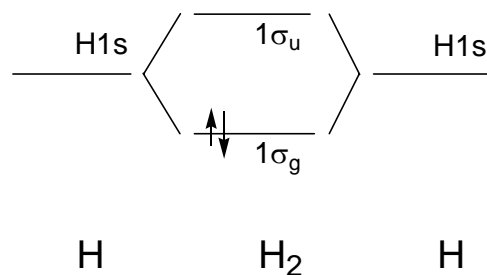

Fig. 2.18 The molecular orbitals of H_2 . The arrows indicate the electron spins.

In the two-atom molecules of the 2nd period, from lithium Li_2 to fluorine F_2 , if the z axis is set as a bond axis, $1\sigma_g$ and $1\sigma_u$ are formed by the overlap of $2s$ orbital of each atom and $2\sigma_g$ and $2\sigma_u$ from $2p_z$ orbitals and $1\pi_u$ and $1\pi_g$ from $2p_x$, and $2p_y$. The orbital energy levels for the molecules from Li_2 to N_2 are ordered as $1\sigma_g < 1\sigma_u < 1\pi_u < 2\sigma_g < 1\pi_g < 2\sigma_u$ and electrons occupy the levels sequentially from the bottom. The example of an N_2 molecule with ten valence electrons is shown in Fig. 2.19. Since the ordering of orbitals is somewhat different in O_2 and F_2 , in which the $2\sigma_g$ orbital comes under that of $1\pi_u$, the molecular orbital of the oxygen molecule, O_2 , is illustrated in Fig. 2.20. The 11th and 12th electrons among the 12 valence electrons occupy the doubly degenerate $1\pi_g$ orbital in the ground state and they have parallel spins under **Hund's rule** and hence an oxygen molecule has two unpaired electrons.

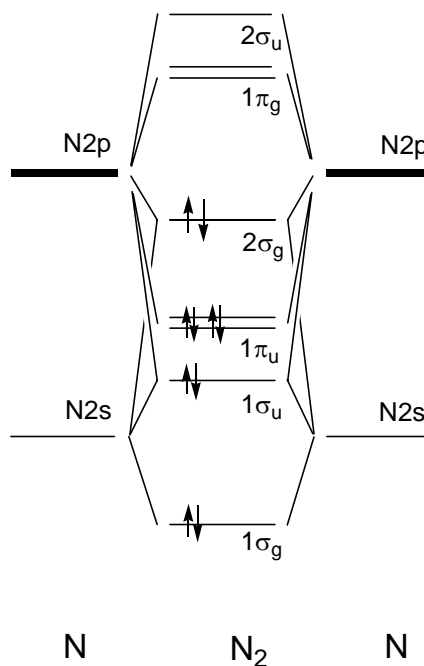

Fig. 2.19 Molecular orbitals of N_2 .

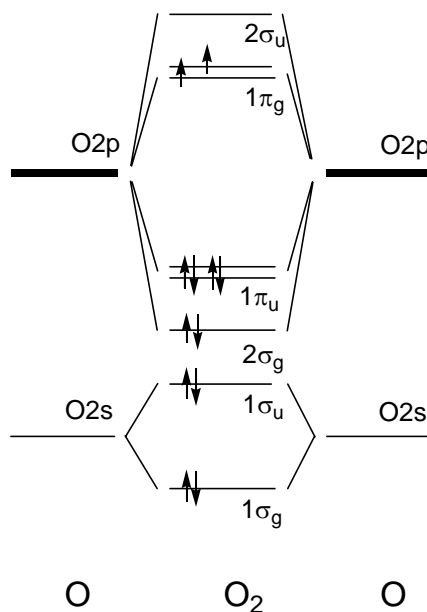

Fig. 2.20 Molecular orbitals of O₂.

The molecular orbitals of two different atoms are formed by the overlap of atomic orbitals with different energy levels. The energy level of the orbital of the atom with larger electronegativity generally is lower, and the molecular orbitals are more characteristic of the atomic orbital with the nearer energy level. Therefore, the bonding orbitals have the character of the atom with the larger electronegativity, and the antibonding orbitals that of the atom with the smaller electronegativity.

For example, five molecular orbitals in hydrogen fluoride, HF, are formed from the 1s orbital of hydrogen and the 2s and 2p orbitals of fluorine, as shown in Fig. 2.21. The bonding 1σ orbital has the 2s character of fluorine, and the antibonding 3σ orbital the 1s character of hydrogen. Since hydrogen has only one 1s orbital, the overlap with the 2p orbital of fluorine with π character is not effective, and the fluorine 2p orbital becomes a nonbonding orbital. Since HF has eight valence electrons, this nonbonding orbital is the HOMO.

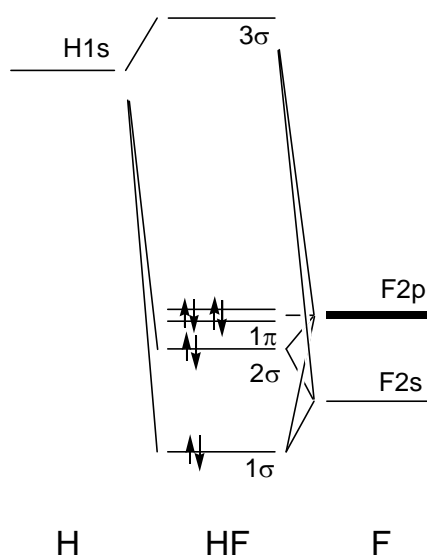

Fig. 2.21 Molecular orbitals of HF.

In carbon monoxide, CO, carbon and oxygen have $2s$ and $2p$ orbitals resulting in both sigma and pi bonds, and a triple bond is formed between the atoms. Although 8 molecular orbitals in this case are qualitatively the same as those of the isoelectronic nitrogen molecule N_2 and 10 electrons occupy the orbital up to 3σ , the energy level of each orbital differs from that of the nitrogen molecule. The bonding 1σ orbital has the $2s$ character of oxygen because of its larger electronegativity, and the bonding 1π orbital also has the $2p$ character of oxygen. The antibonding 2π and 4σ orbitals have the $2p$ character of carbon (Fig. 2.22).

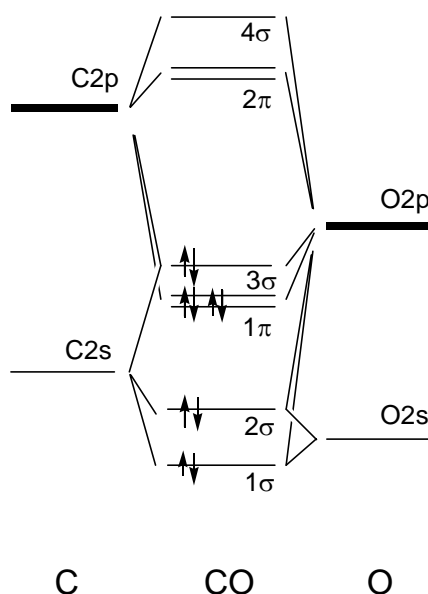

Fig. 2.22 Molecular orbitals of CO.

The bond order between atoms is a half of the number of electrons in the bonding orbitals minus those of the antibonding orbitals. For example, in N_2 or CO, it is equal to $1/2(8-2) = 3$ and is consistent with the Lewis structure.

Exercise 2.5 Why are the atomic orbitals of oxygen atom in the molecular orbital diagram of carbon monoxide, CO, lower than those of carbon?

[Answer] It is because the electronegativity of oxygen is larger than that of carbon.

Problem

2.1 Using the Pauling equation, calculate the electronegativity of chlorine from the bond energies of the hydrogen molecule H_2 (432 kJmol^{-1}), chlorine molecule Cl_2 (239 kJmol^{-1}), and hydrogen chloride HCl molecule (428 kJmol^{-1}) and electronegativity of hydrogen ($\chi = 2.1$).

2.2 Why are the energy levels $\sigma_g < \sigma_u$ in the orbitals of sigma character and $\pi_u < \pi_g$ in those of pi character in the molecular orbital diagram of N_2 or O_2 ?

Great theory and evaluation

Lewis' valence electron theory proposes that a covalent bond is formed with an electron pair and that there are eight valence electrons around each atom. This is a very important concept with which we understand the bonds between the main group elements. However, the theory was not held in high enough regard for a Nobel prize to be awarded to Lewis. One of the reasons of this disregard seems to be that chemists in the United States, Lewis' homeland, ignored his theory at first, and that a Nobel prize laureate, Langmuir, extended Lewis's theory, which was later known as the Lewis-Langmuir theory. N. Bohr, the eminent physicist who had great influence on the Nobel prize selection, evaluated Langmuir's adsorption theory more highly, which suggests that physicists considered Lewis' theory too simplistic.

There is a similar story about the transition state theory of H. Eyring. Physicists and theoretical chemists, who liked mathematical treatment of chemical phenomena, thought Eyring's theory too unsophisticated. For this reason, the most important concept in chemical kinetics was not considered for a Nobel prize. It is an episode in the history of chemistry which reminds us of the comment of R. Hoffmann, who pointed out that simple concepts are more important than deceptively complicated mathematical theories.

3 Reaction

Inorganic reactions can be described in terms of redox or acid-base concepts. Thermodynamics and electrochemistry are closely related to the analyses of redox and acid-base reactions. Although it appears that the theories of thermodynamics and electrochemistry are described by a number of complicated equations and formulae, only a few equations and parameters are required for a proper understanding. A good grasp of the sign and trend of the parameters in these key equations greatly helps this understanding. A more detailed understanding beyond this general level can be acquired by building on these basic concepts.

3.1 Thermodynamics

Thermodynamic parameters on changes of state are necessary to describe chemical bonding, structure, and reaction. This is true also in inorganic chemistry, and the most important concepts in thermodynamics are described in this section. Even simple thermodynamic knowledge is considerably useful for judging whether structures of compounds are stable and the likelihood of spontaneous reactions, and for the calculations of reaction heat, determination of reaction mechanism, and understanding of electrochemistry.

Enthalpy Since enthalpy is the heat content of a system under constant pressure, the change ΔH is negative in an exothermic reaction, and positive in an endothermic reaction. The standard reaction enthalpy, ΔH^0 , is the enthalpy change between 1 mol of products and reactants in the standard state (10^5 Pa and 298.15 K). The **standard enthalpy of formation**, ΔH_f^0 , of a compound is the standard reaction enthalpy for the formation of the compound from its constituent elements. Since enthalpy is a state function, the standard reaction enthalpy is calculated by defining the standard enthalpy of formation of simple substances to be zero.

Namely,

$$\Delta H^0 = \sum n\Delta H_f^0(\text{product}) - \sum n\Delta H_f^0(\text{reactant})$$

Entropy Entropy is a state function, and is a criterion determining whether one state can be reached spontaneously from another state. The 2nd law of thermodynamics states that the entropy, S , of an isolated system increases upon a spontaneous change. Namely,

$$\Delta S > 0$$

A thermodynamically irreversible process produces entropy. Entropy is related to the disorder of a system in statistical thermodynamics as follows:

$$S = k \ln W$$

k is the Boltzmann constant, and W is the number of the arrangements of atoms or molecules of the system with the same energy, and corresponds to the extent of disorder. As entropy becomes larger, the larger the disorder of a system.

Gibbs energy This quantity is defined as

$$\Delta G = \Delta H - T\Delta S$$

A spontaneous reaction occurs when Gibbs energy of a reaction is negative at constant temperature and pressure. The standard Gibbs free energy ΔG^0 is related to the equilibrium constant K of the reaction $A \xrightleftharpoons{K} B$.

$$\Delta G^0 = -RT \ln K$$

K is larger than 1 when ΔG^0 becomes negative, and the reaction proceeds to the right.

3.2 Electrochemistry

The **standard state** is defined as the one corresponding to 25°C (298.15 K), unit activity for all the substances in an electrochemical zero-current cell under 1 bar of pressure (10^5 Pa). For a reaction in which H^+ ions participate, the standard state is pH = 0 (approximately 1 mol acid).

In the hydrogen electrode used as the standard of electrode potential, 1 atm of hydrogen gas ($a_{H^+} = 1$) is slowly contacted with a platinum-black electrode immersed in a strong acid solution of activity $a_{H_2} = 1$. The potential is expressed as

$$E = E^0 + \frac{RT}{F} \ln \frac{a_{\text{H}^+}}{a_{\text{H}_2}}$$

and by definition $E^0 = 0$ in the standard state. The hydrogen electrode in the standard state is called the **standard hydrogen electrode**, or NHE. Although reduction potential is usually expressed with reference to the NHE standard, the hydrogen electrode is inconvenient to handle. Therefore a **saturated calomel (SCE)** or an Ag / AgCl electrode is used as a reference electrode for everyday electrochemical measurements and experimental potentials are measured against these electrodes or converted into NHE values. When the NHE value is set to 0, the SCE value is 0.242 V, and the Ag/AgCl value is 0.199 V.

A redox reaction takes place only when redox partners exist and a reactant can be either an oxidant or reductant depending on its reaction partner. The relative redox capability can be expressed numerically by introducing the reduction potentials E^0 of imaginary half-reactions (Table 3.1). The free energy change ΔG^0 of a reaction is related to E^0 ,

$$\Delta G^0 = -nFE^0$$

where n is the number of transferred electrons and F the Faraday constant 96500 Cmol^{-1} .

Table 3.1 Standard reduction potentials at 25 °C

Couple	E^0 / V
$\text{F}_2(\text{g}) + 2\text{e}^- \rightarrow 2\text{F}^-(\text{aq})$	+2.87
$\text{H}_2\text{O}_2(\text{aq}) + 2\text{H}^+(\text{aq}) + 2\text{e}^- \rightarrow 2\text{H}_2\text{O}(\text{l})$	+1.77
$\text{Ce}^{4+}(\text{aq}) + \text{e}^- \rightarrow \text{Ce}^{3+}(\text{aq})$	+1.72
$\text{MnO}_2^-(\text{aq}) + 8\text{H}^+(\text{aq}) + 5\text{e}^- \rightarrow \text{Mn}^{2+}(\text{aq}) + 4\text{H}_2\text{O}(\text{l})$	+1.51
$\text{Cl}_2(\text{g}) + 2\text{e}^- \rightarrow 2\text{Cl}^-(\text{aq})$	+1.36
$\text{O}_2(\text{g}) + 4\text{H}^+(\text{aq}) + 4\text{e}^- \rightarrow 2\text{H}_2\text{O}(\text{l})$	+1.23
$\text{Br}_2(\text{l}) + 2\text{e}^- \rightarrow 2\text{Br}^-(\text{aq})$	+1.09
$\text{Fe}^{3+}(\text{aq}) + \text{e}^- \rightarrow \text{Fe}^{2+}(\text{aq})$	+0.77
$\text{AgCl}(\text{s}) + \text{e}^- \rightarrow \text{Ag}(\text{s}) + \text{Cl}^-(\text{aq})$	+0.22
$\text{Cu}^{2+}(\text{aq}) + \text{e}^- \rightarrow \text{Cu}^+(\text{aq})$	+0.15
$2\text{H}^+(\text{aq}) + 2\text{e}^- \rightarrow \text{H}_2(\text{g})$	0
$\text{Sn}^{2+}(\text{aq}) + 2\text{e}^- \rightarrow \text{Sn}(\text{s})$	-0.14
$\text{Fe}^{2+}(\text{aq}) + 2\text{e}^- \rightarrow \text{Fe}(\text{s})$	-0.45
$\text{Zn}^{2+}(\text{aq}) + 2\text{e}^- \rightarrow \text{Zn}(\text{s})$	-0.76
$\text{Al}^{3+}(\text{aq}) + 3\text{e}^- \rightarrow \text{Al}(\text{s})$	-1.66
$\text{Mg}^{2+}(\text{aq}) + 2\text{e}^- \rightarrow \text{Mg}(\text{s})$	-2.37
$\text{Na}^+(\text{aq}) + \text{e}^- \rightarrow \text{Na}(\text{s})$	-2.71
$\text{Li}^+(\text{aq}) + \text{e}^- \rightarrow \text{Li}(\text{s})$	-3.04

For example, the two reactions

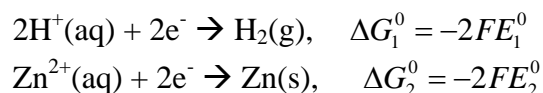

do not occur independently, but if both H^+ (aq) and Zn (s) are present, the redox reaction takes place. The equation for the actual reaction is complete when the latter equation is subtracted from the former.



The free energy change of the whole redox reaction is the difference between ΔG_1^0 , ΔG_2^0 for the respective half-reactions.

$$\begin{aligned} \Delta G^0 &= \Delta G_1^0 - \Delta G_2^0 \\ &= -2F(E_1^0 - E_2^0) \end{aligned}$$

Because half-reactions are not real and they are used in pairs, the free energy change ΔG_1^0 of H^+ is set to zero for convenience. Since the experimental value of ΔG^0 is -147 kJ, ΔG_2^0 equals 147 kJ. Potential E^0 corresponding to ΔG^0 of a half-reaction is called the **standard reduction potential**.

$$E^0 = -\frac{\Delta G^0}{nF}$$

Therefore,

$$\begin{aligned} E^0(\text{H}^+, \text{H}_2) &= 0 \quad (\text{by definition}) \\ E^0(\text{Zn}^{2+}, \text{Zn}) &= \frac{-147 \text{ kJmol}^{-1}}{2 \times 96500 \text{ Cmol}^{-1}} = -0.76 \text{ V} \end{aligned}$$

(1 J = 1 CV).

The standard potentials of various half-reactions are determined using similar procedures to that mentioned above (Table 3.1). The E^0 's of redox reactions can be calculated by combining E^0 of these half-reactions.

If E^0 of a redox reaction is positive, ΔG^0 is negative and the reaction occurs spontaneously. Consequently, instead of the free energy change the difference in reduction potentials can be used to judge the thermodynamic spontaneity of a reaction. The higher the reduction potential of a reagent the stronger its oxidation ability. The

positive or negative signs are based on the expedient of setting the reduction potential of a proton to 0, and it should be understood that a positive sign does not necessarily mean oxidizing, and a negative sign reducing. The series arranged in the order of redox power is called the **electrochemical series**.

3.3 Oxidation and reduction

(a) Oxidation number

The **oxidation number** is the formal electrical charge of a component atom in a compound or in an ion allocated in such a way that the atom with smaller electronegativity has a positive charge. Since electrical charges do not differ in the case of a molecule composed of the same atoms, the oxidation number of the atoms is the quotient of the net electrical charge divided by the number of atoms. In the case of a compound or an ion consisting of different atoms, the atoms with larger electronegativity can be considered as anions and those with smaller electronegativity as cations. For example, nitrogen is 0 valent in N_2 ; oxygen is -1 in O_2^{2-} ; nitrogen is +4 and oxygen -2 in NO_2 ; but nitrogen is -3 and hydrogen +1 in NH_3 . That is, the oxidation number can be different for the same atom combined with different partners and the atom is said to be in the formal oxidation state corresponding to that oxidation number. Although this does not express the quantitative deviation of the actual electric charge, it is convenient in counting valence electrons or in dealing with redox reactions.

Exercise 3.1 Which halogen has the largest oxidizing power?

[Answer] Since the reduction potential of fluorine is the highest, its oxidizing power is the largest.

(b) Redox reactions

Originally, oxidation meant the formation of oxides from elements or the formation of compounds by the action of oxygen, and reduction is the reverse of oxidation. The present definition of **reduction** is a reaction which gives an electron, and **oxidation** is the reaction which takes an electron. Therefore, a reagent which gives an electron is a **reductant** and one which takes an electron is an **oxidant**. As a result of a redox reaction, a reductant is oxidized and an oxidant is reduced. For example, in the reaction of molybdenum metal and chlorine gas to form molybdenum pentachloride,

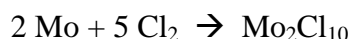

molybdenum is a reductant and changes its oxidation state from 0 to +5 and chlorine is an oxidant and changes its oxidation state from 0 to -1.

(c) Latimer diagram

A **Latimer diagram** is a diagram in which the chemical species in the highest oxidation state is placed at the left end and a series of the reduced chemical species of the same atom are arranged to the right-hand side in the order of the oxidation states, and the standard reduction potentials (V) are written above the line which connects each state. This diagram is convenient for discussing a redox reaction. Since electric potential differs between an acidic and a basic solution, different diagrams are required depending on the pH of the solution. Taking the series of the oxides and hydrides of nitrogen in acidic solution as an example, ,

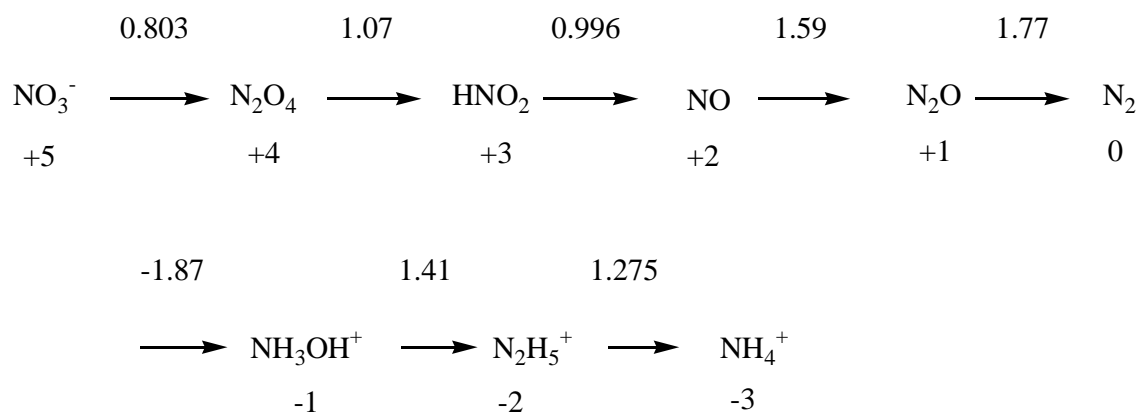

in a basic solution, the series becomes

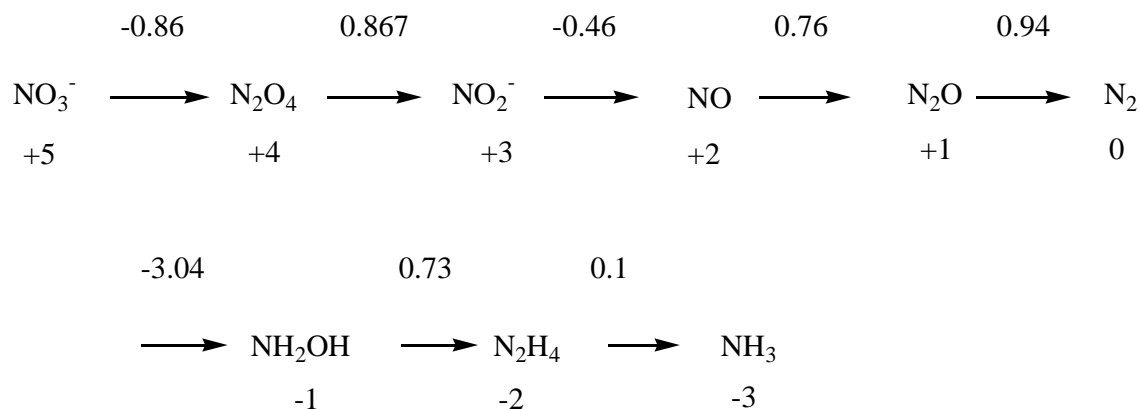

The additivity of the state function ΔG^0 is used in order to calculate the standard reduction

potential between remote oxidation states.

$$\Delta G^0 = \Delta G_1^0 + \Delta G_2^0$$

$$-(n_1 + n_2)FE^0 = -n_1FE_1^0 - n_2FE_2^0$$

Where the free energy change and electric potential between adjacent states are ΔG_1^0 , E_1^0 , ΔG_2^0 , E_2^0 , respectively, and the number of transferred electrons n_1 , n_2 .

Namely,

$$E^0 = \frac{n_1E_1^0 + n_2E_2^0}{n_1 + n_2}$$

For example, in the reduction of NO_3^- to HNO_2 , two electrons are transferred to form HNO_2 via N_2O_4 and the potential becomes

$$E^0 = \frac{0.803 \text{ V} + 1.07 \text{ V}}{2} = 0.94 \text{ V}$$

Exercise 3.2 Calculate the reduction potential of the reduction of NO_3^- to NO_2^- in a basic solution.

$$[\text{Answer}] \quad E^0 = \frac{-0.86 \text{ V} + 0.867 \text{ V}}{2} = 0.004 \text{ V}$$

In recent years, whenever a new inorganic compound is synthesized, its redox properties are investigated, usually by electrochemical measurements. **Cyclic voltammetry** is the technique of choice for the study of its redox properties, including the electric potential, the number of transferred electrons, and the reversibility of the reactions, *etc.* because of the simplicity of the measurements. It is approximately correct to consider that the oxidation potential corresponds to the energy level of the HOMO, because oxidation usually takes an electron from the HOMO and the reduction potential to the level of the LUMO since reduction adds an electron to the LUMO. However, various factors, such as solvent effects, should be taken into consideration during quantitative discussions of redox processes.

3.4 Acid and base

The definition of acid and base has changed over the course of time. This is not a problem of the orthodoxy of one definition but of the convenience of applying the concept to a particular chemical problem. Therefore, ranking the strength of acids and bases also depends on the definition of acid and base used.

(a) Arrhenius's acid and base

In 1884, Arrhenius defined that an **acid** is a substance that gives H^+ and a **base** one that gives OH^- . Namely, if an acid is HA and a base BOH , then $HA \rightarrow H^+ + A^-$ and $BOH \rightarrow B^+ + OH^-$. Therefore, when an acid and a base react, water is formed.

(b) Brønsted-Lowry's acid and base

In a new theory submitted in 1923 independently by Brønsted and Lowry, an acid is defined as a molecule or an ion which gives H^+ and a molecule or ion that receives H^+ from a partner is a base. A base is not only a molecule or an ion which gives OH^- but anything which receives H^+ . Since the acid HA gives H^+ to water in an aqueous solution and generates an **oxonium ion**, H_3O^+ , water is also a kind of base according to this definition.

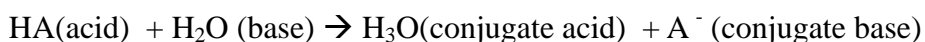

Here H_3O^+ is called a **conjugate acid** and A^- a **conjugate base**. However, since water gives H^+ to ammonia and generates NH_4^+ , it is also an acid, as is shown below.

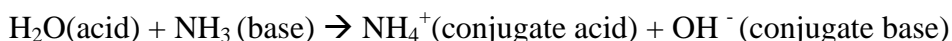

That is, water can be an acid or a base dependent on the co-reactant.

Although the definition of Brønsted-Lowry is not much different from that of Arrhenius for aqueous solutions, it is more useful because the theory was extended to non-aqueous acids and bases.

Exercise 3.3 Write the molecular formulae of nitric acid, perchloric acid, sulfuric acid, and phosphoric acid as oxo acids together with the formal oxidation number of the central atom.

[Answer] nitric acid $(HO)N^{5+}O_2$, perchloric acid $(HO)Cl^{7+}O_3$, sulfuric acid $(HO)_2S^{6+}O_2$, and phosphoric acid $(HO)_3P^{5+}O$.

Acid strength

A protonic acid gives H^+ to water and generates the oxonium ion H_3O^+ . The strength of an acid in a dilute aqueous solution is estimated from the equilibrium constant K_a

$$K_a = \frac{[H_3O^+][A^-]}{[HA]}$$

for the dissociation equilibrium,

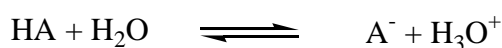

but it is more convenient to use,

$$pK_a = -\log K_a \quad \text{or} \quad pH = -\log[H_3O^+]$$

An acid with $pK_a < 0$ is classified as a strong acid and one with $pK_a > 0$ a weak acid. The conjugate base of a strong acid is a weak base. The pK_a values of typical acids at 25 °C are shown in Table 3.2.

Table 3.2 Acidity constants for aqueous solutions of acids at 25 °C.

Acid	pK_a
HF	3.17
HCl	-8*
HBr	-9*
HI	-10*
H_2CO_3	6.35
$HClO_4$	<0
HNO_3	<0
H_3PO_3	1.5
H_3PO_4	2.15
H_2SO_4	<0
CH_3COOH	4.56
C_6H_5COOH	4.00
NH_4^+	9.25
$C_5H_5NH^+$	5.25

* Estimated value

Since a solvent also works as an acid or a base, the acidity and its range depend on the solvent dissolving the acid. Full dissociation of an acid stronger than H_3O^+ gives H^+ to water, forming H_3O^+ in an aqueous solution. For example, both HBr and HI dissociate completely to become H_3O^+ , and their acidities are similar. This kind of phenomenon is called the **leveling effect**, and all acidities become equal to that of H_3O^+ . In measuring the relative acidity of strong acids, it is necessary to use a solvent whose H^+ affinity is smaller than that of water, such as acetic acid or ethanol.

Binary halo acids HX , except for HF , are very strong acids. Although the H_3O^+ concentration itself is also high in an aqueous solution of HF , the stronger hydrogen bond of F^- compared with that of other halide anions decreases the thermodynamic activity of H_3O^+ .

The acidity of oxo acids, such as phosphoric acid, sulfuric acid, nitric acid, and perchloric acid, is related to the formal oxidation number of P, S, N, and Cl. Namely, if the oxo acid H_nXO_m is denoted by $(\text{HO})_n\text{XO}_{m-n}$, the positive charge on X becomes positive $(2m-n)$, and the acidity is higher for larger value of this number. The number parallels the ease of dissociation of OH to give a proton. Acidity is higher in the following order: perchloric acid $(\text{HO})\text{ClO}_3 >$ sulfuric acid $(\text{HO})_2\text{SO}_2 >$ nitric acid $(\text{HO})\text{NO}_2 >$ phosphoric acid $(\text{HO})_3\text{PO}$. Although phosphoric acid can be written as $(\text{HO})_3\text{PO}$, phosphorous acid is not $(\text{HO})_3\text{P}$ but $(\text{HO})_2\text{HPO}$, and has an acid strength comparable to phosphoric acid.

Hammett acidity function

Hydrogen ion concentration and pH are meaningful only in dilute aqueous solutions of acids. The acidity in nonaqueous and concentrated solutions is measured using the **Hammett acidity function**. This function makes it possible to measure the acidities of various acids in a non-aqueous solvent or of an acid in various non-aqueous solvents.

The Hammett acidity function in the equilibrium,

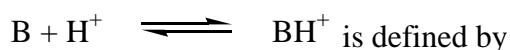

$$H_0 = \text{p}K_{\text{BH}^+} - \log \frac{[\text{BH}^+]}{[\text{B}]}$$

In a very dilute solution

$$K_{\text{BH}^+} = \frac{[\text{B}][\text{H}^+]}{[\text{BH}^+]} \text{ and}$$

$$H_0 = -\log \frac{[B][H^+]}{[BH^+]} - \log \frac{[BH^+]}{[B]} = -\log[H^+] = \text{pH}$$

An acid with $-H_0$ over 6 is called a **superacid**. This is an acid that is 10^6 times stronger than a 1 molar solution of a strong acid. $-H_0$ for pure sulfuric acid is 12.1, 21.1 for a solution of HF in SbF_5 , and 26.5 for the combination of HSO_3F and SbF_5 .

Superacids have the ability to remove H^- from a hydrocarbon and perform H-D exchange and C-C bond scission, *etc.*

(c) Lewis acid and base

Whereas the concept of Brønsted acid and base is limited to the transfer of protons, a Lewis acid A is generally defined as an acceptor, and a Lewis base B a donor, of an electron pair. An acid A and a base $:\text{B}$ bind together to form an adduct $\text{A}:\text{B}$. For example, a Lewis acid BF_3 and a Lewis base OEt_2 (diethylether) form an adduct $\text{F}_3\text{B}:\text{OEt}_2$. The stability increases by the completion of an octet around boron when such an adduct forms. The stability of an adduct is expressed by the equilibrium constant of the reaction

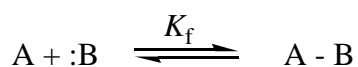

$$K_f = \frac{[\text{A}:\text{B}]}{[\text{A}][:\text{B}]}$$

Therefore, the Lewis acidities of a series of acids are measured by comparing K_f against a common base $:\text{B}$. Since a proton is also an electron acceptor, Brønsted acids are the special case of the more general Lewis definition of acids. According to this definition, a co-ordinate bond in a transition metal complex is also an acid-base reaction of a ligand (Lewis base) with a metal center (Lewis acid).

V. Gutmann proposed the negative enthalpy of formation (kcal mol^{-1} unit) of the adduct ($\text{Cl}_5\text{Sb}-\text{Sol}$) of Sol (solvent) with a standard acid (SbCl_5) in dichloroethane as a measure of the Lewis basicity of a solvent. This is called the **donor number** (D.N.) of a solvent. On the other hand, the ^{31}P NMR chemical shift of Et_3P in a solvent is defined as the measure of the Lewis acidity of the solvent and is called the **acceptor number** (A.N.).

Hard and soft acids and bases

R. G. Pearson classified Lewis acids and bases according to their **hardness and**

softness. This classification is an extension of the original theory of S. Ahrland, J. Chatt, and N. R. Davies, who proposed that metal cations were classified in the order of the stability constants K_f of the formation of the complexes of the metal cations with halide anions. Namely, the order of K_f is $I < Br < Cl < F$ toward metal ions belonging to class *a*, and $F < Cl < Br < I$ toward those of class *b*. The class *a* type metal cations are hard acids, and class *b* type ones are soft acids. The metal cations which are not much dependent on the kind of halogens have **borderline** character.

What should be noticed here is that K_f tends to become large for the combination of a hard acid and a hard base, or a soft acid and a soft base. If the concept is extended from simple metal cations and halide anions to general Lewis acids and bases, they can similarly be classified in terms of the hard and soft acid-base affinity. Typical hard acids and bases, and soft acids and bases are shown in Table 3.3.

Table 3.3 The classification of Lewis acids and bases

	Hard	Borderline	Soft
Acids	H^+, Li^+, Na^+, K^+ $Be^{2+}, Mg^{2+}, Ca^{2+}$ $Al^{3+}, Ti^{4+}, Cr^{3+}$ Fe^{3+}, BF_3, Cl^{7+}	$Fe^{2+}, Co^{2+}, Ni^{2+}, Cu^{2+}$ $Zn^{2+}, Sn^{2+}, Pb^{2+}$ Sb^{3+}, Bi^{3+}	Cu^+, Ag^+, Au^+ $Tl^+, Cd^{2+}, Hg^+, Hg^{2+}$ $Pd^{2+}, Pt^{2+}, Pt^{4+}$
Bases	NH_3, H_2O, R_2O F^-, OH^-, O^{2-} $NO_3^-, SO_4^{2-}, PO_4^{3-}$	N_3^-, N_2, NO_2^- Br^- SO_3^{2-}	H^-, CN^-, R^- I^- PR_3, SR_2, CO

The qualitative expression “softness” is a chemical paraphrasing of the ease of polarization and the larger contribution of covalency than ionicity in bonding. The cations of alkali and alkaline earth metals as well as aluminum are hard and the cations of mercury, copper, silver, and gold, *etc.* are soft. Whereas oxides are hard, sulfides and phosphorus compounds are soft. In the minerals of the Earth’s crust, aluminum, which is hard and oxophilic is found as an oxide, and cadmium, which is soft and chalcophilic is found as a sulfide.

Exercise 3.4 Applying the concept of hard and soft acids for ferric and ferrous ions, what kind of minerals are expected in iron ores?

[Answer] Fe^{3+} is a hard acid and Fe^{2+} is a borderline acid. Therefore, it is likely that the main iron ores are oxide minerals. Although the main ores are actually the oxides hematite Fe_2O_3 or magnetite Fe_3O_4 , a Fe^{2+} sulfide pyrite FeS_2 is also widely distributed.

Acid-base and oxidation-reduction

Some people confuse acid-base and redox reactions. This confusion may be caused firstly by the similar terms originating from oxygen and secondly by misunderstanding about electron transfer. Historically, A. L. Lavoisier, who was one of the great founders of modern chemistry in the 18th century, considered that oxygen was the basis of all acids. He also defined oxidation as the formation of oxides from an element and oxygen. It then took a long time before the present definitions of acid-base and redox reactions were proposed and the old definitions were no longer satisfactory. Furthermore, the Lewis acid accepts an electron pair from a base forming a Lewis acid-base complex, and the oxidizing agent accepts electrons from a reducing agent and is reduced. The fact that acids and oxidizing agents are electron acceptors, and that bases and reducing agents are electron donors, is one of the causes of this confusion.

Problem

3.1 The Latimer diagram of oxygen is shown below. Write the oxidation number of oxygen in each compound.

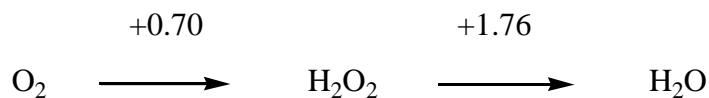

Calculate the reduction potential of the reaction which converts an oxygen molecule to water, and judge whether this reaction is a spontaneous reaction.

3.2 Which is the stronger base, ammonia or pyridine?

3.3 The order of the Lewis acidity of boron halides is $\text{BF}_3 < \text{BCl}_3 < \text{BBr}_3$. Is this order reasonable from the standpoint of the electronegativities of halogens?

4 Chemistry of Nonmetallic Elements

There are about 20 nonmetallic elements which are generally found as either anions in ionic compounds or else as elementary substances. It is possible to learn the names, structures, and main properties of these various compounds following a relatively simple classification. Hydrides, oxides, sulfides, and halides are important, and essential for the study of pure and applied inorganic chemistry of the solid state compounds.

4.1 Hydrogen and hydrides

(a) Hydrogen

Hydrogen is the simplest element consisting of a proton and an electron, and the most abundant element in the universe. It is next to oxygen and silicon, and about 1 wt% of all the elements on the Earth. Needless to say, most hydrogen exists as water on the Earth. Since its polarity may change freely between hydride (H^-), atom (H), and proton (H^+), hydrogen also forms various compounds with many elements including oxygen and carbon. Therefore, hydrogen is highly important in chemistry.

Of the three kinds of isotopes of hydrogen, deuterium, D, was discovered by H. C. Urey and others in 1932, and subsequently tritium, T, was prepared from deuterium in 1934. About 0.015% of hydrogen is present as deuterium, and this can be enriched by electrolysis of water. Tritium is a radioactive isotope emitting β -particles with a half-life of 12.33 years. Since the mass of deuterium and tritium is about twice and three times that of hydrogen, respectively, the physical properties of the isotopes, and compounds containing them, differ considerably. Some properties of the isotopes and water are listed in Table 4.1. When the E-H bond in a hydrogen compound is converted into the E-D by deuterium substitution, the E-H stretching frequency in an infrared spectrum is reduced to about $1/\sqrt{2}$, which is useful for determining the position of the hydrogen atom. It is sometimes possible to conclude that scission of the bond with a hydrogen is the rate-determining step when the deuterium substitution shows a marked effect on the rate of reaction of a hydrogen-containing compound.

Since the nuclear spin of hydrogen is $1/2$ and given its abundance, it is the most important nuclide for NMR spectroscopy. NMR is widely used not only for identification of organic compounds, but also for medical diagnostic purposes using MRI (magnetic

resonance imaging) of water in living bodies. Human organs can now be observed with this non-invasive method.

Table 4.1 Properties of isotopic hydrogen and water

Properties	H ₂	D ₂	T ₂	H ₂ O	D ₂ O	T ₂ O
Melting point*	13.957	18.73	20.62	0.00	3.81	4.48
Boiling point	20.39	23.67	25.04	100.00	101.42	101.51
Density (g cm ⁻³ , 25°C)				0.9970	1.1044	1.2138
Temp. of maximum density (°C)				3.98	11.23	13.4

* hydrogen (K), water (°C)

There are nuclear-spin isomers in diatomic molecules of the nuclides whose spin is not zero. Especially in the case of a hydrogen molecule, the difference of properties is significant. Spins of **para-hydrogen** are anti-parallel and the sum is 0 leading to a **singlet state**. Spins of **ortho-hydrogen** are parallel and the sum is 1 resulting in a **triplet state**. Since *para*-hydrogen is in a lower energy state, it is the stabler form at low temperatures. The theoretical ratio of *para*-hydrogen is 100% at 0 K, but it decreases to about 25% at room temperature, since the ratio of *ortho*-hydrogen increases at higher temperatures. Gas chromatography and rotational lines in the electronic band spectrum of H₂ can distinguish two hydrogen isomers.

(b) Hydride

Binary hydrides can be classified according to the position of the element in the periodic table, and by the bond characters. The hydrides of alkali and alkaline earth metals among *s*-block elements are ionic compounds structurally analogous to halides and are called **saline hydrides**. The Group 13-17 *p*-block elements form covalent molecular hydrides. No hydride of rare gas elements has been reported.

Some of the *d*-block and *f*-block transition metals form metal hydrides exhibiting metallic properties. Transition metals which do not give binary hydrides form many **molecular hydride complexes** coordinated by stabilization ligands, such as carbonyl (CO), tertiaryphosphines (PR₃), or cyclopentadienyl (C₅H₅) (refer to Section 6.1). Typical hydrides of each class are given below.

Saline hydrides

Lithium hydride, LiH, is a colorless crystalline compound (mp (melting point) 680 °C). Li⁺ and H⁻ form a lattice with a rock salt type structure. Quantitative evolution of

hydrogen gas at the anode during the electrolysis of the fused salt suggests the existence of H⁻. Water reacts vigorously with lithium hydride evolving hydrogen gas. Since it dissolves in ethers slightly, the hydride is used as a reducing agent in organic chemistry.

Calcium hydride, CaH₂, is a colorless crystalline compound (mp 816 °C), and reacts mildly with water evolving hydrogen gas. This hydride is used as a hydrogen gas generator, or a dehydrating agent for organic solvents. It is used also as a reducing agent.

Lithium tetrahydridoaluminate, LiAlH₄, is a colorless crystalline compound (decomposes above 125°C) usually called lithium aluminum hydride. The hydride dissolves in ethers, and reacts violently with water. It is used as a reducing and hydrogenating agent and for dehydrating organic solvents.

Sodium tetrahydroborate, NaBH₄, is a white crystalline compound (decomposes at 400 °C) usually called sodium borohydride. It is soluble in water and decomposes at high temperatures evolving hydrogen gas. It is used as a reducing agent for inorganic and organic compounds, for preparation of hydride complexes, *etc.*

Molecular hydrides

All hydrides other than those of carbon (methane) and oxygen (water) are poisonous gases with very high reactivity and should be handled very carefully. Although there are methods of generating the gases in laboratories, recently many are also available in cylinders.

Diborane, B₂H₆, is a colorless and poisonous gas (mp -164.9 °C and bp -92.6 °C) with a characteristic irritating odor. This hydride is a powerful reducing agent of inorganic and organic compounds. It is also useful in organic synthesis as a hydroboration agent that introduces functional groups to olefins, after addition of an olefin followed by reactions with suitable reagents.

Silane, SiH₄, is a colorless and deadly poisonous gas (mp -185 °C and bp -111.9 °C) with a pungent smell, and is called also monosilane.

Ammonia, NH₃, is a colorless and poisonous gas (mp -77.7 °C and bp -33.4 °C) with a characteristic irritating odor. Although it is used in many cases as aqueous ammonia since it dissolves well in water, liquid ammonia is also used as a nonaqueous solvent for special reactions. Since the Harber-Bosch process of ammonia synthesis was developed in 1913, it has been one of the most important compounds in chemical industries and is used as a starting chemical for many nitrogenous compounds. It is used also as a refrigerant.

Phosphine, PH₃, is a colorless and deadly poisonous gas (mp -133 °C and bp -87.7 °C) with a bad smell, and is called also phosphorus hydride. It burns spontaneously in air. It is used in vapor phase epitaxial growth, in transition metal coordination chemistry, *etc.*

Hydrogen sulfide, H_2S , is a colorless and deadly poisonous gas (mp $-85.5\text{ }^\circ\text{C}$ and bp $-60.7\text{ }^\circ\text{C}$) with a rotten egg odor. Although often used with insufficient care, it is very dangerous and should be handled only in an environment with good ventilation. It is used in chemical analysis for the precipitation of metal ions, preparation of sulfur compounds, *etc.*

Hydrogen fluoride, HF , is a colorless, fuming, and low boiling point liquid (mp $-83\text{ }^\circ\text{C}$ and bp $19.5\text{ }^\circ\text{C}$), with an irritating odor. It is used for preparing inorganic and organic fluorine compounds. Because of its high permittivity, it can be used as a special nonaqueous solvent. The aqueous solution is called fluoric acid and is stored in polyethylene containers since the acid corrodes glass.

Metallic hydrides

The hydrides MH_x which show metallic properties are nonstoichiometric interstitial-type solids in which hydrogen occupies a part of the cavities of the metal lattice. Usually x is not an integer in these compounds. There are Group 3 (Sc, Y), Group 4 (Ti, Zr, Hf), Group 5 (V, Nb, Ta), Cr, Ni, Pd, and Cu metallic hydrides among the d block elements, but the hydrides of other metals in Group 6 to 11 are not known. Palladium Pd reacts with hydrogen gas at ambient temperatures, and forms hydrides that have the composition PdH_x ($x < 1$). Many metallic hydrides show metallic conductivity. LaNi_5 is an intermetallic compound of lanthanum and nickel. It occludes nearly 6 hydrogen atoms per unit lattice and is converted to LaNi_5H_6 . It is one of the candidates for use as a hydrogen storage material with the development of hydrogen-fueled cars.

Exercise 4.1 Write the oxidation number of the hydrogen atom in H_2 , NaH , NH_3 , and HCl .

[Answer] H_2 (0), NaH (-1), NH_3 (+1), and HCl (+1).

Hydride complexes

Complexes coordinated by hydride ligands are called **hydride complexes**. The Group 6 to 10 transition metals that do not form binary hydrides give many hydride complexes with auxiliary ligands such as carbonyl and tertiaryphosphines. Although it was only at the end of the 1950s that hydride was accepted as a ligand, thousands of hydride complexes are known at present. Furthermore, with the synthesis in the 1980's of molecular hydrogen complexes, the chemistry of transition metal hydrogen compounds took a new turn. Research on the homogeneous catalysis of hydrocarbons in which hydride or dihydrogen complexes participate is also progressing.

4.2 Main group elements of 2nd and 3rd periods and their compounds

(a) Boron

Refined elemental boron is a black solid with a metallic luster. The unit cell of crystalline boron contains 12, 50, or 105 boron atoms, and the B_{12} icosahedral structural units join together by 2 center 2 electron (2c-2e) bonds and 3 center 2 electron (3c-2e) bonds (electron deficient bonds) between boron atoms (Fig. 4.1). Boron is very hard and shows semiconductivity.

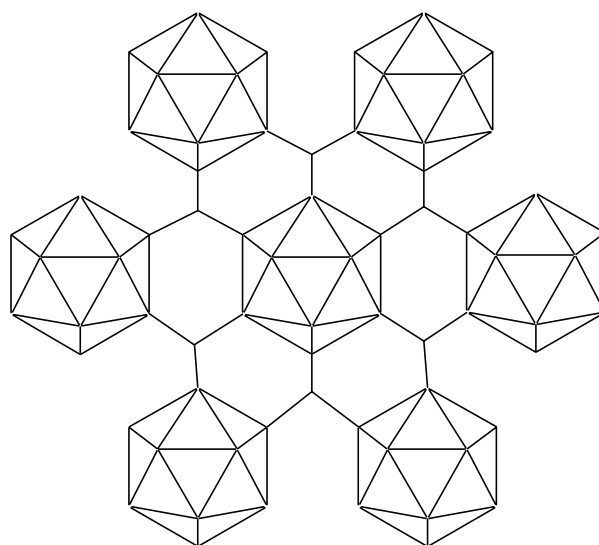
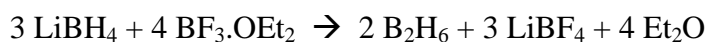

Fig. 4.1 The structure of the elemental boron with B_{12} icosahedra.

The chemistry of **boranes** (boron hydrides) started from the research of A. Stock reported during the period 1912-1936. Although boron is adjacent to carbon in the periodic table, its hydrides have completely different properties from those of hydrocarbons. The structures of boron hydrides in particular were unexpected and could be explained only by a new concept in chemical bonding. For his contribution to the very extensive new inorganic chemistry of boron hydrides, W. N. Lipscomb won the Nobel prize in 1976. Another Nobel prize (1979) was awarded to H. C. Brown for the discovery and development of a very useful reaction in organic synthesis called hydroboration.

Because of the many difficulties associated with the low boiling points of boranes, as well as their activity, toxicity, and air-sensitivity, Stock had to develop new experimental methods for handling the compounds *in vacuo*. Using these techniques, he prepared six boranes B_2H_6 , B_4H_{10} , B_5H_9 , B_5H_{11} , B_6H_{10} , and $B_{10}H_{14}$ by the reactions of magnesium boride, MgB_2 , with inorganic acids, and determined their compositions. However, additional research was necessary to determine their structures. At present, the

original synthetic method of Stock using MgB_2 as a starting compound is used only for the preparation of B_6H_{10} . Since reagents such as lithium tetrahydroborate, LiBH_4 , and sodium tetrahydroborate, NaBH_4 , are now readily available, and **diborane**, B_2H_6 , is prepared according to the following equation, higher boranes are synthesized by the pyrolysis of diborane.



A new theory of chemical bonding was introduced to account for the bonding structure of diborane, B_2H_6 . Although an almost correct hydrogen-bridged structure for diborane was proposed in 1912, many chemists preferred an ethane-like structure, $\text{H}_3\text{B}-\text{BH}_3$, by analogy with hydrocarbons. However, H. C. Longuet-Higgins proposed the concept of the electron-deficient **3-center 2-electron bond** (3c-2e bond) and it was proven by electron diffraction in 1951 that the structure was correct (Fig. 4.2).

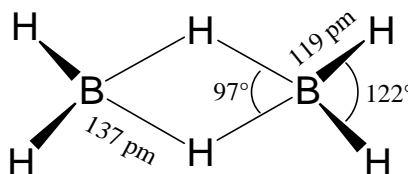
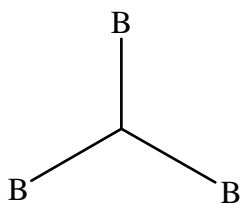

Fig. 4.2 Structure of diborane.

It has been elucidated by electron diffraction, single crystal X-ray structure analysis, infrared spectroscopy, *etc.* that boranes contain 3-center 2-electron bonds (3c-2e bond) B-H-B and



besides the usual 2 center 2 electron covalent bonds (2c-2e bond) B-H and B-B. Such structures can be treated satisfactorily by molecular orbital theory. Boranes are classified into *closo*, *nido*, *arachno*, *etc.* according to the skeletal structures of boron atoms.

Closo-borane $[\text{B}_n\text{H}_n]^{2-}$ has the structure of a closed polyhedron of n boron atoms bonded to n hydrogen atoms, as seen in the examples of a regular octahedron $[\text{B}_6\text{H}_6]^{2-}$ and

an icosahedron $[\text{B}_{12}\text{H}_{12}]^{2-}$. The boranes of this series do not contain B-H-B bonds. Boranes B_nH_{n+4} , such as B_5H_9 , form structures with B-B, B-B-B, and B-H-B bonds and lack the apex of the polyhedron of *closo* boranes, and are referred to as *nido* type boranes. Borane B_nH_{n+6} , such as B_4H_{10} , have a structures that lacks two apexes from the *closo* type and are more open. Skeletons are also built by B-B, B-B-B, and B-H-B bonds, and these are called *arachno* type boranes. The structures of typical boranes are shown in Fig. 4.3.

(a) *closo*- $[\text{B}_6\text{H}_6]^{2-}$ (b) *nido*- $[\text{B}_5\text{H}_9]$ (c) *arachno*- $[\text{B}_4\text{H}_{10}]$ (d) *closo*- $[\text{B}_{12}\text{H}_{12}]^{2-}$

Fig. 4.3 Structures of boranes.

Not only diborane but also higher boranes are **electron-deficient compounds** that are difficult to explain using Lewis' electronic structure based on simple 2-center 2-electron covalent bonds.

Exercise 4.2 Why is diborane called an electron deficient compound?

[Answer] It is because there are only 12 valence electrons of boron and hydrogen atoms, although 16 electrons are necessary to assign two electrons each to eight B-H bonds.

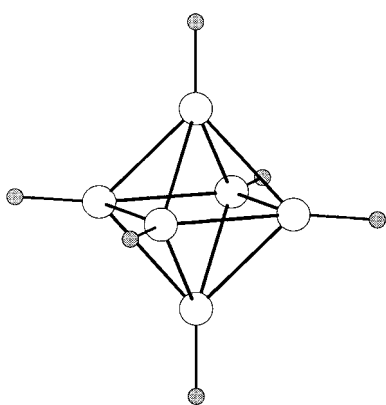
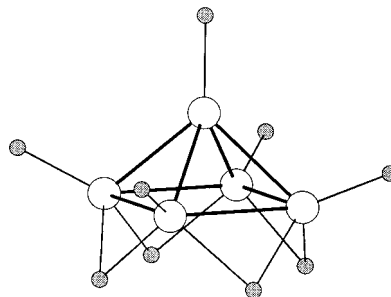
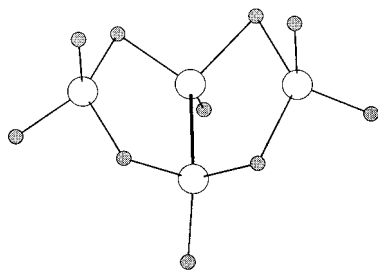
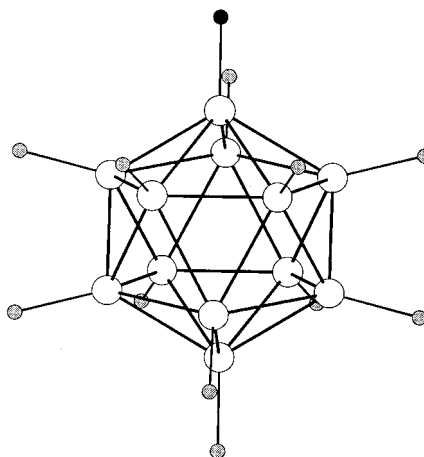
K. Wade summarized the relation of the number of valence electrons used for skeletal bonds and the structures of boranes and proposed an empirical rule called the **Wade rule**. According to this rule, when the number of boron atoms is n , the skeletal valence electrons are $2(n+1)$ for a *closo* type, $2(n+2)$ for a *nido* type, and $2(n+3)$ for an *arachno* type borane. The relationship between the skeletal structure of a cluster compound and the number of valence electrons is also an important problem in the cluster compounds of transition metals, and the Wade rule has played a significant role in furthering our understanding of the structures of these compounds.

(b) Carbon

Graphite, diamond, fullerene, and amorphous carbon are carbon allotropes. Usually a carbon atom forms four bonds using four valence electrons.

Graphite Graphite is structured as layers of honeycomb-shaped 6 membered rings of carbon atoms that look like condensed benzene rings without any hydrogen atoms (Fig. 4.4). The carbon-carbon distance between in-layer carbon atoms is 142 pm and the bonds have double bond character analogous to aromatic compounds. Since the distance between layers is 335 pm and the layers are held together by comparatively weak van der Waals forces, they slide when subjected to an applied force. This is the origin of the lubricating properties of graphite. Various molecules, such as alkali metals, halogens, metal halides, and organic compounds intercalate between the layers and form intercalation compounds. Graphite has semi-metallic electrical conductivity (about 10^{-3} Ωcm parallel to layers and about 100 times more resistant in the perpendicular direction).

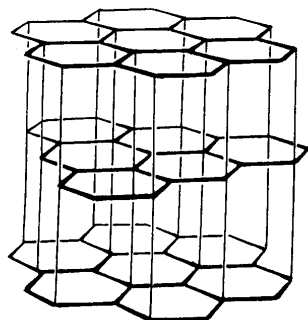

Fig. 4.4 Structure of graphite.

Diamond Its structure is called the diamond-type structure (Fig. 4.5). A unit cell of diamond contains eight carbon atoms and each carbon atom is 4-coordinate in a regular tetrahedron. Diamond is the hardest substance known, with a Mohs hardness 10. Diamond has very high heat conductivity although it is an electrical insulator. Although previously a precious mineral only formed naturally, industrial diamonds are now commercially prepared in large quantities at high temperatures (1200 °C or higher) and under high pressures (5 GPa or more) from graphite using metal catalysts. In recent years, diamond thin films have been made at low temperatures (about 900 °C) and under low pressures (about 102 Pa) by the pyrolysis of hydrocarbons, and are used for coating purposes, *etc.*

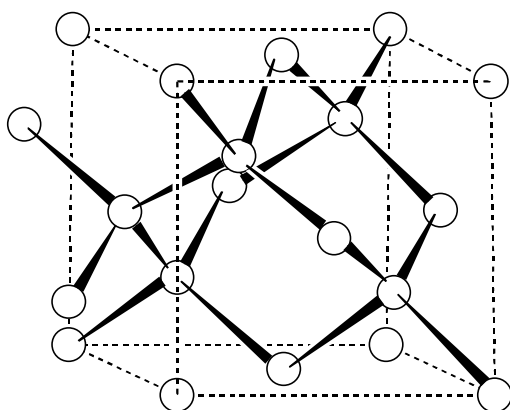

Fig. 4.5 Structure of diamond.

Fullerene Fullerene is the general name of the 3rd carbon allotrope, of which the soccer ball-shaped molecule C_{60} is a typical example (Fig.4.6). R. E. Smalley, H. W. Kroto and others detected C_{60} in the mass spectra of the laser heating product of graphite

in 1985, and fullerene's isolation from this so-called "soot" was reported in 1991. It has the structure of a truncated (corner-cut)-icosahedron and there is double bond character between carbon atoms. It is soluble in organic solvents, with benzene solutions being purple. Usually, it is isolated and purified by chromatography of fullerene mixtures. Wide-ranging research on chemical reactivities and physical properties such as superconductivity, is progressing rapidly. Besides C_{60} , C_{70} and carbon nanotubes are attracting interest.

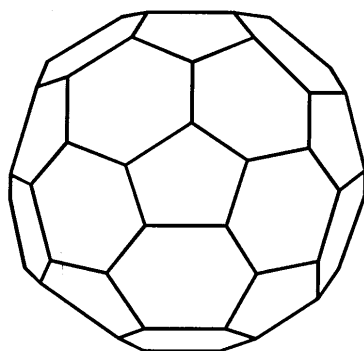

Fig. 4.6 Structure of C_{60} .

(c) Silicon

Silicon is the most abundant element in the earth's crust after oxygen. Most of this silicon exists as a component of silicate rocks and the element is not found as a simple substance. Therefore, silicon is produced by the reduction of quartz and sand with high-grade carbon using electric arc furnaces. Higher-grade silicon is obtained by hydrogen reduction of $SiHCl_3$, which is produced by the hydrochlorination of low purity silicon followed by rectification. The silicon used for semiconductor devices is further refined by the crystal Czochralski or zone melting methods. The crystal (mp 1410 °C) has a metallic luster and the diamond type structure.

There are three isotopes of silicon, ^{28}Si (92.23%), ^{29}Si (4.67%), and ^{30}Si (3.10%). Because of its nuclear spin of $I = 1/2$, ^{29}Si is used for NMR studies of organic silicon compounds or silicates (solid-state NMR).

Silicates and organosilicon compounds show a wide range of structures in silicon chemistry. Section 4.3 (c) describes the properties of silicates. Organosilicon chemistry is the most active research area in the inorganic chemistry of main group elements other than carbon. Silicon chemistry has progressed remarkably since the development of an industrial process to produce organosilicon compounds by the direct reaction of silicon with methyl chloride CH_3Cl in the presence of a copper catalyst. This historical process

was discovered by E. G. Rochow in 1945. Silicone resin, silicone rubber, and silicone oil find wide application. In recent years, silicon compounds have also been widely used in selective organic syntheses.

Although silicon is a congener of carbon, their chemical properties differ considerably. A well-known example is the contrast of silicon dioxide SiO_2 with its 3-dimensional structure, and gaseous carbon dioxide, CO_2 . The first compound $(\text{Mes})_2\text{Si}=\text{Si}(\text{Mes})_2$ (Mes is mesityl $\text{C}_6\text{H}_2(\text{CH}_3)_3$) with a silicon-silicon double bond was reported in 1981, in contrast with the ubiquitous carbon-carbon multiple bonds. Such compounds are used to stabilize unstable bonds with bulky substituents (kinetic stabilization).

Exercise 4.3 Why are the properties of CO_2 and SiO_2 different?

[Answer] Their properties are very different because CO_2 is a chain-like three-atom molecule and SiO_2 is a solid compound with the three dimensional bridges between silicon and oxygen atoms.

(d) Nitrogen

Nitrogen is a colorless and odorless gas that occupies 78.1% of the atmosphere (volume ratio). It is produced in large quantities together with oxygen (bp -183.0°C) by liquefying air (bp -194.1°C) and fractionating nitrogen (bp -195.8°C). Nitrogen is an inert gas at room temperatures but converted into nitrogen compounds by biological nitrogen fixation and industrial ammonia synthesis. The cause of its inertness is the large bond energy of the $\text{N}\equiv\text{N}$ triple bond.

The two isotopes of nitrogen are ^{14}N (99.634%) and ^{15}N (0.366%). Both isotopes are NMR-active nuclides.

(e) Phosphorus

Simple phosphorus is manufactured by the reduction of calcium phosphate, $\text{Ca}_3(\text{PO}_4)_2$, with quartz rock and coke. Allotropes include white phosphorus, red phosphorus, and black phosphorus.

White phosphorus is a molecule of composition of P_4 (Fig. 4.7). It has a low melting-point (mp 44.1°C) and is soluble in benzene or carbon disulfide. Because it is pyrophoric and deadly poisonous, it must be handling carefully.

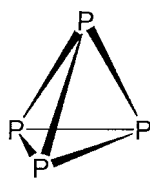

Fig. 4.7 Structure of white phosphorus.

Red phosphorus is amorphous, and its structure is unclear. The principal component is assumed to be a chain formed by the polymerization of P_4 molecules as the result of the opening of one of the P-P bonds. It is neither pyrophoric nor poisonous, and used in large quantities for the manufacturing of matches, *etc.*

Black phosphorus is the most stable allotrope and is obtained from white phosphorus under high pressure (about 8 GPa). It is a solid with a metallic luster and a lamellar structure. Although it is a semiconductor under normal pressures, it shows metallic conductivity under high pressures (10 GPa).

Phosphorus compounds as ligands

Tertiary phosphines, PR_3 , and phosphites, $P(OR)_3$, are very important ligands in transition metal complex chemistry. Especially triphenylphosphine, $P(C_6H_5)_3$, triethyl phosphine, $P(C_2H_5)_3$, and their derivatives are useful ligands in many complexes, because it is possible to control precisely their electronic and steric properties by modifying substituents (refer to Section 6.3 (c)). Although they are basically sigma donors, they can exhibit some pi accepting character by changing the substituents into electron accepting Ph (phenyl), OR, Cl, F, *etc.* The order of the electron-accepting character estimated from the C-O stretching vibrations and ^{13}C NMR chemical shifts of the phosphine- or phosphite-substituted metal carbonyl compounds is as follows (Ar is an aryl and R is an alkyl).

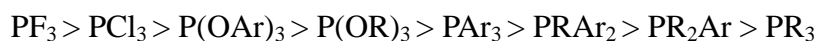

On the other hand, C. A. Tolman has proposed that the angle at the vertex of a cone that surrounds the substituents of a phosphorus ligand at the van der Waals contact distance can be a useful parameter to assess the steric bulkiness of phosphines and phosphites. This parameter, called the **cone angle**, is widely used (Fig. 4.8). When the cone angle is large, the coordination number decreases by steric hindrance, and the dissociation equilibrium constant and dissociation rate of a phosphorus ligand become large (Table 4.2). The numerical expression of the steric effect is very useful, and many

studies have been conducted into this effect.

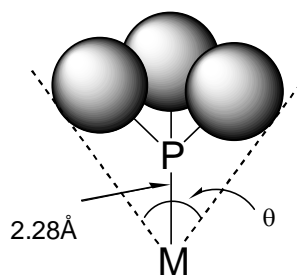

Fig. 4.8 Cone angle.

Table 4.2 Cone angles (θ°) of tertiary phosphines and phosphites

Ligands	Cone angles
P(OEt) ₃	109
PMe ₃	118
P(OPh) ₃	121
PEt ₃	132
PMe ₂ Ph	136
PPh ₃	145
P ^t Pr ₃	160
P ^t Bu ₃	182

4.3 Oxygen and oxides

(a) Oxygen

Dioxygen, O₂, is a colorless and odorless gas (bp -183.0 °C) that occupies 21% of air (volume ratio). Since oxygen atoms are also the major components of water and rocks, oxygen is the most abundant element on the Earth's surface. Despite its abundance, it was established as an element as late as the 18th century. Since an immense quantity of oxygen gas is consumed for steel production now, it is separated in large quantities from liquified air.

The isotopes of oxygen are ¹⁶O (99.762% abundance), ¹⁷O (0.038%), and ¹⁸O (0.200%). ¹⁷O has nuclear spin $I = 5/2$ and is an important nuclide for NMR measurements. ¹⁸O is used as a tracer for tracking reagents or for the study of reaction mechanisms. It is also useful for the assignment of absorption lines in infrared or Raman spectra by means of isotope effects.

As already described in section 2.3 (e), dioxygen, O_2 , in the ground state has two unpaired spins in its molecular orbitals, shows paramagnetism and is called **triplet dioxygen**. In the excited state, the spins are paired and dioxygen becomes diamagnetic, which is called singlet dioxygen. Singlet dioxygen is important in synthetic chemistry, because it has characteristic oxidation reactivity. **Singlet dioxygen** is generated in a solution by an energy transfer reaction from a photo-activated complex or by the pyrolysis of ozonides (O_3 compounds).

Superoxide ion, O_2^- , and **peroxide ion**, O_2^{2-} , are the anions of dioxygen (Table 4.3). They can be isolated as alkali metal salts. There is another state, O_2^+ , called the **dioxygen (1+) cation**, and it can be isolated as a salt with suitable anions.

Table 4.3 Oxidation states of dioxygen

	Bond order	Compound	O-O distance (Å)	$\nu(O-O)$ (cm^{-1})
O_2^+	2.5	$O_2[AsF_6]$	1.123	1858
O_2	2.0		1.207	1554
O_2^-	1.5	$K[O_2]$	1.28	1145
O_2^{2-}	1.0	$Na_2[O_2]$	1.49	842

Ozone, O_3 , is an allotrope of oxygen that is an unstable gas with an irritating odor. Ozone is a bent three-atom molecule (117°) and has unique reactivities. In recent years it has been discovered that ozone plays an important role in intercepting the detrimental ultraviolet radiation from the sun in the upper atmospheric zone, and in protecting life on the Earth from photochemical damage. It is now clear that chlorofluorocarbons, frequently used as refrigerants or as cleaners of electronic components, destroy the ozone layer, and measures are being taken on a global scale to cope with this serious environmental problem.

(b) Oxides of hydrogen

Oxygen is highly reactive, and direct reactions with many elements form oxides. Water is an oxide of hydrogen and is crucially important for the global environment and life in general.

Water H_2O

Ninety-seven percent of water on the Earth is present as sea water, 2% as ice of the polar zone, and fresh water represents only the small remaining fraction. Fundamental chemical and physical properties of water are very significant to chemistry. The main physical properties are shown in Table 4.1. Most of the unusual properties of water are caused by its strong hydrogen bonds. Physical properties of water differ considerably

with the presence of isotopes of hydrogen. At least nine polymorphs of ice are known and their crystal structures depend on the freezing conditions of the ice.

Water has a bond angle of 104.5° and a bond distance of 95.7 pm as a free molecule. It is described in Section 3.4 (b) that self-dissociation of water generates oxonium ion, H_3O^+ . Further water molecules add to H_3O^+ to form $[\text{H}(\text{OH}_2)_n]^+$ (H_5O_2^+ , H_7O_3^+ , H_9O_4^+ , and $\text{H}_{13}\text{O}_6^+$), and the structures of the various species have been determined.

Hydrogen peroxide H_2O_2

Hydrogen peroxide is an almost colorless liquid (mp -0.89°C and bp (extrapolated) 151.4°C) that is highly explosive and dangerous in high concentrations. Usually it is used as a dilute solution but occasionally 90% aqueous solutions are used. Since it is consumed in large quantities as a bleaching agent for fiber and paper, large-scale industrial synthetic process has been established. This process applies very subtle catalytic reactions to produce a dilute solution of hydrogen peroxide from air and hydrogen using a substituted anthraquinone. This dilute solution is then concentrated.

When deuterium peroxide is prepared in a laboratory, the following reaction is applied.

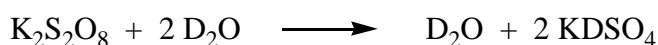

Hydrogen peroxide is decomposed into oxygen and water in the presence of catalysts such as manganese dioxide, MnO_2 . Hydrogen peroxide may be either an oxidant or a reductant depending on its co-reactants. Its reduction potential in an acidic solution expressed in a Latimer diagram (refer to Section 3.3 (c)) is

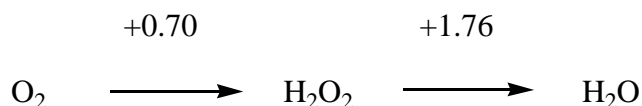

(c) Silicon oxides

Silicon oxides are formed by taking SiO_4 tetrahedra as structural units and sharing the corner oxygen atoms. They are classified by the number of corner-sharing oxygen atoms in the SiO_4 tetrahedra, as this determines their composition and structure. When the SiO_4 tetrahedra connect by corner sharing, the structures of the polymeric compounds become a chain, a ring, a layer, or 3-dimensional depending on the connection modes of adjacent units. Fractional expression is adopted in order to show the bridging modes. Namely, the numerator in the fraction is the number of bridging oxygens and the denominator is 2, meaning that one oxygen atom is shared by two tetrahedra. The empirical formulae are as follows and each structure is illustrated in Fig. 4.9 in

coordination-polyhedron form.

A bridge is constructed with one oxygen atom. $(\text{SiO}_3\text{O}_{1/2})^{3-} = \text{Si}_2\text{O}_7^{6-}$

Bridges are constructed with two oxygen atoms. $(\text{SiO}_2\text{O}_{2/2})_n^{2n-} = (\text{SiO}_3)_n^{2n-}$

Bridges are constructed with three oxygen atoms. $(\text{SiOO}_{3/2})_n^{n-} = (\text{Si}_2\text{O}_5)_n^{2n-}$

Amalgamation of bridging modes with three oxygen and two oxygen atoms.

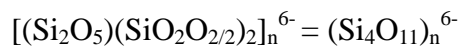

Bridges are constructed with four oxygen atoms. $(\text{SiO}_{4/2})_n = (\text{SiO}_2)_n$

Silicates with various cross linkage structures are contained in natural rocks, sand, clay, soil, *etc.*

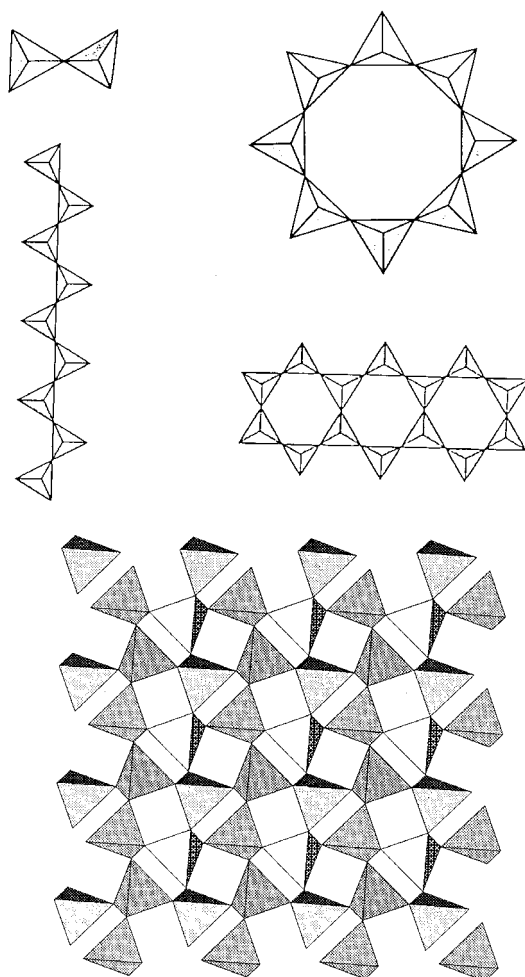

Fig. 4.9 Bridging modes of the SiO_4 tetrahedra.

Aluminosilicates

There are many minerals in which some silicon atoms of silicate minerals are replaced by aluminum atoms. They are called **aluminosilicates**. Aluminum atoms replace the silicon atoms in the tetrahedral sites or occupy the octahedral cavities of oxygen atoms, making the structures more complicated. The substitution of a tetravalent silicon by a trivalent aluminum causes a shortage of charge which is compensated by occlusion of extra cations such as H^+ , Na^+ , Ca^{2+} , *etc.* Feldspars are a typical aluminosilicate mineral, and $KAlSi_3O_8$ (orthoclase) and $NaAlSi_3O_8$ (albite) are also known well. Feldspars take 3-dimensional structures in which all the corners of the SiO_4 and AlO_4 tetrahedra are shared.

On the other hand, 2-dimensional layers are formed if $[AlSiO_5]^{3-}$ units are lined, and stratified minerals like mica are constructed if 6-coordinate ions are inserted between layers. If the number of oxygen atoms in the layers is not enough to form regular octahedra between layers, hydroxide groups bond to the interstitial Al^{3+} ions. Muscovite, $KAl_2(OH)_2Si_3AlO_{10}$, is a type of mica with such a structure and can be easily peeled into layers.

Zeolite

One of the important aluminosilicates is zeolite. Zeolites are present as natural minerals and also many kinds of zeolites are prepared synthetically in large quantities. The SiO_4 and AlO_4 tetrahedra are bonded by oxygen bridges, and form holes and tunnels of various sizes. The structures are composites of the basic structural units of tetrahedral MO_4 . As shown in Fig. 4.10, the basic units are cubes with 8 condensed MO_4 , hexagonal prisms with 12 condensed MO_4 , and truncated octahedra with 24 condensed MO_4 .

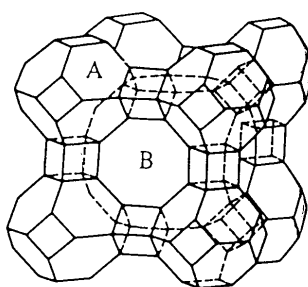

Fig. 4.10 Structure of zeolite A.

Silicon or aluminum atoms are located on the corners of the polyhedra and the bridging oxygen atoms on the middle of each edge (it should be noted that this expression is different from the polyhedron model of oxides).

When these polyhedra are bonded, various kinds of zeolite structures are formed. For example, the truncated octahedra called β cages are the basic frames of **synthetic zeolite A**, $\text{Na}_{12}(\text{Al}_{12}\text{Si}_{12}\text{O}_{48}) \cdot 27\text{H}_2\text{O}$, and the quadrangle portions are connected through cubes. It can be seen that an octagonal tunnel B forms when eight truncated octahedra bind in this way. The structure in which the hexagon portions connect through hexagonal prisms is faujasite, $\text{NaCa}_{0.5}(\text{Al}_2\text{Si}_5\text{O}_{14}) \cdot 10\text{H}_2\text{O}$.

Alkali metal or alkaline earth metal cations exist in the holes, and the number of these cations increases with the content of aluminum to compensate for the charge deficiency. The structures of zeolites have many crevices in which cations and water are contained. Utilizing this cation-exchange property, zeolites are used in large quantities as softeners of hard water. As zeolites dehydrated by heating absorb water efficiently, they are also used as desiccants of solvents or gases. Zeolites are sometimes called **molecular sieves**, since the sizes of holes and tunnels change with the kinds of zeolites and it is possible to segregate organic molecules according to their sizes. Zeolites can fix the directions of more than two molecules in their cavities and can be used as catalysts for selective reactions.

For example, synthetic zeolite ZSM-5 is useful as a catalyst to convert methanol to gasoline. This zeolite is prepared hydrothermally in an autoclave (high-pressure reaction vessel) at *ca.* 100 °C using meta-sodium aluminate, NaAlO_2 , as the source of aluminum oxide and silica sol as the source of silicon oxide and with tetrapropylammonium bromide, Pr_4NBr , present in the reaction. The role of this ammonium salt is a kind of mold to form zeolite holes of a fixed size. When the ammonium salt is removed by calcination at 500 °C, the zeolite structure remains.

(d) Nitrogen oxides

A variety of nitrogen oxides will be described sequentially from lower to higher oxidation numbers (Table 4.4).

Table 4.4 Typical oxides of main group elements

	1	2	12	13	14	15	16	17	18
2	Li ₂ O	BeO		B ₂ O ₃	CO CO ₂	N ₂ O NO NO ₂			
3	Na ₂ O Na ₂ O ₂ NaO ₂	MgO		Al ₂ O ₃	SiO ₂	P ₄ O ₆ P ₄ O ₁₀	SO ₂ SO ₃	Cl ₂ O ClO ₂	
4	K ₂ O K ₂ O ₂ KO ₂	CaO	ZnO	Ga ₂ O ₃	GeO ₂	As ₄ O ₆ As ₄ O ₁₀	SeO ₂ SeO ₃		
5	Rb ₂ O Rb ₂ O ₂ Rb ₉ O ₂	SrO	CdO	In ₂ O ₃	SnO ₂	Sb ₄ O ₆ Sb ₄ O ₁₀	TeO ₂ TeO ₃	I ₂ O ₅	XeO ₃ XeO ₄
6	Cs ₂ O Cs ₁₁ O ₃	BaO	HgO	Tl ₂ O Tl ₂ O ₃	PbO PbO ₂	Bi ₂ O ₃			

Dinitrogen monoxide, N₂O. Oxide of monovalent nitrogen. Pyrolysis of ammonium nitrate generates this oxide as follows.

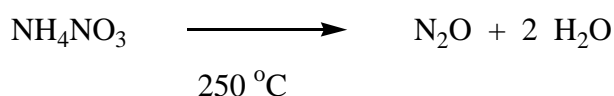

Although the oxidation number is a formality, it is an interesting and symbolic aspect of the versatility of the oxidation number of nitrogen that NH₄NO₃ forms a monovalent nitrogen oxide (+1 is a half of the average of -3 and +5 for NH₄ and NO₃, respectively). The N-N-O bond distances of the straight N₂O are 112 pm (N-N) and 118 pm (N-O), corresponding to 2.5th and 1.5th bond order, respectively. N₂O (16e) is isoelectronic with carbon dioxide CO₂ (16e). This compound is also called laughing gas and is widely used for analgesia.

Nitric oxide, NO. An oxide of divalent nitrogen. This is obtained by reduction of nitrite as follows.

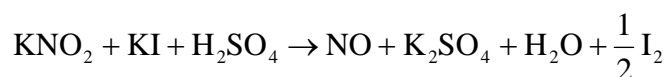

Having an odd number of valence electrons (11 electrons), it is paramagnetic. The N-O distance is 115 pm and the bond has double bond character. The unpaired electron in the highest antibonding π^* orbital is easily removed, and NO becomes NO⁺ (nitrosonium),

which is isoelectronic with CO. Since an electron is lost from the antibonding orbital, the N-O bond becomes stronger. The compounds NOBF_4 and NOHSO_4 containing this cation are used as 1 electron oxidants.

Although NO is paramagnetic as a monomer in the gas phase, dimerization in the condensed phase leads to diamagnetism. It is unique as a ligand of transition metal complexes and forms complexes like $[\text{Fe}(\text{CO})_2(\text{NO})_2]$, in which NO is a neutral 3-electron ligand. Although M-N-O is straight in these kind of complexes, the M-N-O angle bends to $120^\circ \sim 140^\circ$ in $[\text{Co}(\text{NH}_3)_5\text{NO}] \text{Br}_2$, in which NO^+ coordinates as a 4-electron ligand. It has become clear recently that nitric oxide has various biological control functions, such as blood-pressure depressing action, and it attracts attention as the second inorganic material after Ca^{2+} to play a role in signal transduction.

Dinitrogen trioxide, N_2O_3 . The oxidation number of nitrogen is +3, and this is an unstable compound decomposing into NO and NO_2 at room temperature. It is generated when equivalent quantities of NO and NO_2 are condensed at low temperatures. It is light blue in the solid state and dark blue in the liquid state but the color fades at higher temperatures.

Nitrogen dioxide, NO_2 . A nitrogen compound with oxidation number +4. It is an odd electron compound with an unpaired electron, and is dark reddish brown in color. It is in equilibrium with the colorless dimer dinitrogen tetroxide, N_2O_4 . The proportion of NO_2 is 0.01% at -11°C , and it increases gradually to 15.9% at its boiling point (21.2°C), and becomes 100% at 140°C .

N_2O_4 can be generated by the pyrolysis of lead nitrate as follows.

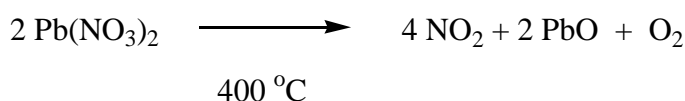

When NO_2 is dissolved in water, nitric acid and nitrous acid are formed.

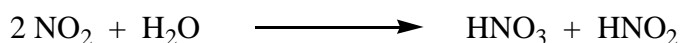

By one electron oxidation, NO^{2+} (nitroyl) forms and the O-N-O angle changes from 134° to 180° in the neutral NO_2 . On the other hand, by one electron reduction, NO^{2-} (nitrito) forms and the angle bends to 115° .

Dinitrogen pentoxide, N_2O_5 , is obtained when concentrated nitric acid is carefully dehydrated with phosphorus pentoxide at low temperatures. It sublimes at 32.4°C . As it forms nitric acid by dissolving in water, it may also be called a nitric anhydride.

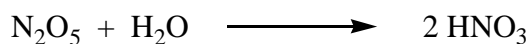

Although it assumes an ion-pair structure NO_2NO_3 and straight NO_2^+ and planar NO_3^- ions are located alternately in the solid phase, it is molecular in the gas phase.

Oxoacids

Oxyacids of nitrogen include nitric acid, HNO_3 , nitrous acid, HNO_2 , and hyponitrous acid, $\text{H}_2\text{N}_2\text{O}_2$. Nitric acid, HNO_3 , is one of the most important acids in the chemical industry, along with sulfuric acid and hydrochloric acid. Nitric acid is produced industrially by the **Ostwald process**, which is the oxidation reaction of ammonia in which the oxidation number of nitrogen increases from -3 to +5. Because the Gibbs energy of the direct conversion of dinitrogen to the intermediate NO_2 is positive, and therefore the reaction is unfavorable thermodynamically, dinitrogen is firstly reduced to ammonia, and this is then oxidized to NO_2 .

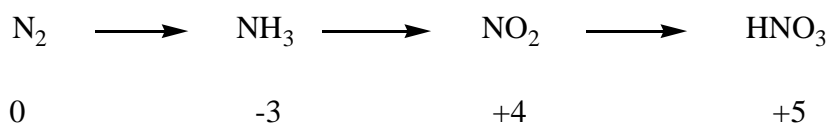

Nitric acid, HNO_3 . Commercial nitric acid is a *ca.*70% aqueous solution and vacuum distillation of it in the presence of phosphorus pentoxide gives pure nitric acid. As it is a strong oxidizing agent while also being a strong acid, it can dissolve metals (copper, silver, lead, *etc.*) which do not dissolve in other acids. Gold and platinum can even be dissolved in a mixture of nitric acid and hydrochloric acid (*aqua regia*). The nitrate ion, NO_3^- , and nitrite ion, NO_2^- , take various coordination forms when they coordinate as ligands in transition metal complexes.

Nitrous acid, HNO_2 . Although not isolated as a pure compound, aqueous solutions are weak acids ($\text{p}K_a = 3.15$ at 25 °C) and important reagents. Since NaNO_2 is used industrially for hydroxylamine (NH_2OH) production and also used for diazotidation of aromatic amines, it is important for the manufacture of azo dyes and drugs. Among the various coordination forms of NO_2^- isomers now known, monodentate nitro (N-coordination) and nitrito (O-coordination) ligands had already been discovered in the 19th century.

(e) Phosphorus oxides.

The structures of the phosphorus oxides P_4O_{10} , P_4O_9 , P_4O_7 , and P_4O_6 have been

determined.

Phosphorus pentoxide, P_4O_{10} , is a white crystalline and sublimable solid that is formed when phosphorus is oxidized completely. Four phosphorus atoms form a tetrahedron and they are bridged by oxygen atoms (refer to Fig. 2.12). Since a terminal oxygen atom is bonded to each phosphorus atom, the coordination polyhedron of oxygen is also a tetrahedron. When the molecular P_4O_{10} is heated, a vitrified isomer is formed. This is a polymer composed of similar tetrahedra of phosphorus oxide with the same composition that are connected to one another in sheets. Since it is very reactive with water, phosphorus pentoxide is a powerful dehydrating agent. It is used not only as a desiccant, but also it has remarkable dehydration properties, and N_2O_5 or SO_3 can be formed by dehydration of HNO_3 or H_2SO_4 , respectively. Phosphorus pentoxide forms orthophosphoric acid, H_3PO_4 , when reacted with sufficient water, but if insufficient water is used, various kinds of condensed phosphoric acids are produced depending on the quantity of reacting water.

Phosphorus trioxide, P_4O_6 , is a molecular oxide, and its tetrahedral structure results from the removal of only the terminal oxygen atoms from phosphorus pentoxide. Each phosphorus is tri-coordinate. This compound is formed when white phosphorus is oxidized at low temperatures in insufficient oxygen. The oxides with compositions intermediate between phosphorus pentoxide and trioxide have 3 to 1 terminal oxygen atoms and their structures have been analyzed.

Although arsenic and antimony give molecular oxides As_4O_6 and Sb_4O_6 that have similar structures to P_4O_6 , bismuth forms a polymeric oxide of composition Bi_2O_3 .

Phosphoric acid

Orthophosphoric acid, H_3PO_4 . It is one of the major acids used in chemical industry, and is produced by the hydration reaction of phosphorus pentoxide, P_4O_{10} . Commercial phosphoric acid is usually of 75-85% purity. The pure acid is a crystalline compound (mp $42.35\text{ }^\circ\text{C}$). One terminal oxygen atom and three OH groups are bonded to the phosphorus atom in the center of a tetrahedron. The three OH groups release protons making the acid tribasic ($pK_1 = 2.15$). When two orthophosphoric acid molecules condense by the removal of an H_2O molecule, pyrophosphoric acid, $H_4P_2O_7$, is formed.

Phosphonic acid, H_3PO_3 . This acid is also called phosphorous acid and has H in place of one of the OH groups of orthophosphoric acid. Since there are only two OH groups, it is a dibasic acid.

Phosphinic acid, H_3PO_2 . It is also called hypophosphorous acid, and two of the OH groups in orthophosphoric acid are replaced by H atoms. The remaining one OH group shows monobasic acidity. If the PO_4 tetrahedra in the above phosphorus acids bind by O

bridges, many **condensed phosphoric acids** form. **Adenosine triphosphate** (ATP), **deoxyribonucleic acid** (DNA), *etc.*, in which the triphosphorus acid moieties are combined with adenosine are phosphorus compounds that are fundamentally important for living organisms.

(f) Sulfur oxides

Sulfur dioxide, SO_2 . This is formed by the combustion of sulfur or sulfur compounds. This is a colorless and poisonous gas (bp $-10.0\text{ }^\circ\text{C}$) and as an industrial emission is one of the greatest causes of environmental problems. However, it is very important industrially as a source material of sulfur. Sulfur dioxide is an angular molecule, and recently it has been demonstrated that it takes various coordination modes as a ligand to transition metals. It is a nonaqueous solvent similar to liquid ammonia, and is used for special reactions or as a solvent for special NMR measurements.

Sulfur trioxide, SO_3 . It is produced by catalytic oxidation of sulfur dioxide and used for manufacturing sulfuric acid. The usual commercial reagent is a liquid (bp $44.6\text{ }^\circ\text{C}$). The gaseous phase monomer is a planar molecule. It is in equilibrium with a ring trimer ($\gamma\text{-SO}_3 = \text{S}_3\text{O}_9$) in the gaseous or liquid phase. In the presence of a minute amount of water SO_3 changes to $\beta\text{-SO}_3$, which is a crystalline high polymer with a helical structure. $\alpha\text{-SO}_3$ is also known as a solid of still more complicated lamellar structure. All react violently with water to form sulfuric acid.

Sulfur acids.

Although there are many oxy acids of sulfur, most of them are unstable and cannot be isolated. They are composed of a combination of $\text{S}=\text{O}$, S-OH , S-O-S , and S-S bonds with a central sulfur atom. As the oxidation number of sulfur atoms varies widely, various redox equilibria are involved.

Sulfuric acid, H_2SO_4 . It is an important basic compound produced in the largest quantity of all inorganic compounds. Pure sulfuric acid is a viscous liquid (mp $10.37\text{ }^\circ\text{C}$), and dissolves in water with the generation of a large amount of heat to give strongly acidic solutions.

Thiosulfuric acid, $\text{H}_2\text{S}_2\text{O}_3$. Although it is generated if thiosulfate is acidified, the free acid is unstable. The $\text{S}_2\text{O}_3^{2-}$ ion is derived from the replacement of one of the oxygen atoms of SO_4^{2-} by sulfur, and is mildly reducing.

Sulfurous acid, H_2SO_3 . The salt is very stable although the free acid has not been isolated. The SO_3^{2-} ion that has pyramidal C_{3v} symmetry is a reducing agent. In dithionic acid, $\text{H}_2\text{S}_2\text{O}_6$, and the dithionite ion, $\text{S}_2\text{O}_6^{2-}$, the oxidation number of sulfur is +5, and one S-S bond is formed. This is a very strong reducing agent.

(g) Metal oxides

Oxides of all the metallic elements are known and they show a wide range of properties in terms of structures, acidity and basicity, and conductivity. Namely, an oxide can exhibit molecular, 1-dimensional chain, 2-dimensional layer, or 3-dimensional structures. There are basic, amphoteric, and acidic oxides depending on the identity of the metallic element. Moreover, the range of physical properties displayed is also broad, from insulators, to semiconductors, metallic conductors, and superconductors. The compositions of metallic oxide can be simply stoichiometric, stoichiometric but not simple, or sometimes non-stoichiometric. Therefore, it is better to classify oxides according to each property. However, since structures give the most useful information to understand physical and chemical properties, typical oxides are classified first according to the dimensionality of their structures (Table 4.4, Table 4.5).

Table 4.5 Typical binary oxides of transition metals

Oxidation number	3	4	5	6	7	8	9	10	11
+1		Ti ₂ O ^l							Cu ₂ O Ag ₂ O
+2		TiO	VO NbO		MnO	FeO	CoO	NiO	CuO Ag ₂ O ₂
+3	Sc ₂ O ₃ Y ₂ O ₃	Ti ₂ O ₃	V ₂ O ₃	Cr ₂ O ₃		Fe ₂ O ₃		Rh ₂ O ₃	
+4		TiO ₂ ZrO ₂ HfO ₂	VO ₂ NbO ₂ TaO ₂	CrO ₂ MoO ₂ WO ₂	MnO ₂ TcO ₂ ReO ₂	RuO ₂ OsO ₂	RhO ₂ IrO ₂	PtO ₂	
+5			V ₂ O ₅ ^l Nb ₂ O ₅ Ta ₂ O ₅						
+6				CrO ₃ ^c MoO ₃ ^l WO ₃	ReO ₃				
+7					Re ₂ O ₇ ^l				
+8						RuO ₄ ^m OsO ₄ ^m			

^m molecular, ^c chain, ^l layer, others 3-dimensional.

Molecular oxides.

Ruthenium tetroxide, RuO₄, (mp 25 °C and bp 40 °C) and osmium tetroxide, OsO₄, (mp 40 °C and bp 130 °C) have low melting and boiling points and their structures are molecular. They are prepared by heating the metal powder in an oxygen atmosphere at

about 800 °C. The structures are tetrahedral and they are soluble in organic solvents and also slightly soluble in water. OsO₄ is used in organic chemistry especially in the preparation of *cis*-diols by oxidation of C=C double bonds. For example, cyclohexane diol is prepared from cyclohexene. Since these oxides are very volatile and poisonous, they should be handled very carefully.

1-dimensional chain-like oxide

Mercury oxide, HgO, is a red crystalline compound that is formed when mercury nitrate is heated in air. HgO has an infinite zigzag structure. Chromium trioxide, CrO₃, is a red crystalline compound with a low melting point (197 °C) and its structure is composed of CrO₄ tetrahedra connected in one dimension. The acidity and oxidizing power of chromium trioxide are very high. It is used as an oxidation reagent in organic chemistry.

Two dimensional stratified oxides

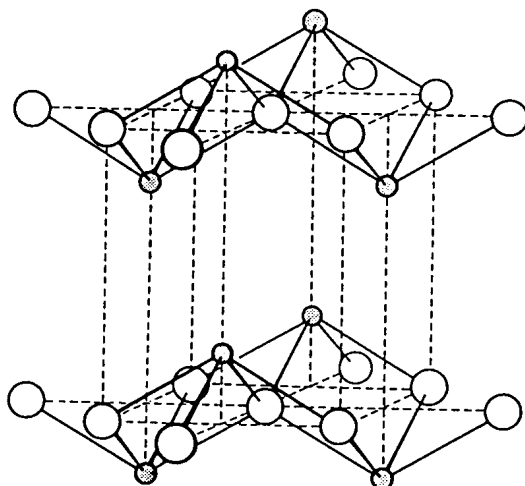

Fig. 4.11 Structure of PbO.

Tetragonal and blue black tin oxide, SnO, and red lead oxide, PbO, are layer compounds composed of square pyramids with the metal atom at the peak and four oxygen atoms at the bottom vertices. The structure contains metal atoms above and below the layer of oxygen atoms alternately and in parallel with the oxygen layers (Fig. 4.11). Molybdenum trioxide, MoO₃, is formed by burning the metal in oxygen and shows weak oxidizing power in aqueous alkaline solutions. It has a 2-dimensional lamellar structure in which the chains of edge-sharing octahedra MoO₆ are corner-linked.

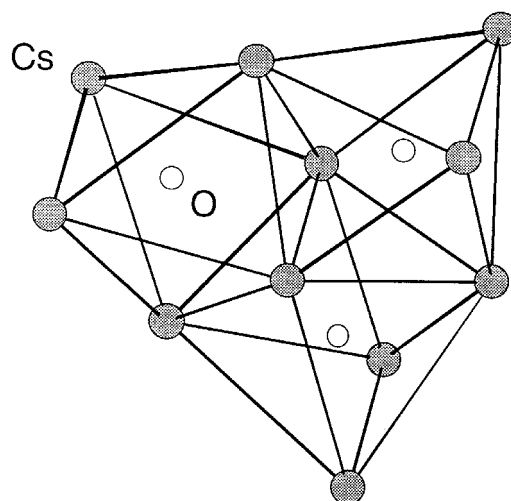

Fig. 4.12 Structure of Cs_{11}O_3 .

3-dimensional oxides

Alkali metal oxides, M_2O (M is Li, Na, K, and Rb), have the antifluorite structure (refer to Section 2.2 (e)), and Cs_2O is the anti- CdCl_2 lamellar structure (refer to Section 4.5 (d)). M_2O forms together with peroxide M_2O_2 when an alkali metal burns in air, but M_2O becomes the main product if the amount of oxygen is less than stoichiometric. Alternatively, M_2O is obtained by the pyrolysis of M_2O_2 after complete oxidation of the metal. Peroxide M_2O_2 (M is Li, Na, K, Rb, and Cs) can be regarded also as the salts of dibasic acid H_2O_2 . Na_2O_2 is used industrially as a bleaching agent. Superoxide MO_2 (M is K, Rb, and Cs) contains paramagnetic ion O_2^- , and is stabilized by the large alkali metal cation. If there is a deficit of oxygen during the oxidation reactions of alkali metals, suboxides like Rb_9O_2 or Cs_{11}O_3 form. These suboxides exhibit metallic properties and have interesting cluster structures (Fig. 4.12). Many other oxides in which the ratio of an alkali metal and oxygen varies, such as M_2O_3 , have also been synthesized.

MO type metal oxides

Except for BeO (Wurtz type), the basic structure of Group 2 metal oxides MO is the rock salt structure. They are obtained by calcination of the metal carbonates. Their melting points are very high and all are refractory. Especially quicklime, CaO , is produced and used in large quantities. The basic structure of transition metal oxides MO (M is Ti, Zr, V, Mn, Fe, Co, Ni, Eu, Th, and U) is also the rock salt structure, but they have defect structures and the ratios of a metal and oxygen are non-stoichiometric. For example, FeO has the composition Fe_xO ($x = 0.89\text{-}0.96$) at 1000°C . The charge

imbalance of the charge is compensated by the partial oxidation of Fe^{2+} into Fe^{3+} . NbO has a defective rock salt-type structure where only three NbO units are contained in a unit cell.

MO_2 type metal oxides

The dioxides of Sn, Pb, and other transition metals with small ionic radii take rutile-type structures (Fig. 4.13), and the dioxides of lanthanide and actinide metals with large ionic radii take fluorite-type structures.

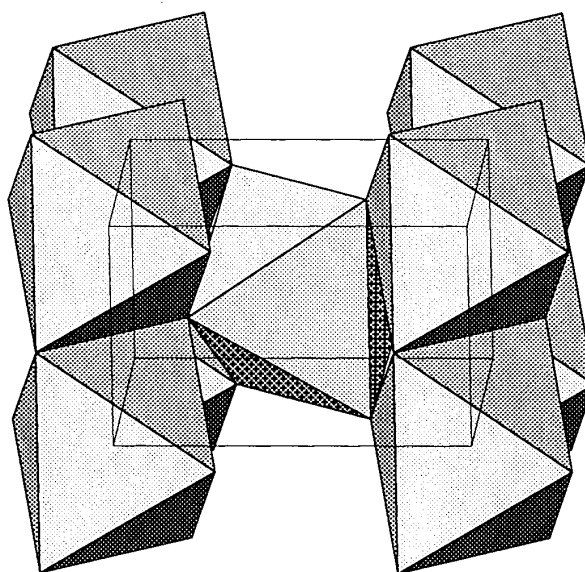

Fig. 4.13 Structure of rutile.

Rutile is one of the three structure types of TiO_2 , and is the most important compound used in the manufacture of the white pigments. Rutile has also been extensively studied as a water photolysis catalyst. As shown in Fig. 4.13, the rutile-type structure has TiO_6 octahedra connected by the edges and sharing corners. It can be regarded as a deformed hcp array of oxygen atoms in which one half of the octahedral cavities are occupied by titanium atoms. In the normal rutile-type structure, the distance between adjacent M atoms in the edge-sharing octahedra is equal, but some rutile-type metal oxides that exhibit semiconductivity have unequal M-M-M distances. CrO_2 , RuO_2 , OsO_2 , and IrO_2 show equal M-M distances and exhibit metallic conductivity.

Manganese dioxide, MnO_2 , tends to have a non-stoichiometric metal-oxygen ratio when prepared by the reaction of manganese nitrate and air, although the reaction of manganese with oxygen gives almost stoichiometric MnO_2 with a rutile structure. The

following reaction of manganese dioxide with hydrochloric acid is useful for generating chlorine in a laboratory.



Zirconium dioxide, ZrO_2 , has a very high melting-point (2700°C), and is resistant to acids and bases. It is also a hard material and used for crucibles or firebricks. However, since pure zirconium dioxide undergoes phase transitions at 1100°C and 2300°C that result in it breaking up, solid solutions with CaO or MgO are used as fireproof materials. This is called **stabilized zirconia**.

M_2O_3 -type oxides

The most important structure of the oxides of this composition is the **corundum structure** (Al, Ga, Ti, V, Cr, Fe, and Rh). In the corundum structure, $2/3$ of the octahedral cavities in the hcp array of oxygen atoms are occupied by M^{3+} . Of the two forms of alumina, Al_2O_3 , α alumina and γ alumina, α alumina takes the corundum structure and is very hard. It is unreactive to water or acids. Alumina is the principal component of jewelry, such as ruby and sapphire. Moreover, various **fine ceramics** (functional porcelain materials) utilizing the properties of α -alumina have been developed. On the other hand, γ alumina has a defective spinel-type structure, and it adsorbs water and dissolves in acids, and is the basic component of activated alumina. It has many chemical uses including as a catalyst, a catalyst support, and in chromatography.

MO_3 type oxides

Rhenium and tungsten oxides are important compounds with this composition. **Rhenium trioxide**, ReO_3 , is a dark red compound prepared from rhenium and oxygen that has a metallic luster and conductivity. ReO_3 has a three-dimensional and very orderly array of ReO_6 regular, corner-sharing octahedra (Fig. 4.14).

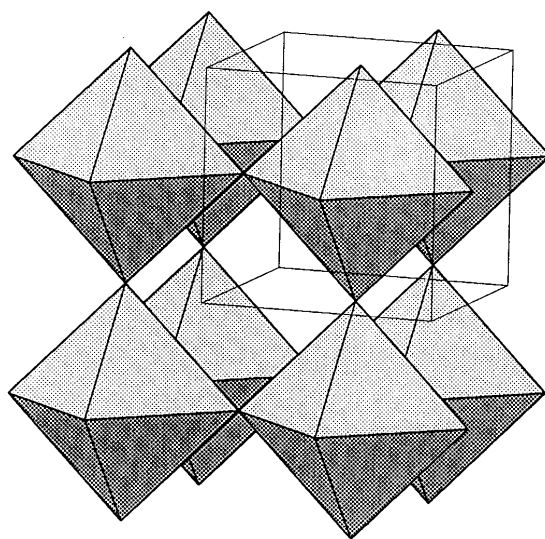

Fig. 4.14 Structure of ReO_3 .

Tungsten trioxide, WO_3 , is the only oxide that shows various phase transitions near room temperature and at least seven polymorphs are known. These polymorphs have the ReO_3 -type three-dimensional structure with corner-sharing WO_6 octahedra. When these compounds are heated in a vacuum or with powdered tungsten, reduction takes place and many oxides with complicated compositions ($\text{W}_{18}\text{O}_{49}$, $\text{W}_{20}\text{O}_{58}$, *etc.*) are formed. Similar molybdenum oxides are known and they had been regarded as non-stoichiometric compounds before A. Magneli found that they were in fact stoichiometric compounds.

Mixed metal oxides

Spinel, MgAl_2O_4 , has a structure in which Mg^{2+} occupy 1/8 of the tetrahedral cavities and Al^{3+} 1/2 of the octahedral cavities of a ccp array of oxygen atoms (Fig. 4.15) Among the oxides of composition $\text{A}^{2+}\text{B}_2^{3+}\text{O}_4$ (A^{2+} are Mg, Cr, Mn, Fe, Co, Ni, Cu, Zn, Cd, Sn, and B^{3+} are Al, Ga, In, Ti, V, Cr, Mn, Fe, Co, Ni, and Rh), those in which the tetrahedral holes are occupied by A^{2+} or B^{3+} are called **normal spinels** or **inverse spinels**, respectively. Spinel itself has a normal spinel-type structure, and MgFe_2O_4 and Fe_3O_4 have inverse spinel-type structures. Crystal field stabilization energies (refer to Section 6.2 (a)) differ depending on whether the crystal field of the oxygen atoms is a regular tetrahedron or octahedron. Therefore, when the metal component is a transition metal, the energy difference is one of the factors to determine which of A^{2+} or B^{3+} is favorable to fill the tetrahedral cavities.

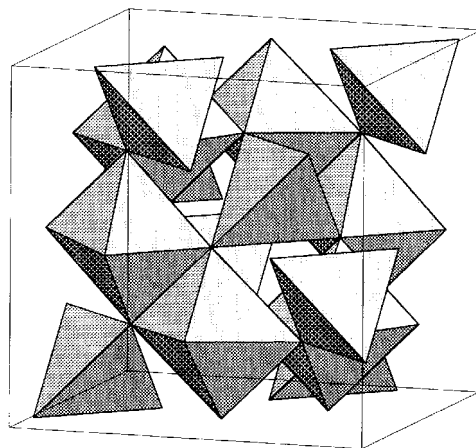

Fig. 4.15 Spinel structure.

Perovskite, CaTiO_3 , is an ABO_3 oxide (the net charge of A and B becomes $6+$), and it has a structure with calcium atom at the center of TiO_3 in the ReO_3 structure (Fig. 4.16). Among this kind of compounds, BaTiO_3 , commonly called barium titanate, is especially important. This ferroelectric functional material is used in nonlinear resistance devices (varistor).

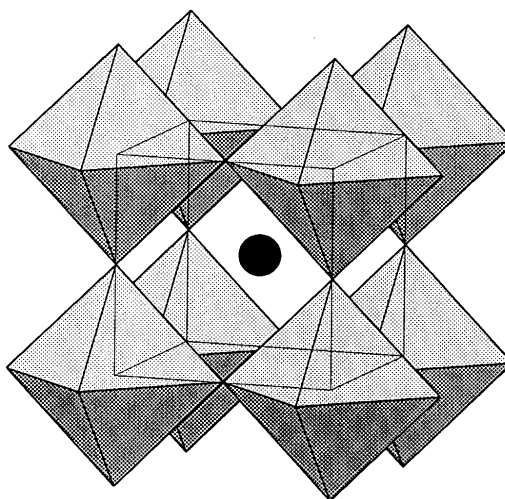

Fig. 4.16 Perovskite structure.

(h) Oxides of Group 14 elements

Although GeO_2 has a rutile-type structure, there is also a β quartz-type

polymorphism. There are germanium oxides with various kinds of structures analogous to silicates and aluminosilicates. SnO_2 takes a rutile-type structure. SnO_2 is used in transparent electrodes, catalysts, and many other applications. Surface treatment with tin oxide enhances heat reflectivity of glasses. PbO_2 usually has a rutile-type structure. Lead oxide is strongly oxidizing and used for the manufacture of chemicals, and PbO_2 forms in a lead batteries.

(i) Isopolyacids, heteropolyacids, and their salts

There are many polyoxo acids and their salts of Mo(VI) and W (VI). V (V), V (IV), Nb (V), and Ta (V) form similar polyoxo acids although their number is limited. **Polyoxoacids** are polynuclear anions formed by polymerization of the MO_6 coordination polyhedra that share corners or edges. Those consisting only of metal, oxygen, and hydrogen atoms are called **isopolyacids** and those containing various other elements (P, Si, transition metals, *etc.*) are called **heteropolyacids**. The salts of polyacids have counter-cations such as sodium or ammonium instead of protons. The history of polyoxoacids is said to have started with J. Berzelius discovering the first polyoxoacid in 1826, with the formation of yellow precipitates when he acidified an aqueous solution containing Mo (VI) and P (V). The structures of polyoxoacids are now readily analyzed with single crystal X-ray structural analysis, ^{17}O NMR, *etc.* Because of their usefulness as industrial catalysts or for other purposes, polyoxoacids are again being studied in detail.

Keggin-structure. The **heteropolyoxo** anions expressed with the general formula $[\text{X}^{\text{n}+}\text{M}_{12}\text{O}_{40}]^{(8-\text{n})-}$ ($\text{M} = \text{Mo}, \text{W}$, and $\text{X} = \text{B}, \text{Al}, \text{Si}, \text{Ge}, \text{P}, \text{As}, \text{Ti}, \text{Mn}, \text{Fe}, \text{Co}, \text{Cu}, \text{etc.}$) have the **Keggin structure**, elucidated by J. F. Keggin in 1934 using X-ray powder diffraction. For example, the structure of the tungstate ion containing silicon, in which 12 WO_6 octahedra enclose the central SiO_4 tetrahedron and four groups of three edge-shared octahedra connect to each other by corner sharing, is shown in Fig. 4.17. The four oxygen atoms that coordinate to the silicon atom of the SiO_4 tetrahedra also share three WO_6 octahedra. . Therefore, the whole structure shows T_d symmetry. Although the Keggin structure is somewhat complicated, it is very symmetrical and beautiful and is the most typical structure of heteropolyoxo anions. Many other types of heteropolyoxo anions are known.

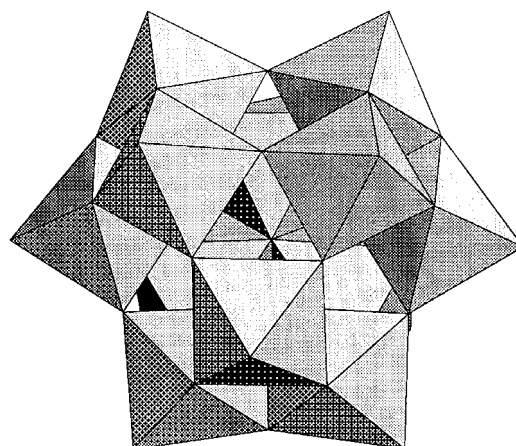
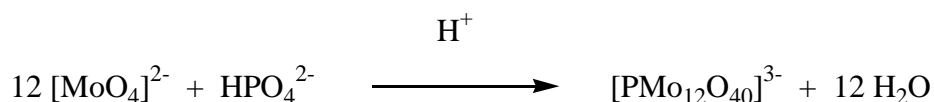

Fig. 4.17 Keggin structure.

Polyoxo anions are generated by the condensation of MO_6 units by removal of H_2O when MoO_4^{2-} reacts with a proton H^+ , as is shown in the following equation.



Therefore, the size and form of heteropolyoxo anions in the crystal precipitation are decided by the choice of acid, concentration, temperature, or the counter cation for crystallization. A number of studies on the solution chemistry of dissolved anions have been performed.

Heteropolyoxo anions display notable oxidizing properties. As heteropolyoxo anions contain metal ions of the highest oxidation number, they are reduced even by very weak reducing agents and show mixed valence. When Keggin-type anions are reduced by one electron, they show a very deep-blue color. It has been proved that the Keggin structure is preserved at this stage and polyoxo anions absorb more electrons and several M(V) sites are generated. Thus, a heteropolyoxo anion can serve as an electron sink for many electrons, and heteropolyoxo anions exhibit photo-redox reactions.

Exercise 4.4. What is the major difference in the structures of a polyacid and a solid acid?

[Answer] Although polyacids are molecules with definite molecular weights, the usual

solid oxides have an infinite number of metal-oxygen bonds.

4.4 Chalcogen and chalcogenides

(a) Simple substances

Sulfur, selenium, and tellurium are called chalcogens. Simple substances and compounds of oxygen and of the elements of this group in the later periods have considerably different properties. As a result of having much smaller electronegativities than oxygen, they show decreased ionicity and increased bond covalency, resulting in a smaller degree of hydrogen bonding. Because they have available *d* orbitals, chalcogens have increased flexibility of valence and can easily bond to more than two other atoms.

Catenation is the bonding between the same chalcogen atoms, and both simple substances and ions of chalcogens take a variety of structures.

The major isotopes of sulfur are ^{32}S (95.02% abundance), ^{33}S (0.75%), ^{34}S (4.21%), and ^{36}S (0.02%), and there are also six radioactive isotopes. Among these, ^{33}S ($I = 3/2$) can be used for NMR. Since the isotope ratio of sulfurs from different locations differs, the accuracy of the atomic weight is limited to 32.07 ± 0.01 . Because the electronegativity of sulfur ($\chi = 2.58$) is much smaller than that of oxygen ($\chi = 3.44$) and sulfur is a soft element, the ionicity in the bonds of sulfur compounds is low and hydrogen bonding is not important. Elemental sulfur has many allotropes, such as S_2 , S_3 , S_6 , S_7 , S_8 , S_9 , S_{10} , S_{11} , S_{12} , S_{18} , S_{20} , and S_∞ , reflecting the catenation ability of sulfur atoms.

Elemental sulfur is usually a yellow solid with a melting point of 112.8°C called orthorhombic sulfur (α sulfur). Phase-transition of this polymorph produces monoclinic sulfur (β sulfur) at 95.5°C . It was established in 1935 that these are crown-like cyclic molecules (Fig. 4.18). Being molecular, they dissolve well in organic solvents, such as CS_2 . Not only 8-membered rings but also S_{6-20} rings are known, and the helix polymer of sulfur is an infinitely annular sulfur. Diatomic molecular S_2 and triatomic molecular S_3 exist in the gaseous phase. When sulfur is heated, it liquifies and becomes a rubber-like macromolecule on cooling. The diversity of structures of catenated sulfur is also seen in the structures of the polysulfur cations or anions resulting from the redox reactions of the catenated species.

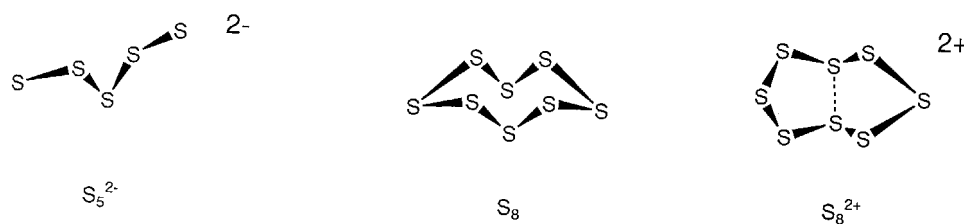

Fig. 4.18 Structures of S_5^{2-} , S_8 , and S_8^{2+} .

Selenium is believed to have six isotopes. ^{80}Se (49.7%) is the most abundant and ^{77}Se , with nuclear spin $I = 1/2$ is useful in NMR. The accuracy of atomic weight of selenium, $78.96+0.03$, is limited to two decimal places because of composition change of its isotopes. Among many allotropes of selenium, so-called red selenium is an Se_8 molecule with a crown-like structure and is soluble in CS_2 . Gray metallic selenium is a polymer with a helical structure. Black selenium, which is a complicated polymer, is also abundant.

Tellurium also has eight stable isotopes and an atomic weight of $127.60+0.03$.

^{130}Te (33.8%) and ^{128}Te (31.7%) are the most abundant isotopes, and ^{125}Te and ^{123}Te with $I = 1/2$ can be used in NMR. There is only one crystalline form of tellurium, which is a spiral chain polymer that shows electric conductivity.

(b) Polyatomic chalcogen cations and anions

Although it has long been recognized that solutions of chalcogen elements in sulfuric acid showed beautiful blue, red, and yellow colors, the polycationic species that give rise to these colors, S_4^{2+} , S_6^{2+} , S_6^{4+} , S_8^{2+} , S_{10}^{2+} , S_{19}^{2+} , or those of other chalcogen atoms, have been isolated by the reaction with AsF_5 , *etc.* and their structures determined. For example, unlike neutral S_8 , S_8^{2+} takes a cyclic structure that has a weak coupling interaction between two transannular sulfur atoms (Fig. 4.18).

On the other hand, alkali metal salts Na_2S_2 , K_2S_5 , and alkaline earth metal salt BaS_3 , a transition-metal salt $[\text{Mo}_2(\text{S}_2)_6]^{2-}$, a complex $\text{Cp}_2\text{W}(\text{S}_4)$, *etc.* of polysulfide anions S_x^{2-} ($x = 1-6$), in which the sulfur atoms are bonded mutually have been synthesized and their structures determined. As is evident from the fact that elemental sulfur itself forms S_8 molecules, sulfur, unlike oxygen, tends to catenate. Therefore, formation of polysulfide ions, in which many sulfur atoms are bonded, is feasible, and a series of polysulfanes H_2S_x ($x = 2-8$) has actually been synthesized.

(c) Metal sulfides

Stratified disulfides, MS_2 , are important in transition metal sulfides. They show two types of structures. One has a metal in a triangular prismatic coordination environment, and the other has a metal in an octahedral coordination environment.

MoS_2 is the most stable black compound among the molybdenum sulfides. L. Pauling determined the structure of MoS_2 in 1923. The structure is constructed by laminating two sulfur layers between which a molybdenum layer is intercalated (Fig. 4.19). Alternatively, two sulfur layers are stacked and a molybdenum layer is inserted between them. Therefore, the coordination environment of each molybdenum is a triangular prism of sulfur atoms. Since there is no bonding interaction between sulfur layers, they can easily slide, resulting in graphite-like lubricity. MoS_2 is used as a solid lubricant added to gasoline, and also as a catalyst for hydrogenation reactions.

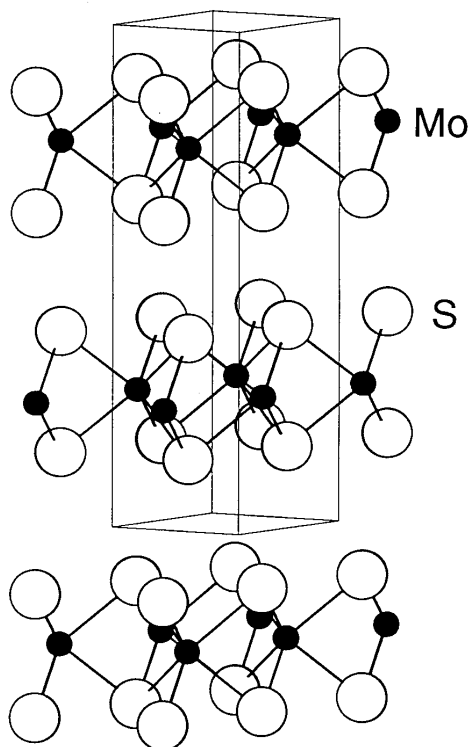

Fig. 4.19 Structure of MoS_2 .

ZrS_2 , TaS_2 , *etc.* take the CdI_2 type structure containing metal atoms in an octahedral coordination environment constructed by sulfur atoms.

Chevrel phase compounds. There are superconducting compounds called **Chevrel phases** which are important examples of the chalcogenide compounds of molybdenum. The general formula is described by $M_xMo_6X_8$ ($M = Pb, Sn, \text{ and } Cu; X = S, Se, \text{ and } Te$), and six molybdenum atoms form a regular octahedral cluster, and eight chalcogenide atoms cap the eight triangular faces of the cluster. The cluster units are connected 3-dimensionally (Fig. 4.20). Since the cluster structure of molybdenum atoms is similar to that of molybdenum dichloride, $MoCl_2$, ($= (Mo_6Cl_8)Cl_2Cl_{4/2}$), the structural chemistry of these compounds has attracted as much attention as their physical properties.

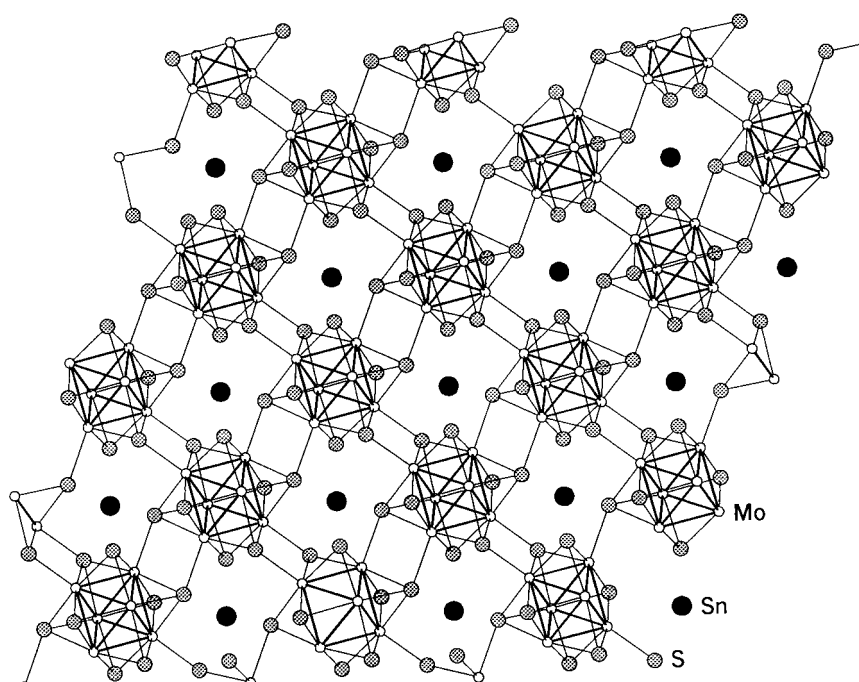

Fig. 4.20 Structure of $SnMo_6S_8$.

4.5 Halogens and halides

The origin of **halogen** is the Greek word meaning the production of salt by direct reaction with a metal. Since their reactivity is very high, halogens are found in nature only as compounds. The basic properties of halogens are shown in Table 4.6 and Table 4.7. The electron configuration of each halogen atom is ns^2np^5 , and they lack one electron from the closed-shell structure of a rare gas. Thus a halogen atom emits energy when it gains an electron. Namely, the enthalpy change of the reaction $X(g) + e^- \rightarrow X^-(g)$ is negative. Although electron affinity is defined as the energy change of gaining an

electron, a positive sign is customarily used. In order to be consistent with the enthalpy change, a negative sign would be appropriate.

Table 4.6 Properties of halogens

	Ionization energy (kJ mol ⁻¹)	Electronegativity χ_P	Ionic radius r(X ⁻) (pm)
F	1680.6	3.98	133
Cl	1255.7	3.16	181
Br	1142.7	2.96	196
I	1008.7	2.66	220

Table 4.7 Properties of halogen molecules

	Interatomic distance r(X-X) (pm)	mp °C	bp °C	Color
F ₂	143	-218.6	-188.1	Colorless gas
Cl ₂	199	-101.0	-34.0	Yellow green gas
Br ₂	228	-7.75	59.5	Dark red liquid
I ₂	266	113.6	185.2	Dark violet solid

The electron affinity of chlorine (348.5 kJmol⁻¹) is the largest and fluorine (332.6 kJmol⁻¹) comes between chlorine and bromine (324.7 kJmol⁻¹). The electronegativity of fluorine is the highest of all the halogens.

Since halogens are produced as metal salts, simple substances are manufactured by electrolysis. Fluorine only takes the oxidation number -1 in its compounds, although the oxidation number of other halogens can range from -1 to +7. Astatine, At, has no stable nuclide and little is known about its chemical properties .

(a) Manufacture of halogen

Fluorine has the highest reduction potential ($E^0 = +2.87$ V) and the strongest oxidizing power among the halogen molecules. It is also the most reactive nonmetallic element. Since water is oxidized by F₂ at much lower electrode potential (+1.23 V), fluorine gas cannot be manufactured by the electrolysis of aqueous solutions of fluorine compounds. Therefore, it was a long time before elemental fluorine was isolated, and F. H. Moisson finally succeeded in isolating it by the electrolysis of KF in liquid HF. Fluorine is still manufactured by this reaction.

Chlorine, which is especially important in inorganic industrial chemistry, is manufactured together with sodium hydroxide. The basic reaction for the production of chlorine is electrolysis of an aqueous solution of NaCl using an ion exchange process. In

this process, chlorine gas is generated in an anodic cell containing brine and Na^+ moves through an ion exchange membrane to the cathodic cell where it pairs with OH^- to become an aqueous solution of NaOH

Exercise 4.5 Why can chlorine be manufactured by electrolysis of an aqueous solution of sodium chloride?

[Answer] Despite the higher reduction potential of chlorine (+1.36 V) than that of oxygen (+1.23 V), the reduction potential of oxygen can be raised (overvoltage) depending on the choice of electrode used for the electrolysis process

Bromine is obtained by the oxidation of Br^- with chlorine gas in saline water. Iodine is similarly produced by passing chlorine gas through saline water containing I^- ions. Since natural gas is found in Japan together with underground saline water containing I^- , Japan is one of the main countries producing iodine.

Anomalies of fluorine Molecular fluorine compounds have very low boiling points. This is due to the difficulty of polarization as a result of the electrons being strongly drawn to the nuclei of fluorine atoms. Since the electronegativity of fluorine is highest ($\chi = 3.98$) and electrons shift to F, resulting in the high acidity of atoms bonded to F. Because of the small ionic radius of F^- , high oxidation states are stabilized, and hence low oxidation compounds like CuF are unknown, in contrast with the compounds such as IF_7 and PtF_6 .

Pseudohalogens Since the cyanide ion CN^- , the azide ion N_3^- , and the thiocyanate ion SCN^- , *etc.* form compounds similar to those of halide ions, they are called **pseudohalide ions**. They form pseudohalogen molecules such as cyanogen $(\text{CN})_2$, hydrogen cyanide HCN , sodium thiocyanate NaSCN , *etc.* Fine-tuning electronic and steric effects that are impossible with only halide ions make pseudohalogens useful also in transition metal complex chemistry.

Polyhalogens Besides the usual halogen molecules, mixed halogen and polyhalogen molecules such as BrCl , IBr , ICl , ClF_3 , BrF_5 , IF_7 *etc.* also exist. Polyhalogen anions and cations such as I_3^- , I_5^- , I_3^+ , and I_5^+ , are also known.

(b) Oxygen compounds

Although many binary oxides of halogens (consisting only of halogen and oxygen) are known, most are unstable. Oxygen difluoride OF_2 is the most stable such compound. This is a very powerful fluorinating agent and can generate plutonium hexafluoride PuF_6 from plutonium metal. While oxygen chloride, Cl_2O , is used for bleaching pulp and water treatment, it is generated *in situ* from ClO_3^- , since it is unstable.

Hypochlorous acid, HClO, chlorous acid, HClO₂, chloric acid, HClO₃, and perchloric acid, HClO₄ are oxoacids of chlorine and especially perchloric acid is a strong oxidizing agent as well as being a strong acid. Although analogous acids and ions of other halogens had been known for many years, BrO₄⁻ was synthesized as late as 1968. Once it was prepared it turned out to be no less stable than ClO₄⁻ or IO₄⁻, causing some to wonder why it had not been synthesized before. Although ClO₄⁻ is often used for crystallizing transition metal complexes, it is explosive and should be handled very carefully.

(c) Halides of nonmetals

Halides of almost all nonmetals are known, including fluorides of even the inert gases krypton, Kr, and xenon, Xe. Although fluorides are interesting for their own unique characters, halides are generally very important as starting compounds for various compounds of nonmetals by replacing halogens in inorganic syntheses (Table 4.8).

Table 4.8 Typical chlorides and fluorides of main group elements

	1	2	12	13	14	15	16	17	18
2	LiCl	BeCl ₂		BF ₃	CCl ₄	NF ₃	OF ₂		
3	NaCl	MgCl ₂		AlCl ₃	SiCl ₄	PCl ₃ PCl ₅	S ₂ Cl ₂ SF ₆	ClF ₃ ClF ₅	
4	KCl	CaCl ₂	ZnCl ₂	GaCl ₃	GeF ₂ GeCl ₄	AsCl ₃ AsF ₅	Se ₂ Cl ₂ SeF ₅	BrF ₃ BrF ₅	KrF ₂
5	RbCl	SrCl ₂	CdCl ₂	InCl InCl ₃	SnCl ₂ SnCl ₄	SbCl ₃ SbF ₅	Te ₄ Cl ₁₆ TeF ₆	IF ₅ IF ₇	XeF ₂ XeF ₆
6	CsCl	BaCl ₂	Hg ₂ Cl ₂ HgCl ₂	TlCl TlCl ₃	PbCl ₂ PbCl ₄	BiCl ₃ BiF ₅			

Boron trifluoride, BF₃, is a colorless gas (mp -127 °C and bp -100 °C) that has an irritating odor and is poisonous. It is widely used as an industrial catalyst for Friedel-Crafts type reactions. It is also used as a catalyst for cationic polymerization. It exists in the gaseous phase as a triangular monomeric molecule, and forms Lewis base adducts with ammonia, amines, ethers, phosphines, *etc.* because of its strong Lewis acidity. Diethylether adduct, (C₂H₅)₂O:BF₃, is a distillable liquid and is used as a common reagent. It is a starting compound for the preparation of diborane, B₂H₆. Tetrafluoroborate, BF₄⁻, is a tetrahedral anion formed as an adduct of BF₃ with a base F⁻. Alkali metal salts, a silver salt and NOBF₄ as well as the free acid HBF₄ contain this anion. Since its coordination ability is very weak, it is used in the crystallization of cationic complexes of transition metals as a counter anion like ClO₄⁻. AgBF₄ and NOBF₄ are also useful for 1-electron oxidation of complexes.

Tetrachlorosilane, SiCl₄, is a colorless liquid (mp -70 °C and bp 57.6 °C). It is a

regular tetrahedral molecule, and reacts violently with water forming silicic acid and hydrochloric acid. It is useful as a raw material for the production of pure silicon, organic silicon compounds, and silicones.

Phosphorus trifluoride, PF_3 , is a colorless, odorless, and deadly poisonous gas (mp $-151.5\text{ }^\circ\text{C}$ and bp $-101.8\text{ }^\circ\text{C}$). This is a triangular pyramidal molecule. Because it is as electron-attracting as CO, it acts as a ligand forming metal complexes analogous to metal carbonyls.

Phosphorus pentafluoride, PF_5 , is a colorless gas (mp $-93.7\text{ }^\circ\text{C}$ and bp $-84.5\text{ }^\circ\text{C}$). It is a triangular bipyramidal molecule and should have two distinct kinds of fluorine atoms. These fluorines exchange positions so rapidly that they are indistinguishable by ^{19}F NMR. It was the first compound with which the famous Berry's pseudorotation was discovered as an exchange mechanism for axial and equatorial fluorine atoms (refer to Section 6.1). The hexafluorophosphate ion, PF_6^- , as well as BF_4^- is often used as a counter anion for cationic transition metal complexes. LiPF_6 and R_4NPF_6 can be used as supporting electrolytes for electrochemical measurements.

Phosphorus trichloride, PCl_3 , is a colorless fuming liquid (mp $-112\text{ }^\circ\text{C}$ and bp $75.5\text{ }^\circ\text{C}$). It is a triangular pyramidal molecule and hydrolyzes violently. It is soluble in organic solvents. It is used in large quantities as a raw material for the production of organic phosphorus compounds.

Phosphorus pentachloride, PCl_5 , is a colorless crystalline substance (sublimes but decomposes at $160\text{ }^\circ\text{C}$) It is a triangular bipyramidal molecule in the gaseous phase, but it exists as an ionic crystal $[\text{PCl}_4]^+[\text{PCl}_6]^-$ in the solid phase. Although it reacts violently with water and becomes phosphoric acid and hydrochloric acid, it dissolves in carbon disulfide and carbon tetrachloride. It is useful for chlorination of organic compounds.

Arsenic pentafluoride, AsF_5 , is a colorless gas (mp $-79.8\text{ }^\circ\text{C}$ and bp $-52.9\text{ }^\circ\text{C}$). It is a triangular bipyramidal molecule. Although it hydrolyzes, it is soluble in organic solvents. As it is a strong electron acceptor, it can form electron donor-acceptor complexes with electron donors.

Sulfur hexafluoride, SF_6 , is a colorless and odorless gas (mp $-50.8\text{ }^\circ\text{C}$ and sublimation point $-63.8\text{ }^\circ\text{C}$) It is a hexacoordinate octahedral molecule. It is chemically very stable and hardly soluble in water. Because of its excellent heat-resisting property, incombustibility, and corrosion resistance, it is used as a high voltage insulator.

Sulfur chloride, S_2Cl_2 , is an orange liquid (mp $-80\text{ }^\circ\text{C}$ and bp $138\text{ }^\circ\text{C}$). It has a similar structure to hydrogen peroxide. It is readily soluble in organic solvents. It is important as an industrial inorganic compound, and is used in large quantities for the vulcanization of rubber *etc.*

(d) Metal halides

Many metal halides are made by the combination of about 80 metallic elements and four halogens (Table 4.8, Table 4.9). Since there are more than one oxidation state especially in transition metals, several kinds of halides are known for each transition metal. These halides are most important as starting materials of the preparation of metal compounds, and the inorganic chemistry of metal compounds depends on metal halides. There are molecular, 1-dimensional chain, 2-dimensional layer, and 3-dimensional halides but few of them are molecular in crystalline states. It should be noted that the anhydrous transition metal halides are usually solid compounds and hydrates are coordination compounds with water ligands. As the dimensionality of structures is one of the most interesting facets of structural or synthetic chemistry, typical halides are described in order of their dimensionality.

Table 4.9 Typical chlorides and fluorides of transition metals

Oxidation Number	3	4	5	6	7	8	9	10	11
+1	ScCl YCl LaCl	ZrCl HfCl							CuCl AgCl AuCl
+2		TiCl ₂	VCl ₂	CrCl ₂ MoCl ₂ WCl ₂	MnCl ₂	FeCl ₂ RuCl ₂	CoCl ₂	NiCl ₂ PdCl ₂ PtCl ₂	CuCl ₂
+3	ScF ₃ YCl ₃ LaF ₃	TiCl ₃ ZrCl ₃	VCl ₃	CrCl ₃ MoCl ₃ WCl ₃	ReCl ₃	FeCl ₃ RuCl ₃ OsCl ₃	CoF ₃ RhCl ₃ IrCl ₃		AuCl ₃
+4		TiCl ₄ ZrCl ₄ HfCl ₄	VCl ₄ NbCl ₄ TaCl ₄	CrF ₄ MoCl ₄ WCl ₄	ReCl ₄			PtCl ₄	
+5			VF ₅ NbCl ₅ TaCl ₅	CrF ₅ MoCl ₅ WCl ₅	ReCl ₅	OsF ₅	IrF ₅	PtF ₅	
+6				WCl ₆	ReF ₆	OsF ₆	IrF ₆	PtF ₆	
+7					ReF ₇	OsF ₇			

Molecular halides

Mercury(II) chloride, HgCl₂. It is a colorless crystal soluble in water and ethanol. It is a straight, three-atomic molecule in the free state. However, in addition to two chlorine atoms bonded to mercury, four additional chlorine atoms of adjacent molecules occupy coordination sites and the mercury is almost hexacoordinate in the crystalline state. The compound is very toxic and used for preserving wood, *etc.*

Aluminum trichloride, AlCl₃. A colorless crystal (mp 190 °C (2.5 atm) and bp 183

$^{\circ}\text{C}$) that sublimes when heated. It is soluble in ethanol and ether. It is a Lewis acid and forms adducts with various bases. It is a molecule consisting of the dimer of tetracoordinate aluminium with chlorine bridges in the liquid and gaseous phases (Fig. 4.21), and takes a lamellar structure when crystalline. It is used as a Lewis acid catalyst of Friedel-Crafts reactions, *etc.*

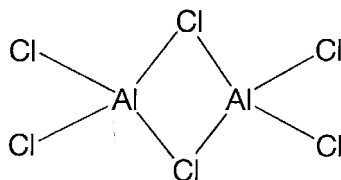

Fig. 4.21 Structure of aluminum chloride.

Tin (IV) chloride, SnCl_4 . A colorless liquid (mp $-33\text{ }^{\circ}\text{C}$ and bp $114\text{ }^{\circ}\text{C}$). In the gaseous state, it is a tetrahedral molecule.

Titanium(IV) chloride, TiCl_4 . A colorless liquid (mp $-25\text{ }^{\circ}\text{C}$ and bp $136.4\text{ }^{\circ}\text{C}$). The gaseous molecule is a tetrahedron similar to tin(IV) chloride. It is used as a component of the Ziegler Natta catalyst (refer to Section 8.1 (a)).

Chain-like halides

Gold (I) iodide, AuI . Yellow white solid. Two iodines coordinate to gold, and the compound has a zigzag 1-dimensional chain structure.

Beryllium chloride, BeCl_2 . A colorless crystal (mp $405\text{ }^{\circ}\text{C}$ and bp $520\text{ }^{\circ}\text{C}$). It is deliquescent and soluble in water and ethanol. The tetra-coordinated beryllium forms a 1-dimensional chain via chlorine bridges (Fig. 4.22). In the gaseous phase, it is a straight two-coordinate molecule. It is a Lewis acid and is used as a catalyst for Friedel-Crafts reactions.

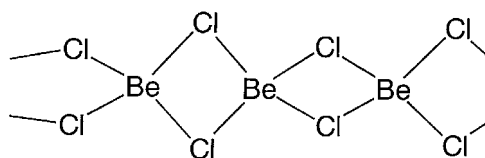

Fig. 4.22 Structure of beryllium chloride.

Palladium chloride, PdCl_2 . A dark red solid. In the α type, the four-coordinate palladium forms a 1-dimensional chain with double bridges of chlorines. The dihydrate

is deliquescent and soluble in water, ethanol, acetone, *etc.* When it is dissolved in hydrochloric acid, it becomes four-coordinate square-planar $[\text{PdCl}_4]^{2-}$. It is used as the catalyst for the Wacker process, which is an olefin oxidation process, or in various catalysts for organic syntheses.

Zirconium tetrachloride, (IV) ZrCl_4 . A colorless crystal (it sublimes above 331 °C). The zirconium is octahedrally coordinated and forms a zigzag chain via chlorine bridges (Fig. 4.23). It is hygroscopic and soluble in water, ethanol, *etc.* It is used as a Friedel-Crafts catalyst and as a component of olefin polymerization catalysts.

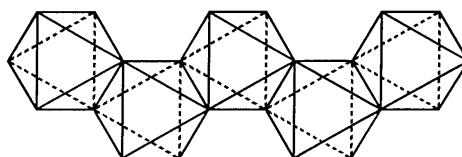

Fig. 4.23 Structure of zirconium tetrachloride.

Stratified halides

Cadmium iodide, CdI_2 . A colorless crystal (mp 388 °C and bp 787 °C). It has a cadmium iodide structure where the layers of edge-shared CdI_6 octahedral units are stratified (Fig. 4.24). In the gaseous phase, it comprises straight three atomic molecules. It dissolves in water, ethanol, acetone, *etc.*

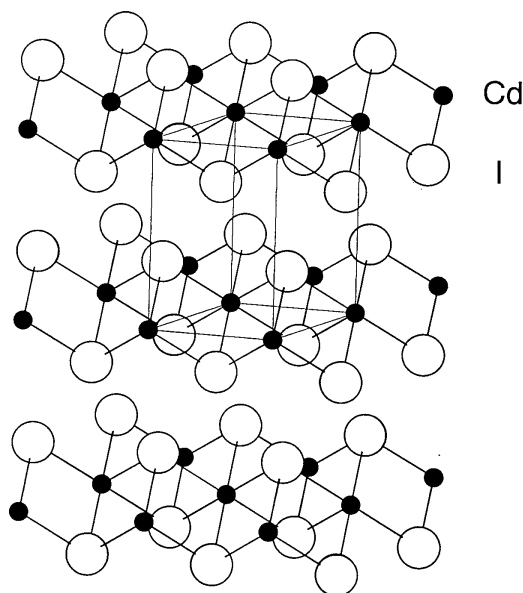

Fig. 4.24 Layers of cadmium and iodine in the cadmium iodide structure.

Cobalt(II) chloride, CoCl_2 . Blue crystals (mp 735 °C and bp 1049 °C). It has the

cadmium chloride structure. It is hygroscopic and becomes light red when water is absorbed. It is soluble also in ethanol and acetone. The hexahydrate is red and is a coordination compound in which water molecules are ligands.

Iron (II)chloride, FeCl_2 . Greenish yellow crystals (mp 670-674 °C). It has the cadmium chloride structure, and is soluble in water and ethanol. The hydrates, which are coordinated by various numbers (6, 4, 2) of water molecules, are precipitated from aqueous solutions of hydrochloric acid.

Iron(III) chloride, FeCl_3 . Dark brown crystals (mp 306 °C and sublimes). It has a lamellar structure in which iron is octahedrally surrounded by six chlorine ligands. In the gaseous phase, it has a dimeric structure bridged by chlorine atoms similar to that of aluminum chloride.

3-dimensional structure halides

Sodium chloride, NaCl . A colorless crystal (mp 801 °C and bp 1413 °C). It is the original rock salt-type structure. In the gaseous phase, this is a two-atom molecule. Although it is soluble in glycerol as well as water, it hardly dissolves in ethanol. Large single crystals are used as prisms for infrared spectrometers.

Cesium chloride, CsCl . A colorless crystal (mp 645 °C, bp 1300 °C). Although it has the cesium chloride type structure, it changes to the rock salt structure at 445 °C. In the gaseous phase, it is a two-atom molecule.

Copper(I) chloride, CuCl . A colorless crystal (mp 430 °C and bp 1490 °C) It has the zinc blende structure and four chlorines tetrahedrally coordinate to copper.

Calcium chloride, CaCl_2 . A colorless crystal (mp 772 °C and bp above 1600 °C). It has a deformed rutile-type structure and calcium is octahedrally surrounded by six chlorines. It is soluble in water, ethanol, and acetone. It is deliquescent and used as a desiccant. Hydrates in which 1, 2, 4, or 6 water molecules are coordinated are known.

Calcium fluoride, CaF_2 . A colorless crystal (mp 1418 °C and bp 2500 °C). It has the fluorite type structure. It is the most important raw material for fluorine compounds. Good quality crystals are used also as spectrometer prisms and in photographic lenses.

Chromium(II) chloride, CrCl_2 . A colorless crystal (mp 820 °C and sublimes). It has a deformed rutile-type structure. It dissolves well in water giving a blue solution.

Chromium(III) chloride, CrCl_3 . Purplish red crystal (mp 1150 °C and decomposes at 1300 °C). Cr^{3+} occupies two thirds of the octahedral cavities in every other layer of Cl^- ions, which are hexagonally close-packed. It is insoluble in water, ethanol, and acetone.

Exercise 4.6 Why do solid metal halides dissolve in water?

[Answer] It is because water reacts with halides breaking the halogen bridges in the solid structures and coordinates to the resultant molecular complexes.

4.6 Rare gases and their compounds

(a) Rare gases

In the 18th century, H. Cavendish discovered an inert component in air. In 1868, a line was discovered in the spectrum of sunlight that could not be identified and it was suggested to be due to a new element, helium. Based on these facts, at the end of the 19th century W. Ramsay isolated He, Ne, Ar, Kr, and Xe and by studying their properties demonstrated that they were new elements. In spite of the nearly 1% content of argon Ar in air, the element had not been isolated until then and rare gases were completely lacking in Mendeleev's periodic table. The Nobel prize was awarded to Ramsay in 1904 for his achievement.

Rare gases are located next to the halogen group in the periodic table. Since rare gas elements have closed-shell electronic configurations, they lack reactivity and their compounds were unknown. Consequently, they were also called inert gases. However, after the discovery of rare gas compounds, it was considered more suitable to call these elements "noble gases", as is mentioned in the following chapter.

Although the abundance of helium in the universe is next to that of hydrogen, it is very rare on the Earth because it is lighter than air. Helium originated from solar nuclear reactions and was locked up in the earth's crust. It is extracted as a by-product of natural gas from specific areas (especially in North America). Since helium has the lowest boiling point (4.2 K) of all the substances, it is important for low-temperature science and superconductivity engineering. Moreover, its lightness is utilized in airships *etc.* Since argon is separated in large quantities when nitrogen and oxygen are produced from liquid air, it is widely used in metallurgy, and in industries and laboratories that require an oxygen-free environment.

(b) Rare gas compounds

Xenon, Xe, reacts with elements with the largest electronegativities, such as fluorine, oxygen, and chlorine and with the compounds containing these elements, like platinum fluoride, PtF₆. Although the first xenon compound was reported (1962) as XePtF₆, the discoverer, N. Bartlett, later corrected that it was not a pure compound but a mixture of Xe[PtF₆]_x (x= 1-2). If this is mixed with fluorine gas and excited with heat or light, fluorides XeF₂, XeF₄, and XeF₆ are generated. XeF₂ has chain-like, XeF₄ square, and XeF₆ distorted octahedral structures. Although preparation of these compounds is

comparatively simple, it is not easy to isolate pure compounds, especially XeF_4 .

Hydrolysis of the fluorides forms oxides. XeO_3 is a very explosive compound. Although it is stable in aqueous solution, these solutions are very oxidizing. Tetroxide, XeO_4 , is the most volatile xenon compound. $\text{M}[\text{XeF}_8]$ (M is Rb and Cs) are very stable and do not decompose even when heated at $400\text{ }^\circ\text{C}$. Thus, xenon forms divalent to octavalent compounds. Fluorides can also be used as fluorinating reagents.

Although it is known that krypton and radon also form compounds, the compounds of krypton and radon are rarely studied as both their instability and their radioactivity make their handling problematic.

Discovery of rare gas compounds

H. Bartlett studied the properties of platinum fluoride PtF_6 in the 1960s, and synthesized O_2PtF_6 . It was an epoch-making discovery in inorganic chemistry when analogous experiments on xenon, which has almost equal ionization energy (1170 kJmol^{-1}) to that of O_2 (1180 kJmol^{-1}), resulted in the dramatic discovery of XePtF_6 .

Rare gas compounds had not been prepared before this report, but various attempts were made immediately after the discovery of rare gases. W. Ramsay isolated rare gases and added a new group to the periodic table at the end of the 19th century. Already in 1894, F. F. H. Moisson, who is famous for the isolation of F_2 , reacted a 100 cm^3 argon offered by Ramsay with fluorine gas under an electric discharge but failed to prepare an argon fluoride. At the beginning of this century, A. von Antropoff reported the synthesis of a krypton compound KrCl_2 , but later he concluded that it was a mistake.

L. Pauling also foresaw the existence of KrF_6 , XeF_6 , and H_4XeO_6 , and anticipated their synthesis. In 1932, a post doctoral research fellow, A. L. Kaye, in the laboratory of D. M. L. Yost of Caltech, where Pauling was a member of faculty, attempted to prepare rare gas compounds. Despite elaborate preparations and eager experiments, attempts to prepare xenon compounds by discharging electricity through a mixed gas of xenon, fluorine, or chlorine were unsuccessful. It is said that Pauling no longer showed interest in rare gas compounds after this failure.

Although R. Hoppe of Germany predicted using theoretical considerations that the existence of XeF_2 and XeF_4 was highly likely in advance of the discovery of Bartlett, he prepared these compounds only after knowing of Bartlett's discovery. Once it is proved that a compound of a certain kind is stable, analogous compounds are prepared one after another. This has also been common in synthetic chemistry of the later period, showing the importance of the first discovery.

Problem

- 4.1** Write a balanced equation for the preparation of diborane.
- 4.2** Write a balanced equation for the preparation of triethylphosphine.
- 4.3** Write a balanced equation for the preparation of osmium tetroxide.
- 4.4** Describe the basic reaction of the phosphomolybdate method used for the detection of phosphate ions.
- 4.5** Draw the structure of anhydrous palladium dichloride and describe its reaction when dissolved in hydrochloric acid.
- 4.6** Describe the reaction of anhydrous cobalt dichloride when it is dissolved in water.
- 4.7** Draw the structure of phosphorus pentafluoride.

5 Chemistry of Main-Group Metals

Metals show metallic luster, are good conductors of electricity and heat, and are very malleable and ductile. Such properties are characteristic of bulk metals, although the definition of metal atoms or ions is not simple. Metallic elements form basic oxides or hydroxides in the +1 or +2 oxidation states, and become cations in aqueous acid solutions. All transition elements are metals, but main group elements are classified into metallic and nonmetallic elements. Germanium and polonium may also be included as metals. Boron, silicon, germanium, arsenic, antimony, selenium, and tellurium exhibit some metallic characteristics and they are sometimes called metalloids.

5.1 Group 1 metals

Group 1 metals are called **alkali metals**. Alkali metals are abundant in minerals and sea water. Especially the content of sodium, Na, in the Earth's crust is fourth after Al, Fe, and Ca. Although the existence of sodium or potassium ions was recognized for many years, a number of attempts to isolate the metals from aqueous solutions of their salts failed because of their high reactivity with water. Potassium (1807) and subsequently sodium were isolated by the electrolysis of molten salt of KOH or NaOH by H. Davy in the 19th century. Lithium Li was discovered as a new element (1817), and Davy soon isolated it by molten salt electrolysis of Li_2O . Rubidium, Rb and Cesium, Cs, were discovered as new elements by spectroscopy in 1861. Francium, Fr, was discovered using a radiochemical technique in 1939. Its natural abundance is very low.

Table 5.1 Properties of group 1 metals

	mp (°C)	bp (°C)	d(20 °C) (g cm ⁻³)	E ⁰ (V) M ⁺ +e ⁻	I (kJ mol ⁻¹)
Li	181	1342	0.534	-3.04	520
Na	98	883	0.968	-2.71	496
K	63	759	0.856	-2.93	419
Rb	39	688	1.532	-2.98	403
Cs	28	671	1.90	-3.03	376

As shown in Table 5.1, melting-points, boiling points, and densities of alkali metals are low, and they are soft metals. Since the outer shell contains only one *s*-electron, the

ionization energy is very low, and mono cations of alkali metals form easily. Qualitative analysis of alkali metals is possible by means of flame reactions using characteristic luminescence lines. Especially the orange D-line of sodium is used in the sodium lamp. Alkali metals are oxidized by water evolving hydrogen gas due to their low reduction potentials. Except lithium, the heavier alkali metals react violently with water, and sufficient caution should be exercised in their handling.

Exercise 5.1 Describe the reactivity of alkali metals in water.

[Answer] The reactivity of lithium is the lowest, sodium reacts violently, and potassium, rubidium, and cesium react explosively.

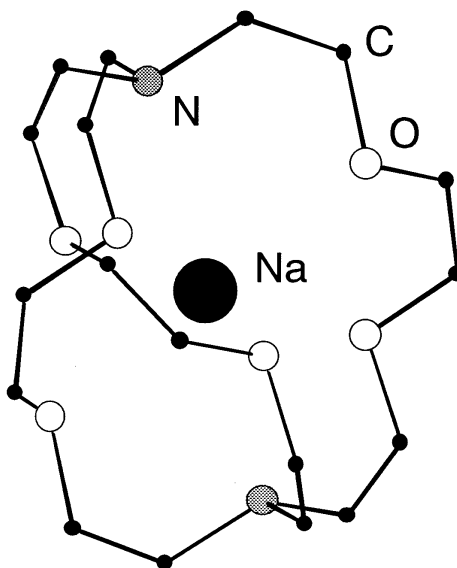
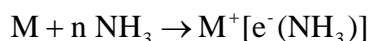

Fig. 5.1 Structure of Na(crypt).

Alkali metals are also highly reactive to oxygen or halogens. As alkali metals are very reducing, they are used widely as reducing agents. Because of the high affinity of alkali metals to halogens, they are important in organic and inorganic syntheses which produce alkali metal halides as the result of condensation and metathesis reactions. Although it is generally difficult to dissolve metals in solvents to make atomic dispersions, alkali metals can be dispersed in liquid ammonia solutions, amalgams, and as cryptand (Fig. 5.1), naphthalene, or benzophenone (C_6H_5)₂CO complexes.

Ammonia boils at $-33.35\text{ }^\circ\text{C}$ but liquid ammonia can be easily handled. Alkali metals dissolve readily in liquid ammonia and dilute solutions are blue but concentrated ones show a bronze color. The metal is recovered when ammonia is evaporated from

metal solutions. Alkali metal solutions show the same color irrespective of the kind of alkali metals as the color is due to the solvated electrons. Namely, the dissolution is accompanied by the separation of the alkali metal atoms into metal cations and electrons solvated by ammonia, according to the following equation.



The liquid ammonia solution of an alkali metal is conductive and paramagnetic. The highly reducing solution is used for special reduction reactions or syntheses of alkali metal complexes and polyhalides.

5.2 Group 2 metals

Group 2 metals from beryllium Be, to radium, Ra, are also called **alkaline earth metals** (Table 5.2). Beryllium is a component of beryl or emerald. Emerald is a mineral that contains about 2% of chromium, Cr, in beryl, $\text{Be}_3\text{Al}_2\text{Si}_6\text{O}_{18}$. Beryllium metal is silver white and is used in special alloys and for the window of X-ray tubes, or a moderator of nuclear reactors, *etc.* Compounds of Be^{2+} resemble the compounds of Mg^{2+} or Al^{3+} . Since beryllium is a deadly poison, it should be handled with due care.

Table 5.2 Properties of group 2 metals

	mp (°C)	bp (°C)	$d(20\text{ °C})$ (g cm ⁻³)	$E^0(\text{V})$ $\text{M}^{2+}+2\text{e}^-$	I (kJ mol ⁻¹)	
					first	second
Be	1287	2471	1.85	-1.85	899	1757
Mg	650	1090	1.74	-2.37	737	1450
Ca	842	1484	1.55	-2.87	590	1145
Sr	777	1382	2.63	-2.90	549	1064
Ba	727	1897	3.62	-2.91	503	965
Ra	700		5.5	-2.82	509	975

Magnesium, Mg, is mainly produced as carbonates, sulfates, and silicates, and its abundance is between those of sodium and calcium, Ca. It is produced by molten salt electrolysis of magnesium chloride, MgCl_2 , or the reaction of dolomite, $\text{CaMg}(\text{CO}_3)_2$, with ferrosilicon alloy FeSi. Magnesium metal is silver white and the surface is oxidized in air. At high temperatures, magnesium reacts with nitrogen gas to become nitride, Mg_3N_2 . The metal burns very brightly and is still used for flash lights. The alloy with aluminum is light and strong and used as a structural material in cars and airplanes.

Mg^{2+} is the central metal ion in the porphyrin ring of chlorophyll, and plays an

important role in photosynthesis. The Grignard reagent, RMgX , which F. A. V. Grignard of France synthesized in 1900, is a typical organometallic compound of a main-group metal and is widely used for Grignard reactions. This is an important reagent rewarded by a Nobel prize (1912), and is very useful not only for organic reactions but also for the conversion of metal halides into organometallic compounds.

Calcium is contained in silicates, carbonates, sulfates, phosphates, fluorite, *etc.* Calcium is a silver white and soft metal that is manufactured by molten salt electrolysis of calcium chloride CaCl_2 .

Quick lime, CaO , is produced by the calcination of limestone, CaCO_3 , at 950-1100 °C. Production of quick lime ranks second to sulfuric acid in inorganic chemical industries. Calcium hydroxide, Ca(OH)_2 , is called also slaked lime. Calcium carbonate is the principal component of limestone and limestone is very important for the production of cement. Gypsum is a dihydrate of calcium sulfate $\text{CaSO}_4 \cdot 2\text{H}_2\text{O}$ and is obtained in large quantities as a by-product of stack gas desulfurization, and in addition to conventional uses is also used as a building material, *etc.*

Although calcium is not important in either the chemistry of aqueous solution systems or in organometallic chemistry in organic solvents, the element plays very important roles in living organisms. Not only is calcium the structure material of bones and teeth, calcium ions also have a wide range of functions in biological systems, such as protein stabilization, transfer of hormone action, muscular contraction, nerve communication, and blood coagulation.

Strontium, Sr, is a silver white soft metal. The surface is oxidized by air at room temperature, and it becomes a mixture of oxide, SrO , and nitride, Sr_3N_2 , at high temperatures. In spite of the relatively high content of strontium in the Earth's crust, the element has not been studied widely and its application is limited. There are four natural isotopes and ^{88}Sr (82.58%) is the most abundant. Since the artificial isotope ^{90}Sr is obtained cheaply by nuclear reaction, it is used as a source of β particles, and as a radioactive tracer. However, this isotope, as well as ^{137}Cs , has a long half-life (28.8 y) and both are present in the radioactive fallout that accompanies nuclear explosive tests. Both are considered to be very dangerous.

The chemistry of barium, Ba, is unexceptional but BaSO_4 is used as a contrast medium for X-ray diagnosis of the stomach because it is insoluble in hydrochloric acid. The Ba^{2+} ion is highly toxic and water-soluble compounds containing the ion should be handled cautiously.

Although radium, Ra, exists in uranium ores, the content is as low as 10^{-6} times that of uranium, U. Mr. and Mrs. Curie isolated a trace quantity of uranium chloride from tons of pitchblende in 1898. Elemental uranium was also isolated by Mrs. Curie via an

amalgam. Although radium has historical importance in radiochemistry, it is no longer used as a radiation source.

Exercise 5.2 Show examples of main group organometallic compounds which are often used in synthetic chemistry.

[Answer] Butyl lithium, LiBu, Grignard reagent, RMgBr, triethylaluminum, AlEt₃, and diethyl zinc ZnEt₂.

5.3 Group 12 metals

Sulfide ores of zinc, Zn, cadmium, Cd, and mercury, Hg, of Group 12 metals (Table 5.3) serve as raw materials in metallurgy. These metals are located immediately after the transition metals in the periodic table but they do not behave like transition metals because their *d* orbitals are filled, and zinc and cadmium exhibit properties intermediate between hard and soft reactivities of magnesium. Mercury is soft and a liquid and it tends to bond to phosphorus or sulfur ligands. Mercury forms monovalent and divalent compounds but monovalent mercury is actually Hg₂²⁺. This is a cationic species which has a Hg-Hg bond, and mercury further catenates to give, for example, Hg₄(AsF₆)₂.

Table 5.3 Properties of group 12 metals

	mp	bp	<i>d</i> (25 °C)	<i>E</i> ⁰ (V)	<i>I</i> (kJ mol ⁻¹)		
	(°C)	(°C)	(g cm ⁻³)	M ²⁺ +2e ⁻	first	second	third
Zn	420	907	7.14	-0.76	906	1733	3831
Cd	321	767	8.65	-0.40	877	1631	3644
Hg	-38.8	357	13.5	0.85	1007	1809	3300

Cadmium and mercury are poisonous, especially organic cadmium and organic mercury compounds are deadly poisons and should be handled carefully.

5.4 Group 13 metals

Aluminum, Al, among Group 13 metals (Table 5.4) exists as aluminosilicates in the Earth's crust and is more abundant than iron. The most important mineral for metallurgy is bauxite, AlO_x(OH)_{3-2x} (0 < x < 1). Although the Al metal was as valuable as noble metals in the 19th century, the price fell dramatically after it came to be manufactured in large quantities by electrolysis of alumina, Al₂O₃, melted in cryolite, Na₃AlF₆. However, because its production requires consumption of a large amount of electrical power, the metallurgy of aluminum is economically feasible only in countries where the price of

electrical power is low. Therefore, Japan has withdrawn from aluminum smelting, but Japan's consumption of the metal is second only to the United States. The properties of aluminum are well known as it is widely used and encountered in every day life, for example in one-yen coins, aluminum foil, cooking pans, aluminum window sashes, *etc.* Aluminum metal usually exceeds 99% purity, and the metal itself and its alloys, like duralumin, are widely used.

Table 5.4 Properties of group 13 metals

	mp	bp	$d(20\text{ }^\circ\text{C})$	$E^0(\text{V})$	$I(\text{kJ mol}^{-1})$		
	($^\circ\text{C}$)	($^\circ\text{C}$)	(g cm^{-3})	$\text{M}^{3+}+3\text{e}^-$	first	second	third
Al	660	2519	2.70	-1.66	577	1816	2744
Ga	29.8	2204	5.90	-0.55	579	1979	2962
In	157	2072	7.31	-0.34	558	1820	2704
Tl	304	1473	11.9	+0.74	589	1971	2877

Aluminum metal dissolves in mineral acids, except concentrated nitric acid, and in aqueous solutions of alkali metal hydroxides evolving hydrogen. Aluminum forms compounds with most nonmetallic elements and shows a rich chemistry, but unlike boron, no cluster hydrides are known. As oxide and halides have already been described (4.3 (c), 4.5 (d)), organo-aluminum compounds will be mentioned here.

Organoaluminum compounds

Organoaluminum compounds are used in large quantities for olefin polymerization, and they are industrially manufactured from aluminum metal, hydrogen, and an olefin as follows.



They are dimers except those with bulky hydrocarbyl groups. For example, trimethylaluminum, $\text{Al}_2(\text{CH}_3)_6$, is a dimer in which methyl groups bridge aluminum atoms by electron deficient bonds (Fig. 5.2). Organoaluminum compounds are very reactive and burn spontaneously in air. They react violently with water and form saturated hydrocarbons, with aluminium changing to aluminium hydroxide as follows.

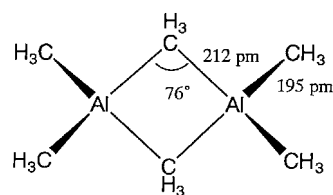
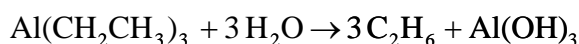

Fig. 5.2 Structure of trimethylaluminum.



Therefore, they should be handled in the laboratory under a perfectly inert atmosphere. The Ziegler-Natta catalyst, comprising an organoaluminium compound and a transition metal compound was an epoch-making olefin polymerization catalyst developed in the 1950s, for which the Nobel prize (1963) was awarded.

A transition-metal alkyl compound is formed when an organoaluminum compound reacts with a transition-metal compound. The transition-metal alkyl compound so formed can be isolated when stabilization ligands are coordinated to the metal center.

Gallium, Ga, has the largest temperature difference of the melting point and boiling point among all the metals. Since it melts slightly above a room temperature, the temperature range of the liquid state is very wide and it is used as a high temperature thermometer. In recent years, the metal is used for the manufacture of the compound semiconductors gallium arsenide, GaAs, and gallium phosphide, GaP.

Indium In is a soft metal also with a low melting-point. It is the raw material for compound semiconductors InP, InAs, *etc.* Indium has two stable states, In (I) or In (III), and In (II) compounds are considered to be **mixed-valence compounds** of monovalent and trivalent In.

Thallium Tl also has two stable states, Tl (I) and Tl (III), and Tl (II) is a mixed valence compound of monovalent and trivalent Tl. Since the element is very poisonous, the metal and its compounds should be handled carefully. As it is a weak reductant compared to $\text{Na}(\text{C}_5\text{H}_5)$, thallium cyclopentadienide, $\text{Tl}(\text{C}_5\text{H}_5)$, is sometimes used for the preparation of cyclopentadienyl compounds, and is a useful reagent in organometallic chemistry.

Exercise 5.3 Give the example of the metals for which stable ions differing in oxidation numbers exist.

[Answer] In(I), In(III), Tl(I), Tl(III), Sn(II), Sn(IV).

The reaction of organoaluminum compounds

Organoaluminum compounds were synthesized for the first time in 1859, but they were not regarded as important as Grignard reagents or organolithium compounds as synthetic reagents for some time. This is in part due to the low reactivity of the ether adducts, $R_3Al:OEt_2$, which were present because of the frequent use of ether as a solvent. The studies of K. Ziegler changed this situation. K. Ziegler also discovered oligomerization of ethylene by organoaluminum compounds and the formation of higher organoaluminum compounds by the insertion of ethylene in aluminum-carbon bonds. Since alcohols were formed by hydrolysis of organoaluminum compounds, these discoveries were important for organic synthesis.

The discovery of the action of trace amount of nickel in the reaction vessel to give only butene from ethylene led to investigation of the effect of transition metals upon this reaction. Many transition metal salts were examined and Ziegler discovered that titanium compounds gave the highest degree of polymerization of ethylene. This was the birth of the so-called Ziegler catalysts. It should be remembered that this great discovery of the 1950s occurred when the petrochemical industry was beginning to develop and revolutionized the chemical industry of higher polymers.

5.5 Group 14 metals

Of the ten isotopes of tin, Sn, ^{118}Sn (24.22%) and ^{120}Sn (33.59%) are the most abundant. Metallic tin is present as α tin (gray tin), which is stable below 13.2 °C and β tin which is stable at higher temperatures. At low temperatures, the phase transition is quick. Divalent and tetravalent compounds are common, and divalent compounds are reducing agents.

^{208}Pb (52.4%) is the most abundant among the four stable isotopes of lead, Pb. Lead is the end product of natural radioactive decay and has 82 protons. The atomic number 82 is important as it is especially stable. Thus, Pb exhibits high abundance for a heavy element. The divalent and tetravalent oxidation states are most common and usually lead is present as Pb^{2+} except in organometallic compounds. PbO_2 is a tetravalent compound and readily becomes divalent, hence it is a very strong oxidizing agent. Although tetraethyl lead was previously used as an anti-knock agent in gasoline, only unleaded gasoline is now permitted for use in Japan.

It has been known since the 1930s that when Ge, Sn, or Pb are reduced by sodium in liquid ammonia, multi nuclear anions such as Ge_9^{4-} , Sn_5^{2-} , and Pb_9^{4-} , are formed. These

are called Zintl phases. These multi-atom anions were crystallized as $[\text{Na}(\text{crypt})]_4 [\text{Sn}_9]$ *etc.* recently using a cryptand, and cluster structures have been elucidated.

Problem

5.1 Write a balanced equation for the formation of butyllithium.

5.2 Potassium permanganate is insoluble in benzene but it dissolves in this solvent in the presence of a crown ether which is a cyclic polyether. Why is the solubility of potassium permanganate increased in the presence of a crown ether?

5.3 Why is trimethylaluminum called an electron deficient compound?

6 Chemistry of Transition Metals

Simple substances of transition metals have properties characteristic of metals, *i.e.* they are hard, good conductors of heat and electricity, and melt and evaporate at high temperatures. Although they are used widely as simple substances and alloys, we typically encounter only iron, nickel, copper, silver, gold, platinum, or titanium in everyday life. However, molecular complexes, organometallic compounds, and solid-state compounds such as oxides, sulfides, and halides of transition metals are used in the most active research areas in modern inorganic chemistry.

Transition elements are metallic elements that have incomplete d or f shells in the neutral or cationic states. They are called also transition metals and make up 56 of the 103 elements. These transition metals are classified into the d -block metals, which consist of $3d$ elements from Sc to Cu, $4d$ elements from Y to Ag, and $5d$ elements from Hf to Au, and f -block metals, which consist of lanthanoid elements from La to Lu and actinoid elements from Ac to Lr. Although Sc and Y belong to the d -block, their properties are similar to those of lanthanoids. The chemistry of d -block and f -block elements differs considerably. This chapter describes the properties and chemistry of mainly d -block transition metals.

6.1 Structures of metal complexes

(a) Central metals

Properties of d -block transition metals differ considerably between the first ($3d$) and the second series metals ($4d$), although the differences in properties between the second and the third series ($5d$) metals is not pronounced. Metallic radii of elements from scandium, Sc, to copper, Cu, (166 to 128 pm) are significantly smaller than those of yttrium, Y, to silver, Ag, (178 to 144 pm) or those of lanthanum, La, to gold, Au, (188 to 146 pm). Further, metal compounds of the first series transition metals are rarely 7 co-ordinate, whereas transition metals from the second and third series may be 7 to 9 coordinate. Cerium, Ce, (radius 182 pm) ~ lutetium, Lu, (radius 175 pm) fall between La and Hf and, because of the lanthanide contraction, metallic radii of the second and third series transition metals show little variation.

Higher oxidation states in the second and third series transition metals are

considerably more stable than those in the first series transition metals. Examples include tungsten hexachloride, WCl_6 , osmium tetroxide, OsO_4 , and platinum hexafluoride, PtF_6 . Compounds of the first series transition metals in higher oxidation states are strong oxidants and thus are readily reduced. On the other hand, whereas M(II) and M(III) compounds are common among the first series transition metals, these oxidation states are generally uncommon in compounds of second and third series metals. For example, there are relatively few Mo(III) or W(III) compounds compared with many Cr(III) ones. Aqua ions (ions with water ligands) are very common among compounds of first series metals but few are known amongst the second and third metal compounds.

Metal carbonyl cluster compounds of first series transition metals with M-M bonds in low oxidation states exist but halide or sulfide cluster compounds are rare. In general, metal-metal bonds are formed much more easily in the $4d$ and $5d$ metals than in the $3d$ ones. Magnetic moments of the first series transition metal compounds can be explained in terms of spin-only values (*cf.* Chapter 6.2 (d)) but it is difficult to account for the magnetic moments of the second and third series compounds unless complex factors such as spin-orbital interactions are taken into account.

Thus, it is necessary to acknowledge and understand the significant differences in chemical properties that exist between metals of the first and later series metal compounds, even for elements in the same group.

Properties of the d -block transition metals are different not only in the upper and lower positions in the periodic table but also in the left and right groups. The Group 3 to 5 metals are now often referred to as **early transition metals** and they are generally oxophilic and halophilic. Smaller numbers of d electrons and the hardness of these elements explain their affinity toward hard oxygen and halogens. In the absence of bridging ligands, the formation of metal-metal bonds is difficult for these elements. Organometallic compounds of these metals are known strongly to activate C-H bonds in hydrocarbons. **Late transition metals** in the groups to the right of the periodic table are soft and have a high affinity toward sulfur or selenium.

The d -block transition metals have s , p , and d orbitals and those with n electrons in the d orbitals are termed **ions with a d^n configuration**. For example, Ti^{3+} is a d^1 ion, and Co^{3+} a d^6 ion. The number of electrons occupying the orbitals split by the ligand field (*cf.* 6.2(a)) is denoted by a superscript on the orbital symbol. For example, an ion with 3 electrons in t_{2g} and 2 electrons in e_g is described as $t_{2g}^3 e_g^2$.

(b) Ligands

Compounds of metal ions coordinated by ligands are referred to as **metal complexes**. Most ligands are neutral or anionic substances but cationic ones, such as the

tropylium cation, are also known. Neutral ligands, such as ammonia, NH_3 , or carbon monoxide, CO , are independently stable molecules in their free states, whereas anionic ligands, such as Cl^- or C_5H_5^- , are stabilized only when they are coordinated to central metals. Representative ligands are listed in Table 6.1 according to the ligating elements. Common ligands or those with complicated chemical formula are expressed in abbreviated forms.

Those ligands with a single ligating atom are called **monodentate ligands**, and those with more than one ligating atoms referred to as **polydentate ligands**, which are also called **chelate ligands**. The number of atoms bonded to a central metal is the **coordination number**.

Table 6.1 Representative ligands

Name	Abbreviation	Formula
hydrido		H^-
carbonyl		CO
cyano		CN^-
methyl	Me	CH_3^-
cyclopentadienyl	Cp	C_5H_5^-
carbonato		CO_3^{2-}
ammine		NH_3
pyridine	py	$\text{C}_5\text{H}_5\text{N}$
bipyridine	bipy	$\text{C}_{10}\text{H}_8\text{N}_2$
triphenylphosphine	PPh_3	$\text{P}(\text{C}_6\text{H}_5)_3$
aqua	aq	H_2O
acetylacetonato	acac	$\text{CH}_3\text{C}(\text{O})\text{CH}_2\text{C}(\text{O})\text{CH}_3^-$
thiocyanato		SCN^-
chloro		Cl^-
ethylenediaminetetraacetato	edta	$(\text{OOCCH}_2)_2\text{NCH}_2\text{CH}_2\text{N}(\text{CH}_2\text{COO})_2^{4-}$

(c) Coordination number and structures

Molecular compounds which consist of *d*-block transition metals and ligands are referred to as complexes or **coordination compounds**. The coordination number is determined by the size of the central metal, the number of *d* electrons, or steric effects arising from the ligands. Complexes with coordination numbers between 2 and 9 are known. In particular 4 to 6 coordination are the most stable electronically and

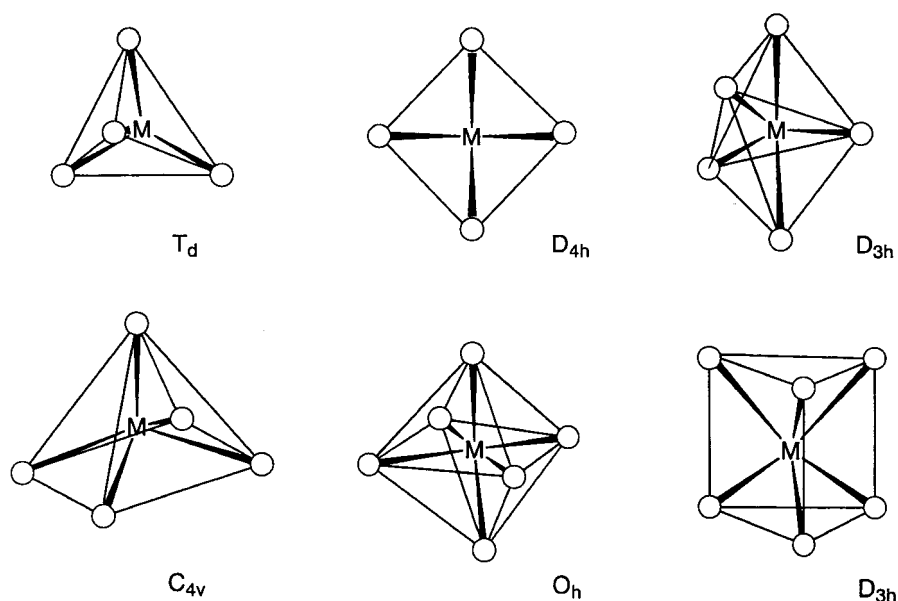

Fig. 6.1 Structure of 4 ~ 6 coordination.

geometrically and complexes with these coordination numbers are the most numerous (Fig. 6.1). Complexes with the respective coordination numbers are described below.

Two co-ordinate complexes

Many electron-rich d^{10} ions, viz: Cu^+ , Ag^+ , and Au^+ , form linear complexes such as $[Cl-Ag-Cl]^-$ or $[H_3N-Au-NH_3]$. A zero-valent complex $[Pd(PCy_3)_2]$ with very bulky tricyclohexylphosphine ligands is also known. Generally, stable 2-coordinate complexes are known for the late transition metals.

Three co-ordinate complexes

Although $[Fe\{N(SiMe_3)_3\}_3]$ is one example, very few 3-coordinate complexes are known.

Four co-ordinate complexes

When four ligands coordinate to a metal, tetrahedral (T_d) coordination is the least congested geometry, although a number of square planar (D_{4h}) complexes are known. $[CoBr_4]^{2-}$, $Ni(CO)_4$, $[Cu(py)_4]^+$, $[AuCl_4]^-$ are all examples of tetrahedral complexes. There are a few known examples of square planar complexes with identical ligands, such as $[Ni(CN)_4]^{2-}$, or $[PdCl_4]^{2-}$. In the case of **mixed ligand complexes**, a number of square planar complexes of d^8 ions, Rh^+ , Ir^+ , Pd^{2+} , Pt^{2+} , and Au^{3+} , have been reported. Examples include $[RhCl(PMe_3)_3]$, $[IrCl(CO)(PMe_3)_2]$, $[NiCl_2(PEt_3)_2]$, and $[PtCl_2(NH_3)_2]$ (Et = C_2H_5).

Cis and trans **geometrical isomers** are possible for complexes with two different kinds of ligands, and were first noted when A. Werner synthesized 4-coordinate $[\text{PtCl}_2(\text{NH}_3)_2]$. As tetrahedral complexes do not give geometrical isomers, Werner was able to conclude that his 4-coordinate complexes were square planar. Recently *cis*- $[\text{PtCl}_2(\text{NH}_3)_2]$ (Cisplatin) has been used for the treatment of tumors and it is noteworthy that only the *cis* isomer is active.

Exercise 6.1 Write the formal name of *cis*- $[\text{PtCl}_2(\text{NH}_3)_2]$.

[Answer] *cis*-diamminedichloroplatinum.

Five co-ordinate complexes

Trigonal bipyramidal (D_{3h}) $\text{Fe}(\text{CO})_5$ or square pyramid (C_{4v}) $\text{VO}(\text{OH}_2)_4$ are examples of 5-coordinate complexes. Previously, 5-coordinate complexes were rare but the number of new complexes with this coordination is increasing. The energy difference between the two coordination modes is not large and structural transformation readily occurs. For example, the molecular structure and infrared spectrum of $\text{Fe}(\text{CO})_5$ are consistent with a trigonal bipyramid structure, but the ^{13}C NMR spectrum shows only one signal at the possible lowest temperature, which indicates that the axial and equatorial carbonyl ligands are fluxional in the NMR time scale ($10^{-1}\sim 10^{-9}$ s). Structural transformation takes place via a square pyramid structure and the mechanism is well known as **Berry's pseudorotation**.

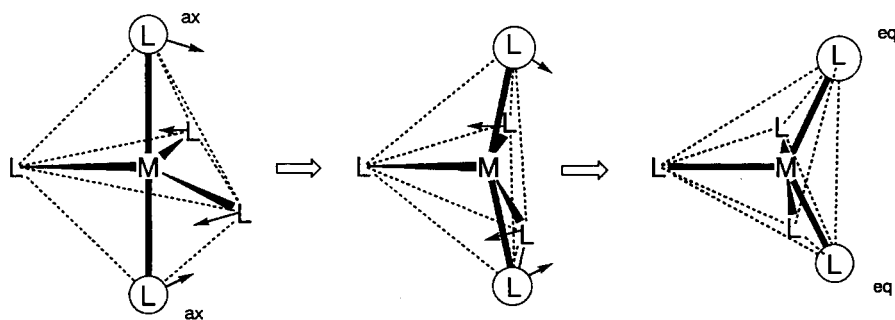

Fig. 6.2 Berry's pseudorotation.

Six co-ordinate complexes

When six ligands coordinate to a central metal, octahedral (O_h) coordination is the most stable geometry and the majority of such complexes assume this structure. In particular, there are a number of Cr^{3+} and Co^{3+} complexes which are inert to ligand exchange reactions, represented by $[\text{Cr}(\text{NH}_3)_6]^{3+}$ or $[\text{Co}(\text{NH}_3)_6]^{3+}$. They have been particularly important in the history of the development of coordination chemistry. $[\text{Mo}(\text{CO})_6]$, $[\text{RhCl}_6]^{3-}$, etc. are also octahedral complexes. In the case of mixed ligands, *cis*- and *trans*- $[\text{MA}_4\text{B}_2]$ and *mer*- and *fac*- $[\text{MA}_3\text{B}_3]$ geometrical isomers, and for chelate ligands, Δ - $[\text{M}(\text{A-A})_3]$ and Λ - $[\text{M}(\text{A-A})_3]$ **optical isomers** (Fig. 6.3) are possible. The octahedral structure shows tetragonal (D_{4h}), rhombic (D_{2h}), or trigonal (D_{3h}) distortions caused by electronic or steric effects. The tetragonal distortion of $[\text{Cu}(\text{NH}_3)_6]^{2+}$ by an electronic factor is a typical example of the Jahn-Teller effect (refer to 6.2(a)).

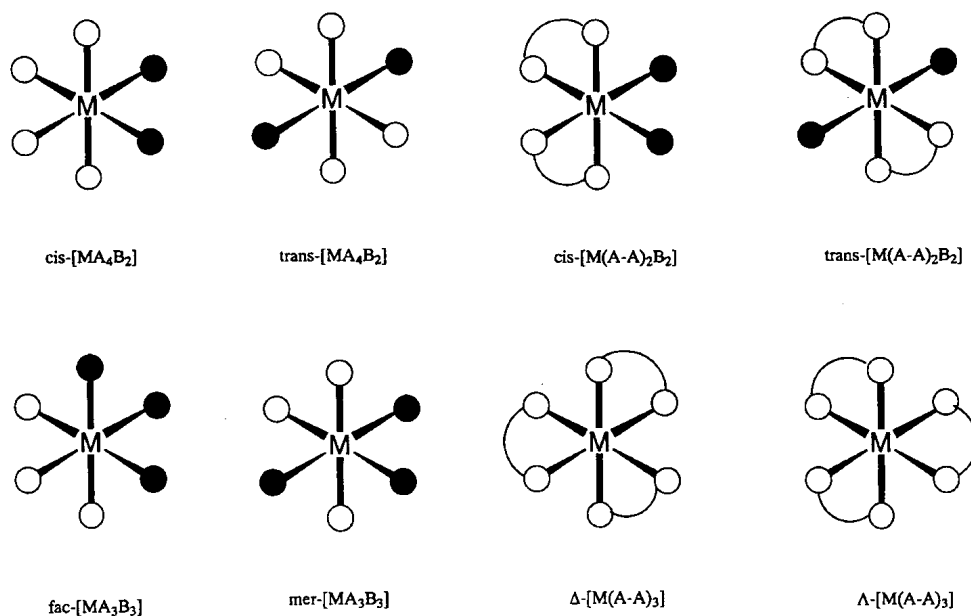

Fig. 6.3 Geometrical isomers of 6-coordination.

Six ligating atoms can assume trigonal prism coordination. Although this coordination is seen in $[\text{Zr}(\text{CH}_3)_6]^{2-}$ or $[\text{Re}\{\text{S}_2\text{C}_2(\text{CF}_3)_2\}_3]$, few metal complexes with this coordination structure are known because octahedral coordination is sterically less strained. This notwithstanding, it has long been known that the bonding mode of sulfur atoms around a metal is trigonal prism in solid-state MoS_2 and WS_2 .

Exercise 6.2 Write the chemical formula of potassium diamminetetra(isothiocyanato)chromate(III).

[Answer] $\text{K}[\text{Cr}(\text{NCS})_4(\text{NH}_3)_2]$.

Higher co-ordinate complexes

Metal ions of the second and third transition metal series can sometimes bond with more than seven ligating atoms and examples are $[\text{Mo}(\text{CN})_8]^{3-}$ or $[\text{ReH}_9]^{2-}$. In these cases, smaller ligands are favorable to reduce steric congestion.

6.2 Electronic structure of complexes

It is necessary to learn a few concepts to understand the structure, spectrum, magnetism, and reactivity of complexes which depend on d electron configurations. In particular, the theory of electronic structure is important.

(a) Ligand field theory

Ligand field theory is one of the most useful theories to account for the electronic structure of complexes. It originated in the application of the **crystal field theory** of ionic crystals to metal complex systems.

Six co-ordinate octahedral complexes

The five d orbitals of transition metal cations are degenerate and have equal energy.

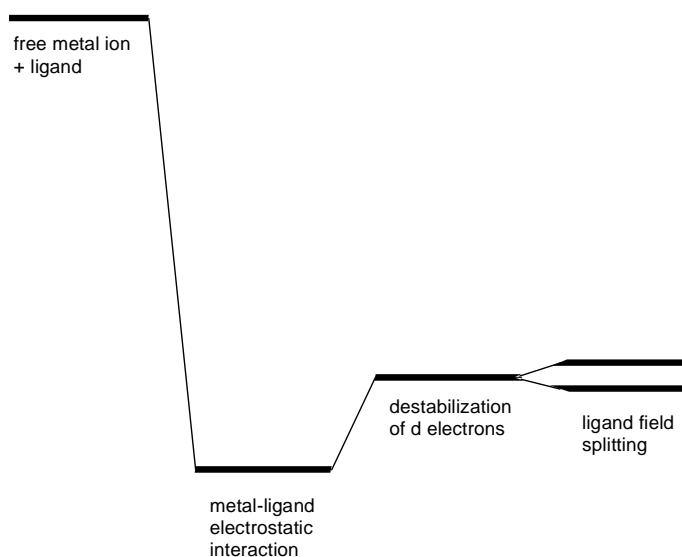

Fig. 6.4 Change of electronic energy upon complex formation.

The spherical negative electric field around a metal cation results in the total energy level being lower than that of a free cation because of the electrostatic interactions. The repulsive interaction between the electrons in the metal orbitals and the negative electric field destabilizes the system and compensates for the stabilization to some extent (Fig. 6.4).

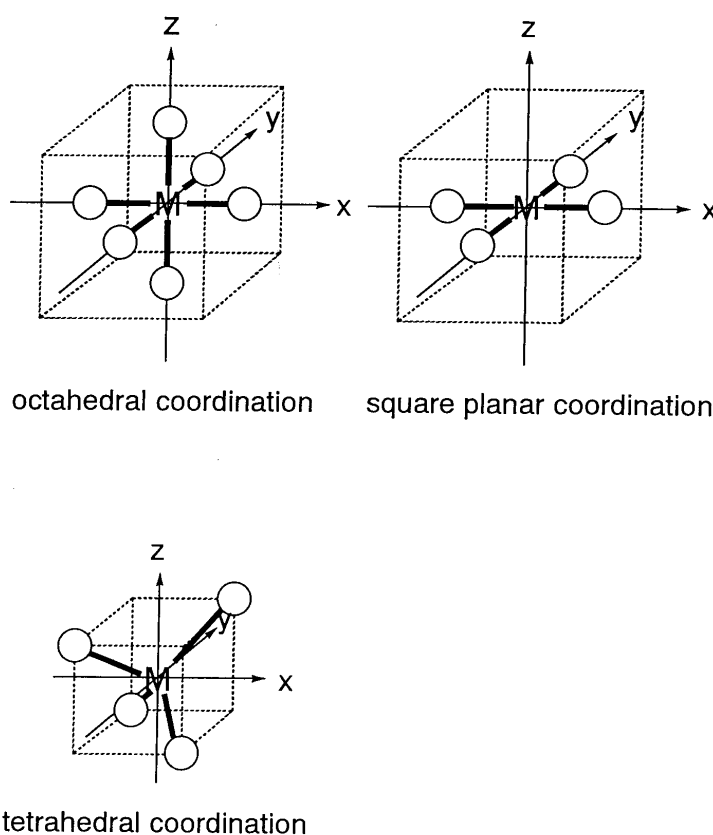

Fig. 6.5 Ligand positions in the Cartesian coordinate with a metal ion at the origin.

Let us assume that instead of a uniform spherical negative field, the field is generated by six ligands coordinating octahedrally to a central metal. The negative field of the ligands is called the **ligand field**. Negative charge, in the case of anionic ligands, or a negative end (lone pair), in the case of neutral ligands, exert a repulsive force on the metal d orbitals which is anisotropic depending on the direction of the orbitals. The position of the metal cation is taken as the origin and Cartesian coordinates are constructed (Fig. 6.5). Then, $d_{x^2-y^2}$ and d_{z^2} orbitals are aligned along the directions of the axes and the d_{xy} , d_{yz} , and d_{xz} orbitals are directed between the axes. If ligands are placed on the axes, the repulsive interaction is larger for the e_g orbitals ($d_{x^2-y^2}$, d_{z^2}) than for the t_{2g}

orbitals (d_{xy} , d_{yz} , d_{xz}), and the e_g orbitals are destabilized and the t_{2g} orbitals are stabilized to an equal extent. In the following discussion, only the energy difference between the t_{2g} and e_g orbitals is essential and the average energy of these orbitals is taken as the zero of energy. If the energy difference between the two e_g and three t_{2g} orbitals is set to Δ_o , the energy level of the e_g orbitals is $+3/5\Delta_o$ and that of the t_{2g} orbitals is $-2/5\Delta_o$ (Fig. 6.6). (Δ_o may also be expressed as $10 Dq$. In this case, the energy level of the e_g orbitals is $+6 Dq$ and that of the t_{2g} orbitals $-4 Dq$.)

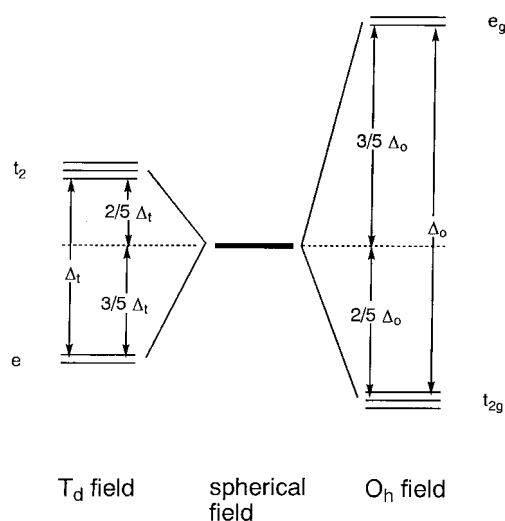

Fig. 6.6 Ligand field splitting in tetrahedral and octahedral complexes.

Transition metal ions have 0 to 10 d electrons and when the split d orbitals are filled from a lower energy level, the electron configuration $t_{2g}^x e_g^y$ corresponding to each ion is obtained. With the zero energy level chosen as the average energy level, the energy of the electron configuration relative to zero energy becomes

$$\text{LFSE} = (-0.4x + 0.6y) \Delta_o$$

This value is called the **ligand field stabilization energy**. The electron configuration with smaller value (taking the minus sign into consideration) is more stable. LFSE is an important parameter to explain some properties of d -block transition metal complexes.

A condition other than the orbital energy level is required to explain the filling of electrons being populated into the split t_{2g} and e_g orbitals. Two electrons can occupy an orbital with anti-parallel spins but a strong electrostatic repulsion occurs between two electrons in the same orbital. This repulsive interaction is called **pairing energy**, P .

When the number of d electrons is less than three, the pairing energy is minimized by loading the electrons in the t_{2g} orbital with parallel spins. Namely, the electron configurations arising are t_{2g}^1 , t_{2g}^2 , or t_{2g}^3 .

Two possibilities arise when the fourth electron occupies either of the t_{2g} or e_g orbitals. The lower energy orbital t_{2g} is favorable but occupation of the same orbital gives rise to pairing energy, P . The total energy becomes

$$-0.4\Delta_o \times 4 + P = -1.6\Delta_o + P$$

If the fourth electron occupies the energetically unfavorable e_g orbital, the total energy becomes

$$-0.4\Delta_o \times 3 + 0.6\Delta_o = -0.6\Delta_o$$

The choice of the electron configuration depends on which of the above values is larger. Therefore if $\Delta_o > P$, t_{2g}^4 is favoured and this is called the strong field case or the **low spin electron configuration**. If $\Delta_o < P$, $t_{2g}^3e_g^1$ is favoured and this is called the weak field case or the **high spin electron configuration**. A similar choice is required for d^5 , d^6 , and d^7 octahedral complexes, and in the strong field case, t_{2g}^5 , t_{2g}^6 , or $t_{2g}^6e_g^1$ configurations are favoured, whereas in the weak field case, $t_{2g}^3e_g^2$, $t_{2g}^4e_g^2$, or $t_{2g}^5e_g^2$ configurations are favoured. The ligand field splitting parameter Δ_o is decided by the nature of the ligands and metal, whereas the pairing energy, P , is almost constant and shows only a slight dependence on the identity of the metal.

Square planar complexes

Complexes with four ligands in a plane containing the central metal are termed square planar complexes. It is easier to understand the electronic energy levels of the d orbitals in square planar complexes by starting from those for hexacoordinate octahedral complexes. Placing the six ligands along the Cartesian axes, the two ligands on the z axis are gradually removed from the central metal and finally only four ligands are left on the x,y plane. The interaction of the two z coordinate ligands with the d_{z^2} , d_{xz} , and d_{yz} orbitals becomes smaller and the energy levels of these ligands lower. On the other hand, the remaining four ligands approach the metal and the $d_{x^2-y^2}$ and d_{xy} energy levels rise as a result of the removal of the two ligands. This results in the order of the energy levels of five d orbitals being $d_{xz}, d_{yz} < d_{z^2} < d_{xy} \ll d_{x^2-y^2}$ (Fig. 6.7). Rh^+ , Ir^+ , Pd^{2+} , Pt^{2+} , and Au^{3+} complexes with a d^8 configuration tend to form square planar structures because eight electrons occupy the lower orbitals leaving the highest $d_{x^2-y^2}$ orbital empty.

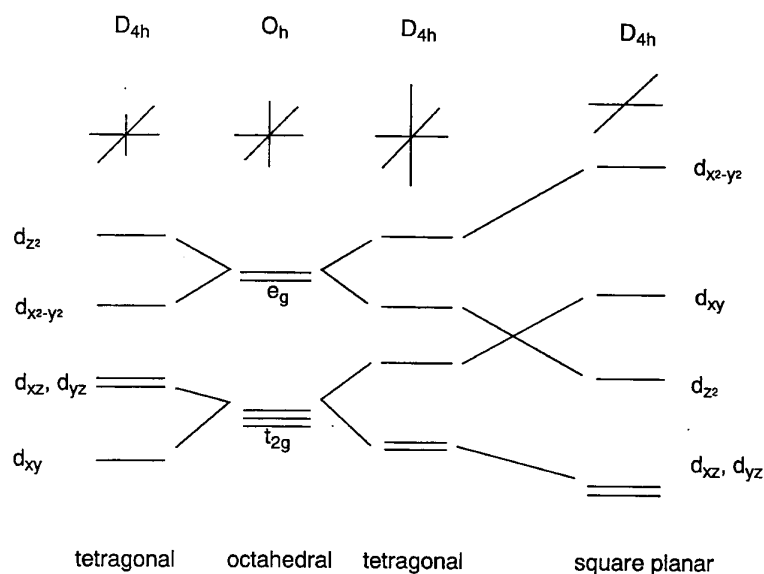

Fig. 6.7 Change of the orbital energy from octahedral to square planar complexes.

Tetrahedral complexes

Tetrahedral complexes have four ligands on the apexes of a tetrahedron around the central metal. $[\text{CoX}_4]^{2-}$ ($X = \text{Cl}, \text{Br}, \text{I}$), $\text{Ni}(\text{CO})_4$, etc. are all examples of 4-coordination complexes (Fig. 6.5). When a metal is placed on the origin of the Cartesian axes, as in the octahedral complexes, e orbitals ($d_{x^2-y^2}$, d_{z^2}) are distant from ligands and t_2 orbitals (d_{xy} , d_{yz} , d_{xz}) are nearer ligands. Consequently, the electronic repulsion is larger for the t_2 orbitals, which are destabilized relative to the e orbitals. The ligand field exerted by four ligands splits the fivefold degenerate orbitals of the central metal into twofold degenerate e and threefold degenerate t_2 sets (Fig. 6.6). The t_2 set has energy of $+2/5 \Delta_t$ and the e set $-3/5 \Delta_t$ with a ligand field splitting of Δ_t . As the number of the ligands is $4/6 = 2/3$ of that in hexacoordinate octahedral complexes, and overlap of the ligands with the orbitals is smaller, and the ligand splitting Δ_t is about a half of Δ_o . Consequently, only high-spin electron configurations are known in tetrahedral complexes. The ligand field splitting energies calculated by the above method are shown in Table 6.2.

Table 6.2 Ligand field stabilization energy (LFSE)

d ⁿ	Example	Octahedral		Tetrahedral			
		Strong field (LS)	Weak field(HS)	n	Δ_o	n	Δ_t
d ¹	Ti ³⁺	1	0.4	1	0.4	1	0.6
d ²	V ³⁺	2	0.8	2	0.8	2	1.2
d ³	Cr ³⁺ , V ²⁺	3	1.2	3	1.2	3	0.8
d ⁴	Cr ²⁺ , Mn ³⁺	2	1.6	4	0.6	4	0.4
d ⁵	Mn ²⁺ , Fe ³⁺	1	2.0	5	0	5	0
d ⁶	Fe ²⁺ , Co ³⁺	0	2.4	4	0.4	4	0.6
d ⁷	Co ²⁺	1	1.8	3	0.8	3	1.2
d ⁸	Ni ²⁺	2	1.2	2	1.2	2	0.8
d ⁹	Cu ²⁺	1	0.6	1	0.6	1	0.4
d ¹⁰	Cu ¹	0	0	0	0	0	0

Jahn-Teller effect

When orbitals of a highly symmetrical nonlinear polyatomic molecule are degenerate, the degeneracy is resolved by distorting the molecular framework to attain lower symmetry and thus lower energy. This is the **Jahn-Teller effect** and a typical example is seen in the tetragonal distortion of an octahedral coordination structure of hexacoordinate Cu²⁺ complexes.

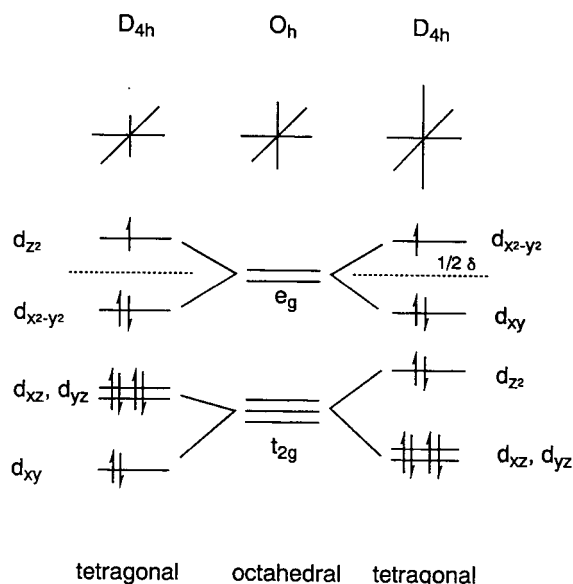
**Fig. 6.8** Jahn-Teller splitting in a Cu²⁺ ion.

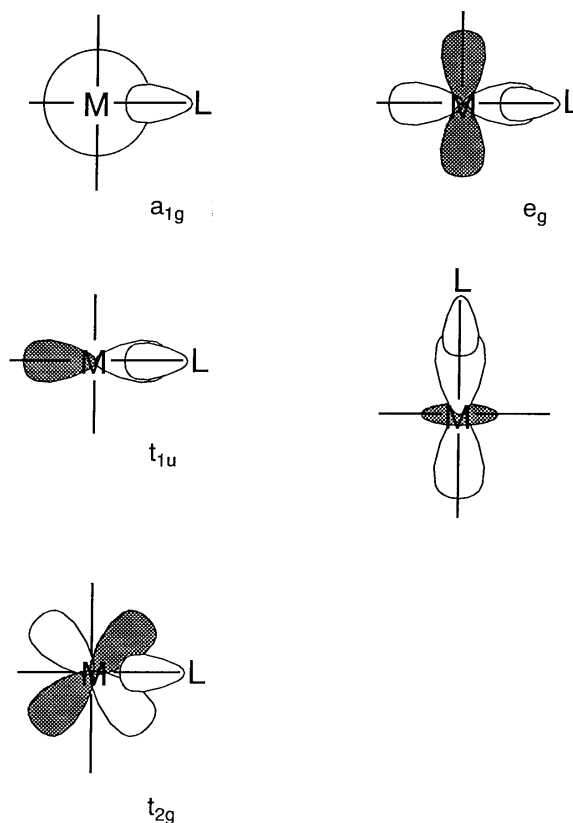

Fig. 6.9 The relation between the metal and ligand orbitals during formation of σ bonds.

They have a d^9 configurations and the e_g orbitals in the octahedral structure are occupied by three electrons. If the e_g orbitals split and two electrons occupy the lower orbital and one electron the upper orbital, the system gains energy of a half of the energy difference, δ , of two split orbitals. Therefore a tetragonal distortion in the z axis becomes favorable.

Molecular orbital theory of transition metal complexes

The characteristics of transition metal-ligand bonds become clear by an analysis of the molecular orbitals of a $3d$ metal coordinated by six identical ligands in octahedral complexes $[ML_6]$. As the result of the interaction between the metal d and ligand orbitals, bonding, non-bonding and anti-bonding complex molecular orbitals are formed.

Generally, the energy levels of the ligand orbitals are lower than those of the metal orbitals, bonding orbitals have more ligand character and non-bonding and anti-bonding orbitals have more metal character. The processes of formation of the σ and π molecular orbitals are described step by step below.

σ bond

Firstly, consider the M-L σ bond among interactions of the metal s , p , d and ligand orbitals by assuming the position of a metal at the origin of the Cartesian coordinate system and locating ligands on the coordinate axes. As the σ bond is a nodeless bond along the bonding axes, the metal s orbital (a_{1g} , non-degenerate), p_x , p_y , p_z orbitals (t_{1u} , triply-degenerate), and $d_{x^2-y^2}$, d_{z^2} orbitals (e_g , doubly-degenerate) fit symmetry (+, - signs) and orbital shapes with the ligands' σ orbitals (Fig. 6.9).

When the ligand orbitals are σ_1 and σ_2 along the x-axis, σ_3 and σ_4 along the y-axis, and σ_5 and σ_6 along the z-axis in Fig. 6.5, six ligand atomic orbitals are grouped by making linear combinations according to the symmetry of the metal orbitals. Then the orbital to fit with the metal a_{1g} orbital is a_{1g} ($\sigma_1+\sigma_2+\sigma_3+\sigma_4+\sigma_5+\sigma_6$), the one to fit with the metal t_{1u} orbitals is t_{1u} ($\sigma_1-\sigma_2, \sigma_3-\sigma_4, \sigma_5-\sigma_6$) and the one to fit with the metal e_g orbitals is e_g ($\sigma_1+\sigma_2-\sigma_3-\sigma_4, 2\sigma_5+2\sigma_6-\sigma_1-\sigma_2-\sigma_3-\sigma_4$). There is a bonding interaction between the metal e_g orbitals and the ligand group orbitals and bonding and anti-bonding molecular orbitals are formed. The relation is shown in Fig. 6.10.

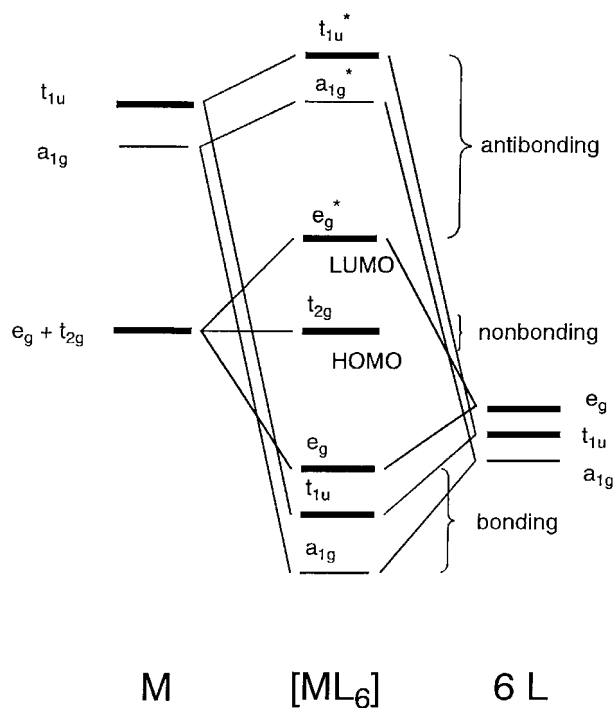

Fig. 6.10 Bonding and anti-bonding M(metal)-L(ligand) molecular orbitals.

The levels of the molecular orbitals from the lowest energy are bonding ($a_{1g} < t_{1u} < e_g$) < non-bonding (t_{2g}) < anti-bonding ($e_g^* < a_{1g}^* < t_{1u}^*$). For example, in a complex like $[\text{Co}(\text{NH}_3)_6]^{3+}$, 18 valence electrons, 6 from cobalt and 12 from ammonia, occupy 9

orbitals from the bottom up, and t_{2g} is the HOMO and e_g^* the LUMO. The energy difference between the two levels corresponds to the ligand field splitting. Namely, the e_g set ($d_{x^2-y^2}, d_{z^2}$) and the ligands on the corner of the octahedron form the bonding σ orbitals but the t_{2g} set (d_{xy}, d_{yz}, d_{xz}) remain non-bonding because the orbitals are not directed to the ligand σ orbitals.

π bond

When the ligand atomic orbitals have π symmetry (i.e. with nodes) through the bond axis, the e_g orbitals ($d_{x^2-y^2}$) are non-bonding and the t_{2g} orbitals (d_{xy}, d_{yz}, d_{xz}) have bonding interactions with them (Fig. 6.11). In halide ions, X^- , or aqua ligands, H_2O , the π

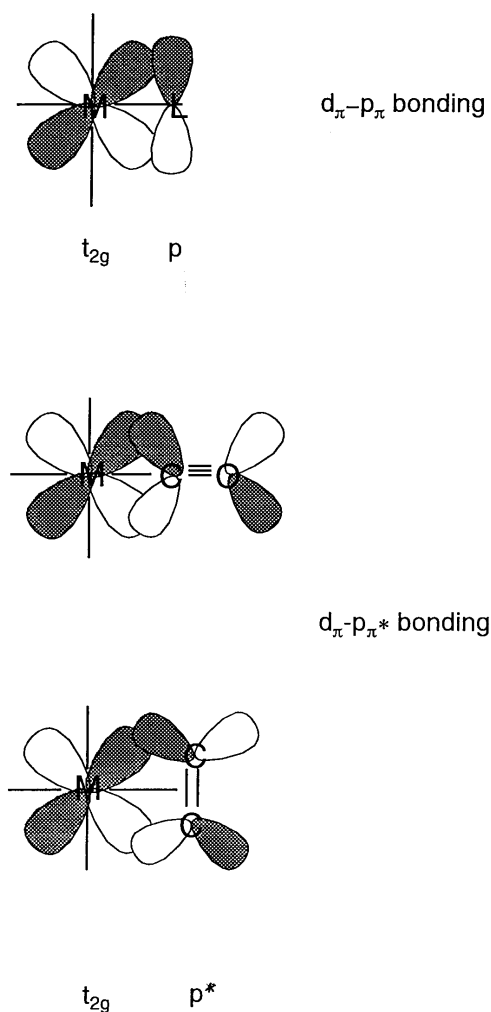

Fig. 6.11 The relation between the metal and ligand orbitals in formation of a π bond.

symmetrical p orbitals have lower energy than the metal t_{2g} orbitals and a bonding molecular orbital, which is lower than the t_{2g} orbital, and an anti-bonding molecular

orbital, which is higher than the t_{2g} orbitals, form. Consequently, the energy difference Δ_o between e_g and the anti-bonding orbitals becomes smaller. On the other hand, for the ligands having anti-bonding π orbitals within the molecule, such as carbon monoxide or ethylene, the π^* orbitals match the shape and symmetry of the t_{2g} orbitals and the molecular orbitals shown in Fig 6.12 (b) form. As a result, the energy level of the bonding orbitals decreases and Δ_o becomes larger.

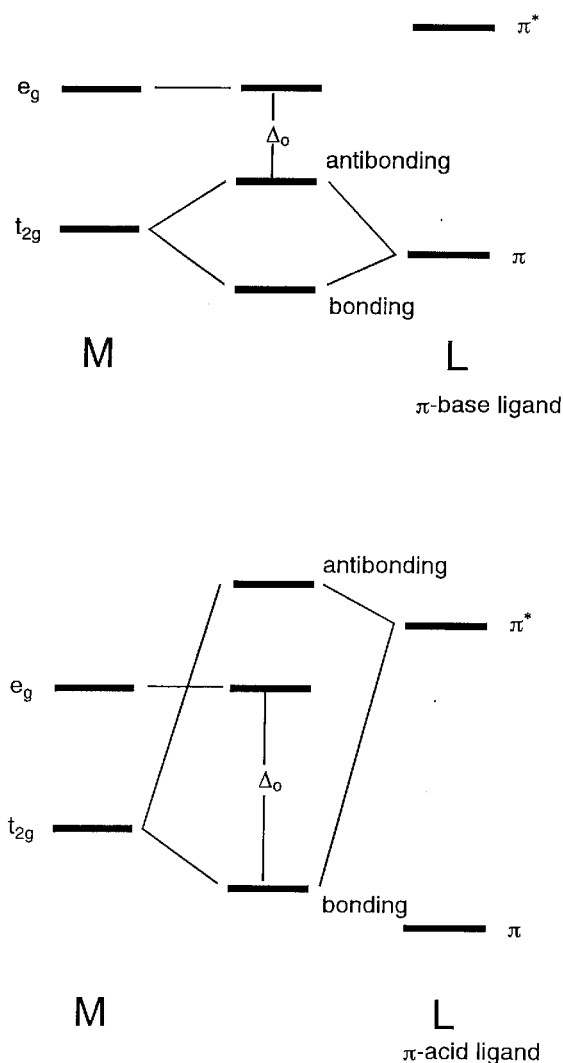

Fig. 6.12 The energy change upon formation of $M-L_{\pi}$ bonds.

Using these simple molecular orbital considerations, the effects of σ and π orbital interactions between the metal and ligands upon the molecular orbitals are qualitatively understandable.

(c) Spectra

Many transition metal complexes have characteristic colors. This means that there is absorption in the visible part of the spectrum resulting from an electron being excited by visible light from a level occupied by an electron in a molecular orbital of the complex to an empty level. If the energy difference between the orbitals capable of transition is set to ΔE , the absorption frequency ν is given by $\Delta E = h \nu$. Electronic transitions by optical pumping are broadly classified into two groups. When both of the molecular orbitals between which a transition is possible have mainly metal d character, the transition is called a ***d-d* transition** or **ligand-field transition**, and absorption wavelength depends strongly on the ligand-field splitting. When one of the two orbitals has mainly metal character and the other has a large degree of ligand character, the transition is called a **charge-transfer transition**. Charge transfer transitions are classified into metal (M) to ligand (L) charge-transfers (MLCT) and ligand to metal charge-transfers (LMCT).

Since the analysis of the spectra of octahedral complexes is comparatively easy, they have been studied in detail for many years. When a complex has only one d electron, the analysis is simple. For example, Ti in $[\text{Ti}(\text{OH}_2)_6]^{3+}$ is a d^1 ion, and an electron occupies the t_{2g} orbital produced by the octahedral ligand field splitting. The complex is purple as the result of having an absorption at 492 nm (20300 cm^{-1}) (Fig. 6.13) corresponding to the optical pumping of a d electron to the e_g orbital. However, in a complex with more than one d electrons, there are repellent interactions between the electrons, and the $d-d$ transition spectrum has more than one absorptions. For example, a d^3 complex $[\text{Cr}(\text{NH}_3)_6]^{3+}$ shows two $d-d$ absorptions in the 400 nm (25000 cm^{-1}) region, suggesting that the complex has two groups of molecular orbitals between which an electronic transition is possible with a high degree of transition probability. This means that, when three electrons in the t_{2g} orbital are excited to the e_g orbital, there are two energy differences due to repellent interactions between the electrons.

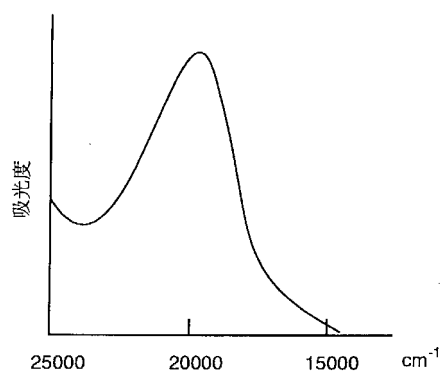
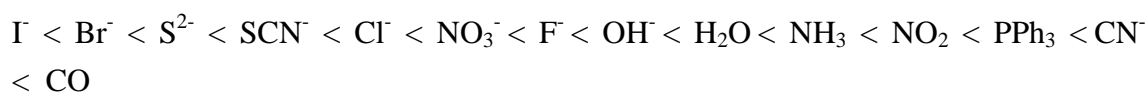

Fig. 6.13 A visible absorption spectrum of $[\text{Ti}(\text{OH}_2)_6]^{3+}$.

Tanabe-Sugano diagrams are constructed from calculations based on ligand field theory and have been widely used in the analysis of absorption spectra of d^1 to d^9 ions. The analysis becomes increasingly difficult for ions with many electrons. In any case, the existence of a $d-d$ spectrum requires that the energy difference of an occupied orbital and an empty orbital is equivalent to the energy of the UV-visible spectrum, the transition is allowed by the selection rule, and the transition probability is high enough. Generally, a charge-transfer absorption is stronger than a ligand field absorption. An LMCT emerges when ligands have a non-bonding electron pair of comparatively high energy or the metal has empty low energy orbitals. On the other hand, an MLCT tends to appear when the ligands have low energy π^* orbitals, and bipyridine complexes are good examples of this. Since the lifetime of the excited state of a ruthenium complex $[\text{Ru}(\text{bipy})_3]^{2+}$ is extraordinarily long, many studies have been performed on its photoredox reactions.

Spectrochemical series

The magnitude of the ligand field splitting parameter Δ_0 is determined mainly by the identity of the ligands. An empirical rule called the **spectrochemical series** was proposed by a Japanese scientist Ryutarō Tsuchida. The rule was constructed from empirical data collected when spectra of complexes that have the same central metal, oxidation state, coordination number, *etc.* were measured. It is noteworthy that ligands with π acceptor properties are in a higher position in the series.



Although Δ_0 does become larger in this order, it is also dependent on the identity of the central metal and its oxidation state. Namely, Δ_0 is larger for $4d$ and $5d$ metals than for $3d$ metals and becomes larger as the oxidation number increases. The magnitude of Δ_0 is closely related to its absorption position in the electromagnetic spectrum, and is a key factor in determining the position of a ligand in the spectrochemical series. A π donor ligand (halogen, aqua, *etc.*) makes the absorption wavelength longer, and a π acceptor ligand (carbonyl, olefin, *etc.*) shorter by contribution from the π bond.

(d) Magnetism

Magnetization, M , (magnetic dipole moment per unit volume) of a sample in a magnetic field, H , is proportional to magnitude of H , and the proportionality constant, χ , depends on the sample.

$$M = \chi H$$

χ is the **volume susceptibility** and the product of χ and the molar volume V_m of a sample is the **molar susceptibility** χ_m . Namely,

$$\chi_m = \chi V_m$$

All substances have diamagnetism, and in addition to this, substances with unpaired electrons exhibit paramagnetism, the magnitude of which is about 100 times larger than that of diamagnetism. **Curie's law** shows that paramagnetism is inversely proportional to temperature.

$$\chi_m = A + \frac{C}{T}$$

where T is the absolute temperature and A and C are constants. In the Gouy or Faraday methods, magnetic moments are calculated from the change of weight of a sample suspended between magnets when a magnetic field is applied. In addition to these methods, the highly sensitive SQUID (superconducting quantum interference device) has been used recently to carry out such measurements.

Paramagnetism is induced by the permanent magnetic moment of an unpaired electron in a molecule and the molar susceptibility is proportional to the electron spin angular momentum. Paramagnetic complexes of d -block transition metals have unpaired

electrons of spin quantum number 1/2, and a half of the number of unpaired electrons is the total spin quantum number S.

Therefore, the magnetic moment based only on spins can be derived theoretically.

$$\mu = 2\sqrt{S(S+1)}\mu_B = \sqrt{n(n+2)}\mu_B$$

Here $\mu_B = 9.274 \times 10^{-24} \text{ JT}^{-1}$ is a unit called the Bohr magneton.

Many 3d metal complexes show good agreement between the magnetic moments of paramagnetic complexes measured by a magnetic balance with the values calculated by the above formula. The relationship between the number of unpaired electrons and magnetic susceptibility of a complex is shown in Table 6.3. Because of this agreement with theory, it is possible to determine the number of unpaired electrons from experimental values of magnetic measurements. For example, it can be assumed that a $\text{Fe}^{3+} d^5$ complex with a magnetic moment of about $1.7 \mu_B$ is a low-spin complex with an unpaired spin but a $\text{Fe}^{3+} d^5$ complex with a moment of about $5.9 \mu_B$ is a high-spin complex with 5 unpaired electrons.

Table 6.3 Unpaired electrons and magnetic moments

Metal ion	Unpaired electron n	Spin-only magnetic moment (μ/μ_B)	
		Calculated	Measured
Ti^{3+}	1	1.73	1.7~1.8
V^{3+}	2	2.83	2.7~2.9
Cr^{3+}	3	3.87	3.8
Mn^{3+}	4	4.90	4.8~4.9
Fe^{3+}	5	5.92	5.9

However, the measured magnetic moment no longer agrees with the calculated spin-only value when the orbital angular momentum contribution to the magnetic moment becomes large.. Especially in 5d metal complexes, this discrepancy between the measured and calculated values increases.

Exercise 6.3 Calculate the spin-only magnetic moments of high spin and low spin Fe^{3+} complexes.

"Answer" Since they are d^6 complexes, a high spin complex has four unpaired electrons with the magnetic moment is $4.90\mu_B$ and a low spin complex has no unpaired electron and is diamagnetic.

Some paramagnetic solid materials become **ferromagnetic** at low temperatures by forming **magnetic domains** in which thousands of electron spins are aligned parallel to each other. The temperature at which the paramagnetic-ferromagnetic phase transition occurs is called the **Curie temperature**. When spins are aligned antiparallel to each other, the material changes to an **antiferromagnetic substance**, and this transition temperature is called the **Néel temperature**. The material becomes ferrimagnetic when the spins are incompletely canceled. Recently, attempts have been made to synthesize polynuclear multi-spin complexes with special ligands that make paramagnetic metal ions align to induce ferromagnetic interactions between the spins. This effect is impossible in mononuclear complexes.

6.3 Organometallic Chemistry of d Block Metals

The organometallic chemistry of transition metals is comparatively new. Although an ethylene complex of platinum called **Zeise's salt**, $K[PtCl_3(C_2H_4)]$, tetracarbonylnickel, $Ni(CO)_4$, and pentacarbonyliron, $Fe(CO)_5$, which today are classified as organometallic compounds, were prepared in the 19th century, their bonding and structures were unknown. The research of W. Hieber and others on metal carbonyl compounds was important in the 1930s, but the results of these studies were limited because of the underdeveloped techniques of structural analyses available at the time.

The discovery of ferrocene, $Fe(C_5H_5)_2$, in 1951 was epoch-making for the chemistry of this field. The very unique bonding mode of this complex became clear by means of single crystal X-ray structural analysis, NMR spectra, infrared spectra, *etc.*, and served as a starting point for subsequent developments in the field. It was a major discovery that ferrocene exhibited very high thermal stability in spite of the general view that the transition metal-carbon bonds were very unstable. It was also clearly demonstrated that the compound had a sandwich structure in which the five carbon atoms of the cyclopentadienyl groups bonded simultaneously to the central metal iron. While the various coordination modes of hydrocarbon ligands were determined one after another, the industrial importance of organometallic compounds of transition metals increased with the discoveries of olefin polymerization catalysts (Ziegler catalyst), homogeneous hydrogenation catalysts (Wilkinson catalyst), and development of catalysts for asymmetric synthesis, *etc.* The Nobel prize awarded to K. Ziegler, G. Natta (1963), E. O. Fischer, and G. Wilkinson (1973) was in recognition of this importance.

According to the definition of an organometallic compound, at least one direct bond between a metal and a carbon atom should exist, but CN complexes *etc.* with no organometallic character are usually excluded from organometallic compounds. Metal

carbonyl compounds are organometallic in various aspects of their bonding, structure and reactions, and they are a good model system for understanding of the essence of transition metal organometallic chemistry.

(a) Metal carbonyl compounds

Binary metal carbonyl compounds that consist only of a metal and CO ligands are usually prepared by the direct reaction of the powder of a highly reactive metal and carbon monoxide, or by the reduction of a metal salt to zero valance followed by reaction with high-pressure carbon monoxide. However, tetracarbonylnickel, first discovered at the end of the 19th century, forms by the reaction of nickel metal and carbon monoxide under atmospheric pressure and at room temperature. The preparation of other metal carbonyl compounds, on the other hand, requires high temperatures and high pressures.

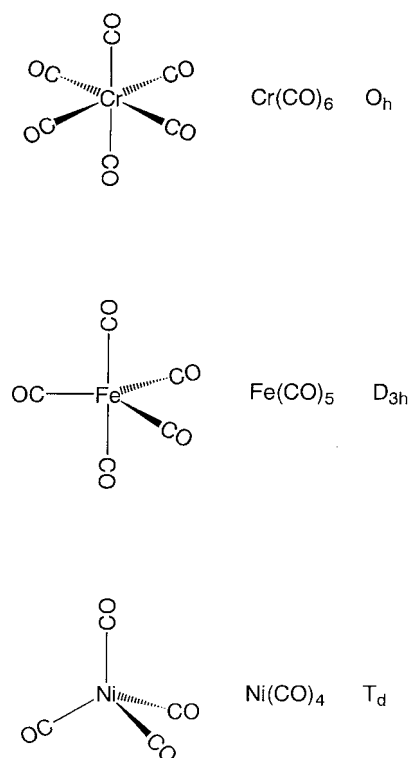

Fig. 6.14 Structures of metal carbonyl compounds.

Mononuclear metal carbonyl compounds take highly symmetric polyhedral coordination structures. Hexa-coordinate chromium, molybdenum, and tungsten hexacarbonyl, $M(CO)_6$, assume a regular octahedral, penta-coordinate pentacarbonyliron,

$\text{Fe}(\text{CO})_5$, a triangular bipyramid, and tetracarbonylnickel, $\text{Ni}(\text{CO})_4$, a regular tetrahedron coordination structure (Fig. 6.14). The carbon atoms of carbonyl ligands coordinate to the metal, and the CO moieties are oriented along the direction of the metal-carbon axis. Binuclear metal carbonyl $\text{Mn}_2(\text{CO})_{10}$ has an Mn-Mn bond joining two square pyramidal $\text{Mn}(\text{CO})_5$ parts. In $\text{Fe}_2(\text{CO})_9$, two $\text{Fe}(\text{CO})_3$ sub-units are bridged by three CO ligands, and in $\text{Co}_2(\text{CO})_8$, two $\text{Co}(\text{CO})_3$ sub-units are connected by both three CO bridges and a Co-Co bond.

There are a number of cluster metal carbonyl compounds with metal-metal bonds joining three or more metals, and terminal CO, μ -CO (a bridge between two metals), and μ_3 -CO (a bridge capping three metals) are coordinated to the metal frames (refer to Section 6.3 (f)). Many cluster carbonyls are formed by a pyrolysis reaction of mononuclear or binuclear carbonyl compounds. Typical metal carbonyl compounds and their properties are shown in Table 6.4.

Table 6.4 Stable metal carbonyl compounds

	5	6	7	8	9	10
4	$\text{V}(\text{CO})_6$ Black solid d.70	$\text{Cr}(\text{CO})_6$ White solid d.130	$\text{Mn}_2(\text{CO})_{10}$ Yellow solid mp 154	$\text{Fe}(\text{CO})_5$ Yellow liquid bp 103	$\text{Co}_2(\text{CO})_8$ Red solid mp 51	$\text{Ni}(\text{CO})_4$ Colorless liquid bp 42.1
5		$\text{Mo}(\text{CO})_6$ White solid sublime	$\text{Tc}_2(\text{CO})_{10}$ White solid mp 160	$\text{Ru}_3(\text{CO})_{12}$ Orange solid d.150	$\text{Rh}_6(\text{CO})_{16}$ Black solid d.220	
6		$\text{W}(\text{CO})_6$ White solid sublime	$\text{Re}_2(\text{CO})_{10}$ White solid mp 177	$\text{Os}_3(\text{CO})_{12}$ Orange solid mp 224	$\text{Ir}_4(\text{CO})_{12}$ Yellow solid d.220	

Back donation

A metal carbonyl compound consists of carbon monoxide coordinated to a zero valent metal. For a long time, it had been unclear why such bonding was possible, let alone stable at all. The belief that normal coordination bonds were formed by the donation of electrons from highly basic ligands to a metal formed the basis of the coordination theory of A. Werner. Because the basicity of carbon monoxide is very low, and transition metal-carbon bonds are generally not very stable, a suitable explanation for the stability of metal carbonyl compounds was sought. If the shape and symmetry of the metal d orbital and of the CO π (antibonding) orbital for the carbon-oxygen bond are

suitable for overlap, a bonding interaction between the metal and carbon is expected. The bonding scheme shown in Fig. 6.15 was proposed from this point of view. The mechanism by which electrons are donated to the vacant carbon monoxide π^* orbital from the filled metal d orbital is called **back donation**. Since accumulation of superfluous electrons on a low oxidation state metal atom is prevented, back-donation leads to the stabilization of the M-C bond.

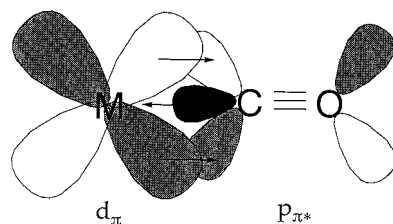

Fig 6.15 Back donation in metal carbonyls.

A rise in the order of the metal - carbon bond is reflected in the increase of the M-C, and decrease of the C-O, stretching frequencies in vibrational spectra. Infrared spectra are useful because carbonyl frequencies are easily detectable. The lowering of the oxidation state of a metal by the flow of negative charge from its coordinated ligands is reflected in the reduction of the C-O stretching frequencies.

(b) Hydrocarbon complexes

An organometallic compound is one which has metal-carbon bonds, and between one and eight carbon atoms in a hydrocarbon ligand bond to a metal. **Hapticity** describes the number of atoms in a ligand that have direct coordinative interaction with the metal and the number is added to η . An example is η^5 (pentahapto)-cyclopentadienyl (Table 6.5).

A ligand that donates an odd number of electrons to a metal is formally a radical and it is stabilized by bonding to the metal. A ligand that donates an even number of electrons to a metal is generally a neutral molecule and it is stable even if it is not bonded to the metal. Carbene or carbyne ligands are exceptions to this rule. The chemical formula of an organometallic compound is expressed in many cases without using the square brackets [] usual for such a complex, and we shall follow this convention in this book.

Table 6.5 Hapticity and number of donating electrons of hydrocarbon ligands

Name	Hapticity	Number of electrons	Example
Alkyl	η^1	1	$\text{W}(\text{CH}_3)_6$
Alkylidene	η^1	2	$\text{Cr}(\text{CO})_5\{\text{C}(\text{OCH}_3)\text{C}_6\text{H}_5\}$
Alkene	η^2	2	$\text{K}[\text{PtCl}_3(\text{C}_2\text{H}_4)]$
π -allyl	η^3	3	$\text{Ni}(\eta^3\text{-C}_3\text{H}_5)_2$
Diene	η^4	4	$\text{Fe}(\text{CO})_3(\eta^4\text{-C}_4\text{H}_6)$
Cyclopentadienyl	η^5	5	$\text{Fe}(\eta^5\text{-C}_5\text{H}_5)_2$
Arene	η^6	6	$\text{Cr}(\eta^6\text{-C}_6\text{H}_6)_2$
Tropylium	η^7	7	$\text{V}(\text{CO})_3(\eta^7\text{-C}_7\text{H}_7)$
Cyclooctatetraene	η^8	8	$\text{U}(\eta^8\text{-C}_8\text{H}_8)_2$

Exercise 6.4 Describe the difference between cyclopentadiene and cyclopentadienyl ligands.

“Answer” The chemical formula of cyclopentadiene is C_5H_6 and it is bonded to a metal as a η^2 or η^4 ligand. The chemical formula of cyclopentadienyl is C_5H_5 and it is bonded to a metal as a η^1 , η^3 , or η^5 ligand.

Alkyl ligands

Alkyl or aryl transition metal compounds have M-C single bonds. In spite of many attempts over most of the course of chemical history, their isolation was unsuccessful and it was long considered that all M-C bonds were essentially unstable. Stable alkyl complexes began to be prepared gradually only from the 1950s. $\text{Cp}_2\text{ZrCl}(\text{Pr})$, WMe_6 , $\text{CpFeMe}(\text{CO})_2$, $\text{CoMe}(\text{py})(\text{dmg})_2$, (dmg = dimethylglyoximate), $\text{IrCl}(\text{X})(\text{Et})(\text{CO})(\text{PPh}_3)_2$, $\text{NiEt}_2(\text{bipy})$, $\text{PtCl}(\text{Et})(\text{PEt}_3)_2$ are some representative compounds. Among various synthetic processes so far developed, the reactions of compounds containing M-halogen bonds with main-group metal-alkyl compounds, such as a Grignard reagent or an organolithium compound, are common synthetic routes. Especially vitamin B_{12} , of which D. Hodgkin (1964 Nobel Prize) determined the structure, is known to have a very stable Co-C bond. Metal alkyl compounds which have only alkyl ligand, such as WMe_6 , are called **homoleptic alkyls**.

It is gradually accepted that a major cause of the instability of alkyl complexes is the low activation energy of their decomposition rather than a low M-C bond energy. The most general decomposition path is **β elimination**. Namely, the bonding interaction of a hydrocarbon ligand with the central transition metal tends to result in the formation of a metal hydride and an olefin. Such an interaction is called an **agostic interaction**.

Although an alkyl and an aryl ligand are 1-electron ligands, they are regarded as anions when the oxidation number of the metal is counted. The hydride ligand, H, resembles the alkyl ligand in this aspect.

π allyl complexes

If an allyl group, $\text{CH}_2=\text{CH}-\text{CH}_2-$, is bonded to a metal via a carbon atom, it is a 1-electron ligand like an alkyl group. If the double bond delocalizes, three carbon atoms bond to the metal simultaneously as a 3-electron ligand. This is also an odd electron and formally anionic ligand and is stabilized by being coordinated to the metal.

$\text{Pd}(\text{C}_3\text{H}_5)(\text{Ac})(\text{PPh}_3)$, $\text{Co}(\text{C}_3\text{H}_5)_3$, *etc.* are well-known examples. Since η^1 , η^2 , and η^3 coordination modes are possible in the catalytic reactions of unsaturated hydrocarbons, various reactions occur.

π cyclopentadienyl complexes

The cyclopentadienyl ligand, C_5H_5 , is abbreviated as Cp. C_5Me_5 , in which the hydrogen atoms of Cp are replaced with methyl groups, is a useful ligand called **Cp star** and is denoted by Cp*. Ferrocene, Cp_2Fe , is a very stable orange-colored iron compound in which two cyclopentadienyl groups are bonded to iron. It was discovered independently in two laboratories, but the discoverers proposed incorrect structures. The correct structure was clarified by the group of G. Wilkinson, who won a Nobel Prize (1973). The preparation of ferrocene is usually carried out according to the following reaction path:

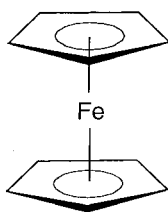
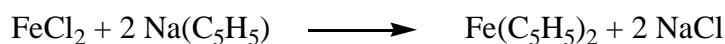
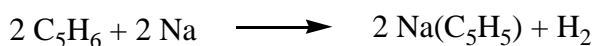

Fig. 6.16 Structure of ferrocene.

Single crystal X-ray structure analysis showed that the structure of ferrocene is an iron

atom sandwiched between two C_5H_5 rings (Fig. 6.16). Five carbon atoms bond to the iron simultaneously in ferrocene, and unsaturated C-C bonds are delocalized in the five-membered rings. Since this kind of bond was not known before, it aroused interest, many derivative compounds were prepared, and a wide range of chemistry has since been studied (Table 6.6).

Table 6.6 Typical sandwich compounds (Cp = $\eta^5-C_5H_5$)

	4	5	6	7	8	9	10
4	Cp ₂ TiCl ₂ Red mp 230	Cp ₂ V Black mp 167	Cp ₂ Cr Scarlet mp 173	Cp ₂ Mn Brown mp 193	Cp ₂ Fe Orange mp 174	Cp ₂ Co Black mp 173	Cp ₂ Ni Green d.173
5	Cp ₂ ZrCl ₂ White mp 248	Cp ₂ NbCl ₂ Brown	Cp ₂ MoCl ₂ Green d.270	Cp ₂ TcH Yellow mp 150	Cp ₂ Ru Yellow mp 200		
6	Cp ₂ HfCl ₂ White mp 234	Cp ₂ TaCl ₂ Brown	Cp ₂ WCl ₂ Green d.250	Cp ₂ ReH Yellow mp 161	Cp ₂ Os White mp 229		

The cyclopentadienyl ligand is a 5-electron and formally anionic ligand. If only one of the five carbon atoms is bonded to a metal, it is a 1-electron ligand like an alkyl group. It becomes a 3-electron ligand in rare cases and coordinates to a metal as a π -allyl system that extends over 3 carbon atoms. The Cp group of ferrocene has reactivity analogous to that of aromatic compounds. Since the Cp group has played a significant role as a stabilizing ligand to realize the preparation of new compounds with new metal-ligand bonding modes, it can reasonably be claimed that this ligand has made the greatest contribution to organometallic chemistry of any other ligand. Although two Cp rings are bonded to the metal in parallel in ferrocene, Cp₂TiCl₂ and Cp₂MoH₂ have bent Cp ligands and they are called bent-sandwich compounds.

Olefin complexes

Zeise's salt, K[PtCl₃(C₂H₄)], is the oldest known organometallic compound and was synthesized and analyzed in *ca.* 1825 by Zeise, although its coordination structure was assumed only in 1954 and confirmed by the neutron diffraction in 1975. The mode of coordination of an olefin to a transition metal is described by the Dewar-Chatt-Duncanson model and the bond between the metal and olefin is stabilized by the contribution of $d_{\pi}-p_{\pi}^*$ back donation. An olefin is a 2-electron ligand and there are many olefin complexes in which the central metal is in a relatively low oxidation state.

Dienes or trienes with two or more double bonds coordinate to a metal as 4-electron or 6-electron ligands. Fe(CO)₃(C₄H₆) and Ni(cod)₂, in which a butadiene or

cyclooctadienes (cod) are coordinated to the metal, are well known examples. Since cyclooctadienes are easily eliminated from $\text{Ni}(\text{cod})_2$, it is conveniently used for generating atomic, zero valent nickel. This complex is sometimes called **naked nickel**.

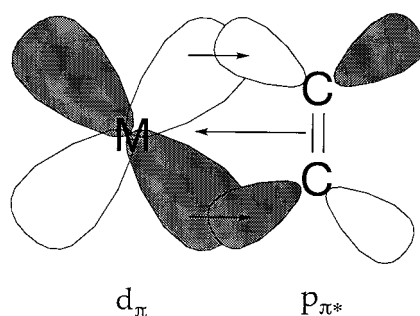

Fig. 6.17 Back-donation in olefin complexes.

Arene complexes

Aromatic compounds are 6-electron donors that coordinate to transition metals in the η^6 coordination mode with six carbon atoms. Bisbenzenechromium, $\text{Cr}(\text{C}_6\text{H}_6)_2$, is a typical example of such a compound. The compound is prepared by reducing chromium chloride in benzene and it has a sandwich structure in which a chromium atom is inserted between two benzene rings. When a benzene ligand is replaced by three carbonyls, $\text{Cr}(\text{CO})_3(\text{C}_6\text{H}_6)$ is obtained.

18 electron rule

Counting valence electrons is of utmost importance in chemistry. Changes in the number of valence electrons has a profound influence on the bonding, structure, and reactions of a compound. Since both the metal and organic moieties are involved in organometallic compounds, counting the number of electrons becomes complicated. Hydrocarbyl ligands are classified as either neutral molecules coordinating to the metal or radicals bonding to the metal, and the radicals, such as alkyls and cyclopentadienyl, are generally called anionic ligands. Transfer of one electron from the metal to the radical ligand makes the ligand formally anionic. However, it is less confusing to consider that both the metal and the ligands are neutral when counting the number of valence electrons. The numbers of donor electrons in typical carbon ligands from this viewpoint are listed in Table 6.5. It is important to note that even in the same ligand, the number of donor

electrons supplied by the ligand differs depending upon the number of ligating atoms that have coordinative interactions with the metal. For example, 1, 3 or 5 electrons can be donated from a cyclopentadienyl ligand, depending on the type of coordinative interactions with the metal.

When the total number of valence electrons of the metal and ligands is 18, a transition metal organometallic compound usually has high thermal stability. For example, $\text{Cr}(\text{CO})_6$, $\text{Fe}(\text{CO})_5$, $\text{Ni}(\text{CO})_4$, $\text{Fe}(\text{C}_5\text{H}_5)_2$, $\text{Mo}(\text{C}_6\text{H}_6)(\text{CO})_3$ *etc.* satisfy the **18 electron rule**, but the monomeric parts of $\text{Mn}_2(\text{CO})_{10}$, $\text{Co}_2(\text{CO})_8$ or $[\text{Fe}(\text{C}_5\text{H}_5)(\text{CO})_2]_2$ have only 17 electrons and the extra electron comes from the partner metal by forming a metal-metal bond. Unlike the 8 electron rule in main group compounds, applicability of the 18 electron rule is limited. That is to say, it is a sufficient condition but compounds with high thermal stability are not necessarily 18 electron compounds.

Although there are many Group 6 (chromium group) through Group 9 (cobalt group) organometallic compounds with carbonyl or cyclopentadienyl ligands that satisfy the 18 electron rule, many compounds of the early transition metals (Group 3 - 5) and Group 10 (nickel group) fail to conform to this rule. For example, $\text{W}(\text{CH}_3)_6$ (12e), $\text{TiCl}_2(\text{C}_5\text{H}_5)_2$ (16e), and $\text{IrCl}_2(\text{CO})(\text{PPh}_3)_2$ (16e), $\text{V}(\text{CO})_6$ (17e), $\text{Co}(\text{C}_5\text{H}_5)_2$ (19e), $\text{Ni}(\text{C}_5\text{H}_5)_2$ (20e), *etc.* do not satisfy the 18 electron rule. However, the 18 electron rule provides useful clues as to the bonding modes present in a given complex. For example, $\text{Fe}(\text{C}_5\text{H}_5)_2(\text{CO})_2$ with two pentahapto cyclopentadienyl ligands formally has 22 electrons but if one of the ligands is monohapto, the compound has 18 electrons. Structural analysis has shown that this is the actual coordination of this complex.

Exercise 6.5 Calculate the valence electron number of $\text{CpMn}(\text{CO})_3$.

“Answer” They are a total of 18 electrons from Mn (7), Cp(5) and three CO(6).

(c) Phosphine complexes

Tertiary phosphines, PX_3 , are very useful as stabilization ligands in transition metal complexes and they coordinate to the metals in relatively high to low oxidation states. Phosphines are frequently used as carbonyl or cyclopentadienyl ligands in the chemistry of organometallic complexes. PX_3 are Lewis bases and coordinate to the metal using the lone pair on phosphorus and show π -acidity when carrying substituents X including Ph, Cl, or F that have strong electron accepting properties. The electronic flexibility of PX_3 is the reason it forms so many complexes. Generally, the π -acidity becomes smaller in the order $\text{PF}_3 > \text{PCl}_3 > \text{PPh}_3 > \text{PR}_3$. Triphenylphosphine and triethylphosphine are typical substituted phosphines. The tertiaryphosphine complexes mainly of metal halides are listed in Table 6.7. Manganese, Mn, and the early transition metals form very few

phosphine complexes.

Table 6.7 Typical tertiary phosphine complexes (dmpe = 1,2-bisdimethylphosphinoethane; dppe = 1,2-bisdiphenylphosphinoethane)

	4	5	6	7
4	[TiCl ₄ (PPh ₃) ₂]	[VCl ₃ (PMePh ₂) ₂]	[CrCl ₂ (dmpe) ₂]	[Mn(CO) ₄ (PPh ₃)]
5	[ZrCl ₄ (dppe)]	[NbCl ₄ (PEtPh ₂) ₂]	[MoCl ₃ (PMePh ₂) ₃]	[TcCl ₃ (PMe ₂ Ph) ₃]
6	[HfCl ₄ (dppe)]	[TaCl ₄ (PEt ₃) ₂]	[WCl ₄ (PPh ₃) ₂]	[ReCl ₃ (PMe ₂ Ph) ₃]

	8	9	10	11
4	[FeCl ₂ (PPh ₃) ₂]	[CoCl ₂ (PPh ₃) ₂]	[NiCl ₂ (PEt ₃) ₂]	[CuBr(PEt ₃) ₄]
5	[RuCl ₂ (PPh ₃) ₃]	[RhCl(PPh ₃) ₃]	[PdCl ₂ (PPh ₃) ₂]	[AgCl(PPh ₃)]
6	[OsCl ₃ (PPh ₃) ₃]	[IrCl ₃ (PPh ₃) ₃]	[PtCl ₂ (PPh ₃) ₂]	[AuCl(PPh ₃)]

Many derivatives can be prepared by substituting the halogens of the phosphine complexes. A number of the complexes of polydentate phosphines with more than two coordination sites, as well as those of monodentate phosphines, have been prepared, and they are used also as stabilization ligands in hydride, alkyl, dinitrogen, and dihydrogen complexes. The complexes of rhodium or ruthenium, in which optically active phosphines are coordinated, are excellent catalysts for asymmetric synthesis.

(d) Small molecule complexes

Two or three atomic molecules, such as H₂, N₂, CO, NO, CO₂, NO₂, and H₂O, SO₂, *etc.*, are called **small molecules** and the chemistry of their complexes is very important not only for basic inorganic chemistry but also for catalyst chemistry, bioinorganic chemistry, industrial chemistry, and environmental chemistry. The complexes of small molecules other than water and carbon monoxide were synthesized comparatively recently. Dihydrogen complexes in particular were reported only in 1984.

Dihydrogen complexes

The oxidative addition reaction of a hydrogen molecule, H₂, is one of the methods used to generate the M-H bond of a hydride complex. Schematically, the above reaction is written as

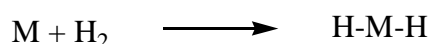

but it was believed that there must be an intermediate complex containing a coordinated

dihydrogen. The first example of a stable complex of this sort, $[\text{W}(\text{CO})_3(\text{H}_2)(\text{P}^i\text{Pr}_3)_2]$, was reported by G. Kubas in 1984 (Fig. 6.18). It was proved by the neutron diffraction that the H_2 is coordinated as an η^2 ligand by maintaining the bond between hydrogen atoms with an interatomic distance of 84 pm.

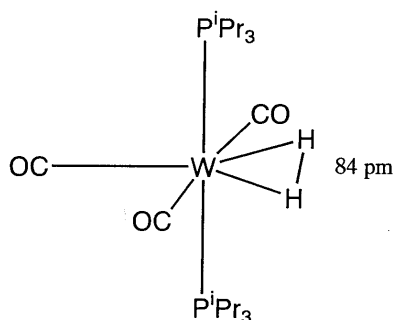

Fig. 6.18 Structure of $[\text{W}(\text{CO})_3(\text{H}_2)(\text{P}^i\text{Pr}_3)_2]$.

Once this new coordination mode was established, new dihydrogen complexes have been prepared one after another, and dozens of dihydrogen complexes are now known. Dihydrogen complexes are interesting not only from the viewpoint of bond theory but they have also greatly contributed to the study of the activation process of the hydrogen molecule.

Dinitrogen complexes

Since N_2 is isoelectronic with CO , the possible stability of dinitrogen complexes analogous in structure to carbonyl complexes was the subject of speculation for many years. These compounds generated great interest because of the parallels with the interaction and activation of nitrogen molecules on the iron catalyst used in ammonia synthesis and the nitrogen fixing enzyme nitrogenase. However, the first dinitrogen complex, $[\text{Ru}(\text{N}_2)(\text{NH}_3)_5]\text{X}_2$, was prepared by A. D. Allen (1965) unexpectedly from the reaction of a ruthenium complex and hydrazine. Subsequently, it was discovered by chance that nitrogen gas coordinates to cobalt, and $[\text{CoH}(\text{N}_2)(\text{PPh}_3)_3]$ was prepared in 1967 (Fig. 6.19). Many dinitrogen complexes have been prepared since these early beginnings.

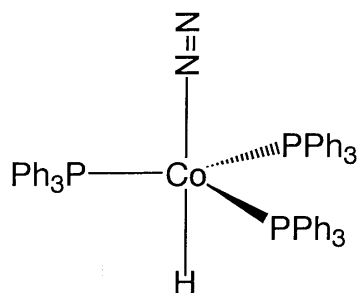
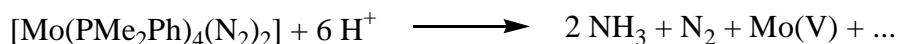

Fig. 6.19 Structure of $[\text{CoH}(\text{N}_2)(\text{PPh}_3)_3]$.

In most dinitrogen complexes, N_2 is coordinated to the metal by one nitrogen atom. That is to say, the $\text{M}-\text{N}\equiv\text{N}$ bond is common and there are few complexes in which both nitrogen atoms bond to the metal in the η^2 coordination mode. In 1975, the coordinated dinitrogen in a molybdenum complex was discovered to be protonated by mineral acids to form ammonia, as described in the following reaction. The electrons required for the reduction are supplied by the molybdenum in a low oxidation state as this reaction shows.



In spite of attempts to prepare ammonia and organic nitrogen compounds from various dinitrogen complexes, no nitrogen fixation system which is equal to biological systems has yet been discovered. Ammonia synthesis is a long-established industrial process, and its parameters have been extensively studied and little room for improvement remains. However, elucidating the mechanism of the biological nitrogen fixation reaction at ordinary temperatures and pressures remains one of the major challenges of bio-inorganic chemistry.

Dioxygen complexes

Although it has long been recognized that schiff base complexes of cobalt absorb oxygen, the discovery that **Vaska's complex**, $[\text{IrCl}(\text{CO})(\text{PPh}_3)_2]$, coordinates dioxygen reversibly to form $[\text{IrCl}(\text{CO})(\text{PPh}_3)_2(\text{O}_2)]$ was very significant. In this complex, two oxygen atoms bond to iridium (side-on), and dioxygen has a peroxide character (O_2^{2-}). However, many superoxide (O_2^-) complexes in which only one oxygen atom is bonded to the metal are known. There are also binuclear dioxygen complexes in which O_2 bridges two metals. The relation between reversible coordination of dioxygen and its reactivity is important in relation to the behavior of dioxygen in living systems (refer to Section 8.2 (a)).

(e) Metal-metal bonds

The concept of the formation of a coordinate bond between ligands and a central metal proposed by A. Werner was the basis for the development of the chemistry of complexes. The bonding mode and structures of known complexes have become the guidepost of the preparation of a much larger number of new complexes. For most of the dinuclear or polynuclear complexes that contain two or more metals in a complex, it was sufficient to take into consideration only the bonds between the metal and ligands.

The concept of direct bonds between metals was born of the necessity of explaining the structural chemistry of the dinuclear metal carbonyls that have a partial structure with an odd number of electrons. Two $\text{Mn}(\text{CO})_5$ units in $\text{Mn}_2(\text{CO})_{10}$ are connected by a direct Mn-Mn bond (Fig. 6.20) without the help of bridge ligands. According to X-ray structural analysis (1963), the Mn-Mn distance of 292 pm was significantly longer than twice that of the metal radius of 127 pm but a Mn-Mn direct bond was envisaged in the absence of a bridge carbonyl ligand. This compound's diamagnetism indicates a structure with an even number of electrons (18 electrons) by sharing electrons between two d^7 -Mn (17 electrons) moieties, each with five carbonyl ligands.

Similarly, it can be concluded that $\text{Co}_2(\text{CO})_8$, with two bridging carbonyl ligands, should have a direct Co-Co bond to be compatible with its diamagnetism.

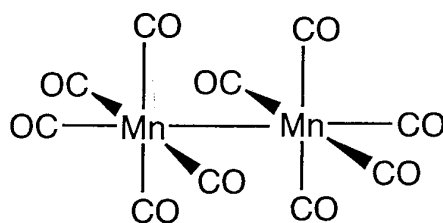

Fig. 6.20 Structure of $\text{Mn}_2(\text{CO})_{10}$.

The concept of the single bond between metals introduced for dinuclear metal carbonyl compounds is also very useful in explaining the structure of cluster carbonyl compounds containing two or more metals. The metal-metal bond has been established today as one of the common bonding modes, together with the metal-ligand bond, present in coordination complexes. However, it is not always clear to what extent the interaction between metals exists in the polynuclear complexes which have bridging ligands. As a criterion, the bond order can be evaluated from the bond distance in standard metals (for example, in bulk metals). However, even if the bond distance between metals analyzed by

X-ray is sufficiently short, this does not prove the existence of a bond between metals unless the orbital conditions to account for such bonds are also fulfilled.

M-M multiple bonds

There are many dinuclear compounds in which the metal atoms are bound by multiple bonds with bond orders of 2 to 4. The M-M quadrupole bond was proposed first for $\text{Re}_2\text{Cl}_8^{2-}$, and this remains the best-known example (Fig. 6.21). The Re-Re distance in this compound is only 224 pm, which is unusually short compared with the Re-Re distance of 275 pm in rhenium metal. Another unusual feature is that the ReCl_4 units assume an **eclipsed** configuration (chlorine atoms overlap along the direction of the Re-Re bond) even though the **staggered** configuration (in which chlorine atoms do not overlap along the Re-Re bond direction) should be more stable because the distance between ReCl_4 units is very short, resulting in the distances between the chlorine atoms being very short (experimental value of 332 pm). As a result, the repulsive interaction between the chlorine atoms becomes strong.

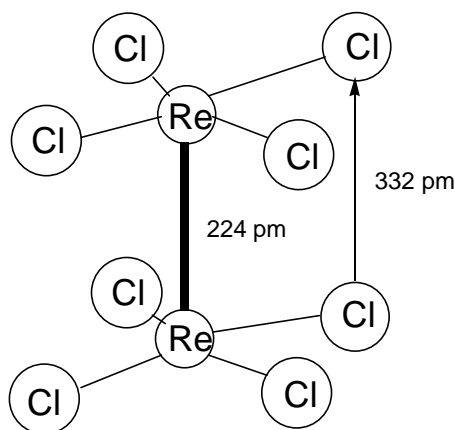

Fig. 6.21 Structure of $\text{Re}_2\text{Cl}_8^{2-}$.

F. A. Cotton explained this anomaly by introducing the concept of the delta bond between metals in 1964. Namely, if one takes the z-axis in the direction of the Re-Re bond, a σ bond is formed between the d_{z^2} , the π bonds between d_{yz} and d_{xz} orbitals and the δ bond between d_{xy} orbitals among the five d orbitals. $d_{x^2-y^2}$ is mainly used for the Re-Cl bond. The delta bond is formed by a weak sideways overlap of d_{xy} orbitals, when they are located perpendicular to the direction of the metal-metal bond axis and become eclipsed (Fig. 6.22). Therefore, although the δ bond is relatively weak among bonding interactions, it is sufficient to maintain the chlorine ligands in their eclipsed positions.

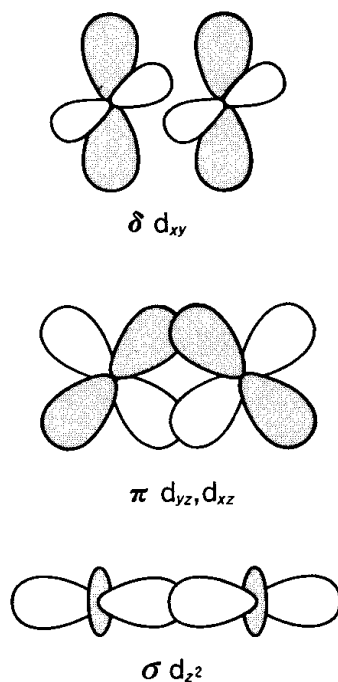

Fig. 6.22 Overlap of d orbitals in $\text{Re}\equiv\text{Re}$ quadrupole bond.

The energy levels of the molecular orbitals of σ , π , and δ bonds decrease in this order, and the energy difference between the bonding and antibonding delta orbitals is small. Therefore, even if one electron is removed (oxidation) from $\text{Re}_2\text{Cl}_8^{2-}$, which has a quadruple bond, or one electron is added (reduction) to it, the Re-Re distance should hardly change.

The Mo(II) compound $[\text{Mo}_2(\text{CH}_3\text{COO})_4]$ which is isoelectronic with Re (III) has a Mo-Mo quadruple bond. $[\text{W}_2\text{Cl}_9]^{3-}$ and $[\text{W}_2(\text{NMe}_2)_6]$ are examples of compounds which have the metal-metal triple bonds. Although the issue of whether such metal-metal multiple bonds really exist has been argued many times, the concept has now been established and hundreds of dinuclear compounds with metal-metal multiple bonds are known at present. Metal-metal distances determined by X-ray analysis are most useful in determining whether a metal-metal bond is a multiple one, but as in the case of metal-metal single bonds, the bond distance alone cannot be the absolute determiner and it is necessary to draw conclusions from molecular orbital calculations.

(f) Metal cluster compounds

Analysis of the structures of newly prepared polynuclear complexes that contain

two or more metals was, until recently, very difficult. However, with the progress of single crystal X-ray structural analysis, our understanding of the chemistry of polynuclear complexes is progressing quickly. Metal-cluster complexes are polynuclear complexes built by three or more transition-metal atoms with bonds between the metals coordinated by ligands to form polyhedral frames, such as a triangle, a regular tetrahedron, a regular octahedron, and an icosahedron. Even if there is no strong bond between metals, as long as there is some bonding interaction, they may be included as cluster compounds.

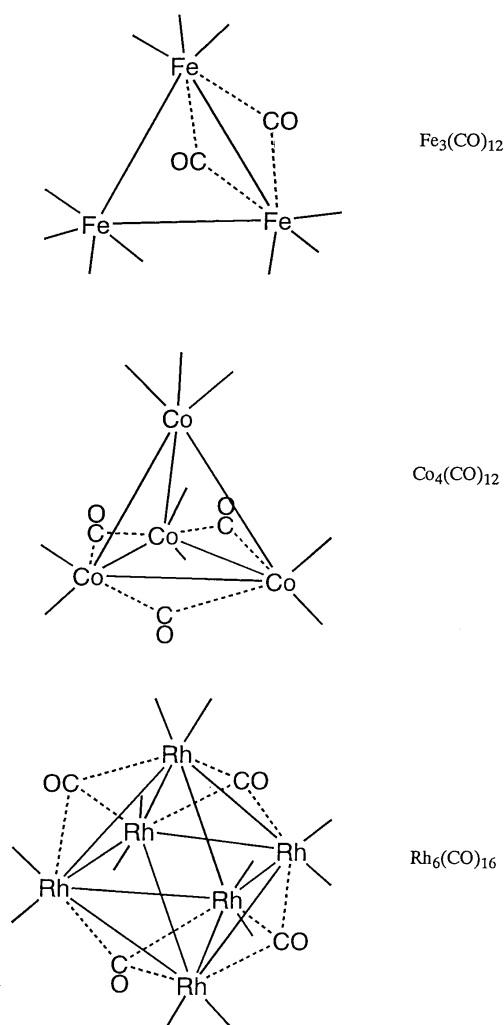

Fig. 6.23 Examples of metal cluster carbonyls (terminal carbonyl ligands are omitted for clarity).

Metal cluster complexes may be broadly classified into groups according to the general character of the associated ligands. They are low oxidation state metal clusters

with π -acceptor ligands like carbonyls (CO), isonitriles (RNC) or phosphines (PR_3) and with π -donor ligands like oxygen (O), sulfur (S), chlorine (Cl) or alkoxides (OR). Many carbonyl cluster and sulfur cluster compounds have been synthesized. Carbonyl cluster compounds are obtained by heating or irradiating mononuclear carbonyl compounds. The chemical properties of cluster compounds such as $\text{Fe}_3(\text{CO})_{12}$, $\text{Ru}_3(\text{CO})_{12}$, $\text{Os}_3(\text{CO})_{12}$, $\text{Co}_4(\text{CO})_{12}$, $\text{Ir}_4(\text{CO})_{12}$ or $\text{Rh}_6(\text{CO})_{16}$ have been studied in detail (Fig. 6.23).

Since $\text{Os}_3(\text{CO})_{12}$ forms many kinds of cluster compounds by pyrolysis, it has been used to study the skeletal structures of osmium cluster compounds and their relationship to skeletal electron numbers. A M-M bond is satisfactorily described by the 2 center 2 electron bond and the 18 electron rule is also applicable to each metal for small clusters such as a triangle and a regular tetrahedron. When clusters become large, the Wade rule that describes the relation between the structures of boranes and skeletal electron numbers, or the Lauher rule that draws the number of the bonding metal-metal orbitals for various metal polyhedral structures from the molecular orbital calculations of bare rhodium clusters without ligands, are more applicable. The relationship between the number of cluster valence electrons and the cluster's polyhedral shape as shown in Table 6.8 has contributed much to the theory of cluster chemistry.

Table 6.8 Metal frameworks and cluster valence electrons in metal cluster carbonyl compounds

Metal framework	Cluster valence electron	Example
Triangle	48	$\text{Fe}_3(\text{CO})_{12}$
Tetrahedron	60	$\text{Co}_4(\text{CO})_{12}$
Butterfly	62	$[\text{Fe}_4(\text{CO})_{12}\text{C}]^{2-}$
Trigonal bipyramid	72	$\text{Os}_5(\text{CO})_{16}$
Square pyramid	74	$\text{Fe}_5\text{C}(\text{CO})_{15}$
Octahedron	86	$\text{Rh}_6(\text{CO})_{16}$
Trigonal prism	90	$[\text{Rh}_6\text{C}(\text{CO})_{15}]^{2-}$

Monovalent anions such as halogens, alkoxides, carboxylate ions, and divalent anions such as oxygen and sulfur stabilize the cluster frameworks by helping metals assume oxidation states suitable for cluster formation and connect metal fragments by bridging. Since neutral ligands such as phosphines, carbonyl, or amines can also be coordinated to metals, a variety of cluster complexes have been prepared.

The halide clusters of molybdenum, Mo_6X_{12} , tungsten, W_6X_{12} , niobium, Nb_6X_{14} , and tantalum, Ta_6X_{14} , are solid cluster compounds that have been known for many years. The octahedral metal frameworks were shown by X-ray structure analysis more than 50 years ago. The molecular cluster complexes were prepared in the 1960s from solid-state

halide clusters by the reaction of ligands such as amines and phosphines, and these cluster compounds generated considerable interest for some time. New halide cluster compounds with octahedral structures have again been prepared recently and they are being studied from new perspectives. The molecular cluster complex $[\text{Mo}_6\text{S}_8\text{L}_6]$ (where L is PEt_3 , py, *etc.*), which has similar Mo_6 frameworks with those of the superconducting Chevrel phase compounds MxMo_6S_6 and their tungsten and chromium analogs have been prepared and the relationships between their structures and physical properties attract great interest (Fig. 6.24).

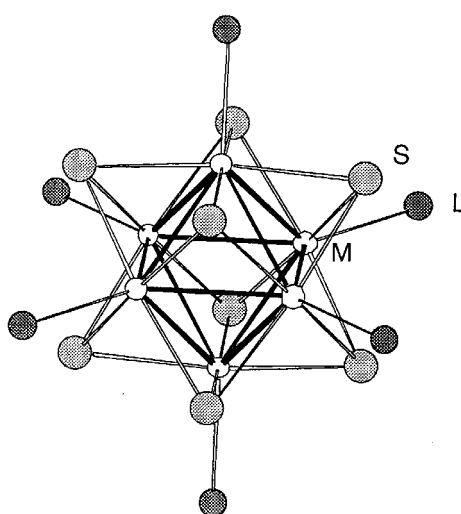

Fig. 6.24 Structure of $[\text{Mo}_6\text{S}_8\text{L}_6]$.

As will be described in the Chapter on bioinorganic chemistry, clusters such as Fe_4S_4 are contained in nitrogenase, the nitrogen-fixing enzyme, and also in the active center of ferredoxins, and they play important roles in the activation of dinitrogen or multi-electron transfer reactions. Since R. H. Holm synthesized the $\text{Fe}_4\text{S}_4(\text{SR})_4$ cluster (Fig. 6.25), our understanding of the chemistry of the iron-sulfur cluster has developed considerably.

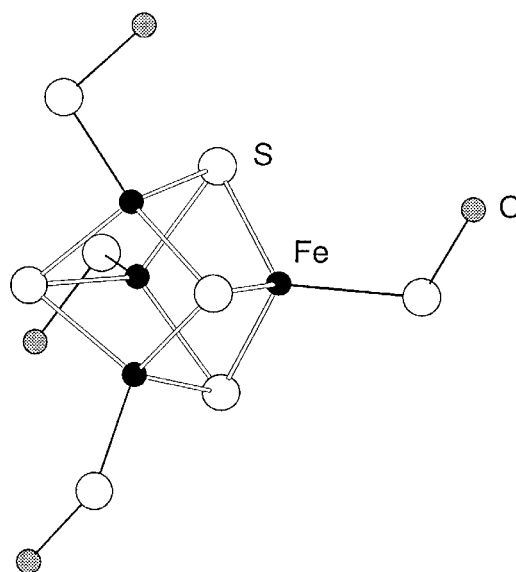

Fig. 6.25 Structure of $[\text{Fe}_4\text{S}_4(\text{SR})_4]^{2-}$.

As the metal species of metal cluster carbonyls are in near-zero valence oxidation states, they had been expected to play a role in specific catalysis. Although many organic syntheses using metal cluster compounds as catalysts have been attempted and some interesting reactions were discovered, in most cases the clusters decomposed during the reactions and they turned out to be false cluster catalysts. Despite this, there have been some examples of reactions that pass through several elementary reaction stages on the metal of the cluster. Hence, it is likely that catalytic reactions that employ the **multi-center coordination** and **multi-electron transfer** abilities of cluster compounds will be developed in the future.

Metal clusters have been helpful as models of the surfaces of bulk metals, metal oxides, or metal sulfides, and they have been useful in the study of chemisorption and successive reactions on solid surfaces. The fine metal grains which maintain the basic cluster frameworks are deposited by the pyrolysis of metal carbonyl cluster compounds chemically bonded to carriers such as silica and alumina. If used in solid catalysis, it is expected that analysis of the catalytic reaction on a metal cluster framework will be possible.

6.4 Reactions of complexes

The reactions of complexes are classified into the substitution reaction of ligands, the conversion reaction of ligands, and the redox reaction of the central metal. The

substitution and redox reactions in particular have been studied in detail.

(a) Ligand substitution reaction

Ligand substitution reactions of complexes

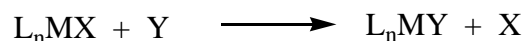

are very important for the preparation of various kinds of derivatives. The detailed conditions which complexes and ligands fulfill have been studied in order to understand their stereochemistry and attain practical rates of substitution reactions. As with other types of chemical reactions, we require an understanding of both equilibrium and reaction rates.

Formation constant

The equilibrium constant of a ligand substitution reaction is called a **formation or stability constant**. The concept and the method of computing successive formation constants were proposed by N. Bjerrum (1941). Equilibrium constants for the replacement of a hydrated ion M by other ligands L in an aqueous solution are

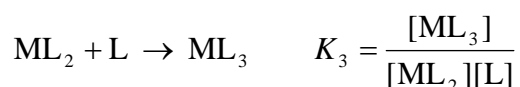
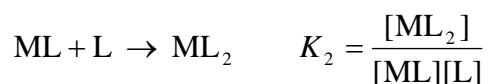

.....



and the overall formation constant β_n is

$$\beta_n = \frac{[ML_n]}{[M][L]^n} = K_1 K_2 K_3 \cdots K_n$$

The thermodynamic stability of a substitution product becomes larger as the formation constant increases.

On the other hand, an understanding of the effect of the leaving ligand, X, and the entering ligand, Y, on the substitution rate and on the intermediate species formed are essential to elucidate the reaction chemistry of metal complexes. It is especially useful to summarize the electronic structure of the central metals, the stereochemistry of complexes, and the correlation between the parameters representing their steric properties and the reaction rate. Generally, reaction mechanisms can be classified into associative, interchange, and dissociative mechanisms according to the differences in the intermediate state (Fig. 6.26).

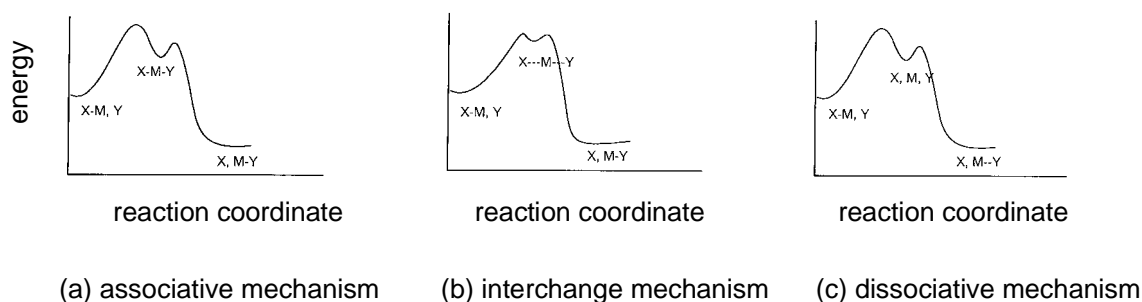

Fig. 6.26 The stability of the intermediate of ligand substitution.

Associative mechanism If the substitution rate of a ligand substitution of a complex is dependant upon the entering ligand, Y, coordinating to the central metal and is insensitive to the leaving ligand, X, it is presumed to take the associative mechanism which increases the coordination number. Such a substitution reaction is often seen in planar tetra-coordinate Pt(II) complexes, and the intermediate species are triangular bipyramidal penta-coordinate complexes. The reaction is first-order with respect to both the tetra-coordinate complex and Y, and is second-order as a whole. Since it is accompanied by a reduction of molecular species in the intermediate stage, thermodynamic measurements of the reaction indicate the activation entropy, ΔS , to be negative. The intermediate species in the case of the associative mechanism in hexa-coordinate complexes are hepta-coordinate complexes.

Interchange mechanism When the life of an intermediate state is very short, the reaction proceeds by the interchange mechanism, as the coordination of Y and

elimination of X are considered to occur simultaneously.

Dissociative mechanism A substitution reaction that is highly sensitive to the identity of the leaving ligand, X, and practically insensitive to the identity of the entering ligand, Y, assumes the dissociative mechanism in which the coordination number decreases in the intermediate state. This is often observed in octahedral hexa-coordinate complexes, and the intermediate states are penta-coordinate complexes that form by the elimination of X. As the elimination is accompanied by an increase of molecular species in the intermediate stage, the entropy of activation, ΔS , becomes positive.

Exercise 6.6 The order of the rate of ligand substitution of Pt(II) complexes is $\text{H}_2\text{O} < \text{Cl}^- < \text{I}^- < \text{PR}_3 < \text{CN}^-$ for entering ligands. Which mechanism, associative or dissociative, do the substitutions take?

“Answer” Since they are dependent on the entering ligands, the associative mechanism is more likely.

Trans effect In square-planar tetra-coordinate complexes typically of Pt(II), the ligand trans to the leaving ligand X governs the substitution rate. This is called the **trans effect**. The substitution rate increases as the σ donor or π acceptor ability of the trans ligand becomes larger in the order of $\text{NH}_3 < \text{Cl}^- < \text{Br}^- < \text{I}^- < \text{NCS}^- < \text{PR}_3 < \text{CN}^- < \text{CO}$. An analogous effect may also be seen in octahedral hexa-coordinate complexes, although the effect is usually relatively small.

The H_2O exchange rate in aqua ions Inert, intermediate, and labile are classification of the exchange rate proposed by H. Taube (1952). The exchange rate of aqua ions (ions coordinated by water molecules) of main-group and transition metals differ greatly depending upon the identity of the metal species. Since the rate of water ligand exchange is well correlated with the exchange rates of other ligands, it is useful for general comparison of the exchange rates in the complexes of different metal ions. For alkali and alkaline earth metals, the exchange rates are very high (10^5 - 10^9 s^{-1}), and the complexes of these metals are classified as labile. As the dissociative mechanism is generally found in these cases, ions with smaller ionicity and of larger size attract water ligands less and their exchange rates becomes higher. In Group 12 metal ions Zn^{2+} , Cd^{2+} , Hg^{2+} , Group 13 metal ions Al^{3+} , Ga^{3+} , In^{3+} and Group 3 metal ions Sc^{3+} , Y^{3+} , rapid water ligand exchange takes place by a dissociative mechanism.

On the other hand, the exchange rates of M (II) ions in *d* block transition metal ions is medium (10 - 10^4 s^{-1}), and that of M (III) ions are lower still. The rates of $d^3 \text{ Cr}^{3+}$ and $d^6 \text{ Co}^{3+}$ are notably slow (10^{-1} - 10^{-9} s^{-1}), and their complexes are termed inert. There has been

a great deal of study of ligand-exchange reactions. The exchange rates are smaller the larger the ligand field stabilization energy. Therefore, the ligand-exchange rates of $4d$ and $5d$ transition metal complexes are generally slow.

Test tube experiments

Easy chemical or biological reactions performed in test tubes are sometimes called test tube experiments. Solutions in test tubes are mixed at room temperature in air and the mixture is shaken to observe a color change or formation of precipitates and the results of the reactions are speculated on. University professors occasionally attempt these sorts of experiments. Although easy, these simple experiments show only the effects of visible light absorption and solubility. However, since even great discoveries can be born from such experiments, they should not be dismissed.

H. Taube wrote that he found a hint of the inner-sphere electron transfer mechanism from test tube experiments. He mixed $\text{Cr}^{2+}(\text{aq})$ and I_2 in a test tube in order to clarify the oxidation of $\text{Cr}^{2+}(\text{aq})$ and observed the change of color to the one characteristic of $[\text{Cr}(\text{H}_2\text{O})_6]^{3+}$ via green. The green color is due to $[(\text{H}_2\text{O})_5\text{CrI}]^{2+}$ which is unstable and changes to $[\text{Cr}(\text{H}_2\text{O})_6]^{3+} + \text{I}^-$. He assumed that this was due to the formation of a Cr-I bond before Cr(II) was oxidized by I_2 . Subsequently, he performed another test tube experiment using $[(\text{NH}_3)_5\text{CoCl}]^{2+}$ as an oxidant and found that $\text{Cr}^{2+}(\text{aq})$ was converted into $[\text{Cr}(\text{H}_2\text{O})_6]^{3+}$ via green $[(\text{H}_2\text{O})_5\text{CrCl}]^{2+}$. This reaction established the inner-sphere electron transfer mechanism in which a Co-Cl-Cr bridge forms between Co^{3+} and Cr^{2+} and led to the Nobel Prize in a later year.

(b) Redox reactions

The oxidation number of the central metal in a transition-metal compound can vary in a few steps from low to high. Namely, the oxidation state of a compound is changeable by redox reactions. As a consequence of this, the bond distance and the bond angle between the metal and coordinating elements, or between metals, change, and at times the whole structure of a complex can be distorted remarkably or the compound may even decompose.

The reactions of a metal compound with various reducing or oxidizing agents are also very important from the viewpoint of synthetic chemistry. Especially, reduction reactions are used in the preparation of organometallic compounds, such as metal carbonyls or cluster compounds.

Meanwhile, the study of electron transfer between complexes, especially the redox reactions of transition metal complexes, has developed. Taube won the Nobel Prize (1983) for the study of electron transfer reactions in transition metal complexes, classifying such reactions into two mechanisms. The mechanism of electron transfer in which a bridging ligand is shared between two metals is called the **inner-sphere mechanism**, and the one involving a direct transfer of electrons between two metals without a bridging ligand is called the **outer-sphere mechanism**.

Inner-sphere mechanism When $[\text{CoCl}(\text{NH}_3)_5]^{2+}$ is reduced by $[\text{Cr}(\text{OH}_2)_6]^{2+}$, an intermediate complex, $[(\text{NH}_3)_5\text{Co}-\text{Cl}-\text{Cr}(\text{OH}_2)_5]^{4+}$, is formed in which the chlorine atom forms a bridge between cobalt and chromium. As a result of an electron transfer from chromium to cobalt through chlorine, $[\text{Co}(\text{NH}_3)_5\text{Cl}]^+$, in which cobalt is reduced from a trivalent to a divalent oxidation state and $[\text{Cr}(\text{OH}_2)_6]^{3+}$, in which chromium is oxidized from a divalent to a trivalent oxidation state, are formed. This kind of reaction is a redox reaction via the inner-sphere mechanism. The anions other than halogens suitable for such bridge formation are SCN^- , N_3^- , CN^- , etc. .

Outer-sphere mechanism When $[\text{Fe}(\text{phen})_3]^{3+}$ (phen is orthophenanthroline) is reduced by $[\text{Fe}(\text{CN})_6]^{4-}$, no ligand bridge forms between the metals and an electron moves from the HOMO of Fe(II) to the LUMO of Fe(III) in a very short and direct contact between the two complexes. As the result of the electron transfer, $[\text{Fe}(\text{phen})_3]^{2+}$ and $[\text{Fe}(\text{CN})_6]^{3-}$ form. This kind of reaction is a redox one via the outer-sphere mechanism, and is characteristic of a complex system that has a very slow ligand substitution rate compared with the speed of electron transfer, especially in systems that have the same ligands but different oxidation-numbers, for example, $[\text{Fe}(\text{CN})_6]^{3-} - [\text{Fe}(\text{CN})_6]^{4-}$ has a high rate of electron transfer. R. A. Marcus won the Nobel Prize (1992) for his study of this outer-sphere electron transfer mechanism.

Problem

- 6.1 Which cavity, either the octahedral or tetrahedral one, in an array of oxygen atoms do Fe^{2+} ions tend to occupy in iron oxide Fe_3O_4 containing both Fe^{2+} and Fe^{3+} ions?
- 6.2 Describe a method of preparing *trans*- $[\text{PtCl}(\text{Et})(\text{PEt}_3)_2]$.
- 6.3 Propose mononuclear and dinuclear metal complexes containing cyclopentadienyl and carbonyl ligands that satisfy the 18-electron rule.
- 6.4 Devise a method of selective syntheses of *cis*- $[\text{PtCl}_2(\text{NH}_3)_2]$ and *trans*- $[\text{PtCl}_2(\text{NH}_3)_2]$ using the trans effect.
- 6.5 How can it be proven that the reduction reaction of $[\text{CoCl}(\text{NH}_3)_5]^{2+}$ by $[\text{Cr}(\text{OH}_2)_6]^{2+}$ proceeds by the inner-sphere electron transfer mechanism?

7 Lanthanoids and Actinoids

Lanthanoids and actinoids are *f*-block transition elements, but their general properties differ significantly from those of *d*-block transition metals. These elements are placed in separate positions in the periodic table showing that the periodicity of their electronic structures differs from the main stream. Although lanthanoids are called rare-earth elements, their abundance in the crust is by no means rare and chemistry utilizing their unique properties is likely to develop significantly in the near future. Actinoids are closely related to nuclear chemistry and nuclear energy. Since the amount of superheavy elements "synthesized" in accelerators is very minute, they are not very significant from the viewpoint of applied chemistry.

7.1 Lanthanoids

The fifteen elements shown in Table 7.1 from lanthanum, La ($4f^0$), to lutetium, Lu ($4f^{14}$), are **lanthanoids**. Ln may be used as a general symbol for the lanthanoid elements. Although lanthanoids, scandium, Sc, and yttrium, Y, are sometimes called rare earth elements, they are relatively abundant in the earth's crust. With the exception of promethium, Pm, which does not form a stable isotope, even the least abundant thulium, Tm, and lutetium, Lu, are as abundant as iodine. Because lanthanoids have very similar properties and are difficult to separate from one another, they were not useful for basic research and application, and hence they were regarded as rare elements. Since a liquid-liquid solvent extraction method using tributylphosphine oxide became available in the 1960s, lanthanoid elements have been readily available and widely used not only for chemical research but also as materials in alloys, catalysts, lasers, cathode-ray tubes, *etc.*

Exercise 7.1 What is the difference between lanthanoids and lanthanides?

“Answer” Fifteen elements La-Lu are lanthanoids and fourteen elements Ce-Lu without lanthanum are lanthanides (meaning the elements similar to lanthanum). Occasionally the names are confused and 15 elements including lanthanum may be called lanthanides.

Table 7.1 Properties of lanthanoids

Atomic number	Name	Symbol	Electron configuration	M ³⁺ radius (pm)
57	Lanthanum	La	5d ¹ 6s ²	116
58	Cerium	Ce	4f ¹ 5d ¹ 6s ²	114
59	Praseodymium	Pr	4f ³ 6s ²	113
60	Neodymium	Nd	4f ⁴ 6s ²	111
61	Promethium	Pm	4f ⁵ 6s ²	109
62	Samarium	Sm	4f ⁶ 6s ²	108
63	Europium	Eu	4f ⁷ 6s ²	107
64	Gadolinium	Gd	4f ⁷ 5d ¹ 6s ²	105
65	Terbium	Tb	4f ⁹ 6s ²	104
66	Dysprosium	Dy	4f ¹⁰ 6s ²	103
67	Holmium	Ho	4f ¹¹ 6s ²	102
68	Erbium	Er	4f ¹² 6s ²	100
69	Thulium	Tm	4f ¹³ 6s ²	99
70	Ytterbium	Yb	4f ¹⁴ 6s ²	99
71	Lutetium	Lu	4f ¹⁴ 5d ¹ 6s ²	98

Because the three stages of ionization enthalpy of lanthanoid elements are comparatively low, they are positive elements and readily assume trivalent ionic states. Most compounds of lanthanoids other than Ce⁴⁺ (4f⁰), Eu²⁺ (4f⁷), Yb²⁺ (4f¹⁴), are usually Ln³⁺ ones. Ln³⁺ species are hard acids, and since *f* electrons are buried deeply and not used for bonding, they are hardly influenced by ligands. There is a tendency for atomic and ionic radii to decrease with the increase of the atomic number, and this phenomenon is called the **lanthanide contraction**. This contraction is due to small shielding effects of 4*f* electrons, which causes the atomic nucleus to draw outer shell electrons strongly with an increase of atomic number.

Complexes of lanthanoid metals are 6 to 12 coordinate and especially many 8 and 9 coordinate compounds are known. Organometallic compounds with cyclopentadienyl ligands of the types Cp₃Ln or Cp₂LnX are also known, all of which are very reactive to oxygen or water.

7.2 Actinoids

The fifteen elements from actinium, Ac, to lawrencium, Lr, are called **actinoids** (Table 7.2). The general symbol of these elements is An. All the actinoid elements are radioactive and very poisonous. Actinoids that exist in nature in considerable amounts are thorium, Th, protactinium, Pa, and uranium, U, and thorium and uranium are actually isolated from ores and find application. Plutonium metal, Pu, is produced in large quantities in nuclear reactors and its economical efficiency as a fuel for conventional

nuclear reactors and fast breeder reactors, as well as its safety, are being examined. As isolable amounts of the elements after americium, Am, are small and their radioactivity is very high, study of their chemical properties is very limited.

Table 7.2 Properties of actinoids

Atomic number	Name	Symbol	Electron configuration	M ³⁺ radius (pm)	Main isotope
89	Actinium	Ac	6d ¹ 7s ²	126	²²⁷ Ac
90	Thorium	Th	6d ² 7s ²		²³² Th
91	Protactinium	Pa	5f ² 6d ¹ 7s ²	118	²³¹ Pa
92	Uranium	U	5f ³ 6d ¹ 7s ²	117	²³⁵ U, ²³⁸ U
93	Neptunium	Np	5f ⁵ 7s ²	115	²³⁷ Np
94	Plutonium	Pu	5f ⁶ 7s ²	114	²³⁸ Pu, ²³⁹ Pu
95	Americium	Am	5f ⁷ 7s ²	112	²⁴¹ Am, ²⁴³ Am
96	Curium	Cm	5f ⁷ 6d ¹ 7s ²	111	²⁴² Cm, ²⁴⁴ Cm
97	Berkelium	Bk	5f ⁹ 7s ²	110	²⁴⁹ Bk
98	Californium	Cf	5f ¹⁰ 7s ²	109	²⁵² Cf
99	Einsteinium	Es	5f ¹¹ 7s ²		
100	Fermium	Fm	5f ¹² 7s ²		
101	Mendelevium	Md	5f ¹³ 7s ²		
102	Nobelium	No	5f ¹⁴ 7s ²		
103	Lawrencium	Lr	5f ¹⁴ 6d ¹ 7s ²		

The process of radioactive disintegration of radioactive elements into stable isotopes is of fundamental importance in nuclear chemistry. If the amount of a radionuclide which exists at a certain time is N , the amount of disintegration in unit time is proportional to N . Therefore, radioactivity is

$$-\frac{dN}{dt} = \lambda N$$

(λ is disintegration constant)

integration of the equation leads to

$$N = N_0 e^{-\lambda t}$$

where N_0 is the number of atoms at zero time and the time during which the radioactivity becomes half of N_0 is the **half life**.

$$T = \frac{\ln 2}{\lambda} = \frac{0.69315}{\lambda}$$

Exercise 7.2 How does a nuclide change with α disintegration and β^- disintegration?

“Answer” Because an atomic nucleus of helium atom, ${}^4\text{He}$, is emitted by α disintegration of a nuclide, its atomic number Z becomes $(Z-2)$ and its mass number A changes to $(A-4)$. In β^- disintegration, an electron is emitted and Z becomes a nuclide $(Z+1)$.

Isolation of thulium

Thulium is a rare earth element with the least abundance except promethium, and there were remarkable difficulties in isolating it as a pure metal. P. T. Cleve discovered the element in 1879, but it was only 1911 when the isolation of the metal of almost satisfying purity was reported.

C. James of the United States tried many minerals and found that three ores, ytterspar, euzenite and columbite produced from an island in the northern Norway, were the best source. In order to obtain a purer metal of thulium, chromates of the mixed rare-earth metals obtained by the treatment of a large amount of the ores by sodium hydroxide, hydrochloric acid, oxalic acid, and barium chromate were recrystallized repeatedly from water and water-alcohol. In those days, identification of an element by spectroscopy was already possible, and recrystallizations were repeated 15,000 times over several months, proving that it was not possible to obtain purer metal.

Chemists are requested to repeat monotonous operations even now but it is not likely that patience of this sort still exists. This may hinder the progress of our understanding of the chemistry of rare earth elements.

Although actinoids are similar to lanthanoids in that their electrons fill the $5f$ orbitals in order, their chemical properties are not uniform and each element has characteristic properties. Promotion of $5f$ - $6d$ electrons does not require a large amount of energy and examples of compounds with π -acid ligands are known in which all the $5f$, $6d$, $7s$, and $7p$ orbitals participate in bonding. Trivalent compounds are the most common, but other oxidation states are not uncommon. Especially thorium, protactinium, uranium,

and neptunium tend to assume the +4 or higher oxidation state. Because their radioactivity level is low, thorium and uranium, which are found as minerals, can be handled legally in a normal laboratory. Compounds such as ThO_2 , ThCl_4 , UO_2 , UCl_3 , UCl_4 , UCl_6 , UF_6 , *etc.* find frequent use. Especially uranium hexafluoride, UF_6 , is sublimable and suitable for gas diffusion and undergoes a gas centrifuge process for the separation of ^{235}U . Thorium is an oxophilic element similar to the lanthanoids.

Problem

7.1 What is the reason for the relatively easy separation of cerium and europium among the lanthanoids, which were difficult to isolate?

7.2 Calculate the radioactivity after a period of 10 times as long as the half-life of a given material.

8 Reaction and Physical Properties

Organic synthesis using complexes and organometallic compounds, homogeneous catalysis, bioinorganic chemistry to elucidate biological reactions in which metals participate, and studying solid state properties such as solid state catalysis, conductivity, magnetism, optical properties are all important fields of applied inorganic chemistry. Basic inorganic chemistry, although previously less developed compared with organic chemistry, is now making fast progress and covers all elements. Construction of general theories of bonding, structure, and reaction covering molecules and solids is a major problem for the near future.

8.1 Catalytic reactions

Catalysts reduce the activation energy of reactions and enhance the rate of specific reactions. Therefore they are crucially important in chemical industry, exhaust gas treatment and other chemical reactions. While the chemical essence of **catalysis** is obscure, practical catalysts have been developed based on the accumulation of empirical knowledge. However, while gradually we have come to understand the mechanisms of homogeneous catalysis through the development of inorganic chemistry, our understanding of surface reactions in solid catalysts is also deepening.

(a) Homogeneous catalysis

The chemistry of catalysts that are soluble in solvents has developed remarkably since the epoch-making discovery (1965) of the **Wilkinson catalyst**, $[\text{RhCl}(\text{PPh}_3)_3]$. This complex is a purplish red compound which forms by heating $\text{RhCl}_3 \cdot 3\text{H}_2\text{O}$ and PPh_3 under reflux in ethanol. When dissolved in an organic solvent, this complex is an excellent catalyst for **hydrogenation** of unsaturated hydrocarbons by H_2 at ambient temperatures and pressures to form saturated hydrocarbons, and **hydroformylation** reactions of olefins with H_2 and CO to form aldehydes.

In the past, the mechanism of catalytic reactions were generally not very clear. Before the Wilkinson catalyst, the **Reppé process**, which oligomerize acetylenes or the **Ziegler-Natta catalysts** that polymerize olefins and dienes, had been discovered and detailed studies on **homogeneous catalysis** had been conducted from the viewpoint of the chemistry of complexes. Consequently, catalytic reactions are now established as a cycle

of a combination of a few elementary steps that occur on the metals of catalyst complexes.

Coordination and dissociation There must be a process in which reactants such as olefins are activated and react with other reactants after being coordinated to the central metal of a complex, and they dissociate from the metal as products.

Oxidative addition Oxidative addition is one among a few key elementary reactions of metal complexes. This is a reaction of such compounds as alkali metal halides, RX, acids, HX or dihydrogen, H₂, to the metal in a complex which then dissociate into R and X, H and X, or H and H, which are bonded to the metal as two fragment anions. If other ligands on the start complex are not removed, the coordination number increases by two. As alkyl, halogen, and hydride ligands are more electronegative than the central metal, they are regarded as formally anionic ligands after coordination. Therefore, the oxidation number of the central metal increases after an addition reaction. As it is an addition reaction accompanied by oxidation of the central metal, it is called oxidative addition.

For example, in the addition reaction of an alkyl halide to a tetra-coordinate iridium(I) complex [IrCl(CO)(PPh₃)₂],

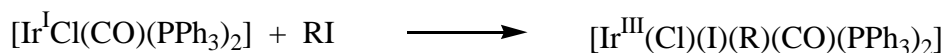

iridium becomes hexa-coordinate and undergoes two-electron oxidation from +1 to +3. Since a neutral RI molecule is added, there must be no change in the charge of the whole complex, and if an alkyl and iodine are anions, the oxidation number of the central metal should increase by 2. Similar change occur when two hydride ligands are formed as the result of the addition of dihydrogen.

The reverse reaction is called **reductive elimination**. Both oxidative and reductive reactions are very important as elementary steps in the mechanism of homogeneous catalysis involving hydrocarbons and dihydrogen.

Exercise 8.1 How does the oxidation number of rhodium change with reductive elimination of dihydrogen from [RhCl(H)₂(PPh₃)₂ (Sol)]?

“Answer” It changes to Rh(I) from Rh(III).

Insertion reaction In the reaction of an alkyl or hydride ligand to shift to a carbonyl or olefin ligand coexisting on the central metal, the resultant complex appears as

if a carbonyl or an olefin has inserted between the M-R or M-H bond. This is called an insertion reaction.

Reaction of a coordinated ligand This is the process in which a coordinated reactant reacts to form a product. By coordinating to a metal, the reactants take geometrically and electronically suitable conformations. It is the basis of catalyst design to control these reaction conditions.

Since a reaction is repeated while the complex used as a catalyst remains unchanged by forming a cycle of reactions, the reactants/complex ratio is very small, co-inciding with the definition of a catalyst. The catalytic cycle in hydrogenation of ethylene is illustrated in Fig. 8.1.

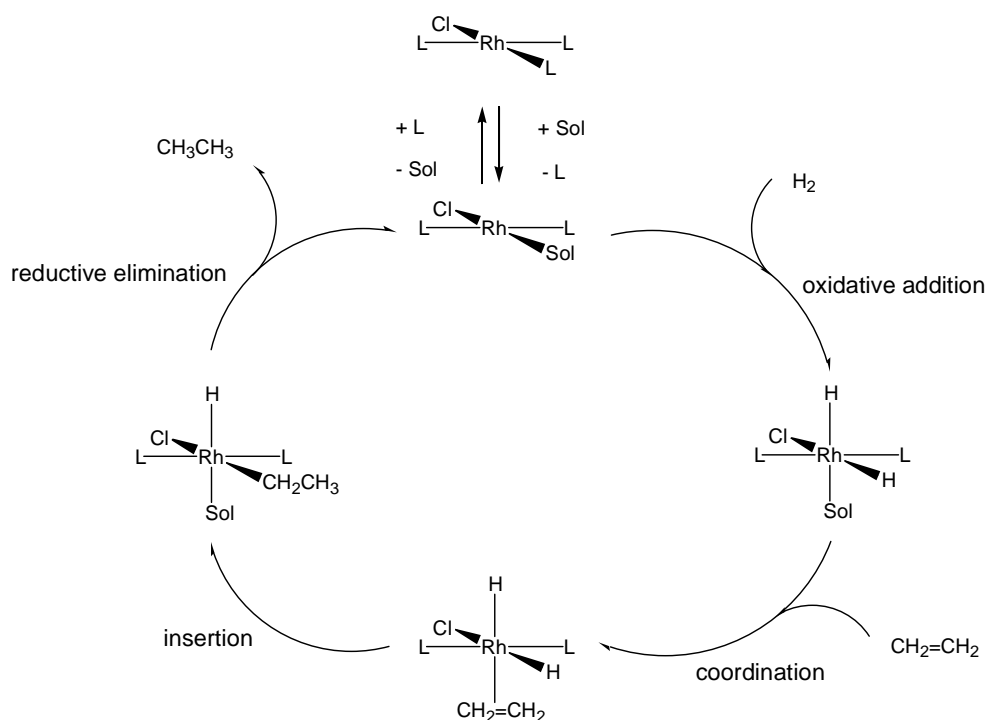

Figure 8.1 Catalytic cycle of ethylene hydrogenation by the Wilkinson catalyst. L is a ligand and Sol is a solvent molecule.

If the triphenylphosphine ligand $\text{P}(\text{C}_6\text{H}_5)_3$ in the Wilkinson catalyst is replaced by an optical active phosphine, **asymmetric hydrogenation** is realized. Asymmetrical catalysis equivalent to enzyme reactions have been developed by skillful design of asymmetrical ligands. In particular, the asymmetric induction of binaphtyldiphosphine (BINAP) has attracted attention.

(b) Solid state catalysis

A solid catalyst is also called a **heterogeneous catalyst**, and promotes the reaction of reactants in gaseous or liquid phases in contact with a solid material. Since adsorption of reactants on the catalyst surface is the initial step, a large surface area is required for good efficiency of catalysis. Polyphase systems, which carry active catalysts on materials such as zeolites with small pores of molecular sizes, and gamma alumina and silica gel with large surface area, are often used.

Previously, solid state catalysis was explained as arising from a mysterious activation of reactants due to adsorption, but it has become increasingly clear that catalysis is ascribable to surface chemical reactions. Namely, the action of solid state catalysts depends on activation of reactants by surface acids or bases, and by coordination to the metal surface. It is possible to observe these interactions using various spectroscopies (infrared spectroscopy, EXAFS (extended X-ray absorption fine structure), electronic spectra), electron microscopy, or STM (scanning tunnelling microscopy).

Since mechanisms of homogeneous catalysis have been clarified considerably, solid surface reactions can also be analyzed by introducing concepts such as “surface complexes” or “surface organometallic compounds”. However, unlike homogeneous catalysis, in which only one or a few metal centers participate, many active sites are involved in solid state catalysis. Since surface homogeneity and reproducibility are difficult to maintain, major parts of reaction mechanisms are obscure even for such simple reactions as ammonia synthesis.

During the direct production of ammonia from dinitrogen and dihydrogen, reactions occur using iron catalysts containing alkali metal or alkaline earth metal oxides as activators at high temperatures (about 450 °C) and under high pressures (about 270 atm). Prior to the epoch-making discovery of this process by F. Haber (1909), all nitrogen compounds came from natural resources. The realization of this discovery has had an immeasurable influence upon chemical industries, as ammonia is indispensable to the manufacture of fertilizers, gunpowder and other inorganic compounds containing nitrogen. In recognition of this, a Nobel Prize was awarded to F. Haber for this invention (1918). A huge volume of research on the elucidation of the reaction mechanism of ammonia synthesis has been performed up until the present, because the reaction of dinitrogen and dihydrogen on iron catalysts is a good model of solid state catalysis.

8.2 Bioinorganic chemistry

Many biological reactions are known to involve metal ions. There are also metals recognized as essential elements, although their roles in living organisms are not clear. Bioinorganic chemistry, the study of the functions of metals in biological systems using the knowledge and methods of inorganic chemistry, has progressed remarkably in recent years.

The following list shows typical bioactive substances containing metals.

- (1) Electron carriers. Fe : cytochrome, iron-sulfur protein. Cu : blue copper protein.
- (2) Metal storage compound. Fe : ferritin, transferrin. Zn : metallothionein.
- (3) Oxygen transportation agent. Fe: hemoglobin, myoglobin. Cu: hemocyanin.
- (4) Photosynthesis. Mg: chlorophyll.
- (5) Hydrolase. Zn: carboxypeptidase. Mg: aminopeptidase.
- (6) Oxidoreductase. Fe: oxygenase, hydrogenase. Fe, Mo: nitrogenase.
- (7) Isomerase. Fe: aconitase. Co: vitamin B₁₂ coenzyme.

The basis of chemical reactions of metalloenzymes are

- (1) Coordinative activation (coordination form, electronic donating, steric effect),
- (2) Redox (metal oxidation state),
- (3) Information communication,

and, in many cases, reaction environments are regulated by biopolymers such as proteins, and selective reactions are performed.

Examples of actions of metals other than by metalloenzymes include

- (1) Mg: MgATP energy transfer,
- (2) Na/K ion pumping,
- (3) Ca : transfer of hormone functions, muscle contraction, nerve transfer, blood coagulation, are some of the important roles of metals.

(a) Oxidation

Oxidation reactions in living systems are fundamental to life, and many studies of these systems have been performed. In particular, the mechanisms of oxygen gas transportation by hemoglobin and mono-oxygen oxidation by the iron porphyrin compounds named P-450 have been studied at length. Oxygen gas transportation, which has been studied for many years, is described below. Iron porphyrins hemoglobin and myoglobin and the copper compound hemocyanin are involved in the transportation of oxygen gas in air to cells in living organisms. The basis of this function is reversible bonding and dissociation of dioxygen to iron or copper ions. In order to perform these functions, metals must be in oxidation states and coordination environments suitable for

the reversible coordination of dioxygen. The iron porphyrin compound hemoglobin is found in red bloods of human beings and other animals.

Hemoglobin has the structure of heme iron with four iron porphyrin units combined with a globin protein. Dioxygen is transported in blood by being coordinated to ferrous ions in the hem iron unit. The Fe (II) ion is penta-coordinate with four nitrogen atoms of porphyrin and a nitrogen atom of the polypeptide histidine, and becomes hexa-coordinate when a dioxygen coordinates to it. The spin state of Fe (II) changes from high spin to low spin upon the coordination of dioxygen. The high spin Fe(II) is above the plane of porphyrin because it is too large to fit in the available space. When the Fe(II) ion becomes low spin upon dioxygen coordination, the size of the iron ion decreases and it just fits into the hole of the porphyrin molecule.

This molecular-level movement has attracted interest as an **allosteric effect** because it affects the whole protein through the histidine coordinate bond and governs the specific bond of a dioxygen molecule. Oxidation of the Fe(II) ion of a hem molecule is prevented by a macromolecular protein, and if the hem iron is taken out of the protein, Fe(II) ion is oxidized to Fe(III), and two porphyrin rings are bridged by a peroxide $\mu\text{-O}_2^{2-}$, which finally changes to a bridging $\mu\text{-O}_2$ -structure.

When the hem is in this state, it loses the ability to coordinate to the dioxygen molecule. Based on this phenomenon, a synthetic porphyrin that is able reversibly to coordinate to a dioxygen by suppressing dimerization of the iron porphyrin has been developed, and was named the **picket fence porphyrin** after its three dimensional form.

(b) Nitrogen fixation

The reaction which converts the nitrogen in air into ammonia is basic to all life. **Nitrogen fixation**, the reaction to fix atmospheric nitrogen to form ammonia, is carried out by *Rhizobium* in the roots of legumes or by bacteria in algae in an anaerobic atmosphere. All animals and plants, including mankind, were depended on biological nitrogen fixation as a source of nitrogen for protein and other compounds containing nitrogen before the invention of the Harber-Bosch process.

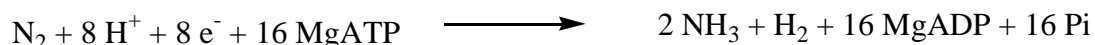

(where Pi is an inorganic phosphate)

An enzyme named **nitrogenase** catalyzes this reaction. Nitrogenase contains iron-sulfur and iron-molybdenum sulfur proteins, and reduces dinitrogen by coordination

and cooperative proton and electron transfers, while using MgATP as an energy source. Because of the importance of this reaction, attempts to clarify the structure of nitrogenase and to develop artificial catalysts for nitrogen fixation have continued for many years. Recently, the structure of an active center in nitrogenase called iron-molybdenum cofactor was clarified by single crystal X-ray analysis (Fig. 8.2). According to this analysis, its structure has Fe_3MoS_4 and Fe_4S_4 clusters connected through S.

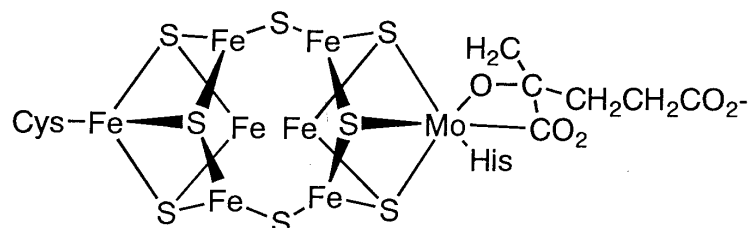

Figure 8.2 Structure of Fe-Mo cofactor in nitrogenase.

It is believed that dinitrogen is activated by coordination between the two clusters. On the other hand, the portion called P cluster consists of two Fe_4S_4 clusters. The roles and reaction mechanism of both parts are not yet clear.

(c) Photosynthesis

The formation of glucose and dioxygen by the reaction of carbon dioxide and water is a skillful reaction using photoenergy and in which chlorophyll (Fig. 8.3), which is a magnesium porphyrin and a manganese cluster complex, plays the central role. A chloroplast contains photosystem I (PSI) and photosystem II (PSII), which use light energy to reduce carbon dioxide and to oxidize water.

Chlorophyll is a fundamental component of PSI. Chlorophyll is a porphyrin complex of magnesium and is responsible for the green colors of leaves. It plays an important role in receiving light energy and transferring it to redox reaction systems. Chlorophyll is excited from the singlet ground state to the singlet excited state by light, the energy of the excited state is transferred to an acceptor within 10 ps, and the resultant energy reduces an iron-sulfur complex and is finally used for reduction of carbon dioxide in subsequent dark reactions. Since charge separation by photochemical excitation is the most important first stage, studies on photoinduced electron transfer are have been actively performed using various kinds of porphyrin compounds as models of chlorophylls. PSI, which obtains oxidizing energy by electron transfer, converts ADP to ATP.

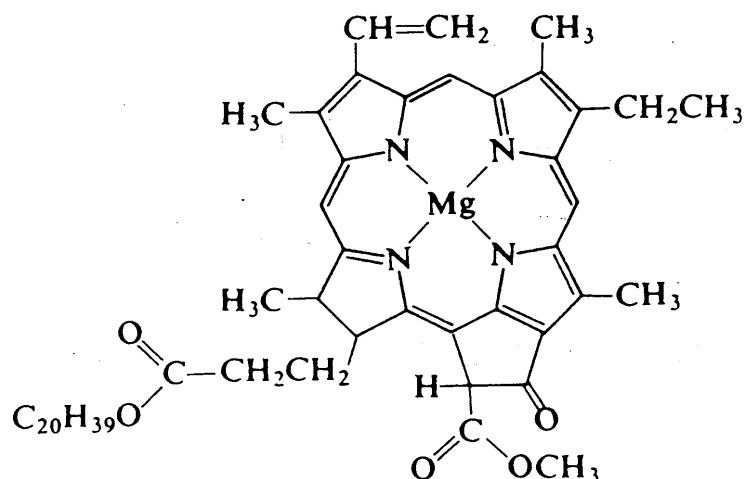

Figure 8.3 Chlorophyll *a*.

On the other hand, the oxidized form of PSII oxidizes water through a chain of redox reactions of oxo cluster complexes of manganese, and generates oxygen. Since four electrons shift in the reduction of Mn(IV) to Mn(II) in this reaction, at least two manganese species are involved. Probably, a cluster complex which contains two Mn(II) and two Mn(IV) species mediates the electron transfer via four step reactions. However, the details of this reaction are as yet unclear because it is very difficult to isolate this cluster and to analyze its structure. The electron transfer stage is being studied at present by using various manganese complexes as model systems.

Photosynthesis is a very interesting research theme in bioinorganic chemistry as it involves a few metal ions, a porphyrin, sulfide and oxide clusters that constitute a cycle of subtle electron transfer and redox reactions, and generate oxygen gas by photolysis of water and produce carbohydrates from carbon dioxide by reductive dark reactions. Recently, the reaction center of a photosynthetic bacteria was crystallized and J. Deisenhofer and his colleagues won a Nobel prize for its structural analysis (1988).

Exercise 8.2 Give examples of small molecules that are fundamentally important for living things.

“Answer” H₂O, O₂, N₂, CO₂.

8.3 Physical properties

It is barely imaginable that materials based on the physical properties of solid inorganic compounds have played such decisive roles in present-day technology and industry. One may think that this field belongs more to material physics. However, apart

from the theories of physical properties, the contribution of chemistry and chemists to the preparation of materials and their structural analysis has been greater than that of other branches of science. Material science is the application of the fundamental physical properties of materials such that basic theories and their applications converge. Therefore, by surveying the applications in such fields, the outlines of research themes and their purposes can be understood.

Important inorganic materials are surveyed from the chemical point of view by focusing on the relationship between preparation and isolation, and structure and physical properties.

(a) Electric properties

A semiconductor is an electrical conductor with electrical resistance in the range of about 10^4 to 10^8 ohms. A typical semiconductor is a super-high grade silicon that is manufactured on a large scale and is widely used for information processing devices such as computers and energy conversion devices such as solar cells. VLSI (very large-scale integrated circuits) are printed on wafers made from almost defectless silicon single crystals with diameters of no less than 20 cm, prepared from polycrystalline silicon by the Czochralski method. Memory chips with a very high degree of integration as well as highly efficient computer chips have recently been realized.

In a short periodic table, silicon is a group IV element and has four valence-electrons. Although silicon semiconductors currently represent 90% or more of all semiconductors, isoelectronic 1:1 compounds of II-VI or III-V groups form compound semiconductors and are also used for optical or ultra high-speed electronic devices. For example, ZnS, CdS, GaAs, InP, *etc.* are typical compound semiconductors and the development of technologies to grow single crystals of these materials is remarkable. Light emitting diodes (LED) or semiconductor lasers are important applications of compound semiconductors.

As thin films of compound semiconductors are made by MBE (molecular beam epitaxy) or MOCVD (metallorganic chemical vapor deposition), special organometallic compounds, such as trimethyl gallium $\text{Ga}(\text{CH}_3)_3$ and trimethylarsenic $\text{As}(\text{CH}_3)_3$, which previously found little application, are now used industrially.

Exercise 8.3 What compounds other than the examples given are suitable as semiconductors?

“Answer” ZnO, CdS, PbS, GaP, and InSb

Superconductivity is a phenomenon of zero electrical resistance below a critical

temperature, T_c , and was discovered in 1911 by Kamerlingh Onnes (1913 Nobel Prize for physics), who succeeded in liquefying helium during his experiments to measure the electrical resistance of mercury at ultra low temperatures. About 1/4 of the elements, such as Nb ($T_c = 9.25$ K), In, Sn, and Pb behave as superconductors and more than 1000 alloys and intermetallic compounds are also superconductors, but only Nb-Ti alloy ($T_c = 9.5$ K) and Nb₃Sn ($T_c = 18$ K) find application. Nb₃Sn, Nb₃Ge, V₃Ga, *etc.*, are cubic A-15 type compounds, in which transition metal atoms are aligned in chains, and interatomic distances are shorter than those in the crystalline bulk metal, raising the density of states of the conduction band and the critical temperature, T_c , of the compound.

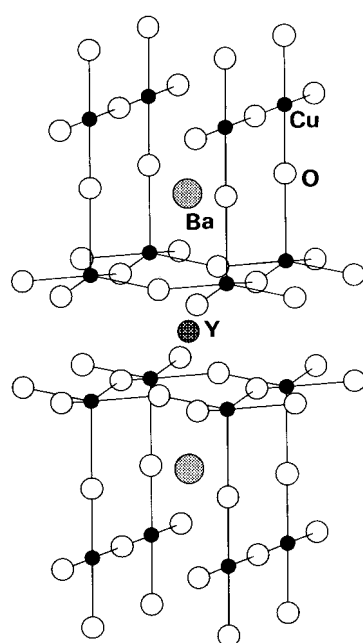

Figure 8.4 Structure of YBa₂Cu₃O_{7-x}.

Among inorganic compound superconductors, chalcogenide compounds M_xMo₆X₈ (X = S, Se, Te, and M = Pb, Sn, *etc.*) of molybdenum called **Chevrel phases** and high-temperature superconductors of copper oxide derivatives, which J. G. Bednorz and K. A. Müller discovered in 1986 (1987 Nobel Prize for physics), have attracted attention. Chevrel phases have structures (refer to Section 4.4) in which hexanuclear cluster units of molybdenum are joined and the highest T_c is only 15 K of PbMo₆S₈, but the superconductive state is not broken even in strong magnetic fields. In the copper oxide system, more than 100 similar compounds have been prepared since the first discovery and the highest T_c so far discovered is 134 K. A typical compound, YBa₂Cu₃O_{7-x}, has a structure (Fig. 8.4) in which CuO₅ square pyramids and CuO₄ planes are connected by

corner-sharing, Ba and Y are inserted between them, and the oxygen content is non-stoichiometric.

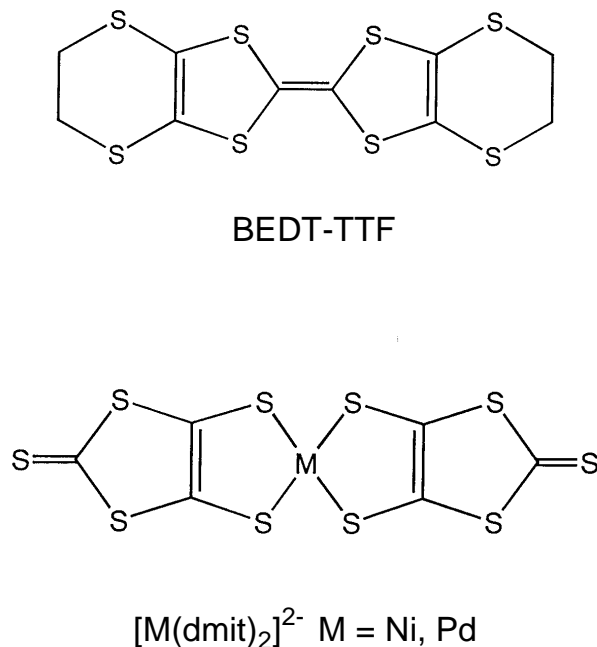

Figure 8.5 An electron donor and acceptor in a complex superconductor.

On the other hand, molecular superconductors have also been studied. Representative donor-acceptor complexes are composed of TTF and BEDT-TTF (Fig. 8.5) as electron donors, and ClO_4^- or $[\text{Ni}(\text{dmit})_2]^{2-}$ as electron acceptors. The first example of this kind of superconductor was discovered in 1980, and of the about 50 complexes known at present, the highest T_c is 13K. Recently (1991) fullerene C_{60} doped with alkali metals showed a T_c of about 30K.

Although thousands of superconductors are known, only a few of them find application. Because compound superconductors are very brittle; either it is difficult to make them into wires or only small single crystals are obtained. It will take considerable time before some of them find practical use. Therefore, mainly Nb-Ti wires are used as the superconducting magnets of analytical NMR, medical MRI (magnetic resonance imaging instrument) or maglev trains, *etc.* Efforts are concentrated on discovering materials that have suitable mechanical and other properties by cooperation between inorganic chemistry and solid-state physics.

Various metal oxides are used as thermistors (temperature sensitive resistance

device), varistors (nonlinear resistance device), capacitors, *etc.* For example, BaTiO₃, with a perovskite structure, and SrTiO₃, *etc.* can be used for any of the above-mentioned purposes. Ionic conduction materials are also called solid electrolytes and α -AgI, β -Al₂O₃, stabilized zirconia (a part of Zr in ZrO₂ is replaced by Ca or Y), *etc.* are used in solid state batteries or fuel cells.

(b) Magnetism

Magnetic materials are divided into hard (permanent magnets) and soft magnetic materials. Permanent magnets are indispensable to machines using motors and MRI, which requires a high magnetic field. Japan has a strong tradition in the development of magnets, and has made many epoch-making magnetic materials for practical use. Alnico magnets with Fe, Ni, and Al as their main constituents, ferrite magnets composed of solid solutions of CoFe₂O₄ and Fe₃O₄, cobalt-rare earth magnets such as SmCo₅, and Nb-Fe-B magnets were especially significant achievements. Since soft magnetic materials are strongly magnetized in weak magnetic fields, they are most suitable for use as core materials in transformers. Hard magnetic properties are necessary for the stable maintenance of information whereas soft magnetic properties are required for recording and over-writing information in magnetic recording materials such as magnetic tapes, floppy disks, and hard disks. Although γ -Fe₂O₃ is a typical magnetic powder used for these purposes, Co⁺ or crystalline CrO₂ is added to it to improve its magnetic properties. Recording materials as well as semiconductor devices are indispensable to our modern information-oriented society, and the role played by inorganic chemistry in the improvement of the performance of these materials is significant. Recently, ferromagnetism of organic compounds or metal complexes has been discovered, in which unpaired spins are aligned parallel in a molecule and coupled ferromagnetically. The study of molecular magnets has the subject of intensive investigation. Molecular design to couple paramagnetic metal complexes and to make spins parallel is an interesting subject in coordination chemistry.

(c) Optical properties

Mainly inorganic substances are used as materials for optical applications. The optical fiber in particular has been used for optical communications on a large scale, and has had a major social influence in information communication. A necessary property of good optical glass materials is the transmission of information to distant places with little optical loss. Silica fibers are manufactured by lengthening silica glass rods produced from silica grains. The silica is made from ultra pure SiCl₄, which is oxidized in the vapor phase by an oxyhydrogen flame. As the optical loss along fibers obtained by this method

has already reached its theoretical limit, fluoride glasses are being used in the search for materials with lower levels of loss.

Compound semiconductors such as GaP are widely used as laser light emitting diodes for optical communications, CD players, laser printers, *etc.* A high output YAG laser is made from neodymium-doped yttrium aluminum garnet, $\text{Y}_3\text{Al}_5\text{O}_{12}$, which is a double oxide of Y_2O_3 and Al_2O_3 . Single crystals, such as lithium niobate, LiNbO_3 , are used for changing wavelength of light by means of SHG (second harmonic generation) of nonlinear optics phenomena.

Problem

- 8.1 Write a catalytic reaction cycle of the hydroformylation reaction which uses $[\text{RhH}(\text{CO})(\text{PPh}_3)_3]$ as a catalyst.
- 8.2 Describe differences between ammonia synthesis by the Harber-Bosch process and biological nitrogen fixation reactions.
- 8.3 A-15 type intermetallic compounds such as Nb_3Sn are cubic crystals with the A_3B composition . Consider how to locate each atom in such a unit cell.

Structure-function correlation

Since all the naturally occurring elements have been discovered, various bonding modes are established and the structures of compounds can be readily determined, studies of the chemical properties of inorganic compounds will give way to studies of reactions and physical properties. The synthesis of new compounds and the elucidation of structure-function correlations will be the foundations of these studies, although the end is distant.

It is considerably difficult quantitatively to explain the thermal stability of a known inorganic compound using our present knowledge of theoretical chemistry and it is almost impossible fully to design compounds by a rational method. Although the selectivity of a catalytic reaction can be explained to some extent, the theoretical calculation of a reaction rate remains difficult. The relation between superconductivity and structure is not understood well, and critical temperatures cannot be predicted. Many of the structures and functions of the metalloenzymes that are the basis of biological activities are unknown. The research problems confronting the next generation of inorganic chemists are extensive, and novel solutions can be anticipated.

Solution of problems

1.1

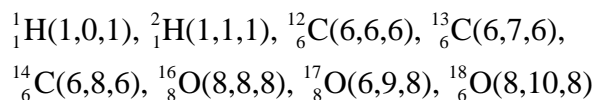

2.1

$$\Delta = 428 - \sqrt{432 \times 239}$$

$$= 106.6 \text{ kJ mol}^{-1} = 25.48 \text{ kcal mol}^{-1}$$

$$\chi_{\text{Cl}} - \chi_{\text{H}} = 0.208 \times \sqrt{25.48}, \quad \chi_{\text{Cl}} = 2.1 + 1.05 = 3.15$$

2.2 In a σ bond, a bonding orbital is a centrosymmetric g orbital, whereas an antibonding orbital is a non-centrosymmetric u orbital.

3.1 $\text{O}_2(0), \text{H}_2\text{O}_2(-1), \text{H}_2\text{O}(-2)$.

$$E_0 = \frac{0.70 + 1.76}{2} = 1.23 \text{ V}$$

Since the reduction potential is positive, the reaction is spontaneous.

3.2 As the $\text{p}K_{\text{a}}$ of the conjugate acids NH_4^+ is 9.25, and $\text{C}_5\text{H}_5\text{NH}^+$ 5.25, ammonia is more protophilic than pyridine and is a stronger base.

3.3 Electronegativities of halogens are in the order $\text{F} > \text{Cl} > \text{Br}$. A boron trihalide bonded to more electronegative halogens attracts more electrons and the Lewis acidity should become larger. However, opposite tendency is observed and this is considered to be due to π bonding between boron and halogen.

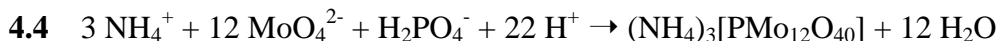
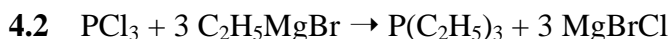
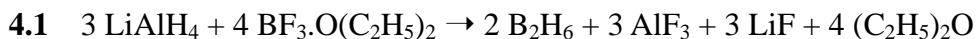

4.5

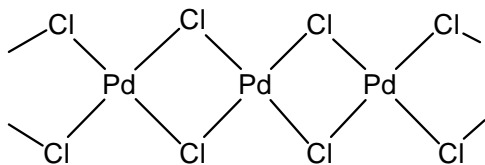

4.7

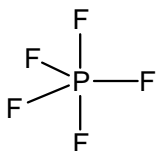

5.2 Because six ether oxygen atoms of a benzene-soluble crown ether (*e.g.* 18-dibenzo-crown-6) in a cyclic arrangement coordinate to potassium cation K^+ .

5.3 Two methyl groups in the dimeric $\text{Al}_2(\text{CH}_3)_6$ bridge two aluminum atoms to form formally 8 covalent bonds requiring 16 electrons. The compound is called electron-deficient because only 12 electrons are supplied from two aluminum atoms (6) and six methyl groups (6).

6.1 Oxide ions are weak-field ligands and transition metal ions assume high-spin states. Fe^{3+} ions have d^5 electron configurations and the LFSE is zero either in the octahedral or in tetrahedral coordination. On the other hand, Fe^{2+} ions tend to enter octahedral holes, because the LFSE for the octahedral coordination by six oxide ligands is larger than the one for tetrahedral coordination by four oxide ligands. This is one of the reasons why magnetite Fe_3O_4 has an inverse spinel structure $\text{B}^{3+}[\text{A}^{2+}\text{B}^{3+}]_2\text{O}_4$.

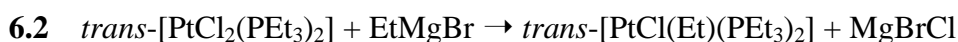

6.3 $\text{CpV}(\text{CO})_4$, $[\text{CpFe}(\text{CO})_2]_2$

6.4 The trans effect of Cl^- is larger than that of NH_3 . Therefore, it is possible to synthesize geometrical isomers selectively by choosing starting compounds.

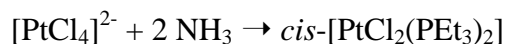
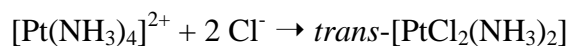

6.5 Unless $[\text{Cr}^{36}\text{Cl}(\text{NH}_3)_5]^{2+}$ forms by the addition of an isotope ion ^{36}Cl to the aqueous solution of the reaction



it is concluded that the chloride ion coordinated to cobalt transfers to chromium by the inner-sphere mechanism via a bridged structure $[(\text{NH}_3)_5\text{-Co-Cl-Cr}(\text{OH}_2)_5]^{4+}$.

7.1 Most of lanthanide ions are stable in the 3+ oxidation states but Ce^{4+} and Eu^{2+} are stable ions and solubilities and adsorption ability in the solvent extraction are significantly different from those of other lanthanides which makes the separation easier.

7.2

$$\frac{N}{N_0} = e^{-\lambda \times \frac{\ln 2}{\lambda} \times 10} = e^{-\ln 10} = 2^{-10} = 9.77 \times 10^{-4}$$

8.1 Figure A.1 shows the catalytic cycle.

8.2 The Haber-Bosch process utilizes solid state catalysts containing iron to produce ammonia at high temperatures (440~550 °C) and under high pressures (100~1000 atm). On the other hand, biological nitrogen fixation produces ammonia from air and water under ambient conditions by the action of nitrogenases.

8.3 The unit lattice in the actual structure is shown in Figure A.2.

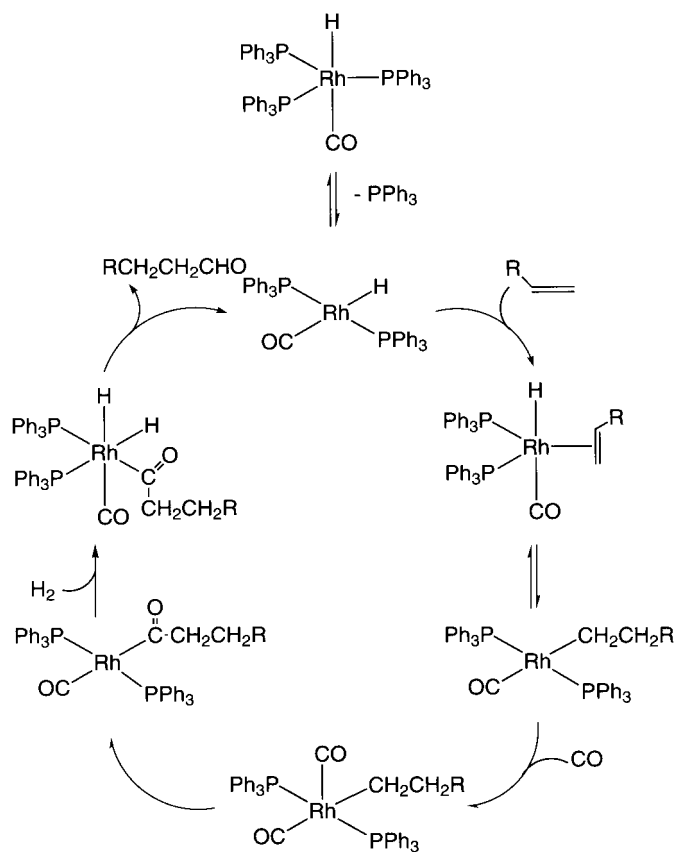

Fig. A.1.

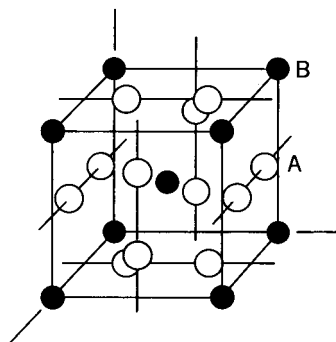

Fig. A.2.

Subject Index

18-electron rule	137	asymmetric synthesis	139
2c-2e bond	12	atomic number	1
3c-2e bond	58	atomic orbital	32
α disintegration	157	atomic radius	14
acceptor number	51	azide ion	91
acetylacetonato	112	azimuthal quantum number	2
acid	48	β -disintegration	157
aconitase	163	β elimination	134
actinoid	155	back donation	132
adenosine triphosphate	75	barium titanate	83
agostic interaction	134	base	48
albite	70	bauxite	105
alkali metal	101	Bednorz	168
alkaline earth metal	103	bent-sandwich	136
alkyl ligand	134	benzophenone complex	102
allosteric effect	164	Berry's pseudorotation	114
allotrope	7	Berthollide compound	9
alnico magnet	170	beryl	103
alumina	81	beryllium chloride	95
aluminosilicate	70	binaphthyldiphosphine	161
aluminum trichloride	94	bioinorganic chemistry	163
ammine	112	bipyridine	112
ammonia	56	black phosphorus	65
ammonia synthesis	162	black selenium	87
ammonium nitrate	72	body-centered cubic lattice	19
anionic ligand	112	Bohr magneton	129
antibonding molecular orbital	32	bonding molecular orbital	32
antiferromagnetic substance	130	borane	58
aqua	112	Born-Haber cycle	15
aqua ion	111	boron trifluoride	92
<i>aqua regia</i>	74	Brønsted-Lowry acid base	48
arene complex	137	Brown	58
argon	98	bulk metal	7
Arrhenius acid and base	48	butyllithium	105
		cadmium iodide	96
arsenic pentafluoride	93	calcium chloride	97
associative mechanism	150	calcium fluoride	97
asymmetric hydrogenation	161	calcium hydride	56
		calcium hydroxide	104

carbonato	112	cubic close packed	17
carbonyl	112	Curie	104
carbonyl cluster	146	Curie temperature	130
carboxypeptidase	163	Curie's law	128
catalysis	159	cyanide ion	91
catalyst	159	cyano	112
cationic ligand	112	cyanogen	91
cesium chloride	97	cyclic voltammetry	47
cesium chloride structure	22	cyclopentadienyl	112
chalcogen	86	cytochrome	163
charge transfer transition	126	<i>d</i> block element	6
chelate ligand	112	Daltonide compound	9
Chevrel phase	168	<i>d-d</i> transition	126
chloric acid	91	degenerate orbital	33
chloro	112	density of state	168
chlorophyll	163	deoxyribonucleic acid	76
chlorous acid	91	diamond	62
chromium trioxide	78	diborane	56
chromium(II) chloride	97	diethylzinc	105
chromium(III) chloride	97	dihydrogen complex	139
<i>closo</i>	59	dinitrogen complex	140
cluster complex	146	dinitrogen monoxide	72
cluster compound	7	dinitrogen pentoxide	73
cluster valence electron	146	dinitrogen trioxide	73
cobalt rare earth magnet	170	dinuclear complex	144
cobalt(II) chloride	96	dioxygen	66
compound semiconductor	167	dioxygen complex	141
conduction electron	12	dispersion force	17
cone angle	65	dissociative mechanism	151
conjugate acid	48	dithionic acid	76
conjugate base	48	<i>dⁿ</i> configuration	111
coordinate bond	12	dolomite	103
coordination and dissociation	160	donor number	51
coordination compound	112	early transition metal	111
coordination number	112	effective nuclear charge	27
copper(I) chloride	97	electrochemical series	45
corundum structure	81	electron affinity	28
covalent radius	13	electron carrier	163
Cp star	135	electron neutrality principle	12
cryolite	105	electron-deficient bond	12
cryptand complex	102	electron-deficient compound	59
crystal field theory	116	electronegativity	29

emerald	103	hemocyanin	163
enthalpy	41	hemoglobin	163
entropy	42	heterogeneous catalyst	162
entropy of activation	151	heteropoly acid	84
essential element	163	hexafluorophosphate	93
ethylenediaminetetraacetate	112	hexagonal close packed	17
<i>f</i> block element	6	high spin configuration	119
face-centered cubic lattice	18	Hodgkin	134
Faraday method	128	HOMO	33
faujasite	71	homogeneous catalysis	159
feldspar	70	homoleptic alkyl	134
ferredoxin	147	Hund's rule	3
ferrite magnet	170	hydride complex	57
ferritin	163	hydride complex	139
ferromagnetic	130	hydride ligand	134
fine ceramics	81	hydrido	112
Fischer	130	hydroboration	58
fluoride glass	171	hydrocarbon complex	133
fluorite	23	hydroformylation	159
fluorite structure	23	hydrogen bond	12
formation constant	149	hydrogen cyanide	91
Friedel-Crafts reaction	95	hydrogen fluoride	57
frontier orbital	33	hydrogen peroxide	68
Fukui	33	hydrogen sulfide	56
fullerene	62	hydrogenase	163
geometrical isomer	114	hydrogenation	159
Gibbs energy	42	hydrolase	163
gold(I) iodide	95	hydroxylamine	74
Gouy method	128	hyper valency	12
graphite	61	hypochlorous acid	91
Grignard	103	hypophosphorous acid	75
Grignard reagent	103	inner-sphere mechanism	153
Haber	162	insertion	160
Haber-Bosch process	56	intercalation compound	61
half life	156	interchange mechanism	150
halogen	89	inverse spinel structure	82
Hammett's acidity function	50	ionic bond	12
hapticity	133	ionic radius	14
hard acid	51	ionization energy	27
hard magnet	170	iron porphyrin	164
helium	98	iron(II) chloride	97
heme iron	164	iron(III) chloride	97

iron-molybdenum cofactor	165	magnetic quantum number	2
isomerase	163	main group element	6
isopoly acid	84	manganese dioxide	81
IUPAC	6	Marcus	153
Jahn-Teller effect	121	mass number	1
Kamerlingh Onnes	168	Mendeleev	6
Keggin structure	84	mercury oxide	78
lanthanide contraction	155	mercury(II) chloride	94
lanthanoid	154	metal carbonyl	130
late transition metal	111	metal cluster compound	145
Latimer diagram	46	metal complex	111
lattice enthalpy	15	metallic bond	12
Lauher's rule	146	metallic hydride	57
lead oxide	78	metallothionein	163
leveling effect	50	metal-metal bond	142
Lewis acid	51	mica	70
Lewis acid catalyst	95	myoglobin	163
Lewis base	51	mixed valence	85
Lewis structure	11	mixed valence compound	107
ligand	111	mixed-ligand complex	113
ligand field	117	M-M multiple bond	143
ligand field stabilization energy	118	MOCVD	167
ligand field transition	126	Moisson	90
ligand field splitting parameter	119	molar susceptibility	128
ligand field theory	116	molecular beam epitaxy	167
ligand reaction	160	molecular hydride	56
ligand substitution	149	molecular magnet	170
ligand substitution	150	molecular orbital	32
light emitting diode	171	molecular sieve	71
lime	104	molybdenum dichloride	89
Lipscomb	58	molybdenum pentachloride	25
lithium hydride	55	molybdenum trioxide	78
lithium tetrahydroaluminate	56	monodentate ligand	112
London interaction	17	Müller	168
lone pair	11	Mulliken	30
low-spin configuration	119	multi-center coordination	148
LUMO	33	multi-electron transfer	148
Madelung constant	16	muscovite	70
magnesium chloride	103	Na/K ion pumping	163
magnetic domain	130	naked nickel	136
magnetism	170	nanotube	63
magnetization	128	naphthalene complex	102

Natta	130	oxygen transportation	163
Néel temperature	130	oxygenase	163
neptunium	2	ozone	67
neutral ligand	112	π acidity	138
<i>nido</i>	60	π allyl complex	135
nitric acid	74	<i>p</i> block element	6
nitric oxide	72	π bond	124
nitrogen dioxide	73	π cyclopentadienyl complex	135
nitrogen fixation	164	<i>p</i> orbital	4
nitrogenase	163	P-450	163
nitrosonium	72	pairing energy	118
nitrous acid	74	palladium chloride	95
nitroyl	73	<i>para</i> -hydrogen	55
nonbonding molecular orbital	32	paramagnetism	128
nonlinear optics	171	Pauli principle	3
nonstoichiometric compound	9	Pauling	29
normal spinel structure	82	pentacarbonyliron	130
nuclear chemistry	156	perchloric acid	92
octahedral hole	20	perovskite	83
octet rule	11	peroxide ion	67
O_h hole	20	phase transition	9
olefin complex	136	phosphine	56
optical fiber	170	phosphine complex	138
optical isomer	115	phosphinic acid	75
organometallic compound	130	phosphite	66
orthoclase	70	phosphonic acid	75
<i>ortho</i> -hydrogen	55	phosphorous acid	75
orthophosphoric acid	75	phosphorus pentachloride	93
osmium tetroxide	77	phosphorus pentafluoride	93
Ostwald process	74	phosphorus pentoxide	25
outer-sphere mechanism	153	phosphorus trichloride	93
overall formation constant	149	phosphorus trifluoride	93
oxidant	45	phosphorus trioxide	75
oxidation	45	photosynthesis	165
oxidation number	45	photosystem I	165
oxidative addition	160	photosystem II	165
oxidoreductase	163	picket fence porphyrin	164
oxoacid	74	pitchblende	104
oxonium ion	49	platinum fluoride	98
oxophilic	111	plutonium hexafluoride	91
oxygen chloride	91	polydentate ligand	112
oxygen difluoride	91	polydentate phosphine	139

polymorphism	9	solid electrolyte	170
polynuclear complex	145	solid-state compound	8
polyoxo acid	84	spectrochemical series	127
polysulfide anion	87	spinel	82
principal quantum number	2	spin-only	129
promethium	2	square planar complex	113
proton	54	SQUID	128
pseudohalogen	91	stability	149
pyrophosphoric acid	75	stabilized zirconia	81
radioactivity	156	standard enthalpy of formation	41
radius ratio	23	standard hydrogen electrode	43
Ramsay	98	standard reduction potential	44
rare gas	98	standard state	42
red phosphorus	65	strong field	119
reductant	45	suboxide	79
reduction	45	successive formation constant	149
reductive elimination	160	sulfur chloride	93
Reppe process	159	sulfur dioxide	76
rhenium trioxide	81	sulfur hexafluoride	93
rock salt structure	21	sulfur trioxide	76
ruthenium tetroxide	77	sulfuric acid	76
rutile	80	sulfurous acid	76
s block element	6	super acid	51
σ bond	121	super oxide ion	67
s orbital	4	superconductivity	167
saline hydride	55	superheavy element	9
sandwich compound	136	superoxide	79
saturated calomel electrode	43	surface complex	162
SHG	171	surface organometallic compound	162
shielding constant	27	synthetic zeolite A	71
silane	56	synthetic zeolite ZSM-5	71
silicone	64	Tanabe-Sugano diagram	127
singlet dioxygen	67	Taube	151
singlet state	55	T_d hole	20
small molecule	139	technetium	2
small molecule complex	139	tertiary phosphine	66
sodium chloride	97	tetracarbonylnickel	130
sodium metaaluminate	71	tetrachlorosilane	92
sodium tetrahydridoborate	56	tetrafluoroborate	92
sodium thiocyanate	91	tetragonal distortion	122
soft acid	51	tetrahedral complex	113
soft magnet	170		

tetrahedral complex	120	Ziegler-Natta catalysis	159
tetrahedral hole	20	zinc blende structure	22
thallium cyclopentadienide	107	Zintl phase	109
thermistor	169	zirconium dioxide	81
thiocyanate	91	zirconium tetrachloride	96
thiocyanato	112		
thiosulfuric acid	76		
thulium	157		
tin oxide	78		
tin(IV) chloride	95		
titanium(IV) chloride	95		
trans effect	151		
transferrin	163		
tricyclohexylphosphine	113		
trigonal bipyramid structure	114		
trimethylaluminum	106		
triphenylphosphine	112		
triplet dioxygen	67		
triplet state	55		
tropylium cation	112		
tungsten trioxide	82		
unit lattice	8		
unpaired electron	128		
Urey	54		
van der Waals interaction	12		
varistor	170		
Vaska's complex	141		
vitamin B ₁₂	163		
volume susceptibility	128		
Wacker process	96		
Wade's rule	61		
water	67		
weak field	119		
white phosphorus	64		
Wilkinson	130		
Wilkinson catalyst	159		
xenon	98		
YAG laser	171		
Zeise's salt	130		
zeolite	70		
Ziegler	108		
Ziegler catalyst	130		

Formula Index

AgBF ₄	92	BeO	80
AgCl	94	BiCl ₃	92
Ag ₂ O	77	BiF ₅	92
Ag ₂ O ₂	77	Bi ₂ O ₃	72
Al(CH ₂ CH ₃) ₃	107	Br ₂	90
Al(CH ₃) ₃	106	BrCl	91
AlCl ₃	94	BrF ₃	92
Al ₂ O ₃	81	BrF ₅	92
LiAlH ₄	56	C ₆₀	62
NaAlO ₂	71	(C ₆ H ₅) ₂ CO	102
Na ₃ AlF ₆	105	(CN) ₂	91
As(CH ₃) ₃	167	CO	39
AsCl ₃	92	CO ₂	72
AsF ₅	93	CaCl ₂	97
As ₄ O ₆	75	CaCO ₃	104
As ₄ O ₁₀	72	CaF ₂	97
AuCl	94	CaH ₂	56
AuCl ₃	94	CaMg(CO ₃) ₂	103
AuI	95	CaO	80
BF ₃	92	Ca(OH) ₂	104
B ₂ H ₆	56	Ca ₃ (PO ₄) ₂	64
B ₄ H ₁₀	60	CdCl ₂	92
B ₅ H ₉	60	CdI ₂	96
[B ₆ H ₆] ²⁻	60	CdO	72
[B ₁₂ H ₁₂] ²⁻	60	CdS	167
B ₂ O ₃	72	Cl ₂	90
(C ₂ H ₅) ₂ O:BF ₃	92	ClF ₃	91
NaBH ₄	56	ClF ₅	92
BaCl ₂	92	Cl ₂ O	91
BaO	72	ClO ₂	92
BaS ₃	87	CCl ₄	92
BaSO ₄	104	HClO	91
Be ₃ Al ₂ Si ₆ O ₁₈	103	HClO ₂	91
BeCl ₂	95	HClO ₃	91

HClO ₄	92	[Fe(C ₅ H ₅)(CO) ₂] ₂	138
Co(C ₃ H ₅) ₃	135	Fe(CO) ₅	132
Co ₂ (CO) ₈	132	Fe ₂ (CO) ₉	132
Co ₄ (CO) ₁₂	145	Fe ₃ (CO) ₁₂	145
CoCl ₂	96	[Fe(CO) ₂ (NO) ₂]	73
[CoCl ₂ (PPh ₃) ₂]	139	FeCl ₂	97
CoF ₃	94	FeCl ₃	97
CoFe ₂ O ₄	170	[FeCl ₂ (PPh ₃) ₂]	139
[CoH(N ₂)(PPh ₃) ₃]	140	[Fe{N(SiMe ₃) ₃ } ₃]	113
[CoMe(py)(dmg) ₂]	134	FeO	80
[Co(NH ₃) ₅ NO]Br ₂	73	Fe ₂ O ₃	52
CoO	77	Fe ₃ O ₄	52
Cp ₂ Co	136	FeS ₂	52
Cr(C ₆ H ₆) ₂	137	[Fe ₄ S ₄ (SR) ₄] ²⁻	148
Cr(CO) ₃ (C ₆ H ₆)	137	FeSi	103
Cr(CO) ₆	132	Cp ₂ Fe	136
CrCl ₂	97	CpFeMe(CO) ₂	134
CrCl ₃	97	GaAs	167
[CrCl ₂ (dmpe) ₂]	139	Ga ₂ O ₃	72
CrF ₄	94	GeCl ₄	92
CrF ₅	94	GeF ₂	92
[Cr(NH ₃) ₆] ³⁺	126	GeO ₂	84
CrO ₂	81	H ₂	36
CrO ₃	77	H ₂ O	67
Cr ₂ O ₃	77	H ₂ O ₂	68
Cp ₂ Cr	136	H ₂ S	56
CsCl	22	HCN	91
Cs ₂ O	79	HF	38
Cs ₁₁ O ₃	79	HfCl	94
CuCl	97	HfCl ₄	94
CuCl ₂	94	[HfCl ₄ (dppe)]	139
CuO	77	HfO ₂	136
Cu ₂ O	77	Cp ₂ HfCl ₂	136
YBa ₂ Cu ₃ O _{7-x}	168	HgCl ₂	94
D ₂	55	Hg ₂ Cl ₂	92
F ₂	90	HgO	78
Fe(C ₅ H ₅) ₂	130	I ₂	90

IBr	91	MgO	72
ICl	91	RMgBr	105
IF ₅	92	Mn ₂ (CO) ₁₀	132
IF ₇	91	MnCl ₂	94
I ₂ O ₅	72	MnO	77
InCl	92	MnO ₂	81
InCl ₃	92	[Mn(CO) ₄ (PPh ₃) ₂]	139
In ₂ O ₃	72	Cp ₂ Mn	136
InP	167	Mo(C ₆ H ₆)(CO) ₃	138
Ir ₄ (CO) ₁₂	132	[Mo ₂ (CH ₃ COO) ₄]	144
IrCl ₃	105	[Mo(CN) ₈] ³⁻	116
[IrCl(CO)(PPh ₃) ₂]	160	Mo(CO) ₆	132
[IrCl ₃ (PPh ₃) ₃]	139	MoCl ₂	89
IrF ₅	94	MoCl ₃	94
IrF ₆	94	MoCl ₄	94
IrO ₂	81	MoCl ₅	25
KCl	92	[MoCl ₃ (PMePh ₂) ₃]	139
KO ₂	72	MoO ₂	77
K ₂ O	72	MoO ₃	78
K ₂ O ₂	72	[Mo(PMe ₂ Ph) ₄ (N ₂) ₂]	141
K ₂ S ₅	87	MoS ₂	88
KrF ₂	92	[Mo ₂ (S ₂) ₆] ²⁻	87
LaCl	94	[Mo ₆ S ₈ L ₆]	147
LaF ₃	94	Mo ₆ X ₁₂	146
LaNi ₅	57	Cp ₂ MoCl ₂	136
LaNi ₅ H ₆	57	Cp ₂ MoH ₂	136
Li ₂	36	M _x Mo ₆ X ₈	89
LiBu	105	[PMo ₁₂ O ₄₀] ³⁻	85
LiCl	92	N ₂	36
LiH	55	NF ₃	92
Li ₂ O	72	NH ₂ OH	74
Cp ₃ Ln	155	NH ₃	56
Cp ₂ LaX	155	NO	72
MgAl ₂ O ₄	82	NO ₂	73
MgB ₂	58	N ₂ O	72
MgCl ₂	103	N ₂ O ₃	73
Mg ₃ N ₂	103	NOBF ₄	73

NOHSO ₄	73	[OsCl ₃ (PPh ₃) ₃]	139
HNO ₂	74	OsF ₅	94
HNO ₃	74	OsF ₆	94
H ₂ N ₂ O ₂	74	OsF ₇	94
Na(C ₅ H ₅)	135	OsO ₂	81
NaCl	21	OsO ₄	77
NaNO ₂	74	Cp ₂ Os	136
NaO ₂	72	P ^t Bu ₃	66
Na ₂ O	72	P(C ₂ H ₅) ₃	65
Na ₂ O ₂	79	P(C ₆ H ₅) ₃	65
Na ₂ S ₂	87	PCl ₃	92
NaSCN	91	PCl ₅	92
NbCl ₄	94	PF ₃	92
NbCl ₅	94	PF ₅	92
[NbCl ₄ (PEtPh ₂) ₂]	139	PH ₃	56
Nb ₃ Ge	168	PMe ₃	66
NbO	77	PMe ₂ Ph	66
NbO ₂	77	P ₂ O ₅	25
Nb ₂ O ₅	77	P ₄ O ₆	75
Nb ₃ Sn	168	P ₄ O ₁₀	75
Nb ₆ X ₁₄	146	P(OEt) ₃	66
Cp ₂ NbCl ₂	136	P(OPh) ₃	66
LiNbO ₃	171	P ⁱ Pr ₃	66
Ni(η ³ -C ₃ H ₅) ₂	134	H ₃ PO ₂	83
Ni(CO) ₄	132	H ₃ PO ₃	75
NiCl ₂	94	H ₃ PO ₄	75
[NiCl ₂ (PEt ₃) ₂]	139	H ₄ P ₂ O ₇	75
Ni(cod) ₂	136	R ₄ NPF ₆	93
[Ni(dmit) ₂] ²⁻	169	PbCl ₂	92
NiEt ₂ (bipy)	134	PbCl ₄	92
NiO	77	PbO	77
Cp ₂ Ni	136	PbO ₂	108
O ₂	37	PdCl ₂	95
O ₃	67	[PdCl ₂ (PPh ₃) ₂]	139
OF ₂	91	[Pd(PCy ₃) ₂]	113
Os ₃ (CO) ₁₂	132	PtCl ₂	94
OsCl ₃	94	<i>cis</i> -[PtCl ₂ (NH ₃) ₂]	114

[PtCl ₂ (PPh ₃) ₂]	139	RuO ₂	81
PtCl ₄	94	RuO ₄	77
PtCl(Et)(PEt ₃) ₂]	134	Cp ₂ Ru	136
PtF ₅	94	S ₈	87
PtF ₆	99	S ₂ Cl ₂	93
PtO ₂	77	SF ₆	93
O ₂ PtF ₆	99	SO ₂	76
PuF ₆	91	SO ₃	76
RbCl	92	H ₂ SO ₃	76
Rb ₂ O	72	H ₂ SO ₄	76
Rb ₂ O ₂	72	H ₂ S ₂ O ₃	76
Rb ₉ O ₂	79	H ₂ S ₂ O ₆	76
Re ₂ (CO) ₁₀	132	SbCl ₃	92
ReCl ₃	94	SbF ₅	92
ReCl ₄	94	Sb ₂ O ₁₀	72
ReCl ₅	94	Sb ₄ O ₈	75
[ReCl ₃ (PMe ₂ Ph) ₃]	139	ScCl	94
Re ₂ Cl ₈ ²⁻	143	Sc ₂ O ₃	77
ReF ₆	94	Se ₈	87
ReF ₇	94	Se ₂ Cl ₂	92
[ReH ₉] ²⁻	116	SeF ₆	92
ReO ₂	77	SeO ₂	72
ReO ₃	81	SeO ₃	72
Re ₂ O ₇	77	SiCl ₄	92
[Re{S ₂ C ₂ (CF ₃) ₂ } ₃]	115	SiH ₄	56
Cp ₂ ReH	136	SiO ₂	72
Rh ₆ (CO) ₁₆	132	KAl ₂ (OH) ₂ Si ₃ AlO ₁₀	70
RhCl ₃	94	KAlSi ₃ O ₈	70
[RhCl(PPh ₃) ₃]	159	(Mes) ₂ Si=Si(Mea) ₂	64
RhO ₂	77	NaAlSi ₃ O ₈	70
Rh ₂ O ₃	77	[Na ₁₂ (Al ₂ Si ₁₂ O ₄₈)].27H ₂ O	71
[Ru(bipy) ₃] ²⁺	127	[NaCa _{0.5} (Al ₂ Si ₅ O ₁₄)].10H ₂ O	71
Ru ₃ (CO) ₃	132	SmCo ₅	170
RuCl ₂	94	SnCl ₂	92
RuCl ₃	94	SnCl ₄	94
[RuCl ₂ (PPh ₃) ₃]	159	SnO	77
[Ru(N ₂)(NH ₃) ₅]X ₂	140	SnO ₂	84

[Na(crypt)] ₄ [Sn ₉]	109	TiCl ₃	92
Sr ₃ N ₂	104	Tl ₂ O	72
SrCl ₂	92	Tl ₂ O ₃	72
SrO	104	U(η ⁸ -C ₈ H ₈) ₂	134
T ₂	55	UF ₆	158
TaCl ₄	94	V(CO) ₆	132
TaCl ₅	94	VCl ₂	94
[TaCl ₄ (PEt ₃) ₂]	139	VCl ₃	94
TaO ₂	77	VCl ₄	94
Ta ₂ O ₅	77	[VCl ₃ (PMePh ₂) ₂]	139
TaS ₂	88	VF ₅	94
Ta ₆ X ₁₄	146	V ₃ Ga	168
Cp ₂ TaCl ₂	136	VO	77
Tc ₂ (CO) ₁₀	132	VO ₂	77
[TcCl ₃ (PMe ₂ Ph) ₃]	139	V ₂ O ₃	77
TcO ₂	86	V ₂ O ₅	77
Cp ₂ TcH	136	Cp ₂ V	136
Te ₄ Cl ₁₆	92	W(CH ₃) ₆	134
TeF ₆	92	W(CO) ₆	132
TeO ₂	72	[W(CO) ₃ (H ₂)(P ⁱ Pr ₃) ₂]	139
TeO ₃	72	WCl ₂	94
ThO ₂	157	WCl ₃	94
TiCl ₂	94	WCl ₄	94
TiCl ₃	94	WCl ₅	94
TiCl ₄	95	WCl ₆	94
[TiCl ₄ (PPh ₃) ₂]	139	[WCl ₄ (PPh ₃) ₂]	139
TiO	77	[W ₂ Cl ₉] ³⁻	144
TiO ₂	80	[W ₂ (NMe ₂) ₆]	144
Ti ₂ O	77	WO ₂	77
Ti ₂ O ₃	77	WO ₃	82
[Ti(OH ₂) ₆] ³⁺	139	W ₁₈ O ₄₉	82
BaTiO ₃	83	W ₂₀ O ₅₈	82
CaTiO ₃	83	W ₆ X ₁₂	146
Cp ₂ TiCl ₂	136	Cp ₂ W(S ₄)	87
SrTiO ₃	170	Cp ₂ WCl ₂	136
Tl(C ₅ H ₅)	107	XeF ₂	98
TlCl	92	XeF ₄	98

XeF ₆	98
XeO ₃	98
XeO ₄	99
Xe[PtF ₆] _x	98
M[XeF ₈]	99
Y ₃ Al ₅ O ₁₂	171
YCl	94
YCl ₃	94
Y ₂ O ₃	77
ZnCl ₂	92
ZnEt ₂	105
ZnO	72
ZnS	22
ZrCl	94
ZrCl ₃	94
ZrCl ₄	96
[ZrCl ₄ (dppe)]	139
ZrO ₂	81
ZrS ₂	88
Cp ₂ ZrCl ₂	136