

# Organic Structures from Spectra

Fourth Edition



# Organic Structures from Spectra

Fourth Edition

**L D Field**

*University of New South Wales, Australia*

**S Sternhell**

*University of Sydney, Australia*

**J R Kalman**

*University of Technology Sydney, Australia*



**WILEY**

**JOHN WILEY AND SONS, LTD**



Copyright © 2008 John Wiley & Sons Ltd, The Atrium, Southern Gate, Chichester,  
West Sussex PO19 8SQ, England

Telephone (+44) 1243 779777

Email (for orders and customer service enquiries): [cs-books@wiley.co.uk](mailto:cs-books@wiley.co.uk)  
Visit our Home Page on [www.wileyurope.com](http://www.wileyurope.com) or [www.wiley.com](http://www.wiley.com)

All Rights Reserved. No part of this publication may be reproduced, stored in a retrieval system or transmitted in any form or by any means, electronic, mechanical, photocopying, recording, scanning or otherwise, except under the terms of the Copyright, Designs and Patents Act 1988 or under the terms of a licence issued by the Copyright Licensing Agency Ltd, 90 Tottenham Court Road, London W1T 4LP, UK, without the permission in writing of the Publisher. Requests to the Publisher should be addressed to the Permissions Department, John Wiley & Sons Ltd, The Atrium, Southern Gate, Chichester, West Sussex PO19 8SQ, England, or emailed to [permreq@wiley.co.uk](mailto:permreq@wiley.co.uk), or faxed to (+44) 1243 770620.

Designations used by companies to distinguish their products are often claimed as trademarks. All brand names and product names used in this book are trade names, service marks, trademarks or registered trademarks of their respective owners. The Publisher is not associated with any product or vendor mentioned in this book.

This publication is designed to provide accurate and authoritative information in regard to the subject matter covered. It is sold on the understanding that the Publisher is not engaged in rendering professional services. If professional advice or other expert assistance is required, the services of a competent professional should be sought.

The Publisher and the Author make no representations or warranties with respect to the accuracy or completeness of the contents of this work and specifically disclaim all warranties, including without limitation any implied warranties of fitness for a particular purpose. The advice and strategies contained herein may not be suitable for every situation. In view of ongoing research, equipment modifications, changes in governmental regulations, and the constant flow of information relating to the use of experimental reagents, equipment, and devices, the reader is urged to review and evaluate the information provided in the package insert or instructions for each chemical, piece of equipment, reagent, or device for, among other things, any changes in the instructions or indication of usage and for added warnings and precautions. The fact that an organization or Website is referred to in this work as a citation and/or a potential source of further information does not mean that the author or the publisher endorses the information the organization or Website may provide or recommendations it may make. Further, readers should be aware that Internet Websites listed in this work may have changed or disappeared between when this work was written and when it is read. No warranty may be created or extended by any promotional statements for this work. Neither the Publisher nor the Author shall be liable for any damages arising herefrom.

#### ***Other Wiley Editorial Offices***

John Wiley & Sons Inc., 111 River Street, Hoboken, NJ 07030, USA

Jossey-Bass, 989 Market Street, San Francisco, CA 94103-1741, USA

Wiley-VCH Verlag GmbH, Boschstr. 12, D-69469 Weinheim, Germany

John Wiley & Sons Australia Ltd, 42 McDougall Street, Milton, Queensland 4064, Australia

John Wiley & Sons (Asia) Pte Ltd, 2 Clementi Loop #02-01, Jin Xing Distripark, Singapore 129809

John Wiley & Sons Ltd, 6045 Freemont Blvd, Mississauga, Ontario L5R 4J3, Canada

Wiley also publishes its books in a variety of electronic formats. Some content that appears in print may not be available in electronic books.

#### ***British Library Cataloguing in Publication Data***

A catalogue record for this book is available from the British Library

ISBN 978-0-470-31926-0 (H/B)

ISBN 978-0-470-31927-7 (P/B)

Printed and bound in Great Britain by Antony Rowe Ltd, Chippenham, Wiltshire  
This book is printed on acid-free paper responsibly manufactured from sustainable forestry  
in which at least two trees are planted for each one used for paper production.

# CONTENTS

---

<b>PREFACE</b>	<b>vii</b>
<b>LIST OF TABLES</b>	<b>xi</b>
<b>LIST OF FIGURES</b>	<b>xiii</b>
<b>1 INTRODUCTION</b>	<b>1</b>
1.1 GENERAL PRINCIPLES OF ABSORPTION SPECTROSCOPY	1
1.2 CHROMOPHORES	3
1.3 DEGREE OF UNSATURATION	3
1.4 CONNECTIVITY	4
1.5 SENSITIVITY	5
1.6 PRACTICAL CONSIDERATIONS	5
<b>2 ULTRAVIOLET (UV) SPECTROSCOPY</b>	<b>7</b>
2.1 BASIC INSTRUMENTATION	7
2.2 THE NATURE OF ULTRAVIOLET SPECTROSCOPY	8
2.3 QUANTITATIVE ASPECTS OF ULTRAVIOLET SPECTROSCOPY	8
2.4 CLASSIFICATION OF UV ABSORPTION BANDS	9
2.5 SPECIAL TERMS IN ULTRAVIOLET SPECTROSCOPY	10
2.6 IMPORTANT UV CHROMOPHORES	10
2.7 THE EFFECT OF SOLVENTS	14
<b>3 INFRARED (IR) SPECTROSCOPY</b>	<b>15</b>
3.1 ABSORPTION RANGE AND THE NATURE OF IR ABSORPTION	15
3.2 EXPERIMENTAL ASPECTS OF INFRARED SPECTROSCOPY	16
3.3 GENERAL FEATURES OF INFRARED SPECTRA	16
3.4 IMPORTANT IR CHROMOPHORES	17
<b>4 MASS SPECTROMETRY</b>	<b>21</b>
4.1 IONIZATION PROCESSES	21
4.2 INSTRUMENTATION	23
4.3 MASS SPECTRAL DATA	24
4.4 REPRESENTATION OF FRAGMENTATION PROCESSES	28
4.5 FACTORS GOVERNING FRAGMENTATION PROCESSES	29
4.6 EXAMPLES OF COMMON TYPES OF FRAGMENTATION	29
<b>5 NUCLEAR MAGNETIC RESONANCE (NMR) SPECTROSCOPY</b>	<b>33</b>
5.1 THE PHYSICS OF NUCLEAR SPINS AND NMR INSTRUMENTS	33
5.2 CONTINUOUS WAVE (CW) NMR SPECTROSCOPY	37
5.3 FOURIER-TRANSFORM (FT) NMR SPECTROSCOPY	39
5.4 CHEMICAL SHIFT IN $^1\text{H}$ NMR SPECTROSCOPY	40
5.5 SPIN-SPIN COUPLING IN $^1\text{H}$ NMR SPECTROSCOPY	50
5.6 ANALYSIS OF $^1\text{H}$ NMR SPECTRA	53
5.7 RULES FOR SPECTRAL ANALYSIS	55

<b>6</b>	<b><math>^{13}\text{C}</math> NMR SPECTROSCOPY</b>	<b>65</b>
6.1	COUPLING AND DECOUPLING IN $^{13}\text{C}$ NMR SPECTRA	65
6.2	DETERMINING $^{13}\text{C}$ SIGNAL MULTIPLICITY USING DEPT	67
6.3	SHIELDING AND CHARACTERISTIC CHEMICAL SHIFTS IN $^{13}\text{C}$ NMR SPECTRA	70
<b>7</b>	<b>MISCELLANEOUS TOPICS</b>	<b>75</b>
7.1	DYNAMIC PROCESSES IN NMR - THE NMR TIME-SCALE	75
7.2	THE EFFECT OF CHIRALITY	77
7.3	THE NUCLEAR OVERHAUSER EFFECT (NOE)	79
7.4	TWO DIMENSIONAL NMR	80
7.5	THE NMR SPECTRA OF "OTHER NUCLEI"	84
7.6	SOLVENT - INDUCED SHIFTS	84
<b>8</b>	<b>DETERMINING THE STRUCTURE OF ORGANIC MOLECULES FROM SPECTRA</b>	<b>85</b>
<b>9</b>	<b>PROBLEMS</b>	<b>89</b>
9.1	ORGANIC STRUCTURES FROM SPECTRA	89
9.2	THE ANALYSIS OF MIXTURES	373
9.3	PROBLEMS IN 2-DIMENSIONAL NMR	383
9.4	NMR SPECTRAL ANALYSIS	419
	<b>APPENDIX</b>	<b>444</b>
	<b>INDEX</b>	<b>451</b>

# PREFACE

---

The derivation of structural information from spectroscopic data is an integral part of Organic Chemistry courses at all Universities. At the undergraduate level, the principal aim of such courses is to teach students to solve simple structural problems efficiently by using combinations of the major techniques (UV, IR, NMR and MS), and over more than 25 years we have evolved a course at the University of Sydney, which achieves this aim quickly and painlessly. The text is tailored specifically to the needs and philosophy of this course. As we believe our approach to be successful, we hope that it may be of use in other institutions.

The course has been taught at the beginning of the third year, at which stage students have completed an elementary course of Organic Chemistry in first year and a mechanistically-oriented intermediate course in second year. Students have also been exposed in their Physical Chemistry courses to elementary spectroscopic theory, but are, in general, unable to relate it to the material presented in this course.

The course consists of about 9 lectures outlining the theory, instrumentation and the structure-spectra correlations of the major spectroscopic techniques and the text of this book corresponds to the material presented in the 9 lectures. The treatment is both elementary and condensed and, not surprisingly, the students have great difficulties in solving even the simplest problems at this stage. The lectures are followed by a series of 2-hour problem solving seminars with 5 to 6 problems being presented per seminar. At the conclusion of the course, the great majority of the class is quite proficient and has achieved a satisfactory level of understanding of all methods used. Clearly, the real teaching is done during the problem seminars, which are organised in a manner modelled on that used at the E.T.H. Zurich.

The class (typically 60 - 100 students, attendance is compulsory) is seated in a large lecture theatre in alternate rows and the problems for the day are identified. The students are permitted to work either individually or in groups and may use any written or printed aids they desire. Students solve the problems on their individual copies of this book thereby transforming it into a set of worked examples and we find that most students voluntarily complete many more problems than are set. Staff (generally 4 or 5) wander around giving help and tuition as needed, the empty alternate rows of seats

## Preface

making it possible to speak to each student individually. When an important general point needs to be made, the staff member in charge gives a very brief exposition at the board. There is a 1½ hour examination consisting essentially of 4 problems and the results are in general very satisfactory. Moreover, the students themselves find this a rewarding course since the practical skills acquired are obvious to them. There is also a real sense of achievement and understanding since the challenge in solving the graded problems builds confidence even though the more difficult examples are quite demanding.

Our philosophy can be summarised as follows:

- (a) Theoretical exposition must be kept to a minimum, consistent with gaining of an understanding of the parts of the technique actually used in solving the problems. Our experience indicates that both mathematical detail and description of advanced techniques merely confuse the average student.
- (b) The learning of data must be kept to a minimum. We believe that it is more important to learn to use a restricted range of data well rather than to achieve a nodding acquaintance with more extensive sets of data.
- (c) Emphasis is placed on the concept of identifying "structural elements" and the logic needed to produce a structure out of the structural elements.

We have concluded that the best way to learn how to obtain "structures from spectra" is to practise on simple problems. This book was produced principally to assemble a collection of problems that we consider satisfactory for that purpose.

Problems 1 – 277 are of the standard "structures from spectra" type and are arranged roughly in order of increasing difficulty. A number of problems are groups of isomers which differ mainly in the connectivity of the structural elements and these problems are ideally set together (*e.g.* problems 2 and 3, 22 and 23; 27 and 28; 29, 30 and 31; 40 and 41; 42 to 47; 48 and 49; 58, 59 and 60; 61, 62 and 63; 70, 71 and 72; 77 and 78; 80 and 81; 94, 95 and 96; 101 and 102; 104 to 107; 108 and 109; 112, 113 and 114; 116 and 117; 121 and 122; 123 and 124; 127 and 128; 133 to 137; 150 and 151; 171 and 172; 173 and 174; 178 and 179; 225, 226 and 227; 271 and 272; and 275 and 276). A number of problems exemplify complexities arising from the presence of chiral centres (*e.g.* problems 189, 190, 191, 192, 193, 222, 223, 242, 253, 256, 257, 258, 259, 260, 262, 265, 268, 269 and 270); or of restricted rotation about peptide or amide bonds (*e.g.* problems 122, 153 and 255), while other problems deal with structures of compounds of biological, environmental or industrial significance (*e.g.* problems 20, 21, 90, 121, 125, 126, 138, 147, 148, 153, 155, 180, 191, 197, 213, 252, 254, 256, 257, 258, 259, 260, 266, 268, 269 and 270).



## LIST OF TABLES

Table 2.1	The Effect of Extended Conjugation on UV Absorption	11
Table 2.2	UV Absorption Bands in Common Carbonyl Compounds	12
Table 2.3	UV Absorption Bands in Common Benzene Derivatives	13
Table 3.1	Carbonyl IR Absorption Frequencies in Common Functional Groups	18
Table 3.2	Characteristic IR Absorption Frequencies for Common Functional Groups	19
Table 3.3	IR Absorption Frequencies in the Region 1900 – 2600 cm <sup>-1</sup>	20
Table 4.1	Accurate Masses of Selected Isotopes	25
Table 4.2	Common Fragments and their Masses	27
Table 5.1	Resonance Frequencies of <sup>1</sup> H and <sup>13</sup> C Nuclei in Magnetic Fields of Different Strengths	35
Table 5.2	Typical <sup>1</sup> H Chemical Shift Values in Selected Organic Compounds	43
Table 5.3	Typical <sup>1</sup> H Chemical Shift Ranges in Organic Compounds	44
Table 5.4	<sup>1</sup> H Chemical Shifts (δ) for Protons in Common Alkyl Derivatives	44
Table 5.5	Approximate <sup>1</sup> H Chemical Shifts (δ) for Olefinic Protons C=C-H	45
Table 5.6	<sup>1</sup> H Chemical Shifts (δ) for Aromatic Protons in Benzene Derivatives Ph-X in ppm Relative to Benzene at δ 7.26 ppm	46
Table 5.7	<sup>1</sup> H Chemical Shifts (δ) in some Polynuclear Aromatic Compounds and Heteroaromatic Compounds	46
Table 5.8	Typical <sup>1</sup> H – <sup>1</sup> H Coupling Constants	51
Table 5.9	Relative Line Intensities for Simple Multiplets	51
Table 5.10	Characteristic Multiplet Patterns for Common Organic Fragments	52
Table 6.1	The Number of Aromatic <sup>13</sup> C Resonances in Benzenes with Different Substitution Patterns	69
Table 6.2	Typical <sup>13</sup> C Chemical Shift Values in Selected Organic Compounds	70
Table 6.3	Typical <sup>13</sup> C Chemical Shift Ranges in Organic Compounds	71
Table 6.4	<sup>13</sup> C Chemical Shifts (δ) for <i>sp</i> <sup>3</sup> Carbons in Alkyl Derivatives	72
Table 6.5	<sup>13</sup> C Chemical Shifts (δ) for <i>sp</i> <sup>2</sup> Carbons in Vinyl Derivatives	72
Table 6.6	<sup>13</sup> C Chemical Shifts (δ) for <i>sp</i> Carbons in Alkynes: X-C≡C-Y	73
Table 6.7	Approximate <sup>13</sup> C Chemical Shifts (δ) for Aromatic Carbons in Benzene Derivatives Ph-X in ppm relative to Benzene at δ 128.5 ppm	74
Table 6.8	Characteristic <sup>13</sup> C Chemical Shifts (δ) in some Polynuclear Aromatic Compounds and Heteroaromatic Compounds	74





## LIST OF FIGURES

---

Figure 1.1	Schematic Absorption Spectrum	1
Figure 1.2	Definition of a Spectroscopic Transition	2
Figure 2.1	Schematic Representation of an IR or UV Spectrometer	7
Figure 2.2	Definition of Absorbance ( $A$ )	9
Figure 4.1	Schematic Diagram of an Electron-Impact Mass Spectrometer	23
Figure 5.1	A Spinning Charge Generates a Magnetic Field and Behaves Like a Small Magnet	33
Figure 5.2	Schematic Representation of a CW NMR Spectrometer	38
Figure 5.3	Time Domain and Frequency Domain NMR Spectra	39
Figure 5.4	Shielding/deshielding Zones for Common Non-aromatic Functional Groups	48
Figure 5.5	A Portion of the $^1\text{H}$ NMR Spectrum of Styrene Epoxide (100 MHz as a 5% solution in $\text{CCl}_4$ )	57
Figure 5.6	The 60 MHz $^1\text{H}$ NMR Spectrum of a 4-Spin $\text{AMX}_2$ Spin System	58
Figure 5.7	Simulated $^1\text{H}$ NMR Spectra of a 2-Spin System as the Ratio $\Delta\nu/J$ , is Varied from 10.0 to 0.0	59
Figure 5.8	Selective Decoupling in a Simple 4-Spin System	60
Figure 5.9	$^1\text{H}$ NMR Spectrum of <i>p</i> -Nitrophenylacetylene (200 MHz as a 10% solution in $\text{CDCl}_3$ )	64
Figure 6.1	$^{13}\text{C}$ NMR Spectra of Methyl Cyclopropyl Ketone ( $\text{CDCl}_3$ Solvent, 100 MHz). (a) Spectrum with Full Broad Band Decoupling of $^1\text{H}$ ; (b) DEPT Spectrum (c) Spectrum with no Decoupling of $^1\text{H}$ ; (d) SFORD Spectrum	68
Figure 7.1	Schematic NMR Spectra of Two Exchanging Nuclei	75
Figure 7.2	$^1\text{H}$ NMR Spectrum of the Aliphatic Region of Cysteine Indicating Non-equivalence of the Methylene Protons due to the Influence of the Stereogenic Centre	78



## 1

## INTRODUCTION

## 1.1 GENERAL PRINCIPLES OF ABSORPTION SPECTROSCOPY

The basic principles of absorption spectroscopy are summarised below. These are most obviously applicable to UV and IR spectroscopy and are simply extended to cover NMR spectroscopy. Mass Spectrometry is somewhat different and is not a type of absorption spectroscopy.

*Spectroscopy* is the study of the quantised interaction of energy (typically electromagnetic energy) with matter. In Organic Chemistry, we typically deal with molecular spectroscopy *i.e.* the spectroscopy of atoms that are bound together in molecules.

A schematic absorption spectrum is given in Figure 1.1. The absorption spectrum is a plot of absorption of energy (radiation) against its wavelength ( $\lambda$ ) or frequency ( $\nu$ ).

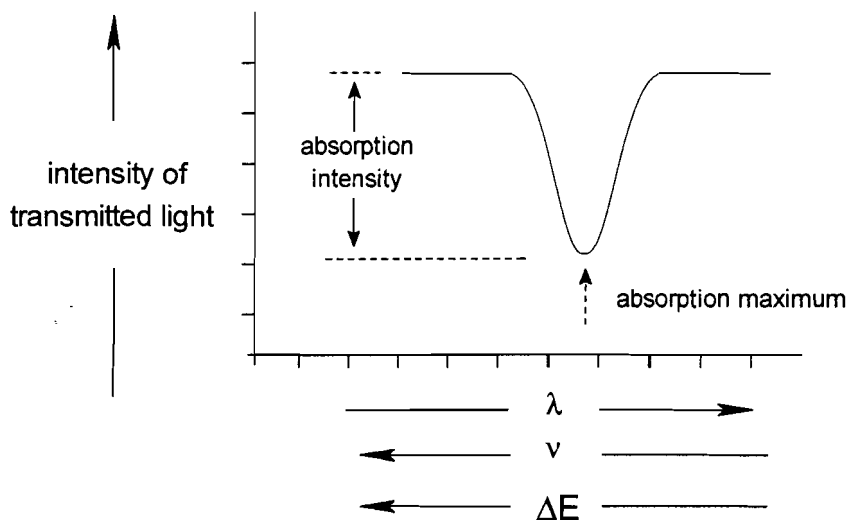

Figure 1.1 Schematic Absorption Spectrum

An absorption band can be characterised primarily by two parameters:

- (a) the wavelength at which maximum absorption occurs
- (b) the intensity of absorption at this wavelength compared to base-line (or background) absorption

A spectroscopic transition takes a molecule from one state to a state of a higher energy. For any spectroscopic transition between energy states (e.g.  $E_1$  and  $E_2$  in Figure 1.2), the change in energy ( $\Delta E$ ) is given by:

$$\Delta E = h\nu$$

where  $h$  is the Planck's constant and  $\nu$  is the frequency of the electromagnetic energy absorbed. Therefore  $\nu \propto \Delta E$ .

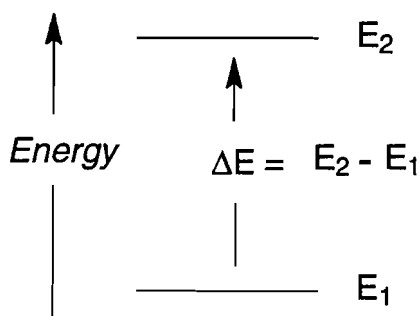

**Figure 1.2 Definition of a Spectroscopic Transition**

It follows that the x-axis in Figure 1.1 is an **energy** scale, since the frequency, wavelength and energy of electromagnetic radiation are interrelated:

$$\nu\lambda = c \text{ (speed of light)}$$

$$\lambda = \frac{c}{\nu}$$

$$\lambda \propto \frac{1}{\Delta E}$$

A spectrum consists of distinct bands or transitions because the absorption (or emission) of energy is quantised. The energy gap of a transition is a **molecular property** and is **characteristic of molecular structure**.

The y-axis in Figure 1.1 measures the intensity of the absorption band and this depends on the number of molecules observed (the Beer-Lambert Law) and the probability of the transition between the energy levels. The absorption intensity is

also a molecular property and both the frequency and the intensity of a transition can provide structural information.

## 1.2 CHROMOPHORES

In general, any spectral feature, *i.e.* a band or group of bands, is due not to the whole molecule, but to an identifiable part of the molecule, which we loosely call a *chromophore*.

A chromophore may correspond to a functional group (*e.g.* a hydroxyl group or the double bond in a carbonyl group). However, it may equally well correspond to a single atom within a molecule or to a group of atoms (*e.g.* a methyl group) which is not normally associated with chemical functionality.

The detection of a chromophore permits us to deduce the presence of a *structural fragment* or a *structural element* in the molecule. The fact that it is the chromophores and not the molecules as a whole that give rise to spectral features is fortunate, otherwise spectroscopy would only permit us to identify known compounds by direct comparison of their spectra with authentic samples. This "fingerprint" technique is often useful for establishing the identity of known compounds, but the direct determination of molecular structure building up from the molecular fragments is far more powerful.

## 1.3 DEGREE OF UNSATURATION

Traditionally, the molecular formula of a compound was derived from elemental analysis and its molecular weight which was determined independently. The concept of the **degree of unsaturation** of an organic compound derives simply from the tetravalency of carbon. For a non-cyclic hydrocarbon (*i.e.* an alkane) the number of hydrogen atoms must be twice the number of carbon atoms plus two, any "deficiency" in the number of hydrogens must be due to the presence of unsaturation, *i.e.* double bonds, triple bonds or rings in the structure.

The degree of unsaturation can be calculated from the molecular formula for all compounds containing C, H, N, O, S or the halogens. There are 3 basic steps in calculating the degree of unsaturation:

**Step 1** – take the molecular formula and replace all halogens by hydrogens

**Step 2** – omit all of the sulfur or oxygen atoms

**Step 3** – for each nitrogen, omit the nitrogen and omit one hydrogen

After these 3 steps, the molecular formula is reduced to  $C_nH_m$  and the degree of unsaturation is given by:

$$\text{Degree of Unsaturation} = n - \frac{m}{2} + 1$$

The degree of unsaturation indicates the number of  $\pi$  bonds or rings that the compound contains. For example, a compound whose molecular formula is  $C_4H_9NO_2$  is reduced to  $C_4H_8$  which gives a degree of unsaturation of 1 and this indicates that the molecule must have one  $\pi$  bond or one ring. Note that any compound that contains an aromatic ring always has a degree of unsaturation greater than or equal to 4, since the aromatic ring contains a ring plus three  $\pi$  bonds. Conversely if a compound has a degree of unsaturation greater than 4, one should suspect the possibility that the structure contains an aromatic ring.

## 1.4 CONNECTIVITY

Even if it were possible to identify sufficient structural elements in a molecule to account for the molecular formula, it may not be possible to deduce the structural formula from a knowledge of the structural elements alone. For example, it could be demonstrated that a substance of molecular formula  $C_3H_5OCl$  contains the structural elements:

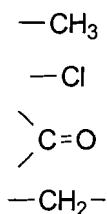

and this leaves two possible structures:

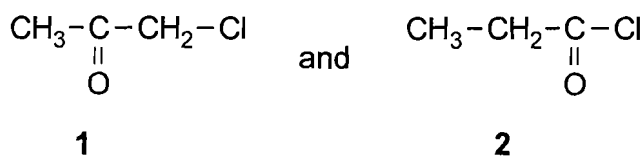

Not only the presence of various structural elements, but also their juxtaposition must be determined to establish the structure of a molecule. Fortunately, spectroscopy often gives valuable information concerning the *connectivity* of structural elements

and in the above example it would be very easy to determine whether there is a ketonic carbonyl group (as in **1**) or an acid chloride (as in **2**). In addition, it is possible to determine independently whether the methyl ( $-\text{CH}_3$ ) and methylene ( $-\text{CH}_2-$ ) groups are separated (as in **1**) or adjacent (as in **2**).

## 1.5 SENSITIVITY

Sensitivity is generally taken to signify the limits of detectability of a chromophore. Some methods (*e.g.*  $^1\text{H}$  NMR) detect all chromophores accessible to them with equal sensitivity while in other techniques (*e.g.* UV) the range of sensitivity towards different chromophores spans many orders of magnitude. In terms of overall sensitivity, *i.e.* the amount of sample required, it is generally observed that:

$$\text{MS} > \text{UV} > \text{IR} > ^1\text{H NMR} > ^{13}\text{C NMR}$$

but considerations of relative sensitivity toward different chromophores may be more important.

## 1.6 PRACTICAL CONSIDERATIONS

The 5 major spectroscopic methods (MS, UV, IR,  $^1\text{H}$  NMR and  $^{13}\text{C}$  NMR) have become established as the principal tools for the determination of the structures of organic compounds, because between them they detect a wide variety of structural elements.

The instrumentation and skills involved in the use of all five major spectroscopic methods are now widely spread, but the ease of obtaining and interpreting the data from each method under real laboratory conditions varies.

In very general terms:

- (a) While the *cost* of each type of instrumentation differs greatly (NMR instruments cost between \$50,000 and several million dollars), as an overall guide, MS and NMR instruments are much more costly than UV and IR spectrometers. With increasing cost goes increasing difficulty in maintenance, thus compounding the total outlay.
- (b) In terms of *ease of usage* for routine operation, most UV and IR instruments are comparatively straightforward. NMR Spectrometers are also common as “hands-on” instruments in most chemistry laboratories but the users require some training, computer skills and expertise. Similarly some Mass Spectrometers are now designed to be used by researchers as “hands-on” routine

instruments. However, the more advanced NMR Spectrometers and most Mass Spectrometers are sophisticated instruments that are usually operated by specialists.

- (c) The *scope* of each method can be defined as the amount of useful information it provides. This is a function not only of the total amount of information obtainable, but also how difficult the data are to interpret. The scope of each method varies from problem to problem and each method has its aficionados and specialists, but the overall utility undoubtedly decreases in the order:

$$\text{NMR} > \text{MS} > \text{IR} > \text{UV}$$

with the combination of  $^1\text{H}$  and  $^{13}\text{C}$  NMR providing the most useful information.

- (d) The theoretical background needed for each method varies with the nature of the experiment, but the minimum overall amount of theory needed decreases in the order:

$$\text{NMR} \gg \text{MS} > \text{UV} \approx \text{IR}$$



## 2

## ULTRAVIOLET (UV) SPECTROSCOPY

## 2.1 BASIC INSTRUMENTATION

Basic instrumentation for both UV and IR spectroscopy consists of an energy *source*, a *sample cell*, a *dispersing device* (prism or grating) and a *detector*, arranged as schematically shown in Figure 2.1.

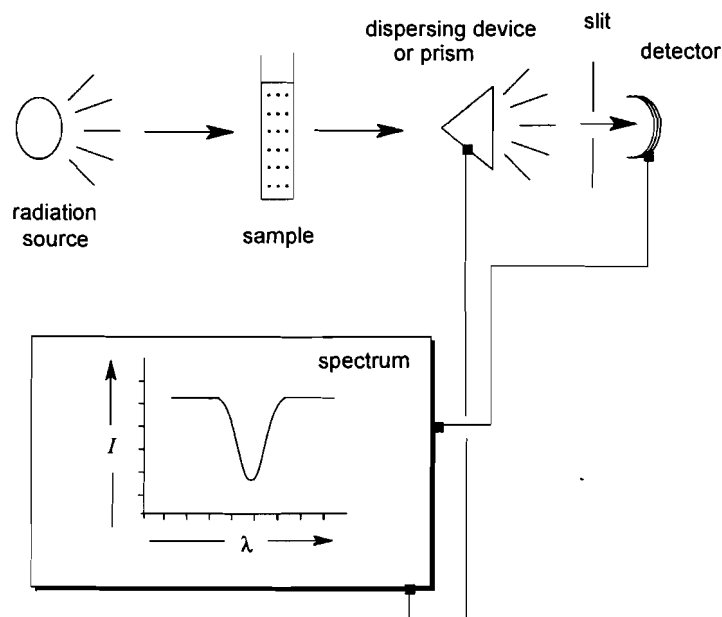

**Figure 2.1** Schematic Representation of an IR or UV Spectrometer

The drive of the dispersing device is synchronised with the x-axis of the recorder or fed directly to a computer, so that this indicates the wavelength of radiation reaching the detector. The signal from the detector is transmitted to the y-axis of the recorder or to a computer and this indicates how much radiation is absorbed by the sample at any particular wavelength.

## Chapter 2 Ultraviolet Spectroscopy

In practice, *double-beam* instruments are used where the absorption of a *reference cell*, containing only solvent, is subtracted from the absorption of the sample cell. Double beam instruments also cancel out absorption due to the atmosphere in the optical path as well as the solvent.

The energy source, the materials from which the dispersing device and the detector are constructed must be appropriate for the range of wavelength scanned and as transparent as possible to the radiation. For UV measurements, the cells and optical components are typically made of quartz and ethanol, hexane, water or dioxan are usually chosen as solvents.

### 2.2 THE NATURE OF ULTRAVIOLET SPECTROSCOPY

The term "UV spectroscopy" generally refers to *electronic transitions* occurring in the region of the electromagnetic spectrum ( $\lambda$  in the range 200-380 nm) accessible to standard UV spectrometers.

Electronic transitions are also responsible for absorption in the visible region (approximately 380-800 nm) which is easily accessible instrumentally but of less importance in the solution of structural problems, because most organic compounds are colourless. An extensive region at wavelengths shorter than  $\sim 200$  nm ("vacuum ultraviolet") also corresponds to electronic transitions, but this region is not readily accessible with standard instruments.

UV spectra used for determination of structures are invariably obtained in solution.

### 2.3 QUANTITATIVE ASPECTS OF ULTRAVIOLET SPECTROSCOPY

The y-axis of a UV spectrum may be calibrated in terms of the intensity of transmitted light (*i.e.* percentage of transmission or absorption), as is shown in Figure 2.2, or it may be calibrated on a logarithmic scale *i.e.* in terms of *absorbance* (A) defined in Figure 2.2.

Absorbance is proportional to concentration and path length (the Beer-Lambert Law). The intensity of absorption is usually expressed in terms of *molar absorbance* or the *molar extinction coefficient* ( $\epsilon$ ) given by:

$$\epsilon = \frac{MA}{Cl}$$

where M is the molecular weight, C the concentration (in grams per litre) and *l* is the path length through the sample in centimetres.

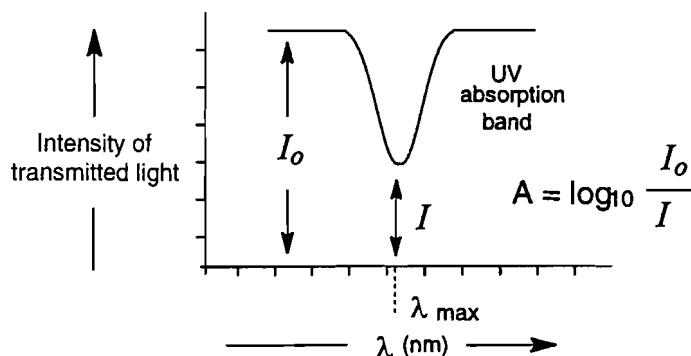
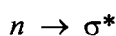
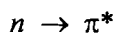
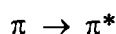
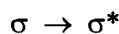

**Figure 2.2** Definition of Absorbance (A)

UV absorption bands (Figure 2.2) are characterised by the wavelength of the absorption maximum ( $\lambda_{\max}$ ) and  $\epsilon$ . The values of  $\epsilon$  associated with commonly encountered chromophores vary between 10 and  $10^5$ . For convenience, extinction coefficients are usually tabulated as  $\log_{10}(\epsilon)$  as this gives numerical values which are easier to manage. The presence of small amounts of strongly absorbing impurities may lead to errors in the interpretation of UV data.

## 2.4 CLASSIFICATION OF UV ABSORPTION BANDS

UV absorption bands have fine structure due to the presence of vibrational sub-levels, but this is rarely observed in solution due to collisional broadening. As the transitions are associated with changes of electron orbitals, they are often described in terms of the orbitals involved, *e.g.*



where  $n$  denotes a non-bonding orbital, the asterisk denotes an antibonding orbital and  $\sigma$  and  $\pi$  have the usual significance.

Another method of classification uses the symbols:

B (for benzenoid)

E (for ethylenic)

R (for radical-like)

K (for conjugated - from the German "konjugierte")

A molecule may give rise to more than one band in its UV spectrum, either because it contains more than one chromophore or because more than one transition of a single chromophore is observed. However, UV spectra typically contain far fewer features (bands) than IR, MS or NMR spectra and therefore have a lower information content. The ultraviolet spectrum of acetophenone in ethanol contains 3 easily observed bands:

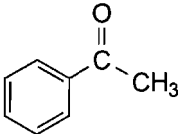
	$\lambda_{\max}$ (nm)	$\epsilon$	$\log_{10}(\epsilon)$	Assignment	
 acetophenone	244	12,600	4.1	$\pi \rightarrow \pi^*$	K
	280	1,600	3.2	$\pi \rightarrow \pi^*$	B
	317	60	1.8	$n \rightarrow \pi^*$	R

## 2.5 SPECIAL TERMS IN UV SPECTROSCOPY

*Auxochromes* (auxiliary chromophores) are groups which have little UV absorption by themselves, but which often have significant effects on the absorption (both  $\lambda_{\max}$  and  $\epsilon$ ) of a chromophore to which they are attached. Generally, auxochromes are atoms with one or more lone pairs *e.g.* -OH, -OR, -NR<sub>2</sub>, -halogen.

If a structural change, such as the attachment of an auxochrome, leads to the absorption maximum being shifted to a longer wavelength, the phenomenon is termed a *bathochromic shift*. A shift towards shorter wavelength is called a *hypsochromic shift*.

## 2.6 IMPORTANT UV CHROMOPHORES

Most of the reliable and useful data is due to relatively strongly absorbing chromophores ( $\epsilon > 200$ ) which are mainly indicative of conjugated or aromatic systems. Examples listed below encompass most of the commonly encountered effects.

(1) *Dienes and Polyenes*

Extension of conjugation in a carbon chain is always associated with a pronounced shift towards longer wavelength, and usually towards greater intensity (Table 2.1).

**Table 2.1 The Effect of Extended Conjugation on UV Absorption**

Alkene	$\lambda_{\max}$ (nm)	$\epsilon$	$\log_{10}(\epsilon)$
$\text{CH}_2=\text{CH}_2$	165	10,000	4.0
$\text{CH}_3-\text{CH}_2-\text{CH}=\text{CH}-\text{CH}_2-\text{CH}_3$ ( <i>trans</i> )	184	10,000	4.0
$\text{CH}_2=\text{CH}-\text{CH}=\text{CH}_2$	217	20,000	4.3
$\text{CH}_3-\text{CH}=\text{CH}-\text{CH}=\text{CH}_2$ ( <i>trans</i> )	224	23,000	4.4
$\text{CH}_2=\text{CH}-\text{CH}=\text{CH}-\text{CH}=\text{CH}_2$ ( <i>trans</i> )	263	53,000	4.7
$\text{CH}_3-(\text{CH}=\text{CH})_5-\text{CH}_3$ ( <i>trans</i> )	341	126,000	5.1

When there are more than 8 conjugated double bonds, the absorption maximum of polyenes is such that they absorb light strongly in the visible region of the spectrum.

Empirical rules (Woodward's Rules) of good predictive value are available to estimate the positions of the absorption maxima in conjugated alkenes and conjugated carbonyl compounds.

The stereochemistry and the presence of substituents also influence UV absorption by the diene chromophore. For example:

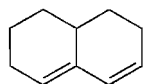

$$\lambda_{\max} = 214 \text{ nm}$$

$$\epsilon = 16,000$$

$$\log_{10}(\epsilon) = 4.2$$



$$\lambda_{\max} = 253 \text{ nm}$$



$$\epsilon = 8,000$$

$$\log_{10}(\epsilon) = 3.9$$

## (2) Carbonyl compounds

All carbonyl derivatives exhibit weak ( $\epsilon < 100$ ) absorption between 250 and 350 nm, and this is only of marginal use in determining structure. However, conjugated carbonyl derivatives always exhibit strong absorption (Table 2.2).

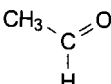
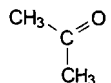
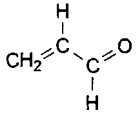
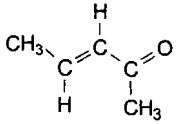
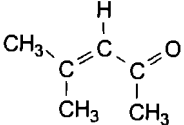
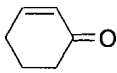
Table 2.2 UV Absorption Bands in Common Carbonyl Compounds

Compound	Structure	$\lambda_{\max}$ (nm)	$\epsilon$	$\log_{10}(\epsilon)$
Acetaldehyde		293 (hexane solution)	12	1.1
Acetone		279 (hexane solution)	15	1.2
Propenal		207 328 (ethanol solution)	12,000 20	4.1 1.3
(E)-Pent-3-en-2-one		221 312 (ethanol solution)	12,000 40	4.1 1.6
4-Methylpent-3-en-2-one		238 316 (ethanol solution)	12,000 60	4.1 1.8
Cyclohex-2-en-1-one		225	7,950	3.9
Benzoquinone		247 292 363	12,600 1,000 250	4.1 3.0 2.4

(3) *Benzene derivatives*

Benzene derivatives exhibit medium to strong absorption in the UV region. Bands usually have characteristic fine structure and the intensity of the absorption is strongly influenced by substituents. Examples listed in Table 2.3 include weak auxochromes (-CH<sub>3</sub>, -Cl, -OCH<sub>3</sub>), groups which increase conjugation (-CH=CH<sub>2</sub>, -C(=O)-R, -NO<sub>2</sub>) and auxochromes whose absorption is pH dependent (-NH<sub>2</sub> and -OH).

**Table 2.3** UV Absorption Bands in Common Benzene Derivatives

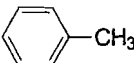
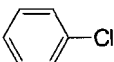
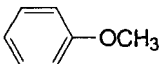
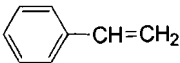
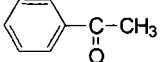
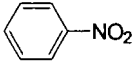
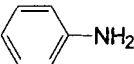
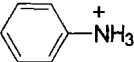
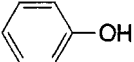
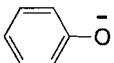
Compound	Structure	$\lambda_{\max}$ (nm)	$\epsilon$	$\log_{10}(\epsilon)$
Benzene		184	60,000	4.8
		204	7,900	3.9
		256	200	2.3
Toluene		208	8,000	3.9
		261	300	2.5
Chlorobenzene		216	8,000	3.9
		265	240	2.4
Anisole		220	8,000	3.9
		272	1,500	3.2
Styrene		244	12,000	4.1
		282	450	2.7
Acetophenone		244	12,600	4.1
		280	1,600	3.2
Nitrobenzene		251	9,000	4.0
		280	1,000	3.0
		330	130	2.1
Aniline		230	8,000	3.9
		281	1,500	3.2
Anilinium ion		203	8,000	3.9
		254	160	2.2
Phenol		211	6,300	3.8
		270	1,500	3.2
Phenoxide ion		235	9,500	4.0
		287	2,500	3.4

Aniline and phenoxide ion have strong UV absorptions due to the overlap of the lone pair on the nitrogen (or oxygen) with the  $\pi$ -system of the benzene ring. This may be expressed in the usual Valence Bond terms:

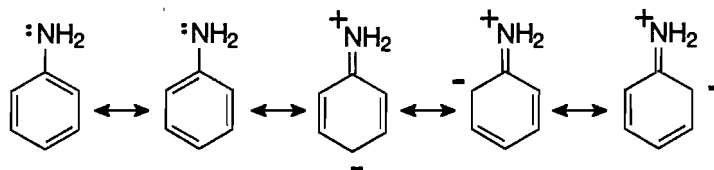

The striking changes in the ultraviolet spectra accompanying protonation of aniline and phenoxide ion are due to loss (or substantial reduction) of the overlap between the lone pairs and the benzene ring.

## 2.7 THE EFFECT OF SOLVENTS

Solvent polarity may affect the absorption characteristics, in particular  $\lambda_{\text{max}}$ , since the polarity of a molecule usually changes when an electron is moved from one orbital to another. Solvent effects of up to 20 nm may be observed with carbonyl compounds. Thus the  $n \rightarrow \pi^*$  absorption of acetone occurs at 279 nm in *n*-hexane, 270 nm in ethanol, and at 265 nm in water.



## 3

## INFRARED (IR) SPECTROSCOPY

---

### 3.1 ABSORPTION RANGE AND THE NATURE OF IR ABSORPTION

Infrared absorption spectra are calibrated in wavelengths expressed in micrometers:

$$1\mu\text{m} = 10^{-6}\text{ m}$$

or in frequency-related *wave numbers* ( $\text{cm}^{-1}$ ) which are reciprocals of wavelengths:

$$\text{wave number } \bar{\nu} \text{ (cm}^{-1}\text{)} = \frac{1 \times 10^4}{\text{wavelength (in } \mu\text{m)}}$$

The range accessible for standard instrumentation is usually:

$$\bar{\nu} = 4000 \text{ to } 666 \text{ cm}^{-1}$$

$$\text{or } \lambda = 2.5 \text{ to } 15 \mu\text{m}$$

Infrared absorption intensities are rarely described quantitatively, except for the general classifications of s (strong), m (medium) or w (weak).

The transitions responsible for IR bands are due to *molecular vibrations*, *i.e.* to periodic motions involving stretching or bending of bonds. Polar bonds are associated with strong IR absorption ***while symmetrical bonds may not absorb at all.***

Clearly the vibrational frequency, *i.e.* the position of the IR bands in the spectrum, depends on the nature of the bond. Shorter and stronger bonds have their stretching vibrations at the higher energy end (shorter wavelength) of the IR spectrum than the longer and weaker bonds. Similarly, bonds to lighter atoms (*e.g.* hydrogen), vibrate at higher energy than bonds to heavier atoms.

IR bands often have rotational sub-structure, but this is normally resolved only in spectra taken in the gas phase.

### 3.2 EXPERIMENTAL ASPECTS OF INFRARED SPECTROSCOPY

The basic layout of a simple dispersive IR spectrometer is the same as for an UV spectrometer (Figure 2.1), except that all components must now match the different energy range of electromagnetic radiation. The more sophisticated Fourier Transform Infrared (FTIR) instruments record an infrared interference pattern generated by a moving mirror and this is transformed by a computer into an infrared spectrum.

Very few substances are transparent over the whole of the IR range: sodium and potassium chloride and sodium and potassium bromide are most common. The cells used for obtaining IR spectra in solution typically have NaCl windows and liquids can be examined as films on NaCl plates. Solution spectra are generally obtained in chloroform or carbon tetrachloride but this leads to loss of information at longer wavelengths where there is considerable absorption of energy by the solvent. Organic solids may also be examined as mulls (fine suspensions) in heavy oils. The oils absorb infrared radiation but only in well-defined regions of the IR spectrum. Solids may also be examined as dispersions in compressed KBr or KCl discs.

To a first approximation, the absorption frequencies due to the important IR chromophores are the same in solid and liquid states.

### 3.3 GENERAL FEATURES OF INFRARED SPECTRA

Almost all organic compounds contain C-H bonds and this means that there is invariably an absorption band in the IR spectrum between 2900 and 3100  $\text{cm}^{-1}$  at the C-H stretching frequency.

Molecules generally have a large number of bonds and each bond may have several IR-active *vibrational modes*. IR spectra are complex and have many overlapping absorption bands. IR spectra are sufficiently complex that the spectrum for each compound is unique and this makes IR spectra very useful for identifying compounds by direct comparison with spectra from authentic samples ("*fingerprinting*").

The characteristic IR vibrations are influenced strongly by small changes in molecular structure, thus making it difficult to identify structural fragments from IR data alone. However, there are some groups of atoms that are readily recognised from IR spectra. IR chromophores are most useful for the determination of structure if:

- (a) The chromophore does not absorb in the *most crowded region* of the spectrum (600-1400  $\text{cm}^{-1}$ ) where strong overlapping stretching absorptions from C-X single bonds (X = O, N, S, P and halogens) make assignment difficult.

- (b) The chromophores should be *strongly absorbing* to avoid confusion with weak harmonics. However, in otherwise empty regions *e.g.* 1800-2500  $\text{cm}^{-1}$ , even weak absorptions can be assigned with confidence.
- (c) The absorption frequency must be structure dependent in an *interpretable* manner. This is particularly true of the very important bands due to the C=O stretching vibrations, which generally occur between 1630 and 1850  $\text{cm}^{-1}$ .

### 3.4 IMPORTANT IR CHROMOPHORES

(1)	<b>-O-H Stretch</b>	Not hydrogen-bonded ("free")	3600 $\text{cm}^{-1}$
		Hydrogen-bonded	3100 - 3200 $\text{cm}^{-1}$

This difference between hydrogen bonded and free OH frequencies is clearly related to the weakening of the O-H bond as a consequence of hydrogen bonding.

(2) **Carbonyl groups** always give rise to **strong** absorption between 1630 and 1850  $\text{cm}^{-1}$  due to C=O stretching vibrations. Moreover, carbonyl groups in different functional groups are associated with well-defined regions of IR absorption (Table 3.1).

Even though the ranges for individual types often overlap, it may be possible to make a definite decision from information derived from other regions of the IR spectrum. Thus esters also exhibit strong C-O stretching absorption between 1200 and 1300  $\text{cm}^{-1}$  while carboxylic acids exhibit O-H stretching absorption generally near 3000  $\text{cm}^{-1}$ .

The characteristic shift toward lower frequency associated with the introduction of  $\alpha$ ,  $\beta$ -unsaturation can be rationalised by considering the Valence Bond description of an enone:

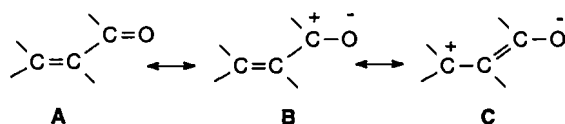

The additional structure C, which cannot be drawn for an unconjugated carbonyl derivative, implies that the carbonyl band in an enone has more single bond character and is therefore weaker. The involvement of a carbonyl group in hydrogen bonding reduces the frequency of the carbonyl stretching vibration by about 10  $\text{cm}^{-1}$ . This can be rationalised in a manner analogous to that proposed above for free and H-bonded O-H vibrations.

**Table 3.1 Carbonyl (C=O) IR Absorption Frequencies in Common Functional Groups**

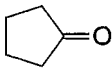
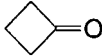
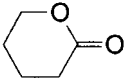
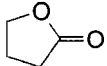
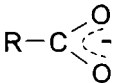
Carbonyl group	Structure	$\bar{\nu}$ (cm <sup>-1</sup> )
Ketones	$\text{R}-\overset{\text{O}}{\parallel}{\text{C}}-\text{R}'$	1700 - 1725
Aldehydes	$\text{R}-\overset{\text{O}}{\parallel}{\text{C}}-\text{H}$	1720 - 1740
Aryl aldehydes or ketones, $\alpha, \beta$ -unsaturated aldehydes or ketones	$\text{Ar}-\overset{\text{O}}{\parallel}{\text{C}}-\text{R}'$ $\text{R}-\text{CH}=\text{CH}-\overset{\text{O}}{\parallel}{\text{C}}-\text{R}'$ $\text{R}' = \text{alkyl, aryl, or H}$	1660 - 1715
Cyclopentanones		1740 - 1750
Cyclobutanones		1760 - 1780
Carboxylic acids	$\text{R}-\overset{\text{O}}{\parallel}{\text{C}}-\text{OH}$	1700 - 1725
$\alpha, \beta$ -unsaturated and aryl carboxylic acids	$\text{Ar}-\overset{\text{O}}{\parallel}{\text{C}}-\text{OH}$ $\text{R}-\text{CH}=\text{CH}-\overset{\text{O}}{\parallel}{\text{C}}-\text{OH}$	1680 - 1715
Esters §	$\text{R}-\overset{\text{O}}{\parallel}{\text{C}}-\text{OR}'$	1735 - 1750
Phenolic Esters §	$\text{R}-\overset{\text{O}}{\parallel}{\text{C}}-\text{OAr}$	1760 - 1800
Aryl or $\alpha, \beta$ -unsaturated Esters §	$\text{R}-\text{CH}=\text{CH}-\overset{\text{O}}{\parallel}{\text{C}}-\text{OR}'$ $\text{Ar}-\overset{\text{O}}{\parallel}{\text{C}}-\text{OR}'$	1715 - 1730
$\delta$ -Lactones §		1735 - 1750
$\gamma$ -Lactones §		1760 - 1780
Amides	$\text{R}-\overset{\text{O}}{\parallel}{\text{C}}-\text{NR}'\text{R}''$	1630 - 1690
Acid chlorides	$\text{R}-\overset{\text{O}}{\parallel}{\text{C}}-\text{Cl}$	1785 - 1815
Acid anhydrides (two bands)	$\text{R}-\overset{\text{O}}{\parallel}{\text{C}}-\text{O}-\overset{\text{O}}{\parallel}{\text{C}}-\text{R}$	1740 - 1850
Carboxylates		1550 - 1610 1300 - 1450

§ Esters and lactones also exhibit a strong C-O stretch in the range 1160 - 1250 cm<sup>-1</sup>

(3) **Other polar functional groups.** Many functional groups have characteristic IR absorptions (Table 3.2). These are particularly useful for groups that do not contain magnetic nuclei and are thus not readily identified by NMR spectroscopy.

**Table 3.2 Characteristic IR Absorption Frequencies for Common Functional Groups**

Functional group	Structure	$\bar{\nu}$ (cm <sup>-1</sup> )	Intensity
Amine		3300 - 3500	
Terminal acetylenes	$\equiv\text{C}-\text{H}$	3300	strong
Imines		1480 - 1690	
Enol ethers		1600 - 1660	strong
Alkenes		1640 - 1680	weak to medium
Nitro groups		1500 - 1650	strong
		1250 - 1400	medium
Sulfoxides		1010 - 1070	strong
Sulfones		1300 - 1350	strong
		1100 - 1150	strong
Sulfonamides and Sulfonate esters		1140 - 1180	strong
		1300 - 1370	strong
Alcohols		1000 - 1260	strong
Ethers		1085 - 1150	strong
Alkyl fluorides		1000 - 1400	strong
Alkyl chlorides		580 - 780	strong
Alkyl bromides		560 - 800	strong
Alkyl iodides		500 - 600	strong

Carbon-carbon double bonds in unconjugated alkenes usually exhibit weak to moderate absorptions due to C=C stretching in the range 1660-1640  $\text{cm}^{-1}$ .

Disubstituted, trisubstituted and tetrasubstituted alkenes usually absorb near 1670  $\text{cm}^{-1}$ . The more polar carbon-carbon double bonds in enol ethers and enones usually absorb strongly between 1600 and 1700  $\text{cm}^{-1}$ . Alkenes conjugated with an aromatic ring absorb strongly near 1625  $\text{cm}^{-1}$ .

(4) *Chromophores absorbing in the region between 1900 and 2600  $\text{cm}^{-1}$ .* The absorptions listed in Table 3.3 often yield useful information because, even though some are of only weak or medium intensity, they occur in regions largely devoid of absorption by other commonly occurring chromophores.

**Table 3.3 IR Absorption Frequencies in the Region 1900 – 2600  $\text{cm}^{-1}$**

Functional group	Structure	$\bar{\nu}$ ( $\text{cm}^{-1}$ )	Intensity
Alkyne	$-\text{C}\equiv\text{C}-$	2100 - 2300	weak to medium
Nitrile	$-\text{C}\equiv\text{N}$	~ 2250	medium
Cyanate	$-\text{N}=\text{C}=\text{O}$	~ 2270	strong
Isocyanate	$-\text{N}=\text{C}=\text{O}$	2200 - 2300	strong
Thiocyanate	$-\text{N}=\text{C}=\text{S}$	~ 2150 (broad)	strong
Allene	$\begin{array}{c} \diagdown \quad \diagup \\ \text{C}=\text{C}=\text{C} \\ \diagup \quad \diagdown \end{array}$	~ 1950	strong

## 4

## MASS SPECTROMETRY

It is possible to determine the masses of individual ions in the gas phase. Strictly speaking, it is only possible to measure their mass/charge ratio ( $m/e$ ), but as multi charged ions are very much less abundant than those with a single electronic charge ( $e = 1$ ),  $m/e$  is for all practical purposes equal to the mass of the ion,  $m$ . The principal experimental problems in mass spectrometry are firstly to volatilise the substrate (which implies high vacuum) and secondly to ionise the neutral molecules to charged species.

## 4.1 IONISATION PROCESSES

The most common method of ionisation involves *Electron Impact* (EI) and there are two general courses of events following a collision of a molecule M with an electron  $e$ . By far the most probable event involves electron ejection which yields an odd-electron positively charged *cation radical*  $[M]^{\cdot+}$  of the same mass as the initial molecule M.

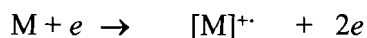

The cation radical produced is known as the *molecular ion* and its mass gives a direct measure of the molecular weight of a substance. An alternative, far less probable process, also takes place and it involves the capture of an electron to give a negative *anion radical*,  $[M]^{\cdot-}$ .

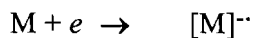

Electron impact mass spectrometers are generally set up to detect only positive ions, but negative-ion mass spectrometry is also possible.

The energy of the electron responsible for the ionisation process can be varied. It must be sufficient to knock out an electron and this threshold, typically about 10-12 eV, is known as the *appearance potential*. In practice much higher energies ( $\sim 70$  eV) are used and this large excess energy ( $1 \text{ eV} = 95 \text{ kJ mol}^{-1}$ ) causes further *fragmentation* of the molecular ion.

The magnetic scan is synchronised with the x-axis of a recorder and calibrated to appear as *mass number* (strictly  $m/e$ ). The amplified current from the ion collector gives the relative abundance of ions on the y-axis. The signals are usually pre-processed by a computer that assigns a relative abundance of 100% to the strongest peak (*base peak*).

Many modern mass spectrometers do not use a magnet to bend the ion beam to separate ions but rather use the "*time of flight*" (TOF) of an ion over a fixed distance to measure its mass. In these spectrometers, ions are generated (usually using a very short laser pulse) then accelerated in an electric field. Lighter ions have a higher velocity as they leave the accelerating field and their time of flight over a fixed distance will vary depending on the speed that they are travelling. Time of Flight mass spectrometers have the advantage that they do not require large, high-precision magnets to bend and disperse the ion beam so they tend to be much smaller, compact and less complex (desk-top size) instruments.

### 4.3 MASS SPECTRAL DATA

As well as giving the molecular weight of a substance, the molecular ion of a compound may provide additional information. The "**nitrogen rule**" states that a molecule with an even molecular weight must contain no nitrogen atoms or an even number of nitrogen atoms. This means that a molecule with an odd molecular weight must contain an odd number of nitrogen atoms.

(1) **High resolution mass spectra.** The **mass of an ion** is routinely determined to the nearest unit value. Thus the mass of  $[M]^+$  gives a direct measure of molecular weight. It is not usually possible to assign a molecular formula to a compound on the basis of the integer  $m/e$  value of its parent ion. For example, a parent ion at  $m/e$  72 could be due to a compound whose molecular formula is  $C_4H_8O$  or one with a molecular formula  $C_3H_4O_2$  or one with a molecular formula  $C_3H_8N_2$ .

However, using a *double-focussing* mass spectrometer or a *time-of-flight* mass spectrometer, the mass of an ion or any fragment can be determined to an accuracy of approximately  $\pm 0.00001$  of a mass unit (*a high resolution mass spectrum*). Since the masses of the atoms of each element are known to high accuracy, molecules that may have the same mass when measured only to the nearest integer mass unit, can be distinguished when the mass is measured with high precision. Based on the accurate masses of  $^{12}C$ ,  $^{16}O$ ,  $^{14}N$  and  $^1H$  (Table 4.1) ions with the formulas  $C_4H_8O^+$ ,  $C_3H_4O_2^+$  or  $C_3H_8N_2^+$  would have accurate masses 72.0573, 72.0210, and 72.0686 so these



## 4.2 INSTRUMENTATION

In a magnetic sector mass spectrometer (Figure 4.1), the positively charged ions of mass,  $m$ , and charge,  $e$  (generally  $e = 1$ ) are subjected to an accelerating voltage  $V$  and passed through a magnetic field  $H$  which causes them to be deflected into a curved path of radius  $r$ . The quantities are connected by the relationship:

$$\frac{m}{e} = \frac{H^2 r^2}{2V}$$

The values of  $H$  and  $V$  are known,  $r$  is determined experimentally and  $e$  is assumed to be unity thus permitting us to determine the mass  $m$ . In practice the magnetic field is scanned so that streams of ions of different mass pass sequentially to the detecting system (ion collector). The whole system (Figure 4.1) is under high vacuum (less than  $10^{-6}$  Torr) to permit the volatilisation of the sample and so that the passage of ions is not impeded. The introduction of the sample into the ion chamber at high vacuum requires a complex sample inlet system.

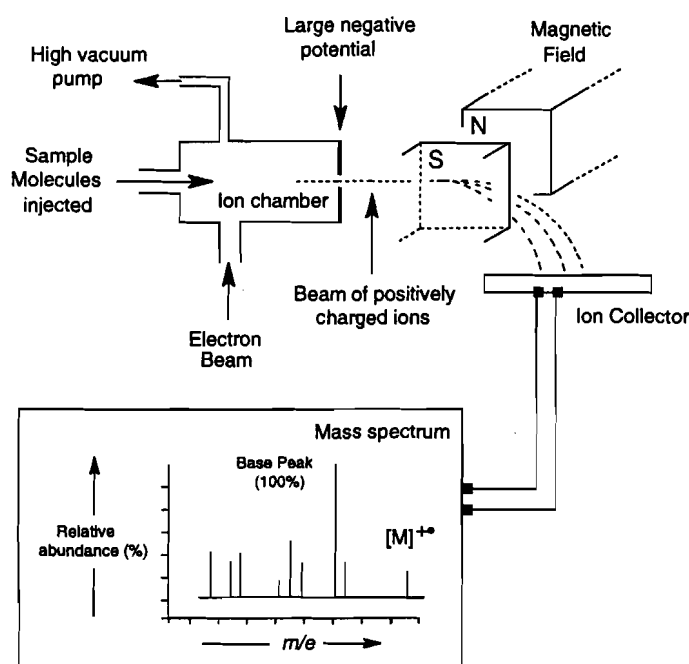
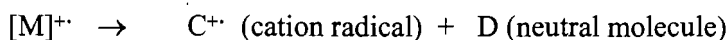

Figure 4.1 Schematic Diagram of an Electron-Impact Mass Spectrometer

The two important types of fragmentation are:



or



As only species bearing a positive charge will be detected, the mass spectrum will show signals due not only to  $[M]^{+\cdot}$  but also due to  $A^+$ ,  $C^{+\cdot}$  and to fragment ions resulting from subsequent fragmentation of  $A^+$  and  $C^{+\cdot}$ .

As any species may fragment in a variety of ways, the typical mass spectrum consists of many signals. The mass spectrum consists of a plot of masses of ions against their relative abundance.

There are a number of other methods for ionising the sample in a mass spectrometer. The most important alternative ionisation method to electron impact is *Chemical Ionisation* (CI). In CI mass spectrometry, an intermediate substance (generally methane or ammonia) is introduced at a higher concentration than that of the substance being investigated. The carrier gas is ionised by electron impact and the substrate is then ionised by collisions with these ions. CI is a milder ionisation method than EI and leads to less fragmentation of the molecular ion.

Another common method of ionisation is *Electrospray Ionisation* (ES). In this method, the sample is dissolved in a polar, volatile solvent and pumped through a fine metal nozzle, the tip of which is charged with a high voltage. This produces charged droplets from which the solvent rapidly evaporates to leave naked ions which pass into the mass spectrometer. ES is also a relatively mild form of ionisation and is very suitable for biological samples which are usually quite soluble in polar solvent but which are relatively difficult to vaporise in the solid state. Electrospray ionisation tends to lead to less fragmentation of the molecular ion than EI.

*Matrix Assisted Laser Desorption Ionisation* (MALDI) uses a pulse of laser light to bring about ionisation. The sample is usually mixed with a highly absorbing compound which acts as a supporting matrix. The laser pulse ionises and vaporises the matrix and the sample to give ions which pass into the mass spectrometer. Again MALDI is a relatively mild form of ionisation which tends to give less fragmentation of the molecular ion than EI.

All of the subsequent discussion of mass spectrometry is limited to positive-ion electron-impact mass spectrometry.

could easily be distinguished by high resolution mass spectroscopy. In general, if the mass of any fragment in the mass spectrum can be accurately determined, there is usually only one combination of elements which can give rise to that signal since there are only a limited number of elements and their masses are accurately known. By examining a mass spectrum at sufficiently high resolution, one can obtain the exact composition of *each ion* in a mass spectrum, unambiguously. Most importantly, determining the accurate mass of  $[M]^+$  gives the molecular formula of the compound.

**Table 4.1** Accurate Masses of Selected Isotopes

Isotope	Natural Abundance (%)	Mass
$^1\text{H}$	99.98	1.00783
$^{12}\text{C}$	98.9	12.0000
$^{13}\text{C}$	1.1	13.00336
$^{14}\text{N}$	99.6	14.0031
$^{16}\text{O}$	99.8	15.9949
$^{19}\text{F}$	100.0	18.99840
$^{31}\text{P}$	100.0	30.97376
$^{32}\text{S}$	95.0	31.9721
$^{33}\text{S}$	0.75	32.9715
$^{34}\text{S}$	4.2	33.9679
$^{35}\text{Cl}$	75.8	34.9689
$^{37}\text{Cl}$	24.2	36.9659
$^{79}\text{Br}$	50.7	78.9183
$^{81}\text{Br}$	49.3	80.9163

(2) **Isotope ratios.** For some elements (most notably bromine and chlorine), there exists more than one isotope of high natural abundance *e.g.* bromine has two abundant isotopes -  $^{79}\text{Br}$  49 % and  $^{81}\text{Br}$  51 %; chlorine also has two abundant isotopes-  $^{37}\text{Cl}$  25 % and  $^{35}\text{Cl}$  75% (Table 4.1). The presence of Br or Cl or other elements that contain significant proportions ( $\geq 1\%$ ) of minor isotopes is often obvious simply by inspection of ions near the molecular ion.

The relative intensities of the  $[M]^+$ ,  $[M+1]^+$  and  $[M+2]^+$  ions exhibit a characteristic pattern depending on the elements that make up the ion. For any molecular ion (or fragment) which contains one bromine atom, the mass spectrum will contain two

peaks separated by two  $m/e$  units, one for the ions which contain  $^{79}\text{Br}$  and one for the ions which contain  $^{81}\text{Br}$ . For bromine-containing ions, the relative intensities of the two ions will be approximately the same since the natural abundances of  $^{79}\text{Br}$  and  $^{81}\text{Br}$  are approximately equal. Similarly, for any molecule (or fragment of a molecule) which contains one chlorine atom, the mass spectrum will contain two fragments separated by two  $m/e$  units, one for the ions which contain  $^{35}\text{Cl}$  and one for the ions which contain  $^{37}\text{Cl}$ . For chlorine-containing ions, the relative intensities of the two ions will be approximately the 3:1 since this reflects the natural abundances of  $^{35}\text{Cl}$  and  $^{37}\text{Cl}$ .

Any molecular ion (or fragment) which contains 2 bromine atoms will have a pattern of  $M:M+2:M+4$  with signals in the ratio 1:3:1 and any molecular ion (or fragment) which contains 2 chlorine atoms will have a pattern of  $M:M+2:M+4$  with signals in the ratio 10:6:1.

**(3) Molecular Fragmentation.** The **fragmentation pattern** is a molecular fingerprint. In addition to the molecular ion peak, the mass spectrum (see Figure 4.1) consists of a number of peaks at lower mass number and these result from fragmentation of the molecular ion. The principles determining the mode of fragmentation are reasonably well understood, and it is possible to derive structural information from the fragmentation pattern in several ways.

- (a) The appearance of prominent peaks at certain mass numbers can be correlated empirically with certain structural elements (Table 4.2), *e.g.* a prominent peak at  $m/e = 43$  is a strong indication of the presence of a  $\text{CH}_3\text{-CO-}$  group in the molecule.
- (b) Information can also be obtained from *differences* between the masses of two peaks. Thus a prominent fragment ion that occurs 15 mass numbers below the molecular ion, suggests strongly the loss of a  $\text{CH}_3\text{-}$  group and therefore that a methyl group was present in the substance examined.
- (c) The knowledge of the principles governing the **mode of fragmentation** of ions makes it possible to confirm the structure assigned to a compound and, quite often, to determine the juxtaposition of structural fragments and to distinguish between isomeric substances. For example, the mass spectrum of benzyl methyl ketone,  $\text{Ph-CH}_2\text{-CO-CH}_3$  contains a strong peak at  $m/e = 91$  due to the stable ion  $\text{Ph-CH}_2^+$ , but this ion is absent in the mass spectrum of the isomeric propiophenone  $\text{Ph-CO-CH}_2\text{CH}_3$  where the structural elements  $\text{Ph-}$  and  $\text{-CH}_2\text{-}$  are separated. Instead, a prominent peak occurs at  $m/e = 105$  due to the stable ion  $\text{Ph-C}\equiv\text{O}^+$ .

Electronic databases of the mass spectral fragmentation patterns of known molecules can be rapidly searched by computer. The pattern and intensity of fragments in the mass spectrum is characteristic of an individual compound so comparison of the experimental mass spectrum of a compound with those in a library can be used to positively identify it, if its spectrum has been recorded previously.

**Table 4.2 Common Fragments and their Masses**

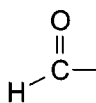
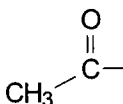
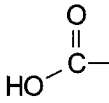
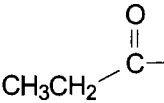
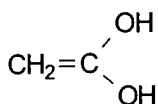
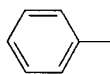
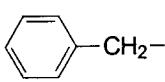
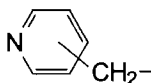
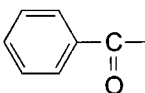
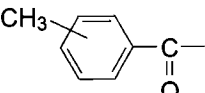
Fragment	Mass	Fragment	Mass	Fragment	Mass
$\text{CH}_3-$	15	$\text{CH}_3\text{CH}_2-$	29		29
NO	30	$-\text{CH}_2\text{OH}$	31	$\text{CH}_2=\text{CH}-\text{CH}_2$	41
	43		45	$-\text{NO}_2$	46
$\text{C}_4\text{H}_7$	55	$\text{C}_4\text{H}_9$	57		57
	60	$\text{C}_5\text{H}_5$	65	 $\text{C}_6\text{H}_5$	77
 $\text{C}_7\text{H}_7$	91	 $\text{C}_6\text{H}_6\text{N}$	92	 $\text{C}_7\text{H}_5\text{O}$	105
 $\text{C}_8\text{H}_7\text{O}$	119	I—	127		

It is now common to couple an instrument for separating a mixture of organic compounds *e.g.* using gas chromatography (GC) or high performance liquid chromatography (HPLC), directly to the input of a mass spectrometer. In this way, as each individual compound is separated from the mixture, its mass spectrum can be recorded and compared automatically with the library of known compounds and identified immediately if it is a known compound.

(4) *Meta-stable peaks* in a mass spectrum arise if the fragmentation process

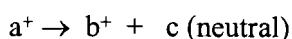

takes place within the ion-accelerating region of the mass spectrometer (Figure 4.1). Ion peaks corresponding to the masses of  $a^+$  and to  $b^+$  ( $m_a$  and  $m_b$ ) may be accompanied by a broader peak at mass  $m^*$ , such that:

$$m^* = \frac{m_b^2}{m_a}$$

This often permits positive identification of a particular fragmentation path.

#### 4.4 REPRESENTATION OF FRAGMENTATION PROCESSES

As fragmentation reactions in a mass spectrometer involve the breaking of bonds, they can be represented by the standard "arrow notation" used in organic chemistry. For some purposes a radical cation (*e.g.* a generalised ion of the molecular ion) can be represented without attempting to localise the missing electron:

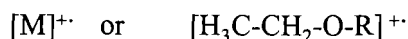

However, to show a fragmentation process it is generally necessary to indicate "from where the electron is missing" even though no information about this exists. In the case of the molecular ion corresponding to an alkyl ethyl ether, it can be reasonably inferred that the missing electron resided on the oxygen. The application of standard arrow notation permits us to represent a commonly observed process, *viz.* the loss of a methyl fragment from the  $[H_3C-CH_2-O-R]^{\cdot+}$  molecular ion:

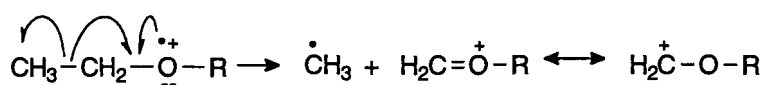

## 4.5 FACTORS GOVERNING FRAGMENTATION PROCESSES

Three factors dominate the fragmentation processes:

- Weak bonds** tend to be broken most easily
- Stable fragments** (not only ions, but also the accompanying radicals and molecules) tend to be formed most readily
- Some fragmentation processes depend on the ability of molecules to assume cyclic transition states.

Favourable fragmentation processes naturally occur more often and ions thus formed give rise to strong peaks in the mass spectrum.

## 4.6 EXAMPLES OF COMMON TYPES OF FRAGMENTATION

There are a number of common types of cleavage which are characteristic of various classes of organic compounds. These result in the loss of well-defined fragments which are characteristic of certain functional groups or structural elements.

(1) **Cleavage at Branch Points.** Cleavage of aliphatic carbon skeletons at branch points is favoured as it leads to more substituted (and hence more stable) carbocations. The mass spectrum of 2,2-dimethylpentane shows strong peaks at  $m/e = 85$  and  $m/e = 57$  where cleavage leads to the formation of stable tertiary carbocations.

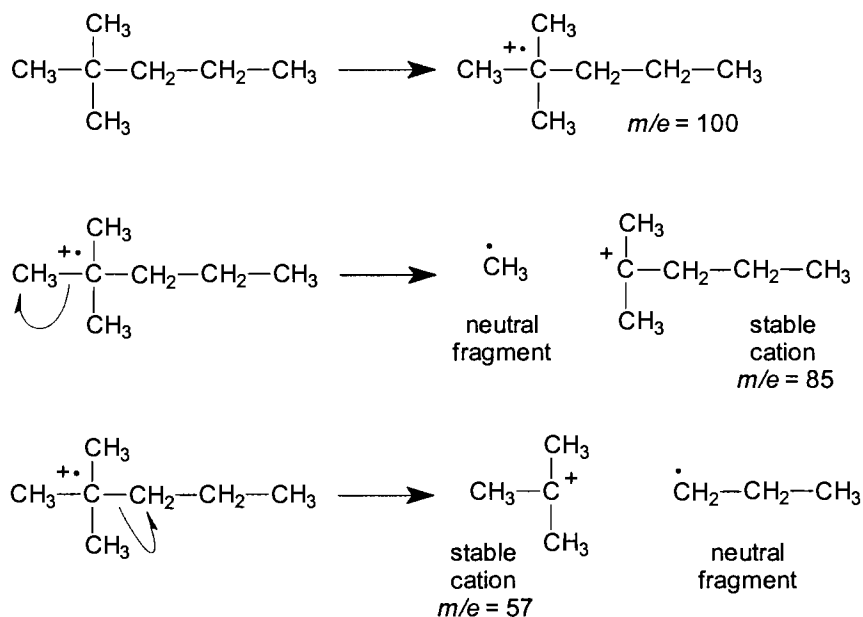

- (2)  **$\beta$ -Cleavage.** Chain cleavage tends to occur  $\beta$  to heteroatoms, double bonds and aromatic rings because relatively stable, delocalised carbocations result in each case.

(a)

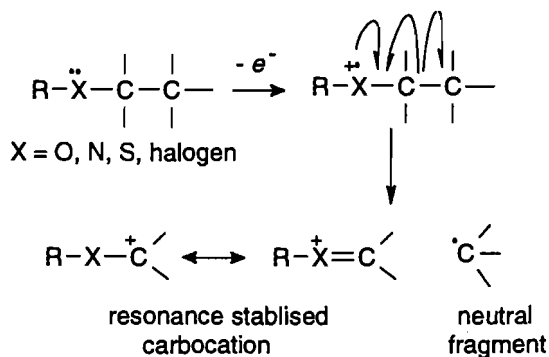

(b)

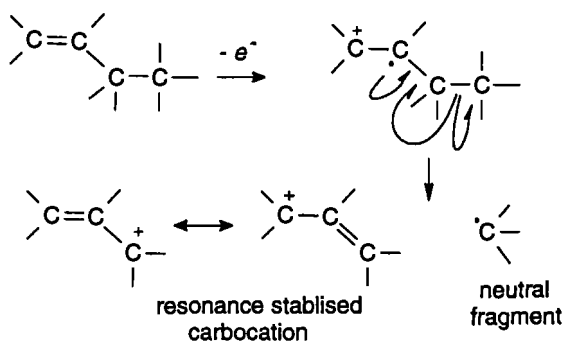

(c)

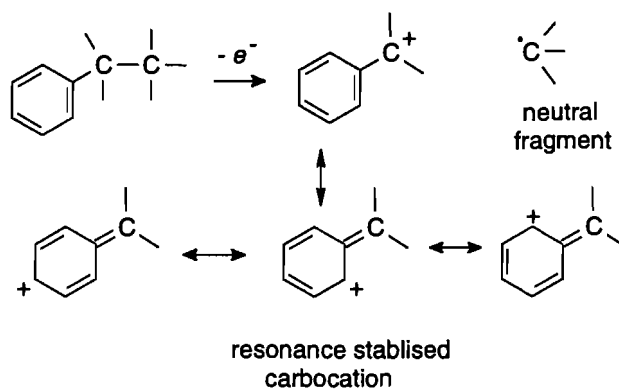



(3) **Cleavage  $\alpha$  to carbonyl groups.** Cleavage tends to occur  $\alpha$  to carbonyl groups to give stable acylium cations. R may be an alkyl, -OH or -OR group.

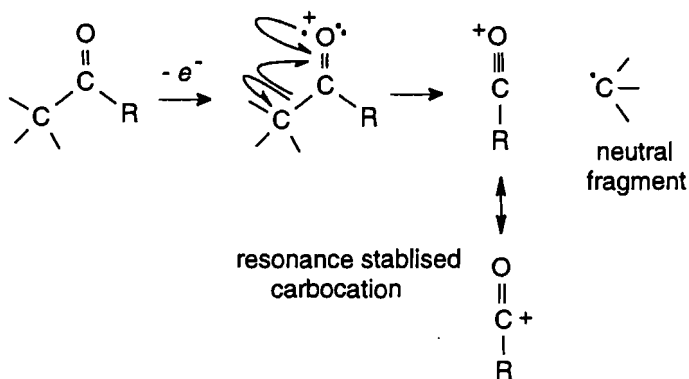

(4) **Cleavage  $\alpha$  to heteroatoms.** Cleavage of chains may also occur  $\alpha$  to heteroatoms, e.g. in the case of ethers:

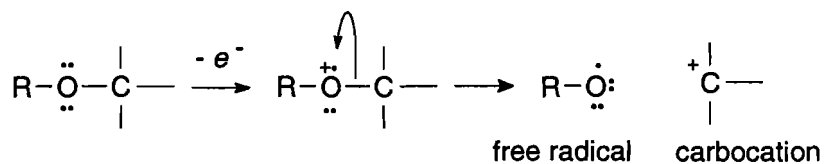

(5) **retro Diels-Alder reaction.** Cyclohexene derivatives may undergo a retro Diels-Alder reaction:

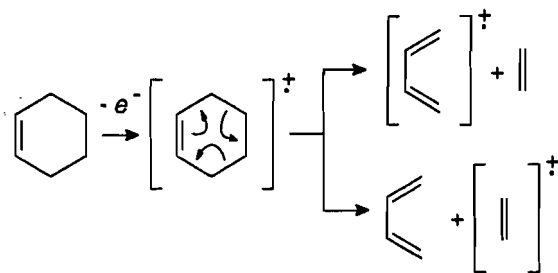

(6) **The McLafferty rearrangement.** Compounds where the molecular ion can assume the appropriate 6-membered cyclic transition state usually undergo a cyclic fragmentation, known as the **McLafferty rearrangement**. This rearrangement involves a transfer of a  $\gamma$  hydrogen atom to an oxygen and is often observed with ketones, acids and esters:

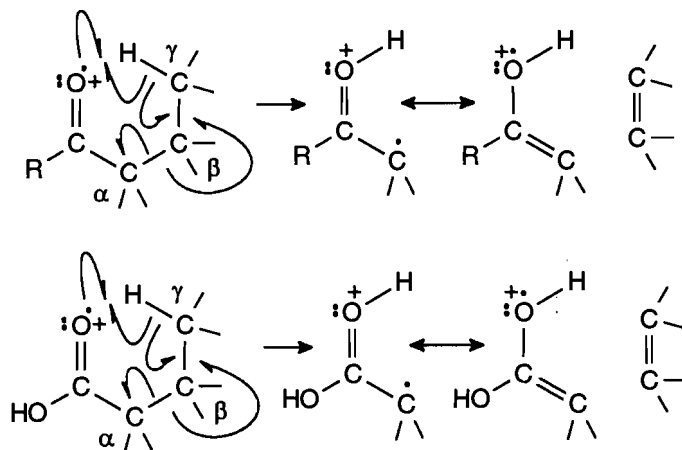

With primary carboxylic acids,  $R-CH_2-COOH$ , this fragmentation leads to a characteristic peak at  $m/e = 60$

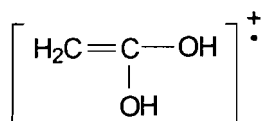

With carboxylic esters, two types of McLafferty rearrangements may be observed and ions resulting from either fragmentation pathway are observed in the mass spectrum:

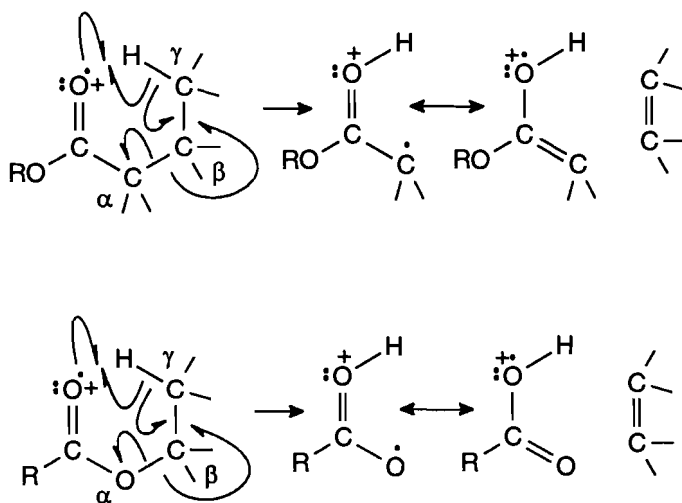

# 5

## NUCLEAR MAGNETIC RESONANCE (NMR) SPECTROSCOPY

---

### 5.1 THE PHYSICS OF NUCLEAR SPINS AND NMR INSTRUMENTS

#### (1) *The Larmor Equation and Nuclear Magnetic Resonance*

All nuclei have charge because they contain protons and some of them also behave as if they spin. A spinning charge generates a magnetic dipole and is associated with a small magnetic field  $\mathbf{H}$  (Figure 5.1). Such nuclear magnetic dipoles are characterised by nuclear magnetic **spin quantum numbers** which are designated by the letter  $\mathbf{I}$  and can take up values equal to 0,  $1/2$ ,  $1, 3/2$  ... etc.

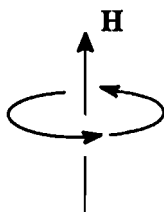

**Figure 5.1** A spinning positive charge generates a magnetic field and behaves like a small magnet

It is useful to consider three types of nuclei:

**Type 1:** Nuclei with  $\mathbf{I} = 0$ . These nuclei do not interact with the applied magnetic field and **are not NMR chromophores**. Nuclei with  $\mathbf{I} = 0$  have an even number of protons and even number of neutrons and have no net spin. This means that nuclear spin is a property characteristic of certain **isotopes** rather than of certain elements. The most prominent examples of nuclei with  $\mathbf{I} = 0$  are  $^{12}\text{C}$  and  $^{16}\text{O}$ , the dominant isotopes of carbon and oxygen. Both oxygen and carbon also have isotopes that can be observed by NMR spectroscopy.

- Type 2:** Nuclei with  $I = 1/2$ . These nuclei have a non-zero magnetic moment and are NMR visible and have no nuclear electric quadrupole (Q). The two most important nuclei for NMR spectroscopy belong to this category:  $^1\text{H}$  (ordinary hydrogen) and  $^{13}\text{C}$  (a non-radioactive isotope of carbon occurring to the extent of 1.06% at natural abundance). Also, two other commonly observed nuclei  $^{19}\text{F}$  and  $^{31}\text{P}$  have  $I = 1/2$ . Together, NMR data for  $^1\text{H}$  and  $^{13}\text{C}$  account for well over 90% of all NMR observations in the literature and the discussion and examples in this book all refer to these two nuclei. However, the spectra of all nuclei with  $I = 1/2$  can be understood easily on the basis of common theory.
- Type 3:** Nuclei with  $I > 1/2$ . These nuclei have both a magnetic moment and an electric quadrupole. This group includes some common isotopes (*e.g.*  $^2\text{H}$  and  $^{14}\text{N}$ ) but they are more difficult to observe and spectra are generally very broad. This group of nuclei will not be discussed further.

The most important consequence of nuclear spin is that in a uniform magnetic field, a nucleus of spin  $I$  may assume  $2I + 1$  orientations. For nuclei with  $I = 1/2$ , there are just 2 permissible orientations (since  $2 \times 1/2 + 1 = 2$ ). These two orientations will be of unequal energy (by analogy with the parallel and antiparallel orientations of a bar magnet in a magnetic field) and it is possible to induce a spectroscopic transition (spin-flip) by the absorption of a quantum of electromagnetic energy ( $\Delta E$ ) of the appropriate frequency ( $\nu$ ):

$$\nu = \frac{\Delta E}{h} \quad (5.1)$$

In the case of NMR, the energy required to induce the nuclear spin flip also depends on the strength of the applied field,  $H_0$ . It is found that

$$\nu = K H_0 \quad (5.2)$$

where  $K$  is a constant characteristic of the nucleus observed. Equation 5.2 is known as the **Larmor equation** and is the fundamental relationship in NMR spectroscopy. Unlike other forms of spectroscopy, in NMR the frequency of the absorbed electromagnetic radiation is not an absolute value for any particular transition, but has a different value depending on the strength of the applied magnetic field. For every value of  $H_0$ , there is a matching value of  $\nu$  corresponding to the condition of *resonance* according to Equation 5.2, and this is the origin of the term *Resonance* in Nuclear Magnetic Resonance Spectroscopy. Thus for  $^1\text{H}$  and  $^{13}\text{C}$ , *resonance*

frequencies corresponding to magnitudes of applied magnetic field ( $H_o$ ) commonly found in commercial instruments are given in Table 5.1.

**Table 5.1 Resonance Frequencies of  $^1\text{H}$  and  $^{13}\text{C}$  Nuclei in Magnetic Fields of Different Strengths**

$\nu$ $^1\text{H}$ (MHz)	$\nu$ $^{13}\text{C}$ (MHz)	$H_o$ (Tesla)
60	15.087	1.4093
90	22.629	2.1139
100	25.144	2.3488
200	50.288	4.6975
400	100.577	9.3950
500	125.720	11.744
600	150.864	14.0923
750	188.580	17.616
800	201.154	18.790
900	226.296	21.128

In common jargon, NMR spectrometers are commonly known by the frequency they use to observe  $^1\text{H}$  *i.e.* as "60 MHz", "200 MHz" or "400 MHz" instruments, even if the spectrometer is set to observe a nucleus other than  $^1\text{H}$ .

All the frequencies listed in Table 5.1 correspond to the radio frequency region of the electromagnetic spectrum and inserting these values into Equation 5.1 gives the size of the energy gap between the states in an NMR experiment. A resonance frequency of 100 MHz corresponds to an energy gap of approximately  $4 \times 10^{-5} \text{ kJmol}^{-1}$ . This is an extremely small value on the chemical energy scale and this means that NMR spectroscopy is, for all practical purposes, a ground-state phenomenon.

Any absorption signal observed in a spectroscopic experiment must originate from excess of the population in the lower energy state, the so called *Boltzmann excess*, which is equal to  $N_\beta - N_\alpha$ , where  $N_\beta$  and  $N_\alpha$  are the populations in the lower ( $\beta$ ) and upper ( $\alpha$ ) energy states.

For molar quantities, the general Boltzmann relation (Equation 5.3) shows that:

$$\frac{N_{\beta}}{N_{\alpha}} = e^{\frac{\Delta E}{RT}} \quad (5.3)$$

Clearly, as the energy gap ( $\Delta E$ ) approaches zero, the right hand side of Equation 5.3 approaches 1 and the Boltzmann excess becomes very small. For the NMR experiment, the population excess in the lower energy state is typically of the order of 1 in  $10^5$  which renders NMR spectroscopy an **inherently insensitive** spectroscopic technique. Equations 5.1 and 5.2 show that the energy gap (and therefore ultimately the Boltzmann excess and sensitivity), increases with increasing applied magnetic field. This is one of the reasons why it is desirable to use high magnetic fields in NMR spectrometers.

## (2) Nuclear Relaxation

Even at the highest fields, the NMR experiment would not be practicable if mechanisms did not exist to restore the Boltzmann equilibrium that is perturbed as the result of the absorption of electromagnetic radiation in making an NMR measurement. These mechanisms are known by the general term of **relaxation** and are not confined to NMR spectroscopy. Because of the small magnitude of the Boltzmann excess in the NMR experiment, relaxation is more critical and more important in NMR than in other forms of spectroscopy.

If relaxation is too efficient (*i.e.* it takes a short time for the nuclear spins to relax after being excited in an NMR experiment) the lines observed in the NMR spectrum are very broad. If relaxation is too slow (*i.e.* it takes a long time for the nuclear spins to relax after being excited in an NMR experiment) the spins in the sample quickly *saturate* and only a very weak signal can be observed.

The most important relaxation processes in NMR involve interactions with other nuclear spins that are in the state of random thermal motion. This is called *spin-lattice relaxation* and results in a simple exponential recovery process after the spins are disturbed in an NMR experiment. The exponential recovery is characterised by a time constant  $T_1$  that can be measured for different types of nuclei. For organic liquids and samples in solution,  $T_1$  is typically of the order of several seconds. In the presence of paramagnetic impurities or in very viscous solvents, relaxation of the spins can be very efficient and NMR spectra obtained become broad.

Nuclei in solid samples typically relax very efficiently and give rise to very broad spectra. NMR spectra of solid samples can only be acquired using specialised spectroscopic equipment and solid state NMR spectroscopy will not be discussed further.

### (3) *The Acquisition of an NMR spectrum*

As the NMR phenomenon is not observable in the absence of an applied magnetic field, a magnet is an essential component of any NMR spectrometer. Magnets for NMR may be permanent magnets (as in many low field routine instruments), electromagnets, or in most modern instruments they are based on superconducting solenoids, cooled by liquid helium. All magnets used for NMR spectroscopy share the following characteristics:

- (a) The magnetic field must be **strong**. This is partly due to the fact that the sensitivity of the NMR experiment increases as the strength of the magnet increases, but more importantly it ensures adequate **dispersion** of signals and, in the case of  $^1\text{H}$  NMR, also very important **simplification** of the spectrum.
- (b) The magnetic field must be extremely **homogeneous** so that all portions of the sample experience exactly the same magnetic field. Any inhomogeneity of the magnetic field will result in broadening and distortion of spectral bands. For determining of the structure of organic compounds, the highest attainable degree of magnetic field homogeneity is desirable, because useful information may be lost if the width of the NMR spectral lines exceeds about 0.2 Hz. Clearly, 0.2 Hz in, say, 100 MHz implies a homogeneity of about 2 parts in  $10^9$ , and this is a very stringent requirement over the whole volume of an NMR sample.
- (c) The magnetic field must be very **stable**, so that it does not drift during the acquisition of the spectrum, which may take from several seconds to several hours.

## 5.2 CONTINUOUS WAVE (CW) NMR SPECTROSCOPY

Inspection of the Larmor equation (Equation 5.2) shows that for any nucleus the condition of resonance may be achieved by keeping the field constant and changing (or sweeping) the frequency or, alternatively, by keeping the frequency constant and sweeping the field. A schematic diagram of a frequency sweep CW NMR spectrometer is given in Figure 5.2.

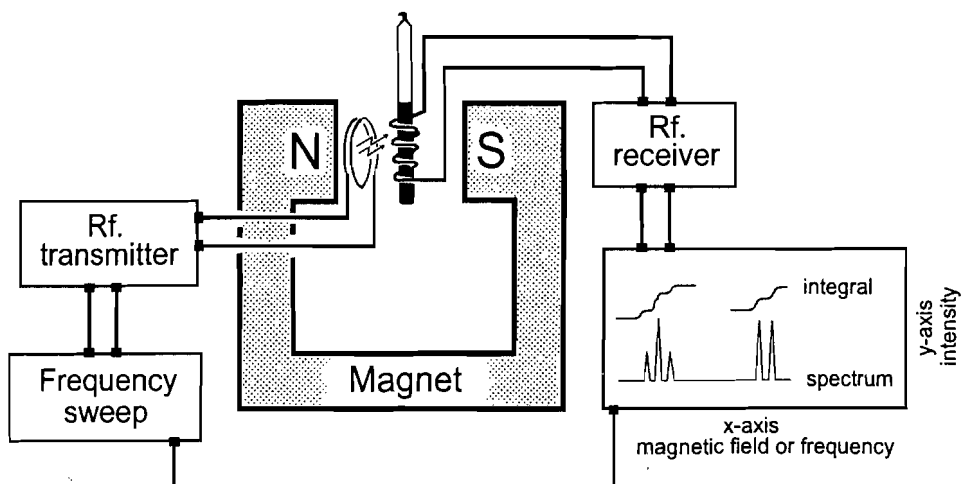

**Figure 5.2 Schematic Representation of a CW NMR Spectrometer**

An NMR spectrum is effectively a graph of the intensity of absorption of Rf radiation (y-axis) against the frequency of the Rf radiation (x-axis). Since frequency and magnetic field strength are linked by the Larmor equation, the x-axis could also be calibrated in units of magnetic field strength. In a CW NMR spectrometer, the x-axis of the output device (usually a pen plotter) is coupled to the frequency sweep so that the response of the sample is displayed as the frequency of the Rf transmitter varies.

NMR spectroscopy is a quantitative technique and  $^1\text{H}$  NMR spectra are usually recorded with an integral which indicates the relative areas of the absorption peaks in the spectrum. The area of a peak is proportional to the number of protons which give rise to the signal. In most NMR spectrometers, the integral is represented as a horizontal line plotted over the spectrum. Whenever a peak is encountered, the vertical displacement of the integral line is proportional to the area of the peak.  $^1\text{H}$  NMR spectroscopy is an excellent tool for the analysis of mixtures – if a sample contains more than one compound then the areas of the signals belonging to each species in the NMR spectrum will reflect the relative concentrations of the species in the mixture.



### 5.3 FOURIER-TRANSFORM (FT) NMR SPECTROSCOPY

As an alternative to the CW method, an intense short pulse of electromagnetic energy can be used to excite the nuclei in an NMR sample. The first property of pulsed NMR spectroscopy is that all of the nuclei are excited simultaneously whereas the CW NMR experiment requires a significant period of time (usually several minutes) to sweep or scan through a range of frequencies. Following the radiofrequency pulse, the magnetism in the sample is sampled as a function of time and, for a single resonance, the detected signal decays exponentially. The detected signal is called a *free induction decay* or FID (Figure 5.3a) and this type of spectrum (known as a *time-domain* spectrum) is converted into the more usual *frequency-domain* spectrum (Figure 5.3b) by performing a mathematical operation known as *Fourier transformation (FT)*. Because the signal needs mathematical processing, pulsed NMR spectrometers require a computer and as well as performing the Fourier transformation, the computer also provides a convenient means of storing NMR data and performing secondary data processing and analysis.

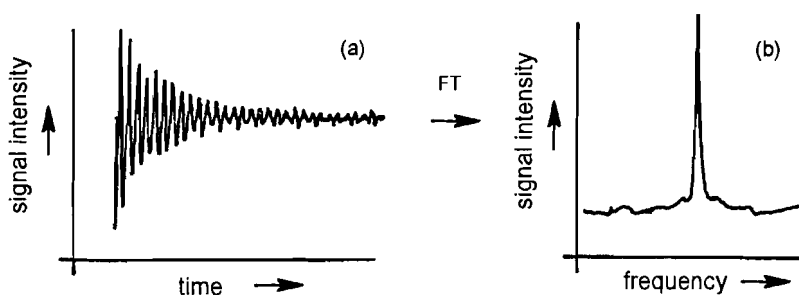

**Figure 5.3** Time Domain and Frequency Domain NMR Spectra

Most NMR spectra consist of a number of signals and their time-domain spectra appear as a superposition of a number of traces of the type shown in Figure 5.3. Such spectra are quite uninterpretable by inspection, but Fourier transformation converts them into ordinary frequency-domain spectra. The time-scale of the FID experiment is of the order of seconds during which the magnetisation may be sampled many thousands of times. Data sampling is accomplished by a dedicated computer that is also used to perform the Fourier transformation.

The principal advantage of FT NMR spectroscopy is a great *increase in sensitivity per unit time* of the experiment. A CW scan generally takes of the order of one hundred

times as long as the collection of the equivalent FID. During the time it would have taken to acquire one CW spectrum, the mini computer can accumulate many FID scans and add them up in its memory. The sensitivity (signal-to-noise ratio) of the NMR spectrum is proportional to the square root of the number of scans which are added together, so the quality of NMR spectra is vastly improved as more scans are added. It is the increase in sensitivity brought about by the introduction of FT NMR spectroscopy that has permitted the routine observation of  $^{13}\text{C}$  NMR spectra.

Although it is possible to acquire many spectra in rapid succession using pulsed NMR methods, one needs to be aware that the speed with which multiple FIDs can be acquired is still subject to the fact that the nuclei in the sample need to relax between acquisitions (Section 5.1). If successive FIDs are acquired too rapidly, intensity information will be distorted because those nuclei which relax slowly will not be fully relaxed when subsequent scans are acquired and they will contribute less to the resulting signal. To ensure that the signal intensities are accurate, the repetition rate needs to be such that even any slowly relaxing nuclei in the sample are fully relaxed between scans.

In addition, the FID can be manipulated mathematically to enhance sensitivity (e.g. for routine  $^{13}\text{C}$  NMR) at the expense of resolution, or to enhance resolution (often important for  $^1\text{H}$  NMR) at the expense of sensitivity. Furthermore, it is possible to devise **sequences** of Rf pulses that result, after suitable mathematical manipulation, in NMR spectroscopic data that are of great value. Such methods (e.g. two-dimensional NMR, mathematical enhancement and massage of data) are, in the most part, beyond the scope of this book however some aspects are discussed in Chapter 7.

## 5.4 CHEMICAL SHIFT IN $^1\text{H}$ NMR SPECTROSCOPY

It is clear that NMR spectroscopy could be used to detect certain nuclei (e.g.  $^1\text{H}$ ,  $^{13}\text{C}$ ,  $^{19}\text{F}$ ,  $^{31}\text{P}$ ) and, also to estimate them quantitatively. The real usefulness of NMR spectroscopy in chemistry is based on secondary phenomena, the *chemical shift* and *spin-spin coupling* and, to a lesser extent, on effects related to the *time-scale* of the NMR experiment. Both the chemical shift and spin-spin coupling reflect the **chemical environment** of the nuclear spins whose spin-flips are observed in the NMR experiment and these can be considered as chemical effects in NMR spectroscopy.

A  $^1\text{H}$  NMR spectrum is a graph of resonance frequency (chemical shift) vs. the intensity of Rf absorption by the sample. The spectrum is usually calibrated in dimensionless units called "parts per million" (abbreviated to ppm) although the horizontal scale is a frequency scale, the units are converted to ppm so that the scale has the same numbers **irrespective of the strength of the magnetic field** in which the measurement was made. The scale in ppm, termed the  $\delta$  scale, is usually referenced to the resonance of some standard substance whose frequency is chosen as 0.0 ppm. The frequency difference between the resonance of a nucleus and the resonance of the reference compound is termed the **chemical shift**.

Tetramethylsilane,  $(\text{CH}_3)_4\text{Si}$ , (abbreviated commonly as TMS) is the usual reference compound chosen for both  $^1\text{H}$  and  $^{13}\text{C}$  NMR and it is normally added directly to the solution of the substance to be examined. TMS has the following advantages as a reference compound:

- it is a relatively inert low boiling (b.p.  $26.5^\circ\text{C}$ ) liquid which can be easily removed after use;
- it gives a sharp single signal in both  $^1\text{H}$  and  $^{13}\text{C}$  because the compound has only one type of hydrogen and one type of carbon;
- the chemical environment of both carbon and hydrogen in TMS is unusual due to the presence of silicon and hence the TMS signal occurs outside the normal range observed for organic compounds so the reference signal is unlikely to overlap a signal from the substance examined;
- the chemical shift of TMS is not substantially affected by complexation or solvent effects because the molecule doesn't contain any polar groups.

Chemical shifts can be measured in Hz but are more usually expressed in ppm.

$$\text{chemical shift } (\delta) \text{ in ppm} = \frac{\text{chemical shift from TMS in Hz}}{\text{spectrometer frequency in MHz}}$$

Note that for a spectrometer operating at 200 MHz, 1 ppm corresponds to 200 Hz *i.e.* for a spectrometer operating at  $x$  MHz, 1.00 ppm corresponds to exactly  $x$  Hz.

For the majority of organic compounds, the chemical shift range for  $^1\text{H}$  covers approximately the range 0-10 ppm (from TMS) and for  $^{13}\text{C}$  covers approximately the range 0-220 ppm (from TMS). By convention, the  $\delta$  scale runs (with increasing values) from right-to-left; for  $^1\text{H}$ .

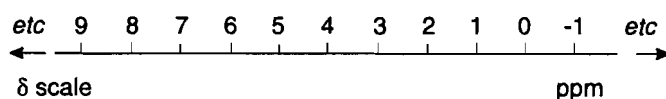

Each  $^1\text{H}$  nucleus is **shielded or screened** by the electrons that surround it. Consequently each nucleus feels the influence of the main magnetic field to a different extent, depending on the efficiency with which it is screened. Each  $^1\text{H}$  nucleus with a different chemical environment has a slightly different shielding and hence a different chemical shift in the  $^1\text{H}$  NMR spectrum. Conversely, the number of different signals in the  $^1\text{H}$  NMR spectrum reflects the number of chemically distinct environments for  $^1\text{H}$  in the molecule. Unless two  $^1\text{H}$  environments are precisely identical (by symmetry) *their chemical shifts must be different*. When two nuclei have identical molecular environments and hence the same chemical shift, they are termed *chemically equivalent* or *isochronous* nuclei. Non-equivalent nuclei that fortuitously have chemical shifts that are so close that their signals are indistinguishable are termed *accidentally equivalent* nuclei.

The chemical shift of a nucleus reflects the molecular structure and it can therefore be used to obtain structural information. Further, as hydrogen and carbon (and therefore  $^1\text{H}$  and  $^{13}\text{C}$  nuclei) are universal constituents of organic compounds the amount of structural information available from  $^1\text{H}$  and  $^{13}\text{C}$  NMR spectroscopy greatly exceeds in value the information available from other forms of molecular spectroscopy.

**Every hydrogen and carbon atom in an organic molecule is "a chromophore" for NMR spectroscopy.**

For  $^1\text{H}$  NMR, the intensity of the signal (which may be measured by electronically measuring the area under individual resonance signals) is directly proportional to the number of nuclei undergoing a spin-flip and **proton NMR spectroscopy is a quantitative method.**

Any effect which alters the density or spatial distribution of electrons around a  $^1\text{H}$  nucleus will alter the degree of shielding and hence its chemical shift.  $^1\text{H}$  chemical shifts are sensitive to both the hybridisation of the atom to which the  $^1\text{H}$  nucleus is attached ( $sp^2$ ,  $sp^3$  etc.) and to electronic effects (the presence of neighbouring electronegative/electropositive groups).

Nuclei tend to be deshielded by groups which withdraw electron density. Deshielded nuclei resonate at higher  $\delta$  values (away from TMS). Conversely shielded nuclei resonate at lower  $\delta$  values (towards TMS).

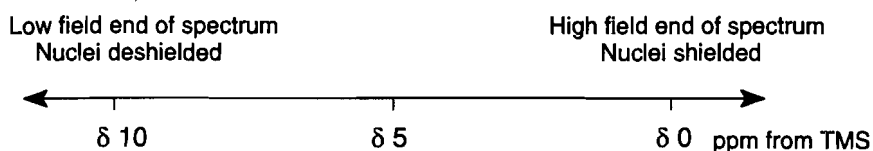

*Electron withdrawing substituents* (-OH, -OCOR, -OR, -NO<sub>2</sub>, halogen) attached to an aliphatic carbon chain cause a **downfield shift** of 2-4 ppm when present at C<sub>α</sub> and have less than half of this effect when present at C<sub>β</sub>.

When *sp*<sup>2</sup> hybridised carbon atoms (carbonyl groups, olefinic fragments, aromatic rings) are present in an aliphatic carbon chain they cause a downfield shift of 1-2 ppm when present at C<sub>α</sub>. They have less than half of this effect when present at C<sub>β</sub>.

Tables 5.2 and 5.3 give characteristic shifts for <sup>1</sup>H nuclei in some representative organic compounds. Table 5.4 gives characteristic chemical shifts for protons in common alkyl derivatives. Table 5.5 gives characteristic chemical shifts for the olefinic protons in common substituted alkenes. To a first approximation, the shifts induced by substituents attached an alkene are additive. So, for example, an olefinic proton which is *trans* to a -CN group and has a geminal alkyl group will have a chemical shift of approximately 6.25 ppm [ $5.25 + 0.55(\textit{trans}\text{-CN}) + 0.45(\textit{gem}\text{-alkyl})$ ].

**Table 5.2** Typical <sup>1</sup>H Chemical Shift Values in Selected Organic Compounds

Compound	δ <sup>1</sup> H (ppm from TMS)
CH <sub>4</sub>	0.23
CH <sub>3</sub> Cl	3.05
CH <sub>2</sub> Cl <sub>2</sub>	5.33
CHCl <sub>3</sub>	7.27
CH <sub>3</sub> CH <sub>3</sub>	0.86
CH <sub>2</sub> =CH <sub>2</sub>	5.25
benzene	7.26
CH <sub>3</sub> CHO	2.20 (CH <sub>3</sub> ), 9.80 (-CHO)
CH <sub>3</sub> CH <sub>2</sub> CH <sub>2</sub> Cl	1.06 (CH <sub>3</sub> ), 1.81(-CH <sub>2</sub> -), 3.47(-CH <sub>2</sub> -Cl)

Table 5.3 Typical  $^1\text{H}$  Chemical Shift Ranges in Organic Compounds

Group*	$\delta$ $^1\text{H}$ (ppm from TMS)
Tetramethylsilane $(\text{CH}_3)_4\text{Si}$	0
Methyl groups attached to $sp^3$ hybridised carbon atoms	0.8 - 1.2
Methylene groups attached to $sp^3$ hybridised carbon atoms	1.0 - 1.5
Methine groups attached to $sp^3$ hybridised carbon atoms	1.2 - 1.8
Acetylenic protons	2 - 3.5
Olefinic protons	5 - 8
Aromatic and heterocyclic protons	6 - 9
Aldehydic protons	9 - 10

\*  $-\text{OH}$  protons in alcohols, phenols or carboxylic acids;  $-\text{SH}$  protons in thiols;  $-\text{NH}$  protons in amines or amides do not have reliable chemical shift ranges (see page 49).

Table 5.4  $^1\text{H}$  Chemical Shifts ( $\delta$ ) for Protons in Common Alkyl Derivatives

X	$\text{CH}_3-\text{X}$	$\text{CH}_3\text{CH}_2-\text{X}$		$(\text{CH}_3)_2\text{CH}-\text{X}$	
	$-\text{CH}_3$	$-\text{CH}_3$	$-\text{CH}_2-$	$-\text{CH}_3$	$\text{>CH}-$
$-\text{H}$	0.23	0.86	0.86	0.91	1.33
$-\text{CH}=\text{CH}_2$	1.71	1.00	2.00	1.00	1.73
$-\text{Ph}$	2.35	1.21	2.63	1.25	2.89
$-\text{Cl}$	3.06	1.33	3.47	1.55	4.14
$-\text{Br}$	2.69	1.66	3.37	1.73	4.21
$-\text{I}$	2.16	1.88	3.16	1.89	4.24
$-\text{OH}$	3.39	1.18	3.59	1.16	3.94
$-\text{OCH}_3$	3.24	1.15	3.37	1.08	3.55
$-\text{O}-\text{Ph}$	3.73	1.38	3.98	1.31	4.51
$-\text{OCO}-\text{CH}_3$	3.67	1.21	4.05	1.22	4.94
$-\text{OCO}-\text{Ph}$	3.89	1.38	4.37	1.36	5.30
$-\text{CO}-\text{CH}_3$	2.09	1.05	2.47	1.08	2.54
$-\text{CO}-\text{Ph}$	2.55	1.18	2.92	1.22	3.58
$-\text{CO}-\text{OCH}_3$	2.01	1.12	2.28	1.15	2.48
$-\text{NH}_2$	2.47	1.10	2.74	1.03	3.07
$-\text{NH}-\text{COCH}_3$	2.71	1.12	3.21	1.13	4.01
$-\text{C}\equiv\text{N}$	1.98	1.31	2.35	1.35	2.67
$-\text{NO}_2$	4.29	1.58	4.37	1.53	4.44

**Table 5.5** Approximate  $^1\text{H}$  Chemical Shifts ( $\delta$ ) for Olefinic Protons  
 $\text{C}=\text{C}-\text{H}$



X	$\sigma_{\text{gem}}$	$\sigma_{\text{cis}}$	$\sigma_{\text{trans}}$
—H	0.0	0.0	0.0
—alkyl	0.45	-0.22	-0.28
—aryl	1.38	0.36	-0.07
—CH=CH <sub>2</sub>	1.00	-0.09	-0.23
—CH=CH—conjugated	1.24	0.02	-0.05
—C≡C—H	0.47	0.38	0.12
—CO—R	1.10	1.12	0.87
—CO—OH	0.80	0.98	0.32
—CO—OR	0.78	1.01	0.46
—C≡N	0.27	0.75	0.55
—Cl	1.08	0.18	0.13
—Br	1.07	0.45	0.55
—OR	1.22	-1.07	-1.21
—NR <sub>2</sub>	0.80	-1.26	-1.21

Table 5.6 gives characteristic  $^1\text{H}$  chemical shifts for the aromatic protons in benzene derivatives. To a first approximation, the shifts induced by substituents are additive. So, for example, an aromatic proton which has a  $-\text{NO}_2$  group in the *para* position and a  $-\text{Br}$  group in the *ortho* position will appear at approximately 7.82 ppm  $[(7.26 + 0.38(p-\text{NO}_2) + 0.18(o-\text{Br}))]$ .

Tables 5.7 gives characteristic chemical shifts for  $^1\text{H}$  nuclei in some polynuclear aromatic compounds and heteroaromatic compounds.

**Table 5.6**  $^1\text{H}$  Chemical Shifts ( $\delta$ ) for Aromatic Protons in Benzene Derivatives Ph-X in ppm Relative to Benzene at  $\delta$  7.26 ppm (positive sign denotes a downfield shift)

X	<i>ortho</i>	<i>meta</i>	<i>para</i>
—H	0.0	0.0	0.0
—CH <sub>3</sub>	-0.20	-0.12	-0.22
—C(CH <sub>3</sub> ) <sub>3</sub>	-0.03	-0.08	0.20
—CH=CH <sub>2</sub>	0.06	-0.03	-0.10
—C $\equiv$ C—H	0.16	-0.04	-0.02
—CO—OR	0.71	0.11	0.21
—CO—R	0.62	0.14	0.21
—OCO—R	-0.25	0.03	-0.13
—OCH <sub>3</sub>	-0.48	-0.09	-0.44
—OH	-0.56	-0.12	-0.45
—Cl	0.03	-0.02	-0.09
—Br	0.18	-0.08	-0.04
—C $\equiv$ N	0.36	0.18	0.28
—NO <sub>2</sub>	0.95	0.26	0.38
—NR <sub>2</sub>	-0.66	-0.18	-0.67
—NH <sub>2</sub>	-0.75	-0.25	-0.65

**Table 5.7**  $^1\text{H}$  Chemical Shifts ( $\delta$ ) in some Polynuclear Aromatic Compounds and Heteroaromatic Compounds

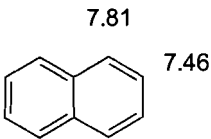
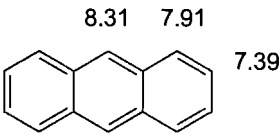
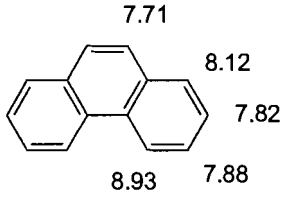
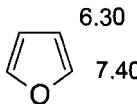
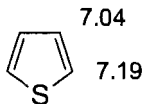
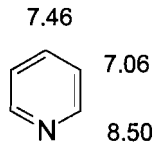

The chemical shift of a nucleus may also be affected by the presence in its vicinity of a *magnetically anisotropic* group (e.g. an aromatic ring or carbonyl group). In an aromatic ring, the "circulation" of electrons effectively forms a current loop which gives rise to an induced magnetic field. This is called the **ring current effect** and the induced field opposes the applied magnetic field of the spectrometer ( $B_0$ ) inside the loop and enhances the field outside the loop. The resonance of a nucleus which is located close to the face of an aromatic ring will be shifted to high field (towards TMS) because it experiences the effect of both the main spectrometer magnetic field but also the magnetic field from the ring current effect of the aromatic ring. Conversely a proton which is in the plane of an aromatic ring is deshielded by the ring current effect.

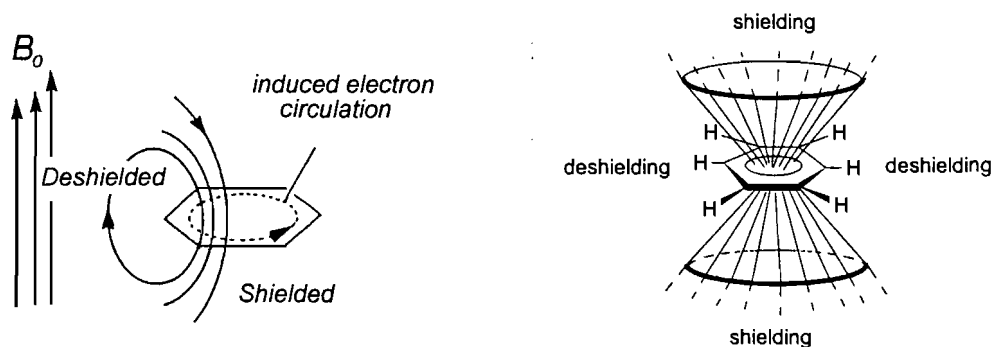

The ring current effect is the main reason that protons attached to aromatic rings typically appear at the low field end of the  $^1\text{H}$  NMR spectrum since they are in the deshielded zone of the aromatic ring.

There are also a number of common non-aromatic organic functional groups which are magnetically anisotropic and influence the magnetic field experienced by nearby nuclei. The greatest influence comes from multiple bonds and in particular, the  $\text{C}=\text{C}$  group, the  $\text{C}\equiv\text{N}$  group, and  $\text{C}=\text{C}$ ,  $\text{N}=\text{O}$  and  $\text{C}=\text{O}$  groups have strong magnetic anisotropies. Figure 5.4 depicts the shielding and de-shielding zones around common non-aromatic functional groups

Shielding effects diminish with distance but are useful qualitative indicators of what groups are close by and also their geometric relationship in the three-dimensional structure of the molecule.

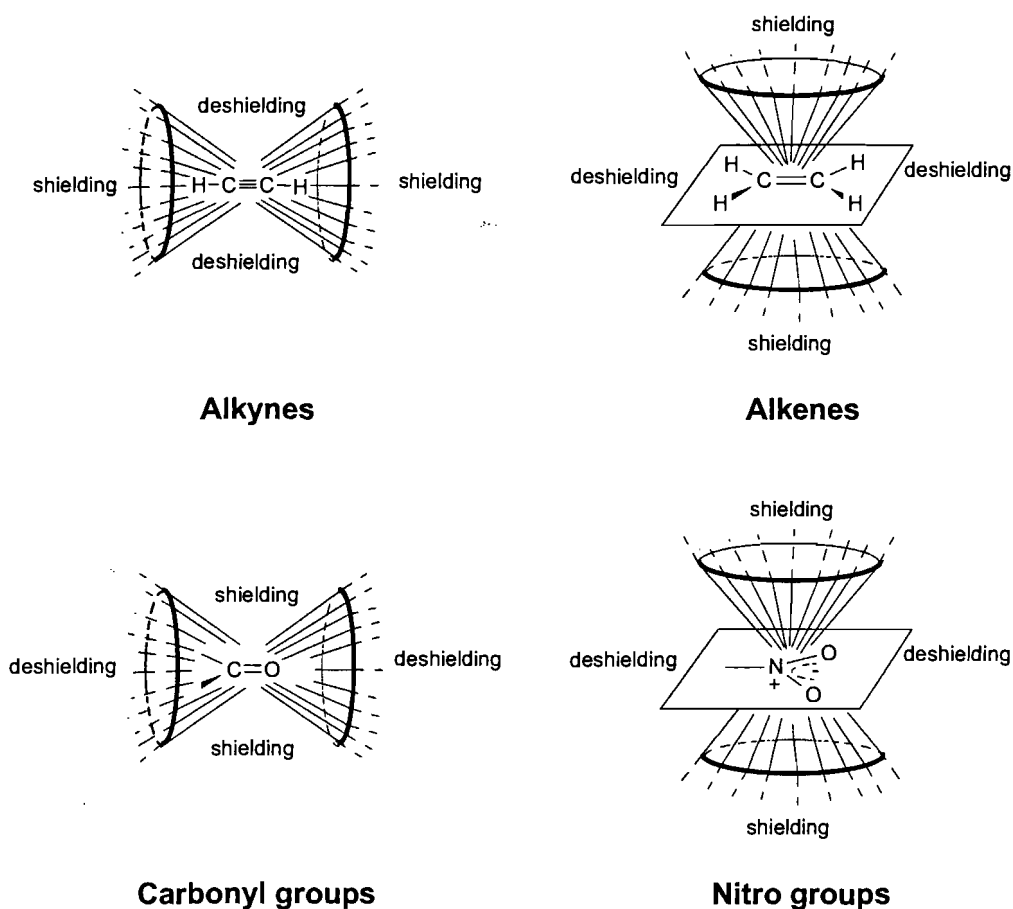

**Figure 5.4 Shielding/deshielding Zones for Common Non-aromatic Functional Groups**

**Solvents for NMR Spectroscopy.** NMR spectra are almost invariably obtained in solution. The solvents of choice:

- should have adequate dissolving power.
- should not associate strongly with solute molecules as this is likely to produce appreciable effects on chemical shifts. This requirement must sometimes be sacrificed to achieve adequate solubility.
- should be essentially free of interfering signals. Thus for  $^1\text{H}$  NMR, the best solvents are proton-free.
- should preferably contain deuterium,  $^2\text{H}$ . Deuterium is an isotope of hydrogen which is relatively easy to obtain and incorporate into common solvents in place of hydrogen with insignificant changes to the properties of the solvent. Almost all NMR instruments use deuterium as a convenient "locking" signal for to stabilise the magnetic field of the NMR magnet.

The most commonly used organic solvent is **deuteriochloroform**,  $\text{CDCl}_3$ , which is an excellent solvent and is only weakly associated with most organic substrates.  $\text{CDCl}_3$  contains no protons and has a deuterium atom. For ionic compounds or hydrophilic compounds, the most common solvent is deuterated water,  $\text{D}_2\text{O}$ .

Almost all deuterated solvents are not 100% deuterated and they contain a residual protonated impurity. With the sensitivity of modern NMR instruments, the signal from residual protons in the deuterated solvent is usually visible in the  $^1\text{H}$  NMR spectrum. For many spectra, the signal from residual protons can be used as a reference signal (instead of adding TMS) since the chemical shifts of most common solvents are known accurately. In  $\text{CDCl}_3$ , the residual  $\text{CHCl}_3$  has a shift of 7.27 ppm in the  $^1\text{H}$  NMR spectrum. Solvents that are miscible with water (and are difficult to “dry” completely) *e.g.*  $\text{CD}_3\text{COCD}_3$ ,  $\text{CD}_3\text{SOCD}_3$ ,  $\text{D}_2\text{O}$ , also commonly contain a small amount of residual water. The residual water typically appears as a broad resonance in the region 3 – 5 ppm in the  $^1\text{H}$  NMR spectrum.

**Labile and Exchangeable protons.** Protons in groups such as alcohols (R-OH) amines (R-NH-), carboxylic acids (RCOOH), thiols (R-SH) and to a lesser extent amides (R-CO-NH-) are classified as labile or readily exchangeable protons.

Labile protons frequently give rise to broadened resonances in the  $^1\text{H}$  NMR spectrum and their chemical shifts are critically dependent on the solvent, concentration, and on temperature and *they do not have reliable characteristic chemical shift ranges*.

Labile protons exchange rapidly with each other and also with protons in water or with the deuterons in  $\text{D}_2\text{O}$ .

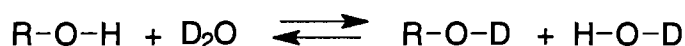

Labile protons can always be positively identified by *in situ* exchange with  $\text{D}_2\text{O}$ . In practice, a normal  $^1\text{H}$  NMR spectrum is recorded then deuterium exchange of labile protons is achieved by simply adding a drop of deuterated water ( $\text{D}_2\text{O}$ ) to the NMR sample. Labile protons in -OH, -COOH, -NH<sub>2</sub> and -SH groups exchange rapidly for deuterons in  $\text{D}_2\text{O}$  and the  $^1\text{H}$  NMR is recorded again. Since deuterium is invisible in the  $^1\text{H}$  NMR spectrum, labile protons disappear from the  $^1\text{H}$  NMR spectrum and can be readily identified by comparison of the spectra before and after  $\text{D}_2\text{O}$  is addition.

The N-H protons of primary and secondary amides are slow to exchange and require heating or base catalysis and this is one way an amide functional group can be distinguished from other functional groups.

## 5.5 SPIN-SPIN COUPLING IN $^1\text{H}$ NMR SPECTROSCOPY

A typical organic molecule contains more than one magnetic nucleus (*e.g.* more than one  $^1\text{H}$ , or  $^1\text{H}$  and  $^{31}\text{P}$  *etc.*). When one nucleus can sense the presence of other nuclei **through the bonds of the molecule** the signals will exhibit fine structure (*splitting or multiplicity*). Multiplicity arises because if an observed nucleus can sense the presence of other nuclei with magnetic moments, those nuclei could be in either the  $\alpha$  or  $\beta$  state. The observed nucleus is either slightly stabilised or slightly destabilised by depending on which state the remote nuclei are in, and as a consequence nuclei which sense coupled partners with an  $\alpha$  state have a slightly different energy to those which sense coupled partners with a  $\beta$  state.

The additional fine structure caused by spin-spin coupling is not only the principal cause of difficulty in interpreting  $^1\text{H}$  NMR spectra, but also provides valuable structural information when correctly interpreted. The **coupling constant** (related to the size of the splittings in the multiplet) is given the symbol  $J$  and is measured in Hz. By convention, a superscript before the symbol ' $J$ ' represents the number of intervening bonds between the coupled nuclei. Labels identifying the coupled nuclei are usually indicated as subscripts after the symbol ' $J$ ' *e.g.*  $^2J_{ab} = 2.7$  Hz would indicate a coupling of 2.7 Hz between nuclei  $a$  and  $b$  which are separated by two intervening bonds.

Because  $J$  depends only on the number, type and spatial arrangement of the bonds separating the two nuclei, it is a property of the molecule and is **independent of the applied magnetic field**. The magnitude of  $J$ , or even the mere presence of detectable interaction, constitutes valuable structural information.

Two important observations that relate to  $^1\text{H}$  -  $^1\text{H}$  spin-spin coupling:

- (a) No **inter-molecular** spin-spin coupling is observed. Spin-spin coupling is transmitted through the bonds of a molecule and doesn't occur between nuclei in different molecules.
- (b) The effect of coupling falls off as the number of bonds between the coupled nuclei increases.  $^1\text{H}$  -  $^1\text{H}$  coupling is generally unobservable across more than 3 intervening bonds. Unexpectedly large couplings across many bonds may occur if there is a particularly favourable bonding pathway *e.g.* extended  $\pi$ -conjugation or a particularly favourable rigid  $\sigma$ -bonding skeleton (Table 5.8).

**Table 5.8** Typical  $^1\text{H} - ^1\text{H}$  Coupling Constants

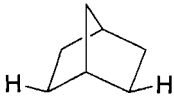
Group	$J(\text{Hz})$
$\text{CH}_3\text{CH}_2\text{CH}_2\text{CH}_3$	$^2J_{\text{HH}} \approx -16$
$\text{CH}_3\text{CH}_2\text{CH}_2\text{CH}_3$	$^3J_{\text{HH}} = 7.2$
$\text{CH}_3\text{CH}_2\text{CH}_2\text{CH}_3$	$^4J_{\text{HH}} = 0.3$
$\text{H}_2\text{C}=\text{C}=\text{C}=\text{CH}_2$	$^5J_{\text{HH}} = 7$
$\text{H}_2\text{C}=\text{CH}-\text{CH}=\text{CH}_2$	$^5J_{\text{HH}} = 1.3$
	$^4J_{\text{HH}} = 1.5$

**Signal Multiplicity - the  $n+1$  rule.** Spin-spin coupling gives rise to multiplet splittings in  $^1\text{H}$  NMR spectra. The NMR signal of a nucleus coupled to  $n$  equivalent hydrogens will be split into a multiplet with  $(n+1)$  lines. For simple multiplets, the spacing between the lines (in Hz) is the coupling constant. The relative intensity of the lines in multiplet will be given by the binomial coefficients of order ' $n$ ' (Table 5.9).

**Table 5.9** Relative Line Intensities for Simple Multiplets

$n$	multiplicity $n+1$	relative line intensities	multiplet name
0	1	1	singlet
1	2	1 : 1	doublet
2	3	1 : 2 : 1	triplet
3	4	1 : 3 : 3 : 1	quartet
4	5	1 : 4 : 6 : 4 : 1	quintet
5	6	1 : 5 : 10 : 10 : 5 : 1	sextet
6	7	1 : 6 : 15 : 20 : 15 : 6 : 1	septet
7	8	1 : 7 : 21 : 35 : 35 : 21 : 7 : 1	octet
8	9	1 : 8 : 28 : 56 : 70 : 56 : 28 : 8 : 1	nonet

These simple multiplet patterns give rise to characteristic "fingerprints" for common fragments of organic structures. A methyl group,  $-\text{CH}_3$ , (isolated from coupling to other protons in the molecule) will always occur as a singlet. A  $\text{CH}_3-\text{CH}_2-$  group, (isolated from coupling to other protons in the molecule) will appear as a quartet ( $-\text{CH}_2-$ ) and a triplet ( $\text{CH}_3-$ ). Table 5.10 shows the schematic appearance of the NMR spectra of various common molecular fragments encountered in organic molecules.

**Table 5.10 Characteristic Multiplet Patterns for Common Organic Fragments**

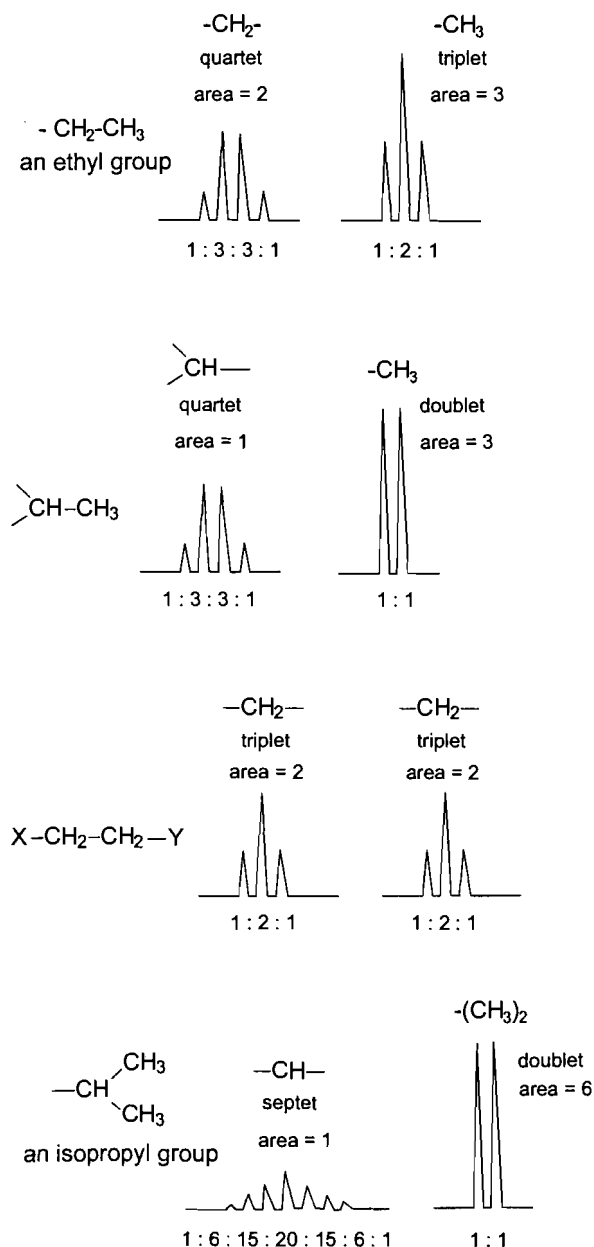

## 5.6 ANALYSIS OF $^1\text{H}$ NMR SPECTRA

To obtain structurally useful information from NMR spectra, one must solve two separate problems. Firstly, one must **analyse** the spectrum to obtain the NMR parameters (chemical shifts and coupling constants) for all the protons and, secondly, one must interpret the values of the coupling constants in terms of established relationships between these parameters and structure.

(1) **A spin system** is defined as a group of coupled protons. Clearly, a spin system cannot extend beyond the bounds of a molecule, but it may not include a whole molecule. For example, isopropyl propionate comprises **two** separate and isolated proton spin systems, a seven-proton system for the isopropyl residue and a five-proton system for the propionate residue, because the ester group effectively provides a barrier (5 bonds) against coupling between the two parts.

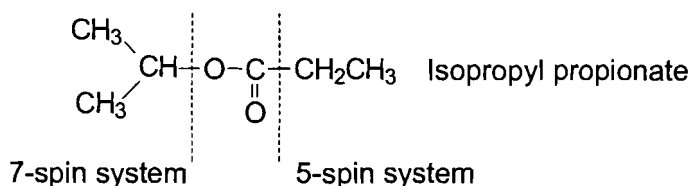

(2) **Strongly and weakly coupled spins.** These terms refer not to the actual magnitude of  $J$ , but to the **ratio** of the separation of chemical shifts expressed in Hz ( $\Delta\nu$ ) to the coupling constant  $J$  between them. For most purposes, if  $\Delta\nu/J$  is larger than  $\sim 3$ , the spin system is termed *weakly coupled*. When this ratio is smaller than  $\sim 3$ , the spins are termed *strongly coupled*. Two important conclusions follow:

(a) Because the chemical shift separation ( $\Delta\nu$ ) is expressed in Hz, rather than in the dimensionless  $\delta$  units, its value will change with the operating frequency of the spectrometer, while the value of  $J$  remains constant. It follows that two spins will become progressively more weakly coupled as the spectrometer frequency increases. **Weakly coupled spin systems are much more easy to analyse than strongly coupled spin systems** and thus spectrometers operating at higher frequencies (and therefore at higher applied magnetic fields) will yield spectra which are more easily interpreted. This has been an important reason for the development of NMR spectrometers operating at ever higher magnetic fields.

(b) Within a spin system, some pairs of nuclei or groups of nuclei may be strongly coupled and others weakly coupled. Thus a spin-system may be *partially strongly coupled*.

(3) **Magnetic equivalence.** A group of protons is *magnetically equivalent* when they not only have the same chemical shift (chemical equivalence) but also have identical spin-spin coupling to each individual nucleus **outside** the group.

(4) **Conventions used in naming spin systems.** Consecutive letters of the alphabet (*e.g.* A, B, C D, ....) are used to describe groups of protons which are strongly coupled. Subscripts are used to give the number of protons that are magnetically equivalent. Primes are used to denote protons that are chemically equivalent but not magnetically equivalent. A break in the alphabet indicates weakly coupled groups. For example:

ABC denotes a strongly coupled 3-spin system

AMX denotes a weakly coupled 3-spin system

ABX denotes a *partially* strongly coupled 3-spin system

A<sub>3</sub>BMXY denotes a spin system in which the three magnetically equivalent A nuclei are strongly coupled to the B nucleus, but weakly coupled to the M, X and Y nuclei. The nucleus X is strongly coupled to the nucleus Y but weakly coupled to all the other nuclei. The nucleus M is weakly coupled to all the other 6 nuclei.

AA'XX' is a 4-spin system described by two chemical shift parameters (for the nuclei A and X) but where  $J_{AX} \neq J_{AX'}$ . A and A' (as well as X and X') are pairs of nuclei which are chemically equivalent but magnetically non-equivalent.

The process of deriving the NMR parameters ( $\delta$  and  $J$ ) from a set of multiplets in a spin system is known as *the analysis of the NMR spectrum*. In principle, **any** spectrum arising from a spin system, however complicated, can be analysed but some will require calculations or simulations performed by a computer.

Fortunately, in a very large number of cases, multiplets can be correctly analysed by inspection and direct measurements. These spectra are known as *first order spectra* and **they arise from weakly coupled spin systems**. At high applied magnetic fields, a large proportion of <sup>1</sup>H NMR spectra are nearly pure first-order and there is a tendency for simple molecules, *e.g.* those exemplified in the problems in this text, to exhibit first-order spectra even at moderate fields.



## 5.7 RULES FOR SPECTRAL ANALYSIS OF FIRST ORDER SPECTRA

- Rule 1** A group of  $n$  magnetically equivalent protons will split a resonance of an interacting group of protons into  $n+1$  lines. For example, the resonance due to the A protons in an  $A_nX_m$  system will be split into  $m+1$  lines, while the resonance due to the X protons will be split into  $n+1$  lines. More generally, splitting by  $n$  nuclei of spin quantum number  $I$ , results in  $2nI+1$  lines. This simply reduces to  $n+1$  for protons where  $I = \frac{1}{2}$ .
- Rule 2** The spacing (measured in Hz) of the lines in the multiplet will be equal to the coupling constant. In the above example all spacings in both parts of the spectrum will be equal to  $J_{AX}$ .
- Rule 3** The true chemical shift of each group of interacting protons lies in the centre of the (always symmetrical) multiplet.
- Rule 4** The relative intensities of the lines within each multiplet will be in the ratio of the binomial coefficients (Table 5.9). Note that, in the case of higher multiplets, the outside components of multiplets are relatively weak and may be lost in the instrumental noise, e.g. a septet may appear as a quintet if the outer lines are not clearly visible. The intensity relationship is the first to be significantly distorted in non-ideal cases, but this does not lead to serious errors in spectral analysis.
- Rule 5** When a group of magnetically equivalent protons interacts with more than one group of protons, its resonance will take the form of a *multiplet of multiplets*. For example, the resonance due to the A protons in a system  $A_nM_pX_m$  will have the multiplicity of  $(p+1)(m+1)$ . The multiplet patterns are chained e.g. a proton coupled to 2 different protons will be split to a doublet by coupling to the first proton then each of the component of the doublet will be split further by coupling to the second proton resulting in a symmetrical multiplet with 4 lines (a doublet of doublets).

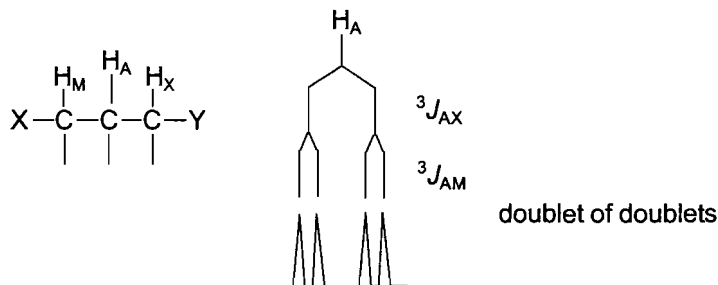

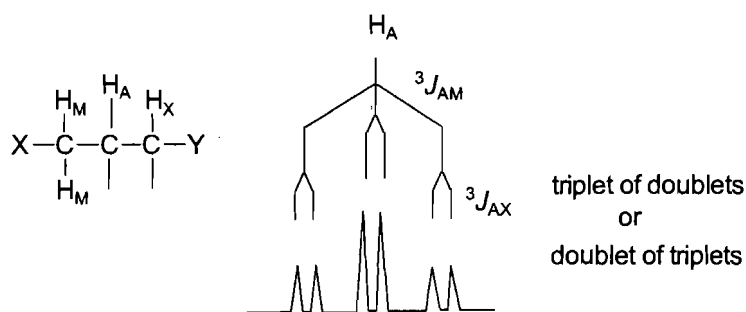

The appropriate coupling constants will control splitting and relative intensities will obey rule 4.

- Rule 6** Protons that are magnetically equivalent do not split each other. Any system  $A_n$  will give rise to a singlet.
- Rule 7** Spin systems that contain groups of chemically equivalent protons that are not magnetically equivalent **cannot be analysed by first-order methods**.
- Rule 8** If  $\Delta\nu_{AB}/J_{AB}$  is less than  $\sim 3$ , for **any** pair of nuclei A and B in the spin system, the spectra become distorted from the expected ideal multiplet patterns and the spectra **cannot be analysed by first-order methods**.

**(1) Splitting Diagrams**

The knowledge of the rules listed above, permits the development of a simple procedure for the analysis of any spectrum which is suspected of being first order. The first step consists of drawing a *splitting diagram*, from which the line spacings can be measured and identical (hence related) splittings can be identified (Figure 5.5).

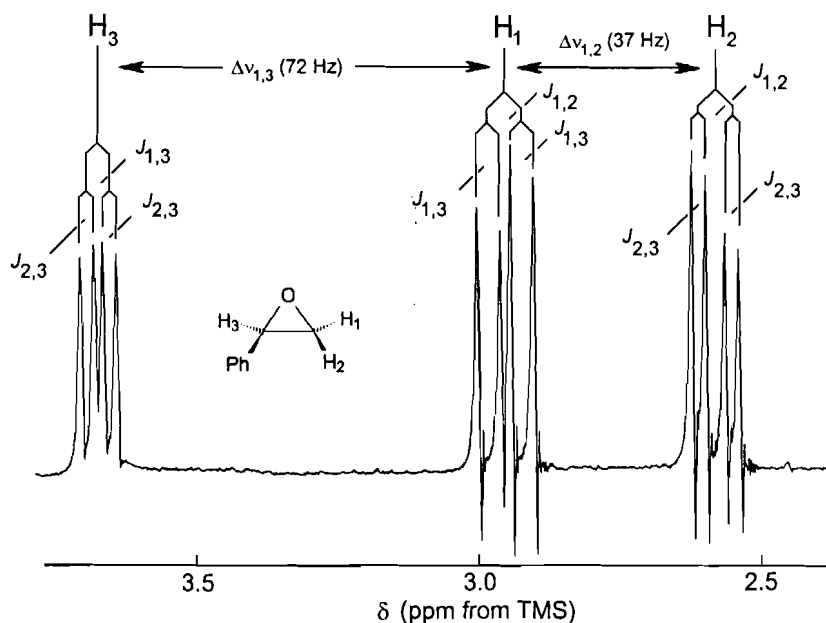

**Figure 5.5** A Portion of the  $^1\text{H}$  NMR Spectrum of Styrene Epoxide (100 MHz as a 5% solution in  $\text{CCl}_4$ )

The section of the spectrum of styrene epoxide (Figure 5.5) clearly contains the signals from 3 separate protons (identified as  $\text{H}_1$ ,  $\text{H}_2$  and  $\text{H}_3$ ) with  $\text{H}_1$  at  $\delta$  2.95,  $\text{H}_2$  at  $\delta$  2.58 and  $\text{H}_3$  at  $\delta$  3.67 ppm. Each signal appears as a doublet of doublets and the chemical shift of each proton is simply obtained by locating the centre of the multiplet. The pair of nuclei giving rise to each splitting is clearly indicated by the splitting diagram above each multiplet with  $^2J_{\text{H}_1\text{-H}_2} = 5.9$  Hz,  $^3J_{\text{H}_1\text{-H}_3} = 4.0$  Hz and  $^3J_{\text{H}_2\text{-H}_3} = 2.5$  Hz.

The validity of a first order analysis can be verified by calculating the ratio  $\Delta\nu/J$  for each pair of nuclei and establishing that it is greater than 3.

From Figure 5.5

$$\frac{\Delta\nu_{12}}{J_{12}} = \frac{37}{5.9} = 6.3 \quad \frac{\Delta\nu_{13}}{J_{13}} = \frac{72}{4.0} = 18.0 \quad \frac{\Delta\nu_{23}}{J_{23}} = \frac{109}{2.5} = 43.6$$

Each ratio is greater than 3 so a first order analysis is justified and the 100 MHz spectrum of the aliphatic protons of styrene oxide is indeed a first order spectrum and could be labelled as an AMX spin system.

The 60 MHz  $^1\text{H}$  spectrum of a 4 spin  $\text{AMX}_2$  system is given in Figure 5.6. This system contains 3 separate proton signals (in the intensity ratios 1:1:2, identified as  $\text{H}_\text{A}$ ,  $\text{H}_\text{M}$  and  $\text{H}_\text{X}$ ). The multiplicity of  $\text{H}_\text{A}$  is a triplet of doublets, the multiplicity of  $\text{H}_\text{M}$  is a triplet of doublets and the multiplicity of  $\text{H}_\text{X}$  is a doublet of doublets. Again, the nuclei giving rise to each splitting are clearly indicated by the splitting diagram above each multiplet and the chemical shifts of each multiplet are simply obtained by measuring the centres of each multiplet.

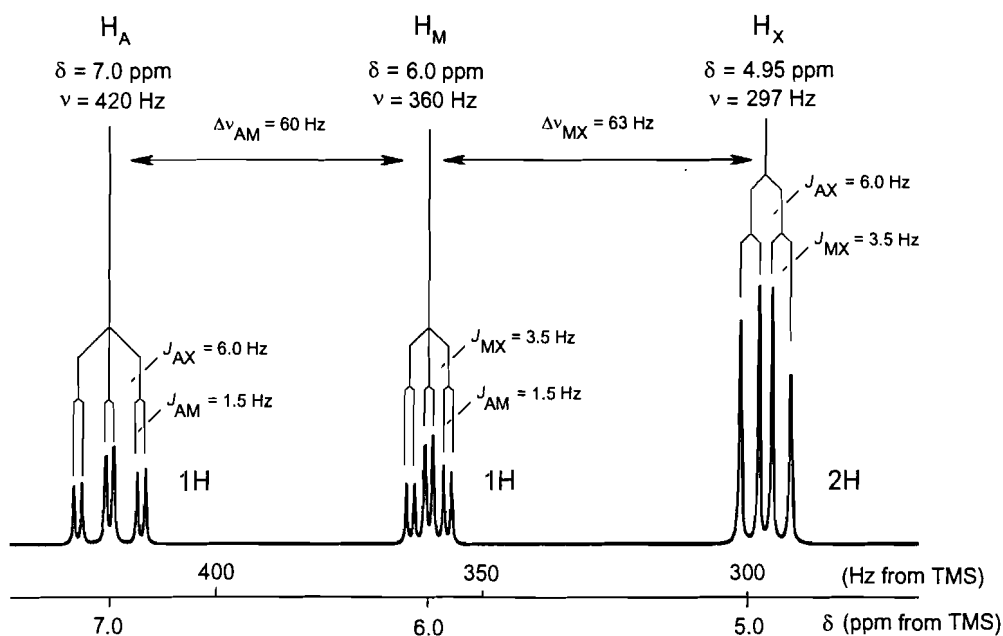
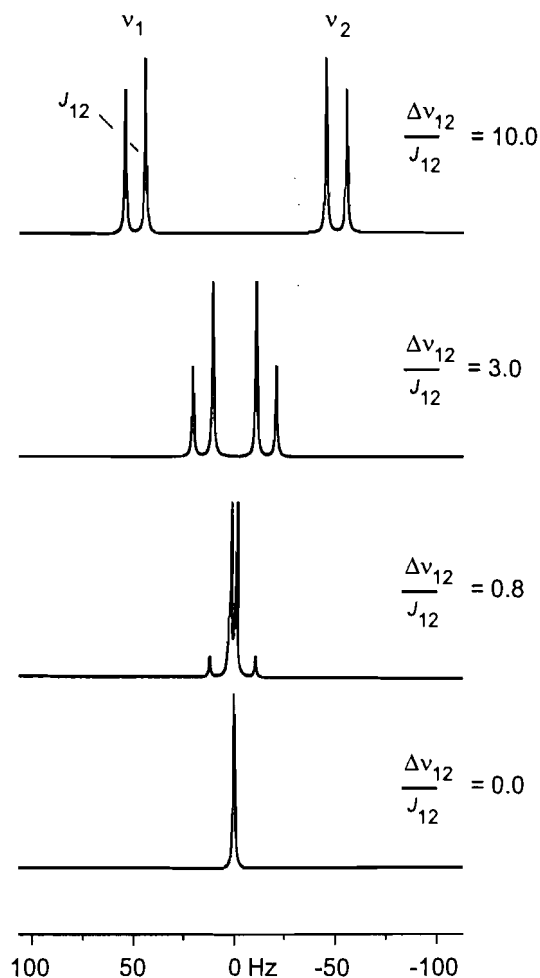

Figure 5.6 The 60 MHz  $^1\text{H}$  NMR Spectrum of a 4-Spin  $\text{AMX}_2$  Spin System

A spin system comprising just two protons (*i.e.* an AX or an AB system) is always exceptionally easy to analyse because, independent of the value of the ratio of  $\Delta\nu/J$ , the spectrum always consists of just four lines with each pair of lines separated by the coupling constant  $J$ . The only distortion from the first-order pattern consists of the gradual reduction of intensities of the outer lines in favour of the inner lines, a characteristic "sloping" or "tenting" towards the coupling partner. A series of simulated spectra of two-spin systems are shown in Figure 5.7.

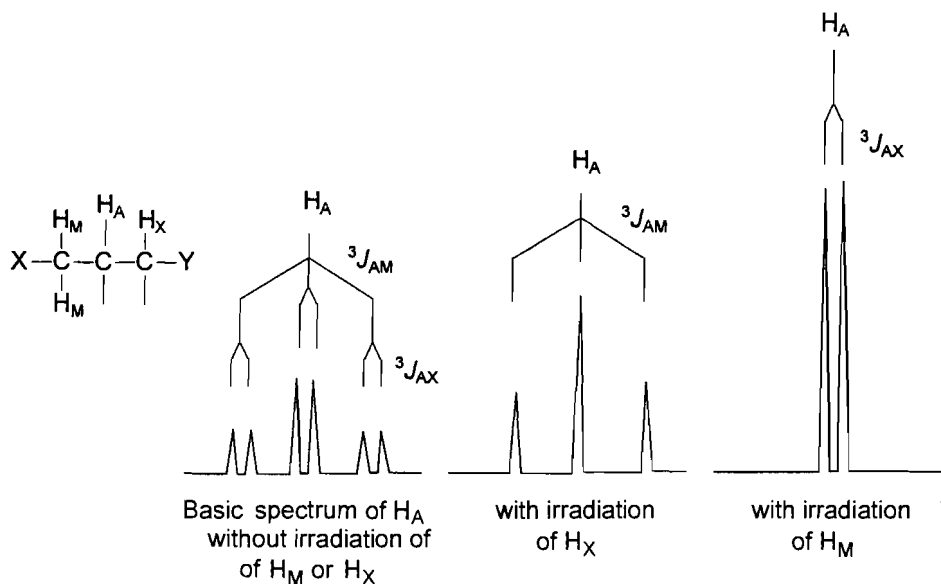

**Figure 5.7** Simulated  $^1\text{H}$  NMR Spectra of a 2-Spin System as the Ratio  $\Delta\nu/J$ , is Varied from 10.0 to 0.0

**(2) Spin Decoupling**

In the signal of a proton that is a multiplet due to spin-spin coupling, it is possible to remove the splitting effects by irradiating the sample with an additional Rf source at the exact resonance frequency of the proton giving rise to the splitting. The additional radiofrequency causes rapid flipping of the irradiated nuclei and as a consequence nuclei coupled to them cannot sense them as being in either an  $\alpha$  or  $\beta$  state for long enough to cause splitting. The irradiated nuclei are said to be **decoupled** from other nuclei in the spin system. Decoupling simplifies the appearance of complex multiplets by removing some of the splittings. In addition, decoupling is a powerful tool for assigning spectra because the skilled spectroscopist can use a series of decoupling experiments to sequentially identify which nuclei are coupled.

In a 4-spin  $AM_2X$  spin system, the signal for proton  $H_A$  would appear as a doublet of triplets (with the triplet splitting due to coupling to the 2 M protons and the doublet splitting due to coupling to the X proton). Irradiation at the frequency of  $H_X$  reduces the multiplicity of the A signal to a triplet (with the remaining splitting due to  $J_{AM}$ ) and irradiation at the frequency of  $H_M$  reduces the multiplicity of the A signal to a doublet (with the remaining splitting due to  $J_{AX}$ ) (Figure 5.8).



**Figure 5.8** Selective Decoupling in a Simple 4-Spin System

### (3) Correlation of $^1\text{H} - ^1\text{H}$ Coupling Constants with Structure

Interproton spin-spin coupling constants are of obvious value in obtaining structural data about a molecule, in particular information about the connectivity of structural elements and the relative disposition of various protons.

#### *Non-aromatic Spin Systems.*

In saturated systems, the magnitude of the *geminal* coupling constant  $^2J_{\text{H-C-H}}$  (two protons attached to the same carbon atom) is typically between 10 and 16 Hz but values between 0 and 22 Hz have been recorded in some unusual structures.

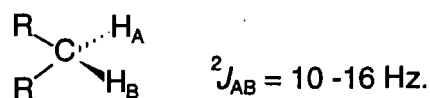

The *vicinal* coupling (protons on adjacent carbon atoms)  $^3J_{\text{H-C-C-H}}$  can have values 0 - 16 Hz depending mainly on the dihedral angle  $\phi$ .

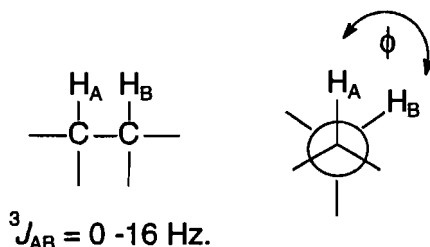

The so-called Karplus relationship expresses **approximately**, the angular dependence of the vicinal coupling constant as:

$$^3J_{\text{H-C-C-H}} = 10 \cos^2 \phi \quad \text{for } 0 < \phi < 90^\circ \text{ and}$$

$$^3J_{\text{H-C-C-H}} = 15 \cos^2 \phi \quad \text{for } 90 < \phi < 180^\circ$$

It follows from these equations that if the dihedral angle  $\phi$  between two vicinal protons is near  $90^\circ$  then the coupling constant will be very small and conversely, if the dihedral angle  $\phi$  between two vicinal protons is near  $0^\circ$  or  $180^\circ$  then the coupling constant will be relatively large. The Karplus relationship is of great value in determining the stereochemistry of organic molecules but must be treated with caution because vicinal coupling constants also depend markedly on the nature of substituents. In systems that assume an average conformation, such as a flexible hydrocarbon chain,  $^3J_{\text{H-H}}$  generally lies between 6 and 8 Hz.

The coupling constants in unsaturated (olefinic) systems depend on the nature of the substituents attached to the C=C but for the vast majority of substituents, the ranges for  $^3J_{\text{H-C=C-H}(cis)}$  and  $^3J_{\text{H-C=C-H}(trans)}$  do not overlap. This means that the stereochemistry of the double bond can be determined by measuring the coupling constant between vinylic protons. Where the C=C bond is in a ring, the  $^3J_{\text{H-C=C-H}}$  coupling reflects the ring size.

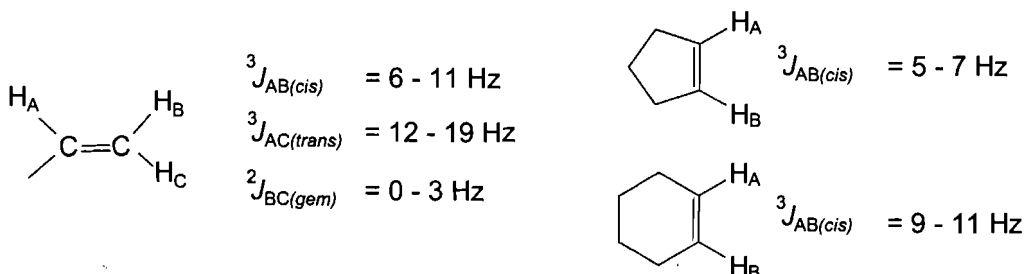

The magnitude of the long-range allylic coupling, ( $^4J_{AB}$ ) is controlled by the dihedral angle between the C-H<sub>A</sub> bond and the plane of the double bond in a relationship reminiscent of the Karplus relation.

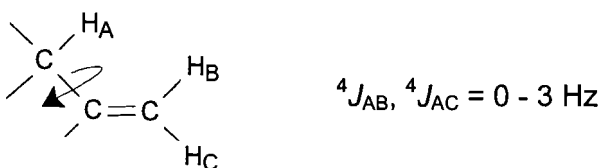

### Aromatic Spin Systems

In aromatic systems, the coupling constant between protons attached to an aromatic ring is characteristic of the relative position of the coupled protons *i.e.* whether they are *ortho*, *meta* or *para*.

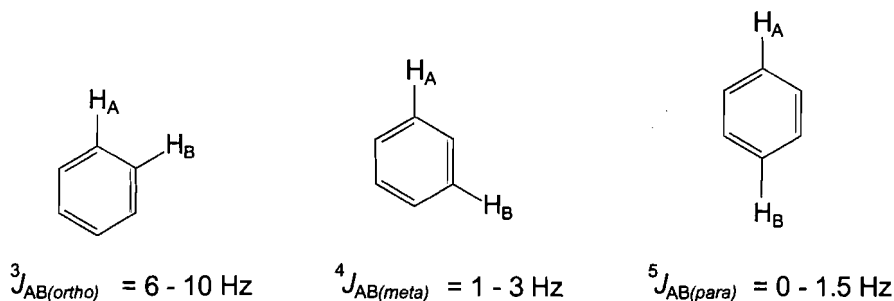

Similarly in condensed polynuclear aromatic compounds and heterocyclic compounds, the magnitude of the coupling constants between protons in the aromatic rings reflects the relative position of the coupled protons.

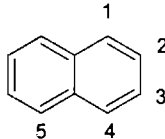
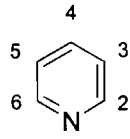
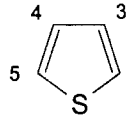
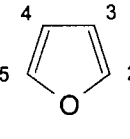

			
${}^3J_{1,2} = 8.3 - 9.1 \text{ Hz}$	${}^3J_{2,3} = 4.0 - 5.7 \text{ Hz}$	${}^3J_{2,3} = 4.7 \text{ Hz}$	${}^3J_{2,3} = 1.8 \text{ Hz}$
${}^3J_{2,3} = 6.1 - 6.9 \text{ Hz}$	${}^3J_{3,4} = 6.8 - 9.1 \text{ Hz}$	${}^3J_{3,4} = 3.4 \text{ Hz}$	${}^3J_{3,4} = 3.5 \text{ Hz}$
${}^4J_{1,3} = 1.2 - 1.6 \text{ Hz}$	${}^4J_{2,4} = 0.0 - 2.5 \text{ Hz}$	${}^4J_{2,4} = 1.0 \text{ Hz}$	${}^4J_{2,4} = 0.8 \text{ Hz}$
${}^5J_{1,4} = 0 - 1.0 \text{ Hz}$	${}^4J_{3,5} = 0.5 - 1.8 \text{ Hz}$	${}^4J_{2,5} = 2.9 \text{ Hz}$	${}^4J_{2,5} = 1.6 \text{ Hz}$
${}^5J_{1,5} = 0 - 1.5 \text{ Hz}$	${}^4J_{2,6} = 0.0 - 0.6 \text{ Hz}$		
	${}^5J_{2,5} = 0.0 - 2.3 \text{ Hz}$		

The splitting patterns of the protons in the aromatic region of the  ${}^1\text{H}$  spectrum are frequently used to establish the substitution pattern of an aromatic ring. For example, a trisubstituted aromatic ring has 3 remaining protons. There are 3 possible arrangements for the 3 protons - they can have relative positions 1,2,3-; 1,2,4-; or 1,3,5- and each has a **characteristic splitting pattern**.

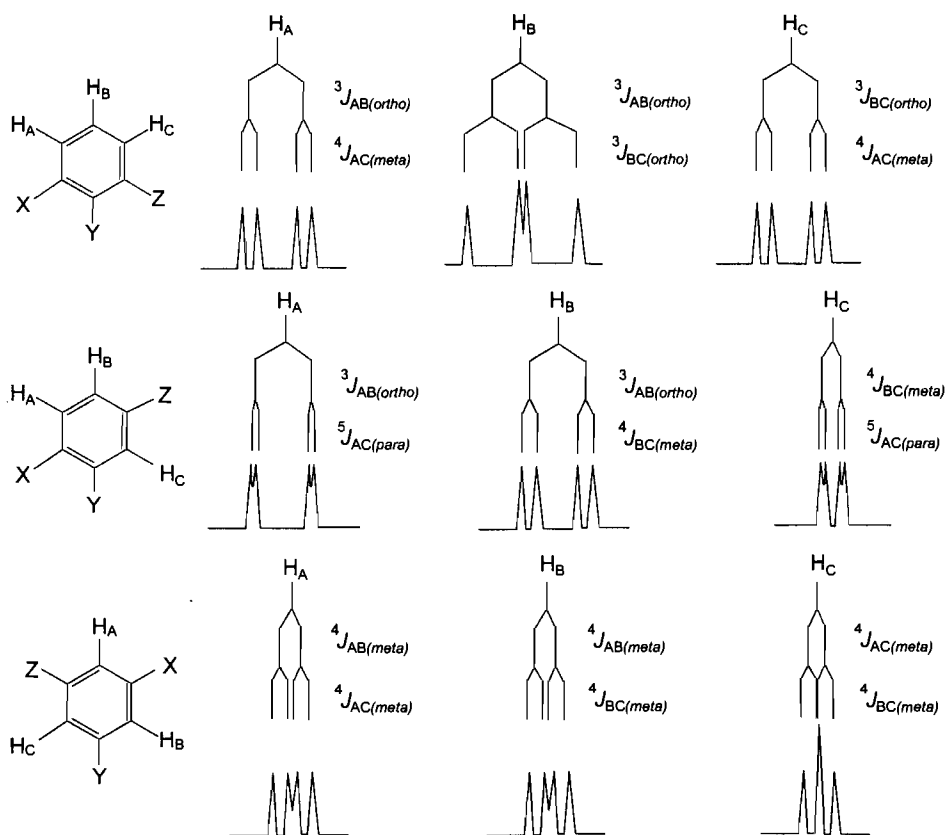

***para-Disubstituted benzenes***

*para*-Disubstituted benzenes have characteristically “simple” and symmetrical  $^1\text{H}$  NMR spectra in the aromatic region. Superficially, the spectra of *p*-disubstituted benzenes always appear as two strong doublets with the line positions symmetrically disposed about a central frequency. The spectra are in fact far more complex (many lines make up the pattern for the NMR spectrum when it is analysed in detail) but the symmetry of the pattern of lines makes 1,4-disubstituted benzenes very easy to recognise from their  $^1\text{H}$  NMR spectra. The  $^1\text{H}$  NMR spectrum of *p*-nitrophenylacetylene is given in Figure 5.9. The expanded section shows the 4 strong prominent signals in the aromatic region, characteristic of 1,4-substitution on a benzene ring.

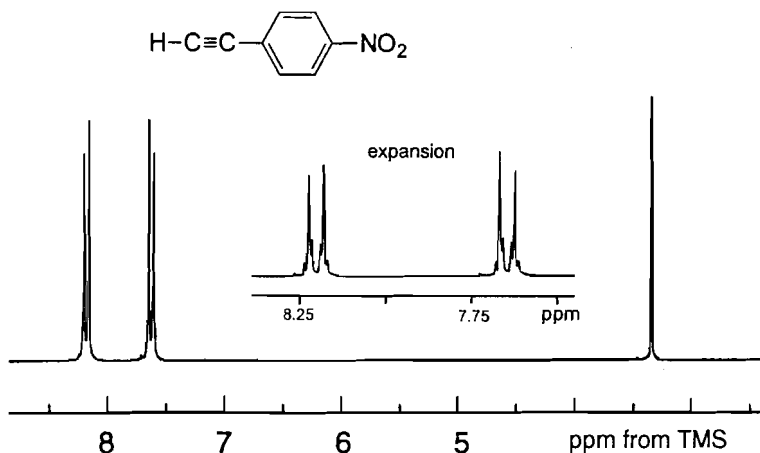

**Figure 5.9**  $^1\text{H}$  NMR Spectrum of *p*-Nitrophenylacetylene (200 MHz as a 10% solution in  $\text{CDCl}_3$ )

## 6

 $^{13}\text{C}$  NMR SPECTROSCOPY

The most abundant isotope of carbon ( $^{12}\text{C}$ ) cannot be observed by NMR.  $^{13}\text{C}$  is a rare nucleus (1.1% natural abundance) and its low concentration coupled with the fact that  $^{13}\text{C}$  has a relatively low resonance frequency, leads to its relative insensitivity as an NMR-active nucleus (about 1/6000 as sensitive as  $^1\text{H}$ ). However, with the increasing availability of routine pulsed FT NMR spectrometers, it is now common to acquire many spectra and add them together (Section 5.3), so  $^{13}\text{C}$  NMR spectra of good quality can be obtained readily.

6.1 COUPLING AND DECOUPLING IN  $^{13}\text{C}$  NMR SPECTRA

Because the  $^{13}\text{C}$  nucleus is isotopically rare, it is extremely unlikely that any two adjacent carbon atoms in a molecule will *both* be  $^{13}\text{C}$ . As a consequence,  **$^{13}\text{C}$ - $^{13}\text{C}$  coupling is not observed** in  $^{13}\text{C}$  NMR spectra *i.e.* there is no signal multiplicity or splitting in a  $^{13}\text{C}$  NMR spectrum due  $^{13}\text{C}$ - $^{13}\text{C}$  coupling.  $^{13}\text{C}$  couples strongly to any protons that may be attached ( $^1J_{\text{CH}}$  is typically about 125 Hz for saturated carbon atoms in organic molecules). It is the usual practice to irradiate the  $^1\text{H}$  nuclei during  $^{13}\text{C}$  acquisition so that all  $^1\text{H}$  are fully decoupled from the  $^{13}\text{C}$  nuclei (usually termed **broad band decoupling** or **noise decoupling**).  **$^{13}\text{C}$  NMR spectra usually appear as a series of singlets** (when  $^1\text{H}$  is fully decoupled) and *each distinct  $^{13}\text{C}$  environment in the molecule gives rise to a separate signal.*

If  $^1\text{H}$  is **not decoupled** from the  $^{13}\text{C}$  nuclei during acquisition, the signals in the  $^{13}\text{C}$  spectrum appear as multiplets where the major splittings are due to the  $^1J_{\text{C-H}}$  couplings (about 125 Hz for  $sp^3$  hybridised carbon atoms, about 160 Hz for  $sp^2$  hybridised carbon atoms, about 250 Hz for  $sp$  hybridised carbon atoms).  $\text{CH}_3$ - signals appear as quartets,  $-\text{CH}_2-$  signals appear as triplets,  $-\text{CH}-$  groups appear as doublets and quaternary C (no attached H) appear as singlets. The **multiplicity information**, taken together with chemical shift data, is useful in identifying and assigning the  $^{13}\text{C}$  resonances.

In  $^{13}\text{C}$  spectra acquired without proton decoupling, there is usually much more “*long range*” coupling information visible in the fine structure of each multiplet. The fine structure arises from coupling between the carbon and protons that are not directly bonded to it (e.g. from  $^2J_{\text{C-C-H}}$ ,  $^3J_{\text{C-C-C-H}}$ ). The magnitude of long range C-H coupling is typically  $< 10$  Hz and this is much less than  $^1J_{\text{C-H}}$ . Sometimes a more detailed analysis of the long-range C-H couplings can be used to provide additional information about the structure of the molecule.

In most  $^{13}\text{C}$  spectra,  $^{13}\text{C}$  nuclei which have directly attached protons receive a significant (but not easily predictable) signal enhancement when the protons are decoupled as a result of the Nuclear Overhauser Effect (see Section 7.3) and as a consequence, peak intensity does not necessarily reflect the number of  $^{13}\text{C}$  nuclei giving rise to the signal.

It is not usually possible to integrate routine  $^{13}\text{C}$  spectra directly unless specific precautions have been taken. However with proper controls,  $^{13}\text{C}$  NMR spectroscopy can be used quantitatively and it is a valuable technique for the analysis of mixtures. To record  $^{13}\text{C}$  NMR spectra where the relative signal intensity can be reliably determined, the spectra must be recorded with techniques to suppress the Nuclear Overhauser Effect and with a long delay between the acquisition of successive spectra to ensure that all of the carbons in the molecule are completely relaxed between spectral acquisitions.

**SFORD : Off- resonance decoupling.** Another method for obtaining  $^{13}\text{C}$  NMR spectra (still retaining the multiplicity information) involves the application of a strong decoupling signal at a single frequency *just outside* the range of proton resonances. This has the effect of incompletely or partially decoupling protons from the  $^{13}\text{C}$  nuclei. The technique is usually referred to as *off resonance decoupling* or SFORD (Single Frequency Off Resonance Decoupling). When a SFORD spectrum is acquired, the effect on the  $^{13}\text{C}$  spectrum is to *reduce* the values of splittings due to all carbon-proton coupling (Figure 6.1d). The multiplicity due to the larger one-bond C-H couplings remains, making it possible to distinguish by inspection whether a carbon atom is a part of a methyl group (quartet), methylene group (triplet), a methine (CH) group (doublet) or a quaternary carbon (a singlet) just as in the fully proton-coupled spectrum. It should be noted that because the protons are partially decoupled, the magnitude of the splittings observed in the signals in a SFORD  $^{13}\text{C}$  NMR spectrum is not the C-H coupling constant (the splittings are always less than the real coupling constants). SFORD spectra are useful only to establish signal multiplicity.

## 6.2 DETERMINING $^{13}\text{C}$ SIGNAL MULTIPLICITY USING DEPT

With most modern NMR instrumentation, the DEPT experiment (**D**istortionless **E**nhancement by **P**olarisation **T**ransfer) is the most commonly used method to determine the multiplicity of  $^{13}\text{C}$  signals. The DEPT experiment is a pulsed NMR experiment which requires a series of programmed Rf pulses to both the  $^1\text{H}$  and  $^{13}\text{C}$  nuclei in a sample. The resulting  $^{13}\text{C}$  DEPT spectrum contains only signals arising from protonated carbons (non protonated carbons do not give signals in the  $^{13}\text{C}$  DEPT spectrum). The signals arising from carbons in  $\text{CH}_3$  and  $\text{CH}$  groups (*i.e.* those with an odd number of attached protons) appear oppositely phased from those in  $\text{CH}_2$  groups (*i.e.* those with an even number of attached protons) so signals from  $\text{CH}_3$  and  $\text{CH}$  groups point upwards while signals from  $\text{CH}_2$  groups point downwards (Figure 6.1b).

In more advanced applications, the  $^{13}\text{C}$  DEPT experiment can be used to separate the signals arising from carbons in  $\text{CH}_3$ ,  $\text{CH}_2$  and  $\text{CH}$  groups. This is termed spectral editing and can be used to produce separate  $^{13}\text{C}$  sub-spectra of just the  $\text{CH}_3$  carbons, just the  $\text{CH}_2$  carbons or just the  $\text{CH}$  carbons.

Figure 6.1 shows various  $^{13}\text{C}$  spectra of methyl cyclopropyl ketone. The  $^{13}\text{C}$  spectrum acquired with full proton decoupling (Figure 6.1a) shows 4 singlet peaks, one for each of the 4 different carbon environments in the molecule. The DEPT spectrum (Figure 6.1b) shows only the 3 resonances for the protonated carbons. The carbon atoms that have an odd number of attached hydrogens ( $\text{CH}$  and  $\text{CH}_3$  groups) point upwards and those with an even number of attached hydrogen atoms (the signals of  $\text{CH}_2$  groups) point downwards. Note that the carbonyl carbon does not appear in the DEPT spectrum since it has no attached protons.

In the carbon spectrum with no proton decoupling (Figure 6.1c), all of the resonances of protonated carbons appear as multiplets and the multiplet structure is due to coupling to the attached protons. The  $\text{CH}_3$  (methyl) group appears as a quartet, the  $\text{CH}_2$  (methylene) groups appear as a triplet and the  $\text{CH}$  (methine) group appears as a doublet while the carbonyl carbon (with no attached protons) appears as a singlet. In Figure 6.1c, all of the  $^1J_{\text{C-H}}$  coupling constants could be measured directly from the spectrum. The SFORD spectrum (Figure 6.1d) shows the expected multiplicity for all of the resonances but the multiplets are narrower due to partial decoupling of the protons and the splittings are less than the true values of  $^1J_{\text{C-H}}$ .

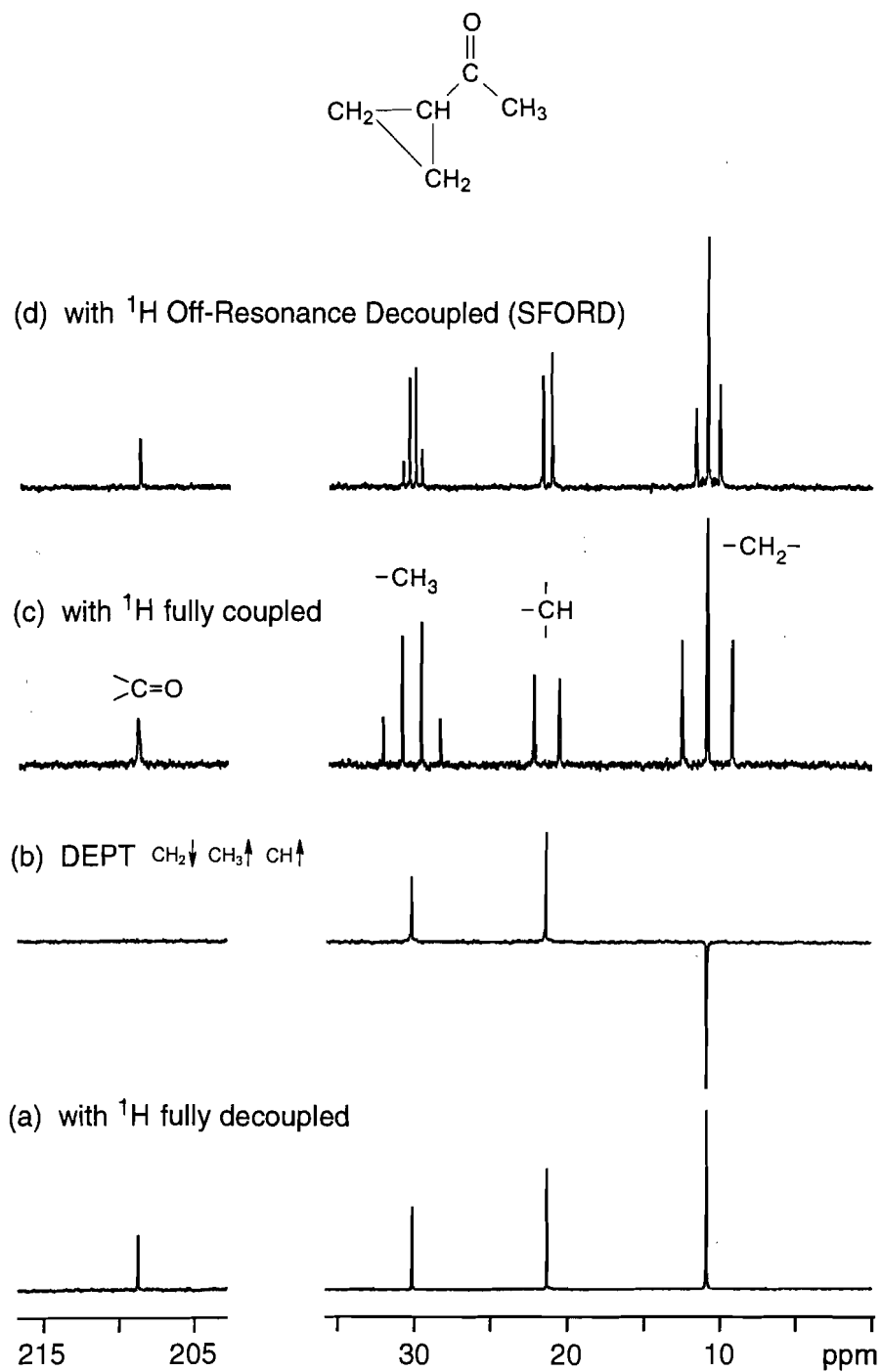
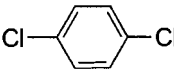
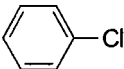
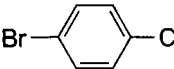
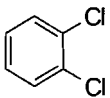
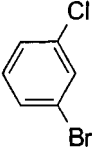
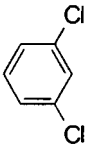
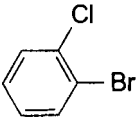

**Figure 6.1**  $^{13}\text{C}$  NMR Spectra of Methyl Cyclopropyl Ketone ( $\text{CDCl}_3$  Solvent, 100 MHz). (a) Spectrum with Full Broad Band Decoupling of  $^1\text{H}$ ; (b) DEPT Spectrum (c) Spectrum with no Decoupling of  $^1\text{H}$ ; (d) SFORD Spectrum

For purposes of assigning a  $^{13}\text{C}$  spectrum, two  $^{13}\text{C}$  spectra are usually obtained. Firstly, a spectrum with complete  $^1\text{H}$  decoupling to maximise the intensity of signals and provide sharp singlets signals to minimise any signal overlap. This is the best spectrum to **count the number of resonances** and accurately determine their chemical shifts. Secondly, a spectrum which is sensitive to the number of protons attached to each C to permit partial **sorting of the  $^{13}\text{C}$  signals** according to whether they are methyl, methylene, methine or quaternary carbon atoms. This could be a DEPT spectrum, a  $^{13}\text{C}$  spectrum with no proton decoupling or a SFORD spectrum.

The number of resonances visible in a  $^{13}\text{C}$  NMR spectrum immediately indicates **the number of distinct  $^{13}\text{C}$  environments in the molecule** (Table 6.1). If the number of  $^{13}\text{C}$  environments is less than the number of carbons in the molecule, then the molecule must have some symmetry that dictates that some  $^{13}\text{C}$  nuclei are in identical environments. This is particularly useful in establishing the **substitution pattern** (position where substituents are attached) in aromatic compounds.

**Table 6.1 The Number of Aromatic  $^{13}\text{C}$  Resonances in Benzenes with Different Substitution Patterns**

Molecule	Number of aromatic $^{13}\text{C}$ resonances	Molecule	Number of aromatic $^{13}\text{C}$ resonances
	1		2
	4		4
	3		6
	4		6

### 6.3 SHIELDING AND CHARACTERISTIC CHEMICAL SHIFTS IN $^{13}\text{C}$ NMR SPECTRA

The general trends of  $^{13}\text{C}$  chemical shifts somewhat parallel those in  $^1\text{H}$  NMR spectra. However,  $^{13}\text{C}$  nuclei have access to a greater variety of hybridisation states (bonding geometries and electron distributions) than  $^1\text{H}$  nuclei and both hybridisation and changes in electron density have a significantly larger effect on  $^{13}\text{C}$  nuclei than  $^1\text{H}$  nuclei. As a consequence, the  $^{13}\text{C}$  chemical shift scale spans some 250 ppm, *cf.* the 10 ppm range commonly encountered for  $^1\text{H}$  chemical shifts (Tables 6.2 and 6.3).

**Table 6.2** Typical  $^{13}\text{C}$  Chemical Shift Values in Selected Organic Compounds

Compound	$\delta^{13}\text{C}$ (ppm from TMS)
$\text{CH}_4$	-2.1
$\text{CH}_3\text{CH}_3$	7.3
$\text{CH}_3\text{OH}$	50.2
$\text{CH}_3\text{Cl}$	25.6
$\text{CH}_2\text{Cl}_2$	52.9
$\text{CHCl}_3$	77.3
$\text{CH}_3\text{CH}_2\text{CH}_2\text{Cl}$	11.5 ( $\text{CH}_3$ ) 26.5 ( $-\text{CH}_2-$ ) 46.7 ( $-\text{CH}_2-\text{Cl}$ )
$\text{CH}_2=\text{CH}_2$	123.3
$\text{CH}_2=\text{C}=\text{CH}_2$	208.5 ( $=\text{C}=\text{}$ ) 73.9 ( $=\text{CH}_2$ )
$\text{CH}_3\text{CHO}$	31.2 ( $-\text{CH}_3$ ) 200.5 ( $-\text{CHO}$ )
$\text{CH}_3\text{COOH}$	20.6 ( $-\text{CH}_3$ ), 178.1 ( $-\text{COOH}$ )
$\text{CH}_3\text{COCH}_3$	30.7 ( $-\text{CH}_3$ ), 206.7 ( $-\text{CO}-$ )
	128.5
	149.8 (C-2) 123.7 (C-3) 135.9 (C4)



Table 6.3 Typical  $^{13}\text{C}$  Chemical Shift Ranges in Organic Compounds

Group	$^{13}\text{C}$ shift (ppm)
TMS	0.0
$-\text{CH}_3$ (with only -H or -R at $\text{C}_\alpha$ and $\text{C}_\beta$ )	0 - 30
$-\text{CH}_2$ (with only -H or -R at $\text{C}_\alpha$ and $\text{C}_\beta$ )	20 - 45
$-\text{CH}$ (with only -H or -R at $\text{C}_\alpha$ and $\text{C}_\beta$ )	30 - 60
C quaternary (with only -H or -R at $\text{C}_\alpha$ and $\text{C}_\beta$ )	30 - 50
O- $\text{CH}_3$	50 - 60
N- $\text{CH}_3$	15 - 45
$\text{C}\equiv\text{C}$	70 - 95
$\text{C}=\text{C}$	105 - 145
C (aromatic)	110 - 155
C (heteroaromatic)	105 - 165
$-\text{C}\equiv\text{N}$	115 - 125
$\text{C}=\text{O}$ (acids, acyl halides, esters, amides)	155 - 185
$\text{C}=\text{O}$ (aldehydes, ketones)	185 - 225

In  $^{13}\text{C}$  NMR spectroscopy the  $^{13}\text{C}$  signal due to the carbon in  $\text{CDCl}_3$  appears as a triplet centred at  $\delta$  77.3 with peaks intensities in the ratio 1:1:1 (due to spin-spin coupling between  $^{13}\text{C}$  and  $^2\text{H}$ ). This resonance serves as a convenient reference for the chemical shifts of  $^{13}\text{C}$  NMR spectra recorded in this solvent.

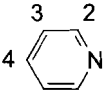
Table 6.4 gives characteristic  $^{13}\text{C}$  chemical shifts for some  $sp^3$ -hybridised carbon atoms in common functional groups. Table 6.5 gives characteristic  $^{13}\text{C}$  chemical shifts for some  $sp^2$ -hybridised carbon atoms in substituted alkenes and Table 6.6 gives characteristic  $^{13}\text{C}$  chemical shifts for some  $sp$ -hybridised carbon atoms in alkynes.

Table 6.4  $^{13}\text{C}$  Chemical Shifts ( $\delta$ ) for  $sp^3$  Carbons in Alkyl Derivatives

X	CH <sub>3</sub> —X	CH <sub>3</sub> CH <sub>2</sub> —X		(CH <sub>3</sub> ) <sub>2</sub> CH—X	
	—CH <sub>3</sub>	—CH <sub>3</sub>	—CH <sub>2</sub> —	—CH <sub>3</sub>	>CH—
—H	-2.3	7.3	7.3	15.4	15.9
—CH=CH <sub>2</sub>	18.7	13.4	27.4	22.1	32.3
—Ph	21.4	15.8	29.1	24.0	34.3
—Cl	25.6	18.9	39.9	27.3	53.7
—OH	50.2	18.2	57.8	25.3	64.0
—OCH <sub>3</sub>	60.9	14.7	67.7	21.4	72.6
—OCO—CH <sub>3</sub>	51.5	14.4	60.4	21.9	67.5
—CO—CH <sub>3</sub>	30.7	7.0	35.2	18.2	41.6
—CO—OCH <sub>3</sub>	20.6	9.2	27.2	19.1	34.1
—NH <sub>2</sub>	28.3	19.0	36.9	26.5	43.0
—NH—COCH <sub>3</sub>	26.1	14.6	34.1	22.3	40.5
—C≡N	1.7	10.6	10.8	19.9	19.8
—NO <sub>2</sub>	61.2	12.3	70.8	20.8	78.8

Table 6.5  $^{13}\text{C}$  Chemical Shifts ( $\delta$ ) for  $sp^2$  Carbons in Vinyl Derivatives: CH<sub>2</sub>=CH-X

X	CH <sub>2</sub> =	=CH—X
—H	123.3	123.3
—CH <sub>3</sub>	115.9	136.2
—C(CH <sub>3</sub> ) <sub>3</sub>	108.9	149.8
—Ph	112.3	135.8
—CH=CH <sub>2</sub>	116.3	136.9
—C≡C—H	129.2	117.3
—CO—CH <sub>3</sub>	128.0	137.1
—CO—OCH <sub>3</sub>	130.3	129.6
—Cl	117.2	126.1
—OCH <sub>3</sub>	84.4	152.7
—OCO—CH <sub>3</sub>	96.6	141.7
—C≡N	137.5	108.2
—NO <sub>2</sub>	122.4	145.6
—N(CH <sub>3</sub> ) <sub>2</sub>	91.3	151.3

**Table 6.6**  $^{13}\text{C}$  Chemical Shifts ( $\delta$ ) for  $sp$  Carbons in Alkynes:  
 $\text{X}-\text{C}\equiv\text{C}-\text{Y}$

X	Y	$\text{X}-\text{C}\equiv$	$\equiv\text{C}-\text{Y}$
H—	—H	73.2	73.2
H—	— $\text{CH}_3$	66.9	79.2
H—	— $\text{C}(\text{CH}_3)_3$	67.0	92.3
H—	— $\text{CH}=\text{CH}_2$	80.0	82.8
H—	— $\text{C}\equiv\text{C}-\text{H}$	66.3	67.3
H—	—Ph	77.1	83.4
H—	— $\text{COCH}_3$	81.8	78.1
H—	— $\text{OCH}_2\text{CH}_3$	22.0	88.2
$\text{CH}_3$ —	— $\text{CH}_3$	72.6	72.6
$\text{CH}_3$ —	—Ph	79.7	85.8
$\text{CH}_3$ —	— $\text{COCH}_3$	97.4	87.0
Ph—	—Ph	89.4	89.4
— $\text{COOCH}_3$	— $\text{COOCH}_3$	74.6	74.6

Table 6.7 gives characteristic  $^{13}\text{C}$  chemical shifts for the aromatic carbons in benzene derivatives. To a first approximation, the shifts induced by substituents are additive. So, for example, an aromatic carbon which has a  $-\text{NO}_2$  group in the *para* position and a  $-\text{Br}$  group in the *ortho* position will appear at approximately 137.9 ppm [(128.5 + 6.1(*p*- $\text{NO}_2$ ) + 3.3(*o*-Br)].

**Table 6.7** Approximate  $^{13}\text{C}$  Chemical Shifts ( $\delta$ ) for Aromatic Carbons in Benzene Derivatives Ph-X in ppm relative to Benzene at  $\delta$  128.5 ppm (a positive sign denotes a downfield shift)

X	<i>ipso</i>	<i>ortho</i>	<i>meta</i>	<i>para</i>
—H	0.0	0.0	0.0	0.0
—NO <sub>2</sub>	19.9	-4.9	0.9	6.1
—CO—OCH <sub>3</sub>	2.0	1.2	-0.1	4.3
—CO—NH <sub>2</sub>	5.0	-1.2	0.1	3.4
—CO—CH <sub>3</sub>	8.9	0.1	-0.1	4.4
—C≡N	-16.0	3.5	0.7	4.3
—Br	-5.4	3.3	2.2	-1.0
—CH=CH <sub>2</sub>	8.9	-2.3	-0.1	-0.8
—Cl	5.3	0.4	1.4	-1.9
—CH <sub>3</sub>	9.2	0.7	-0.1	-3.0
—OCO—CH <sub>3</sub>	22.4	-7.1	0.4	-3.2
—OCH <sub>3</sub>	33.5	-14.4	1.0	-7.7
—NH <sub>2</sub>	18.2	-13.4	0.8	-10.0

Tables 6.8 gives characteristic shifts for  $^{13}\text{C}$  nuclei in some polynuclear aromatic compounds and heteroaromatic compounds.

**Table 6.8** Characteristic  $^{13}\text{C}$  Chemical Shifts ( $\delta$ ) in some Polynuclear Aromatic Compounds and Heteroaromatic Compounds

## 7

## MISCELLANEOUS TOPICS

This section deals briefly with a number of more advanced topics in NMR spectroscopy, which indicate of the power of NMR spectroscopy in solving complex structural problems.

## 7.1 DYNAMIC NMR SPECTROSCOPY: THE NMR TIME-SCALE

Two magnetic nuclei situated in different molecular environments must give rise to separate signals in the NMR spectrum, say  $\Delta\nu$  Hz apart (Figure 7.1a). However, if some process interchanges the environments of the two nuclei at a rate ( $k$ ) much faster than  $\Delta\nu$  times per second, the two nuclei will be observed as a single signal at an intermediate frequency (Figures 7.1d and 7.1e). When the rates ( $k$ ) of the exchange process are comparable to  $\Delta\nu$ , *exchange broadened* spectra (Figure 7.1b) are observed. From the exchange broadened spectra, the rate constants for the exchange process (and hence the activation parameters  $\Delta G^\ddagger$ ,  $\Delta H^\ddagger$ ,  $\Delta S^\ddagger$ ) can be derived. Where signals coalesce (Figure 7.1c) from being two separate signals to a single averaged signal, the rate constant for the exchange can be approximated as  $k = \pi \cdot \Delta\nu / \sqrt{2}$ .

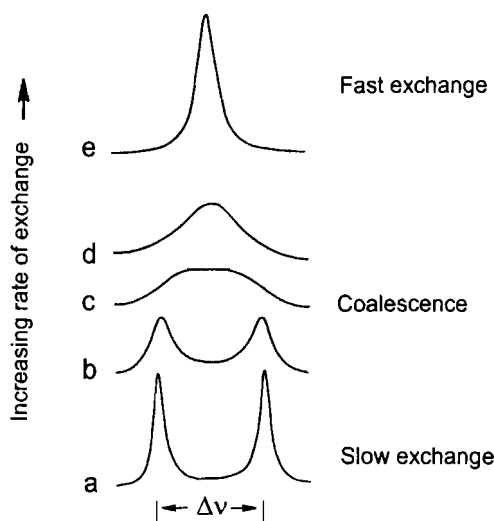

Figure 7.1 Schematic NMR Spectra of Two Exchanging Nuclei

In practice, a compound where an exchange process operates can give rise to a series of spectra of the type shown in Figure 7.1, if the NMR spectra are recorded at different temperatures. Changing the sample temperature alters the rate constant for the exchange (increasing the temperature increases the rate of an exchange process) and the spectra will have a different appearance depending on whether the rate constant,  $k$  (expressed in  $\text{sec}^{-1}$ ) is large or small compared to the chemical shift differences between exchanging nuclei ( $\Delta\nu$  expressed in Hz). *Molecules where there are exchange processes taking place may also give rise to different NMR spectra in different NMR spectrometers* because  $\Delta\nu$  depends on the strength of the magnetic field. An NMR spectrum which shows exchange broadening will tend to give a slow exchange spectrum if the spectrum is re-run in a spectrometer with a stronger magnetic field.

The averaging effects of exchange apply to any dynamic process that takes place in a molecule (or between molecules). However, many processes occur at rates that are too fast or too slow to give rise to visible broadening of NMR spectra. The **NMR time-scale** happens to coincide with the rates of a number of common chemical processes that give rise to variation of the appearance of NMR spectra with temperature and these include:

(1) **Conformational exchange processes.** Conformational processes can give rise to exchange broadening in NMR spectra when a molecule exchanges between two or more conformations. Fortunately most conformational processes are so fast on the NMR time-scale that normally only averaged spectra are observed. In particular, in molecules which are not unusually sterically bulky, the rotation about C-C single bonds is normally fast on the NMR time scale so, for example, the 3 hydrogen atoms of a methyl group appear as a singlet as a result of averaging of the various rotational conformers.

In molecules where there are very bulky groups, steric hindrance can slow the rotation about single bonds and give rise to broadening in NMR spectra. In molecules containing rings, the exchange between various ring conformations (*e.g.* chair-boat-chair) can exchange nuclei.

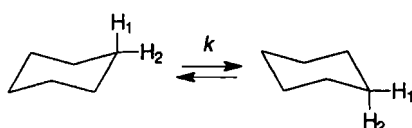

For example, cyclohexane gives a single averaged resonance in the  $^1\text{H}$  NMR at room temperature, but separate signals are seen for the axial and equatorial hydrogens when spectra are acquired at very low temperature.

(2) *Intermolecular interchange of labile (slightly acidic) protons.* Functional groups such as -OH, -COOH, -NH<sub>2</sub> and -SH have labile protons which exchange with each other in solution. The -OH protons of a mixture of two different alcohols may give rise to either an averaged signal or to separate signals depending on the rate of exchange and this depends on many factors including temperature, the polarity of the solvent, the concentrations of the solutes and the presence of acidic or basic catalysts.

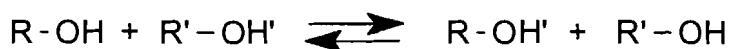

(3) *Rotation about partial double bonds.*

Exchange broadening is frequently observed in amides due to restricted rotation about the N-C bond of the amide group.

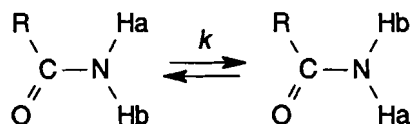

The restricted rotation about amide bonds often occurs at a rate that gives rise to observable broadening in NMR spectra.

The restricted rotation in amide bonds results from the partial double bond character of the C-N bond.

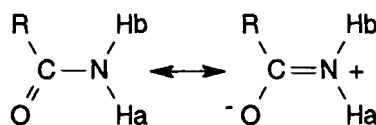

## 7.2 THE EFFECT OF CHIRALITY

In an achiral solvent, enantiomers will give identical NMR spectra. However in a chiral solvent or in the presence of a chiral additive to the NMR solvent, enantiomers will have different spectra and this is frequently used to establish the enantiomeric purity of compounds. The resonances of one enantiomer can be integrated against the resonances of the other to quantify the enantiomeric purity of a compound.

In molecules that contain a stereogenic centre, the NMR spectra can sometimes be more complex than would otherwise be expected. Groups such as -CH<sub>2</sub>- groups (or any -CX<sub>2</sub>- group such as -C(Me)<sub>2</sub>- or -CR<sub>2</sub>-) require particular attention in molecules which contain a stereogenic centre. The carbon atom of a -CX<sub>2</sub>- group is termed a **prochiral carbon** if there is a stereogenic centre (a chiral centre) elsewhere in the

molecule. A prochiral carbon atom is a carbon in a molecule that would be chiral if one of its substituents was replaced by a different substituent. From an NMR perspective, the important fact is that the presence of stereogenic centre makes the substituents on a prochiral carbon atom **chemically non-equivalent**. So whereas the protons of a  $-\text{CH}_2-$  group in an acyclic aliphatic compound would normally be expected to be equivalent and resonate at the same frequency in the  $^1\text{H}$  NMR spectrum, if there is a stereogenic centre in the molecule, each of the protons of the  $-\text{CH}_2-$  group will appear at different chemical shifts. Also, since they are non-equivalent, the protons will couple to each other typically with a large coupling of about 15 Hz.

The effect of chirality is particularly important in the spectra of natural products including amino acids, proteins or peptides. Many molecules derived from natural sources contain a stereogenic centre and they are typically obtained as a single pure enantiomer. In these molecules, the resonances for all of the methylene groups (*i.e.*  $-\text{CH}_2-$  groups) in the molecule will be complicated by the fact that the two protons of the methylene groups will be non-equivalent. Figure 7.2 shows the aliphatic protons in the  $^1\text{H}$  NMR spectrum of the amino acid cysteine ( $\text{HSCH}_2\text{CHNH}_3^+\text{COO}^-$ ). Cysteine has a stereogenic centre and the signals of the methylene group appear as separate signals at  $\delta$  3.18 and  $\delta$  2.92 ppm. Each of the methylene protons is split into a doublet of doublets due to coupling firstly to the other methylene proton and secondly to the proton on the  $\alpha$ -carbon ( $\text{H}_c$ ).

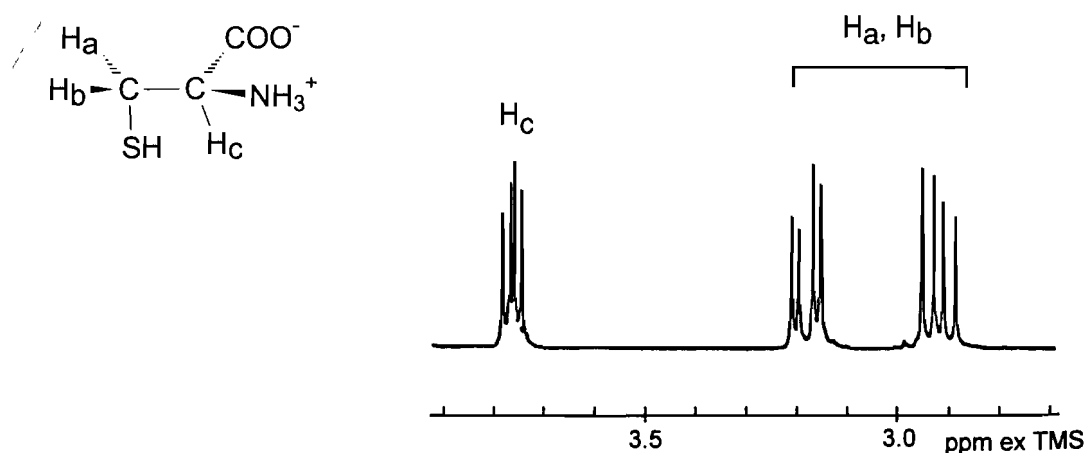

**Figure 7.2**  $^1\text{H}$  NMR Spectrum of the Aliphatic Region of Cysteine Indicating Non-equivalence of the Methylene Protons due to the Influence of the Stereogenic Centre



### 7.3 THE NUCLEAR OVERHAUSER EFFECT (NOE)

Irradiation of one nucleus while observing the resonance of another may result in a change in the **amplitude** of the observed resonance *i.e.* an enhancement of the signal intensity. This is known as the *nuclear Overhauser effect* (NOE). The NOE is a "through space" effect and its magnitude is inversely proportional to the sixth power of the distance between the interacting nuclei. Because of the distance dependence of the NOE, it is an important method for establishing which groups are close together in space and because the NOE can be measured quite accurately it is a very powerful means for determining the three dimensional structure (and stereochemistry) of organic compounds.

The intensity of  $^{13}\text{C}$  resonances may be increased by up to 200% when  $^1\text{H}$  nuclei which are directly bonded to the carbon atom are irradiated. This effect is very important in increasing the intensity of  $^{13}\text{C}$  spectra when they are proton-decoupled. The efficiency of the proton/carbon NOE varies from carbon to carbon and this is a factor that contributes to the generally non-quantitative nature of  $^{13}\text{C}$  NMR. While the intensity of protonated carbon atoms can be increased significantly by NOE, non-protonated carbons (quaternary carbon atoms) receive little NOE and are usually the weakest signals in a  $^{13}\text{C}$  NMR spectrum.

## 7.4 TWO-DIMENSIONAL NMR SPECTROSCOPY

Since the advent of pulsed NMR spectroscopy, a number of advanced two-dimensional techniques have been devised. These methods afford valuable information for the solution of complex structural problems. The technical detail behind multi-dimensional NMR is beyond the scope of this book.

Two-dimensional spectra have the appearance of surfaces, generally with two axes corresponding to chemical shift and the third (vertical) axis corresponding to signal intensity.

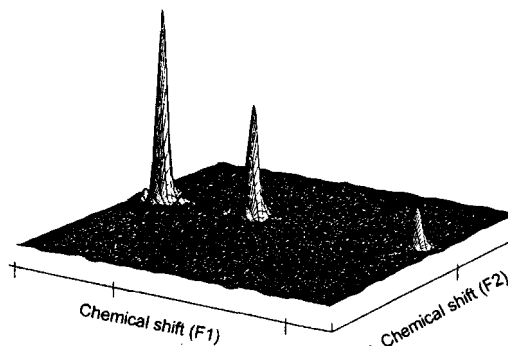

It is usually more useful to plot two-dimensional spectra viewed directly from above (a **contour plot** of the surface) in order to make measurements and assignments.

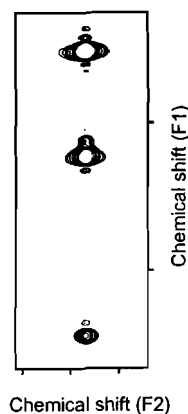

The most important two-dimensional NMR experiments for solving structural problems are COSY (Correlation SpectroscopY), NOESY (Nuclear Overhauser Enhancement SpectroscopY), HSC (Heteronuclear Shift Correlation) and TOCSY (Total Correlation SpectroscopY). Most modern high-field NMR spectrometers have the capability to routinely and automatically acquire COSY, NOESY, HSC and TOCSY spectra.

**The COSY spectrum** shows which pairs of protons in a molecule are coupled to each other. The COSY spectrum is a symmetrical spectrum that has the  $^1\text{H}$  NMR spectrum of the substance as both of the chemical shift axes ( $F_1$  and  $F_2$ ). A schematic representation of COSY spectrum is given below.

It is usual to plot a normal (one-dimensional) NMR spectrum along each of the axes to give reference spectra for the peaks that appear in the two-dimensional spectrum.

The COSY spectrum has a diagonal set of peaks (open circles) as well as peaks that are off the diagonal (filled circles). The off-diagonal peaks are the important signals since these occur at positions where there is coupling between a proton on the  $F_1$  axis and one on the  $F_2$  axis. In the schematic spectrum on the right, the off-diagonal signals show that there is spin-spin coupling between  $\text{H}_\text{C}$  and  $\text{H}_\text{D}$  and also between  $\text{H}_\text{B}$  and  $\text{H}_\text{C}$  but the proton labelled  $\text{H}_\text{A}$  has no coupling partners.

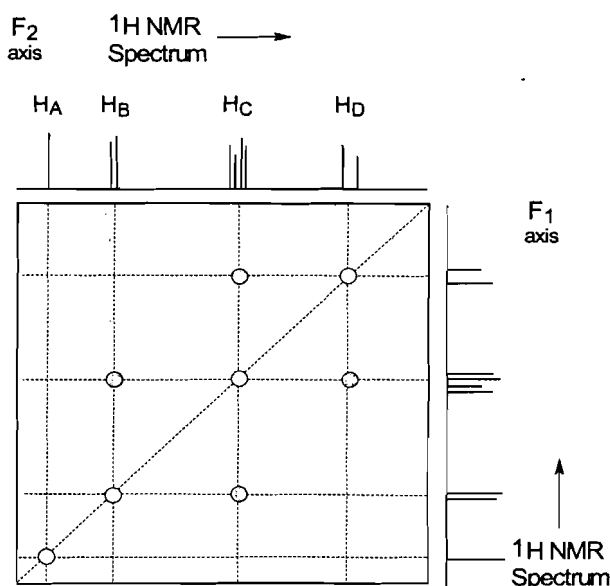

In a single COSY spectrum, all of the spin-spin coupling pathways in a molecule can be identified.

**The NOESY spectrum** relies on the Nuclear Overhauser Effect and shows which pairs of nuclei in a molecule are close together in space. The NOESY spectrum is very similar in appearance to a COSY spectrum. It is a symmetrical spectrum that has the  $^1\text{H}$  NMR spectrum of the substance as both of the chemical shift axes ( $F_1$  and  $F_2$ ). A schematic representation of NOESY spectrum is given below. Again, it is usual to plot a normal (one-dimensional) NMR spectrum along each of the axes to give reference spectra for the peaks that appear in the two-dimensional spectrum.

From the analysis of a NOESY spectrum, it is possible to determine the three dimensional structure of a molecule or parts of a molecule. The NOESY spectrum is particularly useful for establishing the stereochemistry (e.g. the *cis/trans* configuration of a double bond or a ring junction) of a molecule where more than one possible stereoisomer exists.

The NOESY spectrum has a diagonal set of peaks (open circles) as well as peaks which are off the diagonal (filled circles). The off-diagonal peaks occur at positions where a proton on the  $F_1$  axis is close in space to a one on the  $F_2$  axis. In the schematic spectrum on the right, the off-diagonal signals show that  $H_A$  must be located near  $H_D$  and  $H_B$  must be located near  $H_C$ .

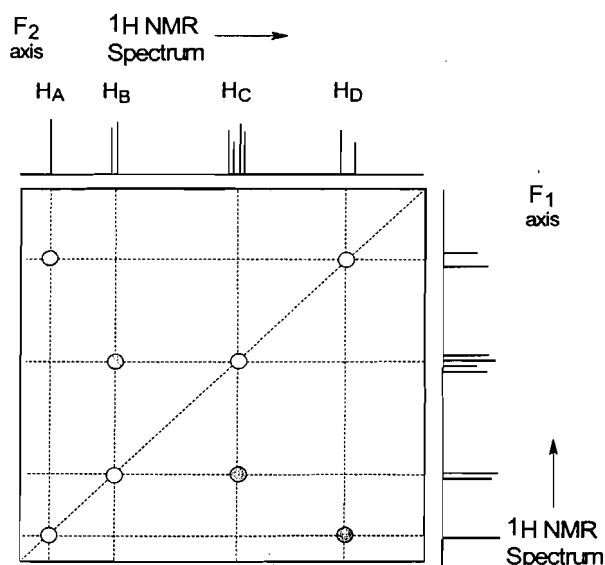

**The HSC spectrum** is the heteronuclear analogue of the COSY spectrum and identifies which protons are coupled to which carbons in the molecule. The HSC spectrum has the  $^1\text{H}$  NMR spectrum of the substance on one axis ( $F_2$ ) and the  $^{13}\text{C}$  spectrum (or the spectrum of some other nucleus) on the second axis ( $F_1$ ). A schematic representation of an HSC spectrum is given below. It is usual to plot a normal (one-dimensional)  $^1\text{H}$  NMR spectrum along the proton dimension and a normal (one-dimensional)  $^{13}\text{C}$  NMR spectrum along the  $^{13}\text{C}$  dimension to give reference spectra for the peaks that appear in the two-dimensional spectrum.

The HSC spectrum does not have diagonal peaks. The peaks in an HSC spectrum occur at positions where a proton in the spectrum on the  $F_2$  axis is coupled to a carbon in the spectrum on the  $F_1$  axis. In the schematic spectrum on the right, both  $H_A$  and  $H_B$  are coupled to  $C_Z$ ,  $H_C$  is coupled to  $C_Y$  and  $H_D$  is coupled to  $C_X$ .

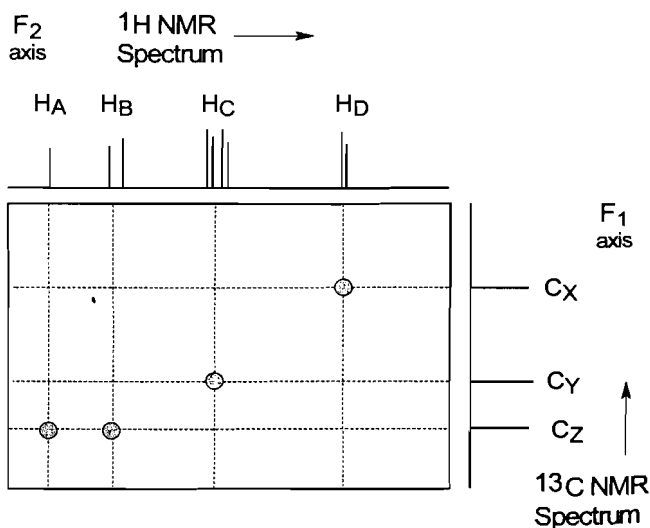

In an HSC spectrum, the correlation between the protons in the  $^1\text{H}$  NMR spectrum and the carbon nuclei in the  $^{13}\text{C}$  spectrum can be obtained. It is usually possible to assign all of the resonances in the  $^1\text{H}$  NMR spectrum *i.e.* establish which proton in a molecule gives rise to each signal in the spectrum, using spin-spin coupling information. The  $^{13}\text{C}$  spectrum can then be assigned by correlation to the proton resonances.

**The TOCSY spectrum** is useful in identifying all of the protons which belong to an isolated spin system. Like the COSY and NOESY spectra, the TOCSY also has peaks along a diagonal at the frequencies of all of the resonances in the spectrum. The experiment relies on spin-spin coupling but rather than showing pairs of nuclei which are directly coupled together, the TOCSY shows a cross peak (off-diagonal peak) for every nucleus which is part of the spin system not just those that are directly coupled.

The TOCSY spectrum is symmetrical about the diagonal and has the  $^1\text{H}$  NMR spectrum of the substance as both of the chemical shift axes ( $F_1$  and  $F_2$ ). A schematic representation of TOCSY spectrum is given below. Again, it is usual to plot a normal (one-dimensional) NMR spectrum along each of the axes to give reference spectra for the peaks that appear in the two-dimensional spectrum.

The TOCSY spectrum has a diagonal set of peaks (open circles) as well as peaks which are off the diagonal (filled circles). The off-diagonal peaks occur at positions where a proton on the  $F_1$  axis is in the same spin system as one on the  $F_2$  axis. In the schematic spectrum on the right, there are two superimposed isolated 3-spin systems ( $\text{H}_{\text{A}1}$ ,  $\text{H}_{\text{A}2}$ ,  $\text{H}_{\text{A}3}$ ) and ( $\text{H}_{\text{X}1}$ ,  $\text{H}_{\text{X}2}$ ,  $\text{H}_{\text{X}3}$ ) and the cross peaks clearly indicate which resonances belong to each spin system.

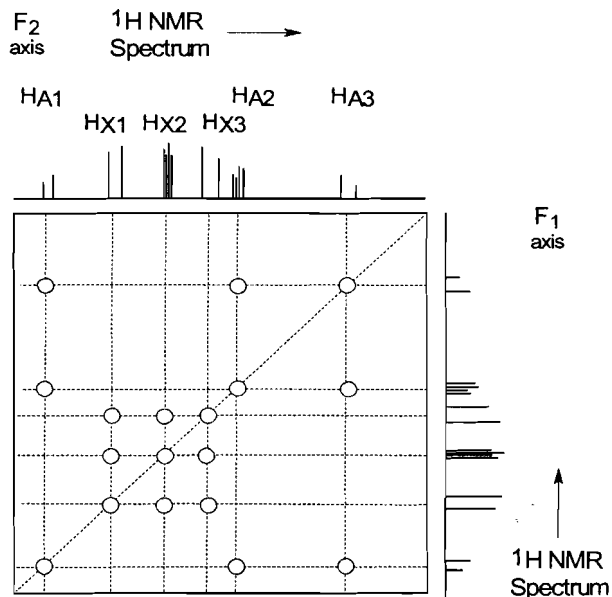

## 7.5 THE NMR SPECTRA OF "OTHER NUCLEI"

$^1\text{H}$  and  $^{13}\text{C}$  NMR spectroscopy accounts for the overwhelming proportion of all NMR observations. However, there are many other isotopes which are NMR observable and they include the common isotopes  $^{19}\text{F}$ ,  $^{31}\text{P}$  and  $^2\text{H}$ . The NMR spectroscopy of these "other nuclei" has had surprisingly little impact on the solution of structural problems in organic chemistry and will not be discussed here. It is however important to be alert for the presence of other magnetic nuclei in the molecule, because they often cause additional multiplicity in  $^1\text{H}$  and  $^{13}\text{C}$  NMR spectra due to spin-spin coupling.

## 7.6 SOLVENT INDUCED SHIFTS

Generally solvents chosen for NMR spectroscopy do not associate with the solute. However, solvents which are capable of both association and inducing differential chemical shifts in the solute are sometimes deliberately used to remove accidental chemical equivalence. The most useful solvents for the purpose of inducing *solvent-shifts* are aromatic solvents, in particular hexadeuterobenzene ( $\text{C}_6\text{D}_6$ ), and the effect is called *aromatic solvent induced shift* (ASIS). The numerical values of ASIS are usually of the order of 0.1 - 0.5 ppm and they vary with the molecule studied depending mainly on the geometry of the complexation.

## 8

## DETERMINING THE STRUCTURE OF ORGANIC COMPOUNDS FROM SPECTRA

---

The main purpose of this book is to present a collection of suitable problems to teach and train researchers in the general important methods of spectroscopy.

Problems 1 - 277 are all of the basic "structures from spectra" type, are generally relatively simple and are arranged roughly in order of increasing complexity. No solutions to the problems are given. It is important to assign NMR spectra as completely as possible and rationalise *all numbered peaks* in the mass spectrum and account for all significant features of the UV and IR spectra.

The next group of problems (278-283) present data in text form rather than graphically. The formal style that is found in the presentation of spectral data in these problems is typical of that found in the experimental of a publication or thesis. This is a completely different type of data presentation and one that students will encounter frequently. Problems 284 - 291 involve the quantitative analysis of mixtures using  $^1\text{H}$  and  $^{13}\text{C}$  NMR. These problems demonstrate the power of NMR in analysing samples that are not pure compounds and also develop skills in using spectral integration.

Problems 292 - 309 are a graded series of exercises in two-dimensional NMR (COSY, NOESY, C-H Correlation and TOCSY) ranging from very simple examples to demonstrate each of the techniques to complex examples where a combination of 2D methods is used to establish structure and distinguish between stereoisomers.

Problem 310 deals with molecular symmetry and is a useful exercise to establish how symmetry in a molecule can be established from the number of resonances in  $^1\text{H}$  and  $^{13}\text{C}$  NMR spectra. The last group of problems (311-332) are of a different type and deal with interpretation of simple  $^1\text{H}$  NMR spin-spin multiplets. To the best of our knowledge, problems of this type are not available in other collections and they are included here because we have found that the interpretation of multiplicity in  $^1\text{H}$  NMR spectra is the greatest single cause of confusion in the minds of students.

The spectra presented in the problems were obtained under conditions stated on the individual problem sheets. Mass spectra were obtained on an AEI MS-9 spectrometer or a Hewlett Packard MS-Engine mass spectrometer. 60 MHz  $^1\text{H}$  NMR spectra and

15 MHz  $^{13}\text{C}$  NMR spectra were obtained on a Jeol FX60Q spectrometer, 20 MHz  $^{13}\text{C}$  NMR spectra were obtained on a Varian CFT-20 spectrometer, 100 MHz  $^1\text{H}$  NMR spectra were obtained on a Varian XL-100 spectrometer, 200 MHz  $^1\text{H}$  NMR spectra and 50 MHz  $^{13}\text{C}$  NMR spectra were obtained on a Bruker AC-200 spectrometer, 400 MHz  $^1\text{H}$  NMR spectra and 100 MHz  $^{13}\text{C}$  NMR spectra were obtained on Bruker AMX-400 or DRX-400 spectrometers, and 500 and 600 MHz  $^1\text{H}$  NMR spectra were obtained on a Bruker DRX-500 or AMX-600 or DRX-600 spectrometers.

Ultraviolet spectra were recorded on a Perkin-Elmer 402 UV spectrophotometer or Hitachi 150-20 UV spectrophotometer and Infrared spectra on a Perkin-Elmer 710B or a Perkin-Elmer 1600 series FTIR spectrometer.

The following collections are useful sources of spectroscopic data on organic compounds and some of the data for literature compounds have been derived from these collections:

- (a) [http://riodb01.ibase.aist.go.jp/sdbs/cgi-bin/cre\\_index.cgi?lang=eng](http://riodb01.ibase.aist.go.jp/sdbs/cgi-bin/cre_index.cgi?lang=eng) website maintained by the National Institute of Advanced Industrial Science and Technology, Tsukuba, Ibaraki, Japan;
- (b) <http://webbook.nist.gov/chemistry/> website which is the NIST Chemistry WebBook, NIST Standard Reference Database Number 69, June 2005, Eds. P.J. Linstrom and W.G. Mallard.
- (c) E Pretch, P Bühlmann and C Affolter, "Structure Determination of Organic Compounds, Tables of Spectral Data", 3<sup>rd</sup> edition, Springer, Berlin 2000.

While there is no doubt in our minds that the only way to acquire expertise in obtaining "organic structures from spectra" is to practise, some students have found the following **general approach to solving structural problems by a combination of spectroscopic methods** helpful:

- (1) Perform all **routine operations**:
  - (a) Determine the molecular weight from the Mass Spectrum.
  - (b) Determine relative numbers of protons in different environments from the  $^1\text{H}$  NMR spectrum.
  - (c) Determine the number of carbons in different environments and the number of quaternary carbons, methine carbons, methylene carbons and methyl carbons from the  $^{13}\text{C}$  NMR spectrum.



- (d) Examine the problem for any additional data concerning composition and determine the molecular formula if possible. From the molecular formula, determine the degree of unsaturation.
- (e) Determine the molar absorbance in the UV spectrum, if applicable.
- (2) Examine each spectrum (IR, mass spectrum, UV,  $^{13}\text{C}$  NMR,  $^1\text{H}$  NMR) in turn for obvious **structural elements**:
- (a) Examine the IR spectrum for the presence or absence of groups with diagnostic absorption bands *e.g.* carbonyl groups, hydroxyl groups, NH groups,  $\text{C}\equiv\text{C}$  or  $\text{C}\equiv\text{N}$ , *etc.*
- (b) Examine the mass spectrum for typical fragments *e.g.*  $\text{PhCH}_2^-$ ,  $\text{CH}_3\text{CO}^-$ ,  $\text{CH}_3^-$ , *etc.*
- (c) Examine the UV spectrum for evidence of conjugation, aromatic rings *etc.*
- (d) Examine the  $^1\text{H}$  NMR spectrum for  $\text{CH}_3^-$  groups,  $\text{CH}_3\text{CH}_2^-$  groups, aromatic protons,  $-\text{CH}_n\text{X}$ , exchangeable protons *etc.*
- (3) Write down all structural elements you have determined. Note that some are monofunctional (*i.e.* must be end-groups, such as  $-\text{CH}_3$ ,  $-\text{C}\equiv\text{N}$ ,  $-\text{NO}_2$ ) whereas some are bifunctional (*e.g.*  $-\text{CO}-$ ,  $-\text{CH}_2^-$ ,  $-\text{COO}-$ ), or trifunctional (*e.g.*  $\text{CH}$ ,  $\text{N}$ ).
- Add up the atoms of each structural element and compare the total with the molecular formula of the unknown. The difference (if any) may give a clue to the nature of the undetermined structural elements (*e.g.* an ether oxygen). At this stage, elements of symmetry may become apparent.
- (4) Try to assemble the structural elements. Note that **there may be more than one way of fitting them together**. Spin-spin coupling data or information about conjugation may enable you to make a definite choice between possibilities.
- (5) Return to each spectrum (IR, UV, mass spectrum,  $^{13}\text{C}$  NMR,  $^1\text{H}$  NMR) in turn and *rationalise all major features* (especially all major fragments in the mass spectrum and all features of the NMR spectra) in terms of your proposed structure. Ensure that no spectral features are inconsistent with your proposed structure.

**Note on the use of data tables.** Tabulated data typically give characteristic absorptions or chemical shifts for representative compounds and these may not correlate *exactly* with those from an unknown compound. The data contained in data tables should always be used indicatively (not mechanically).

# 9

## PROBLEMS

### 9.1

## SPECTROSCOPIC IDENTIFICATION OF ORGANIC COMPOUNDS

---

## Problem 1

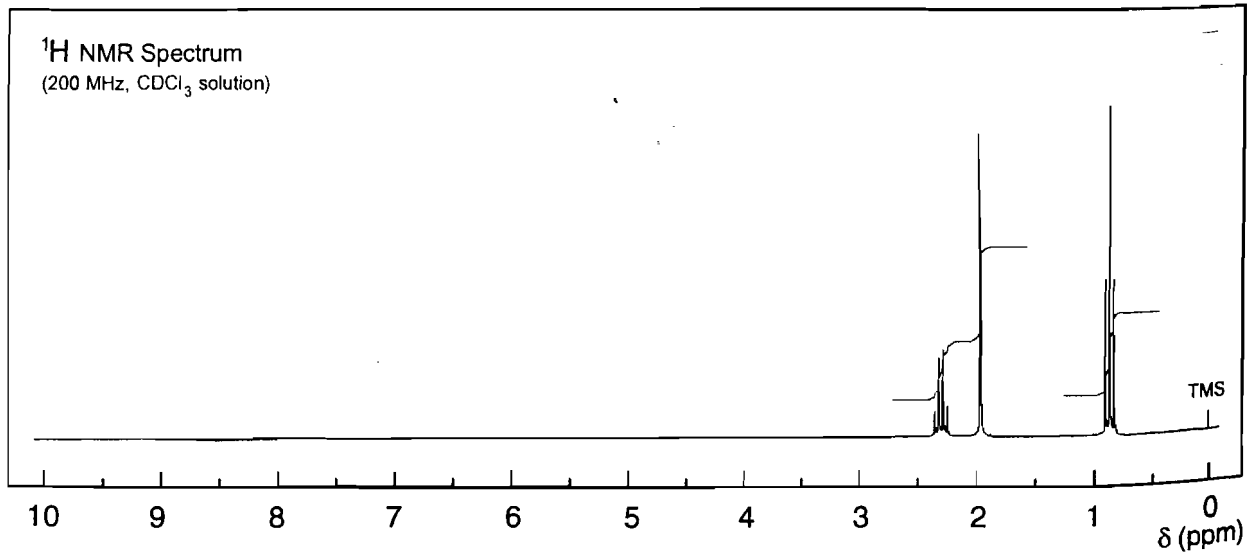
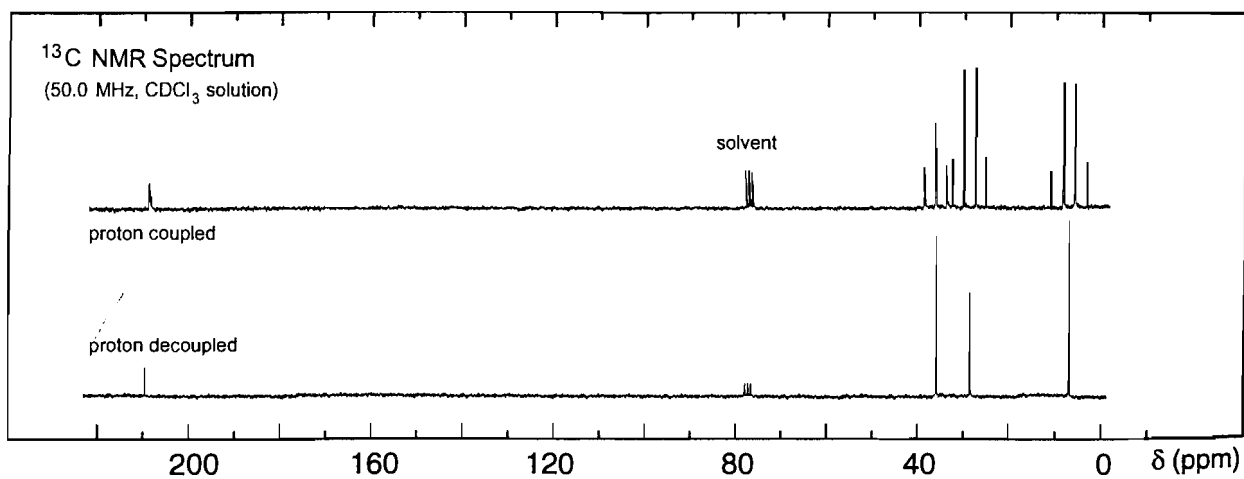
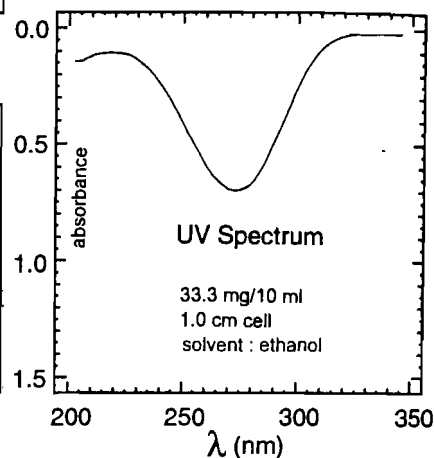
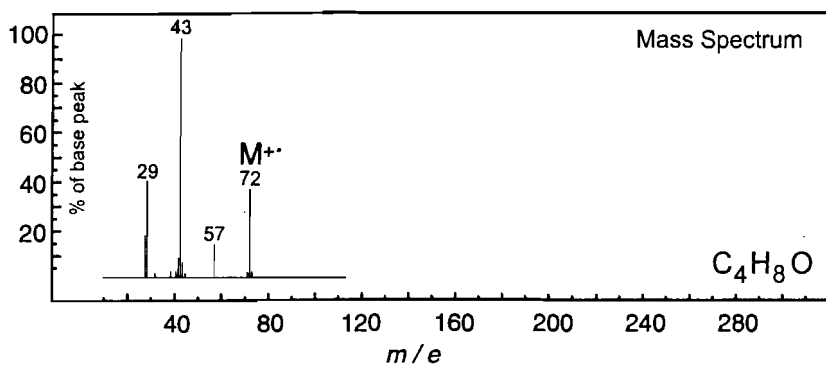
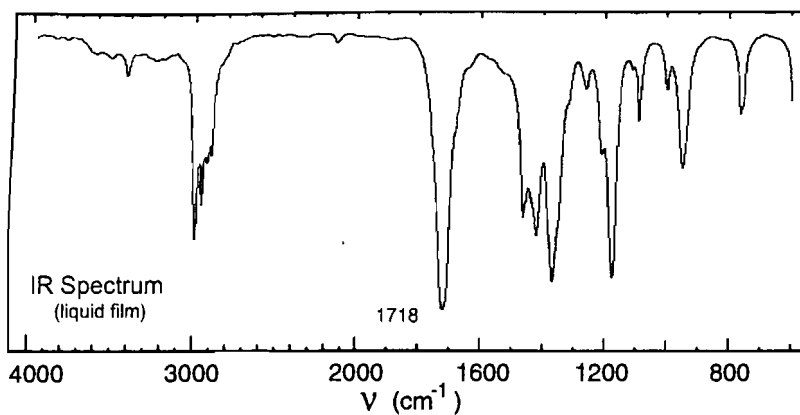

# Problem 2

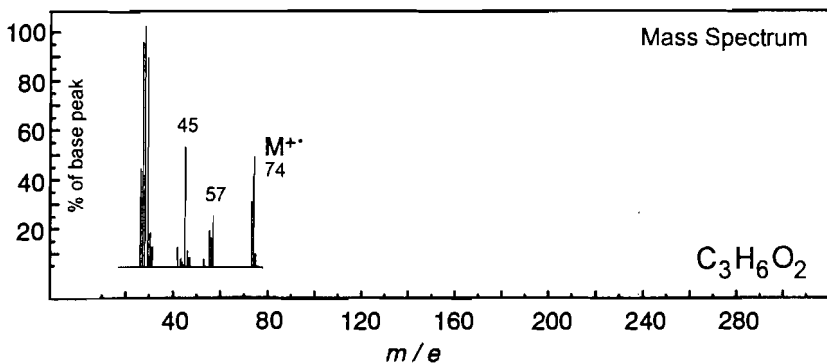
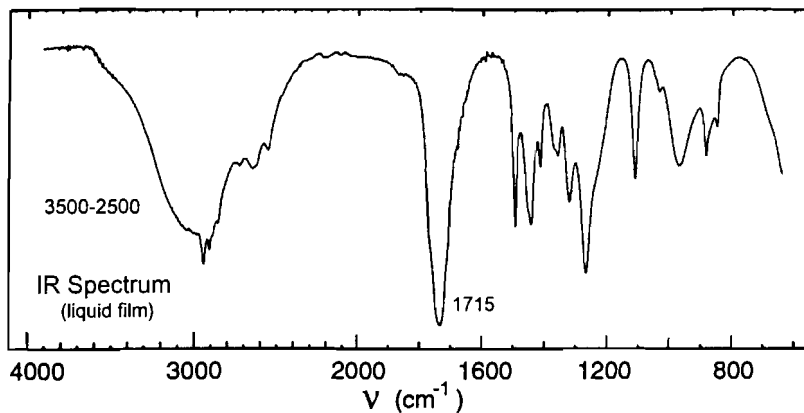

No significant UV absorption above 220 nm

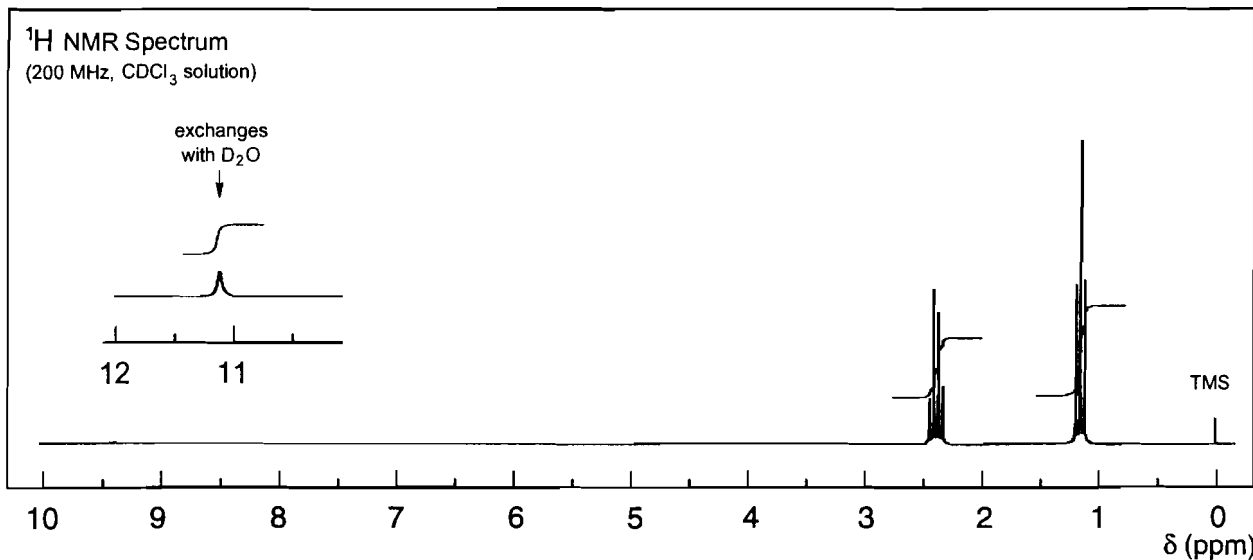
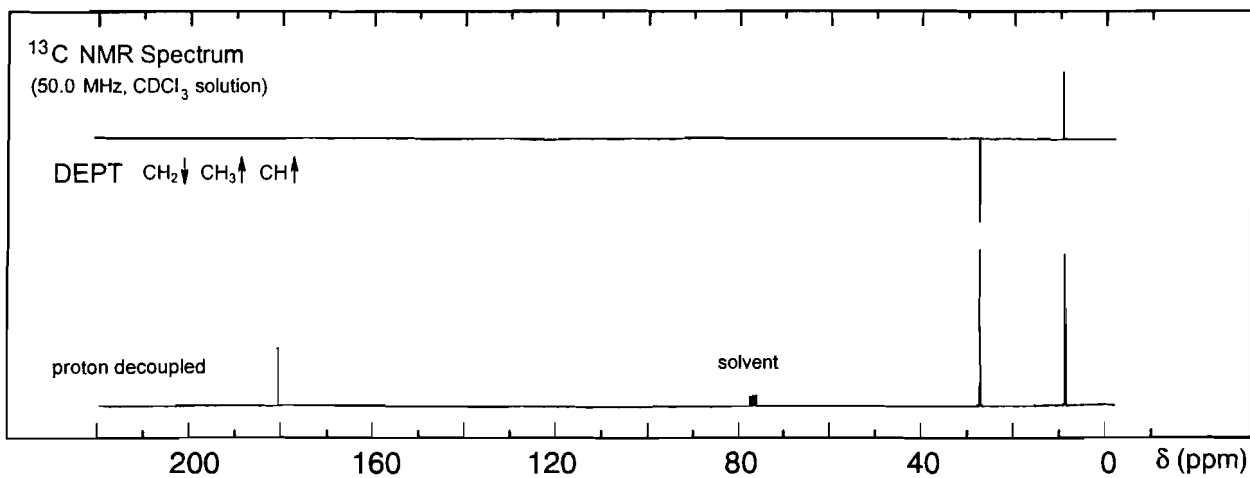

# Problem 3

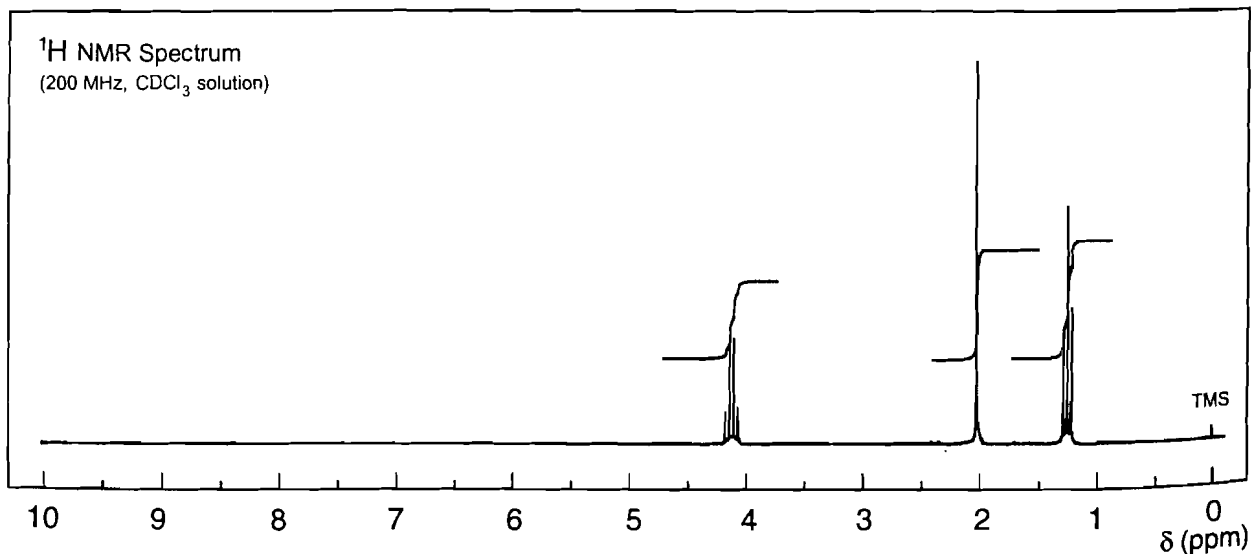
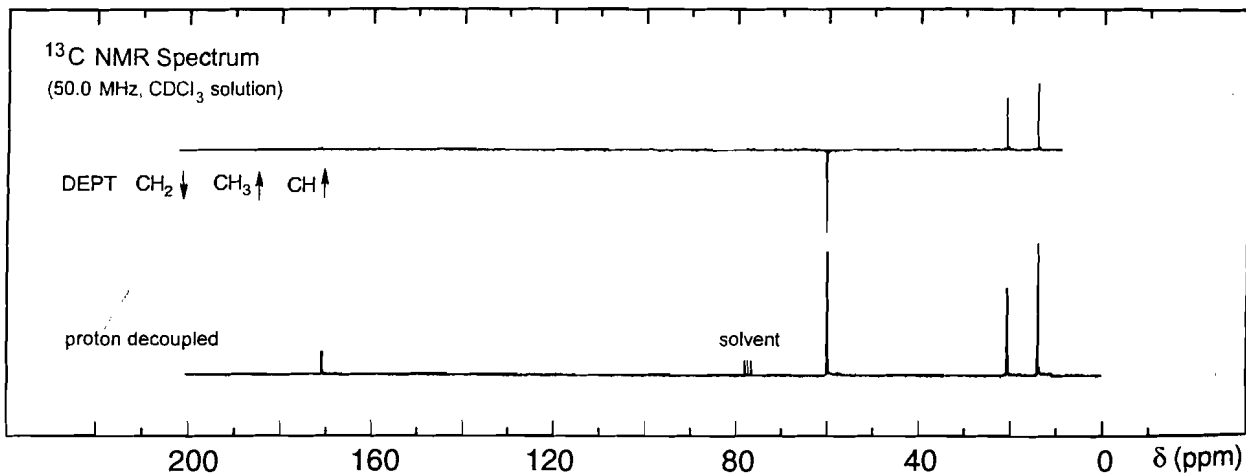
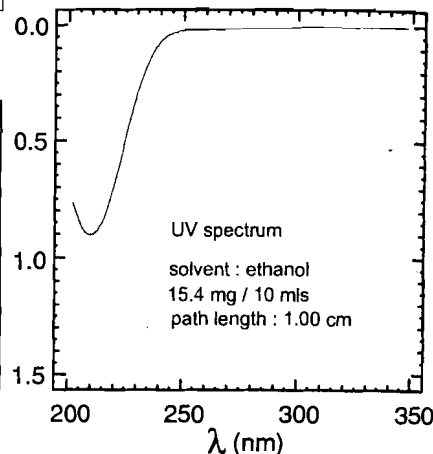
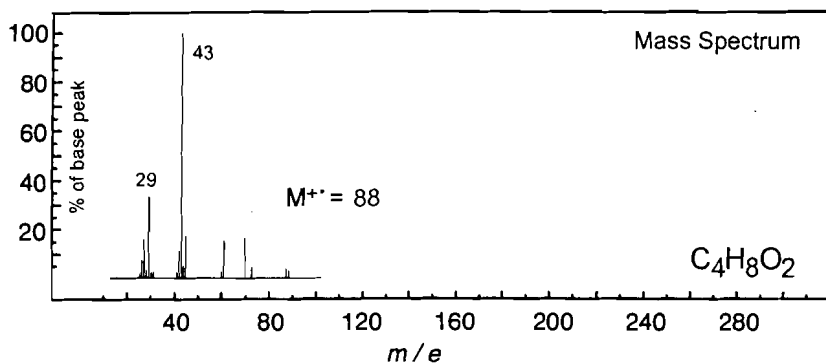
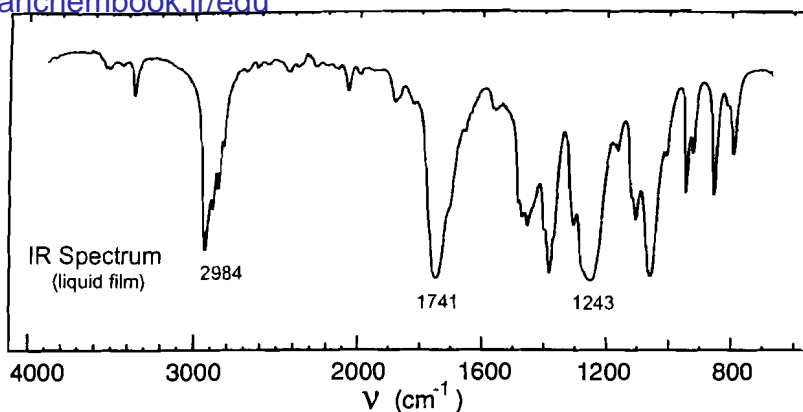

# Problem 4

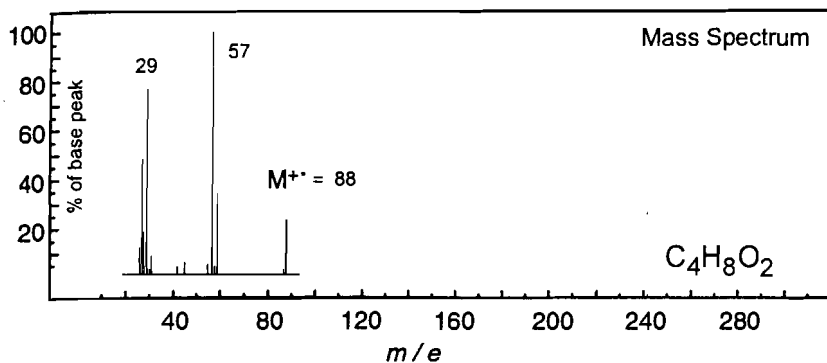
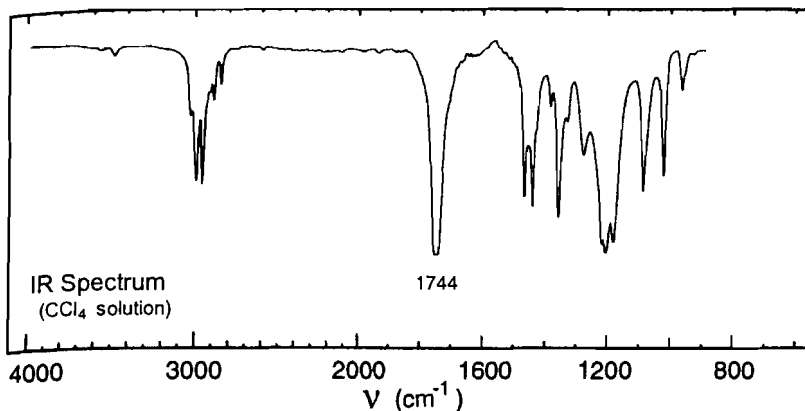

No significant UV  
absorption above 220 nm

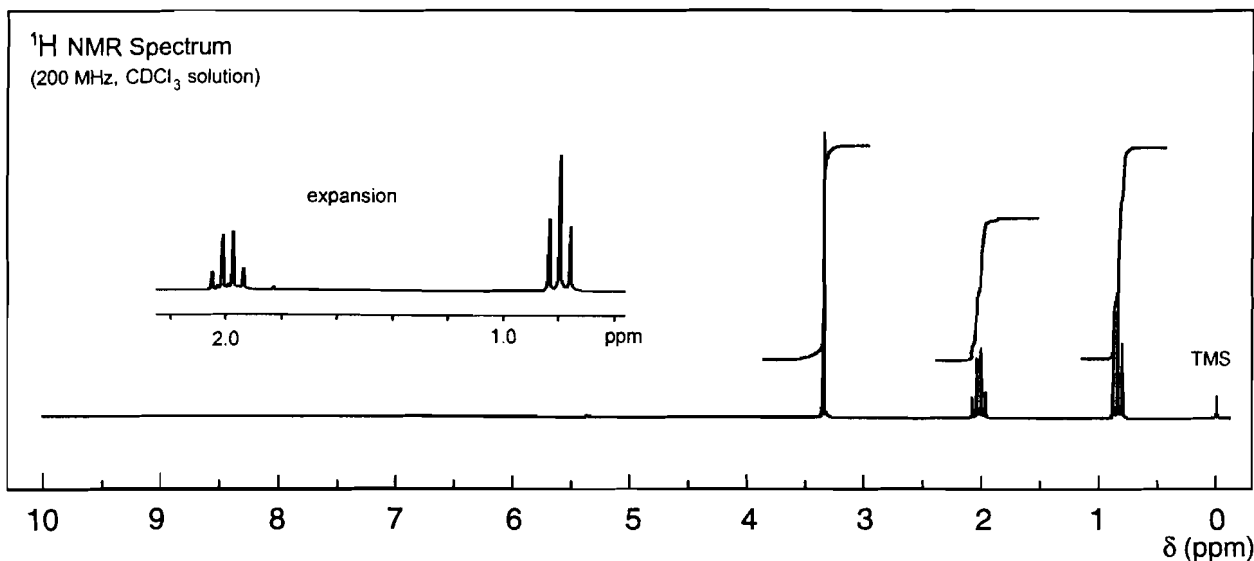
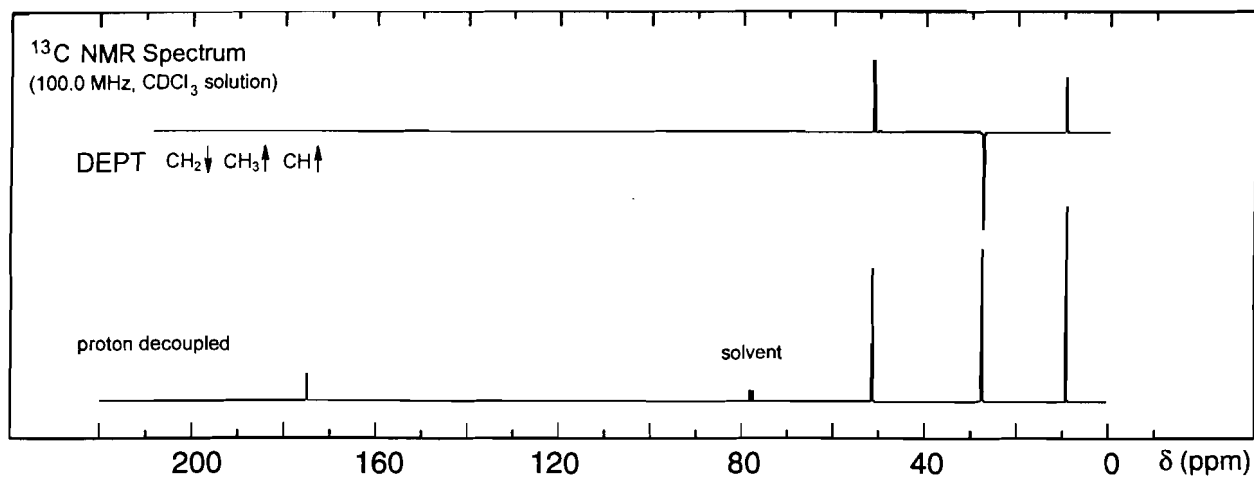

## Problem 5

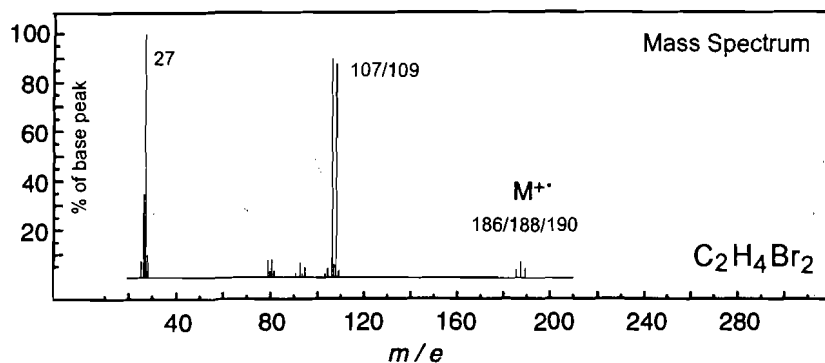
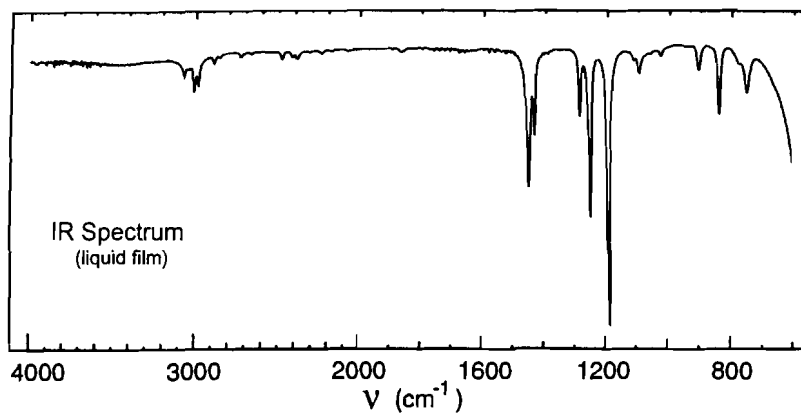

No significant UV  
absorption above 220 nm

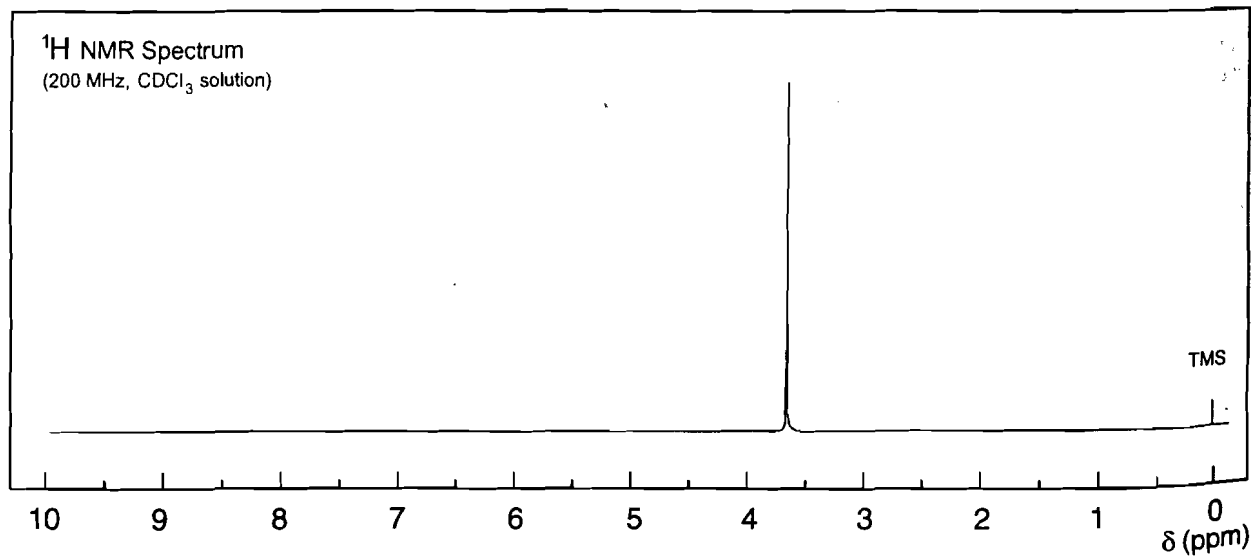
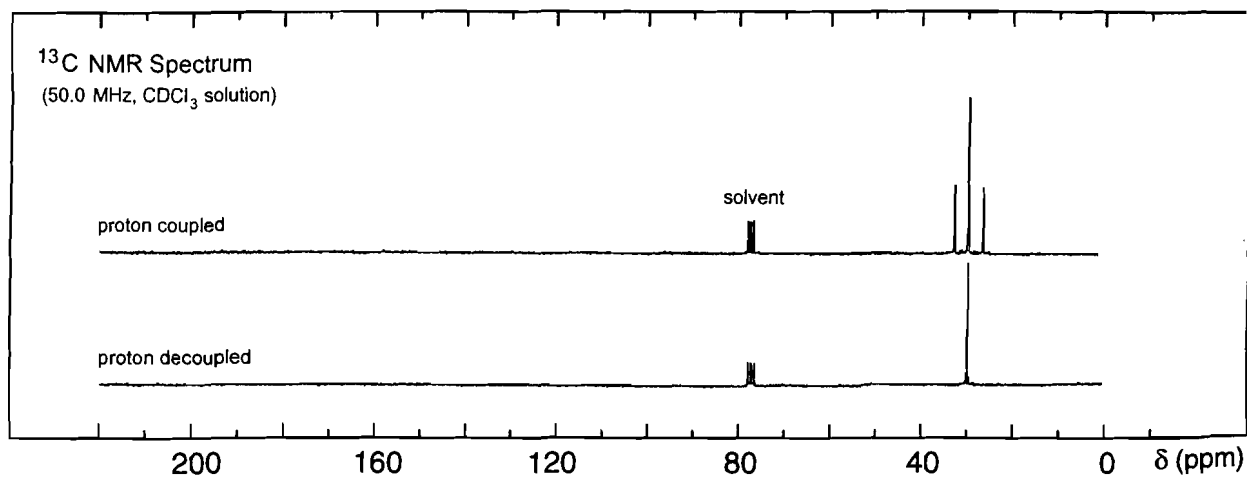

# Problem 6

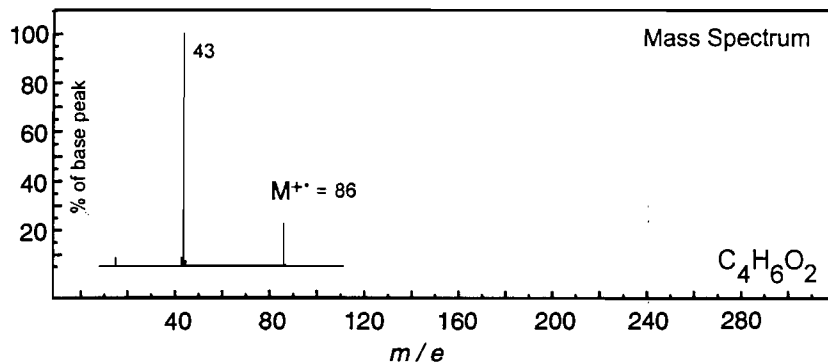
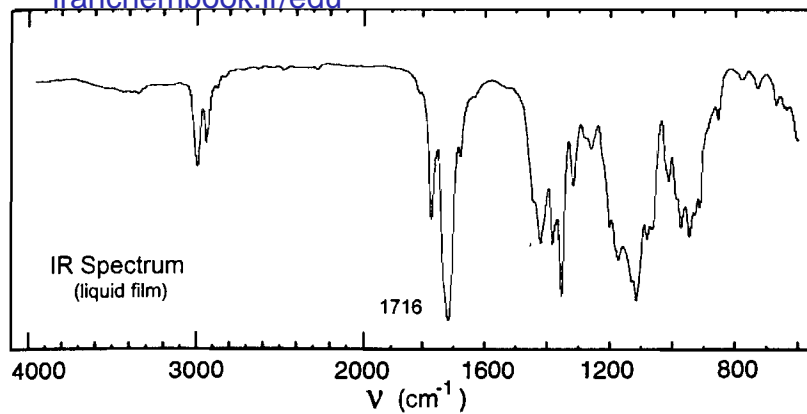

UV Spectrum

$\lambda_{\text{max}}$  289 nm ( $\log_{10} \epsilon$  1.4)

solvent: methanol

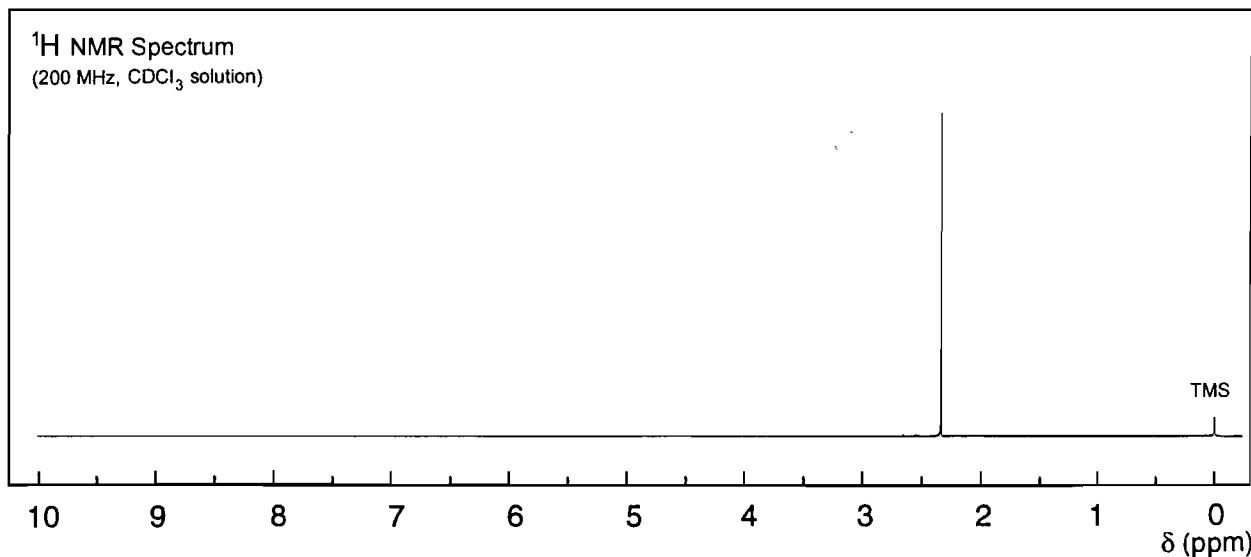
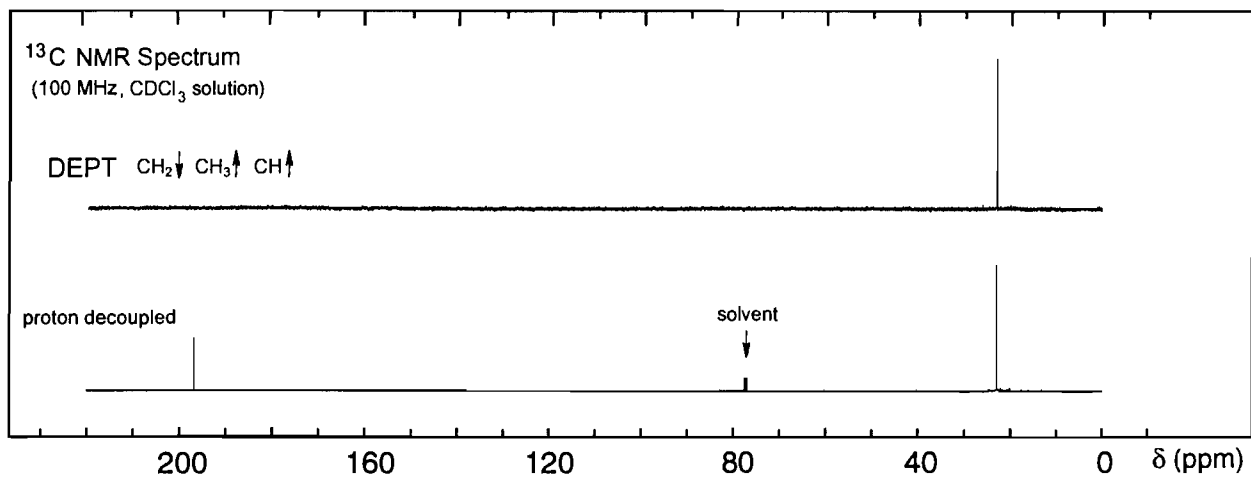



## Problem 7

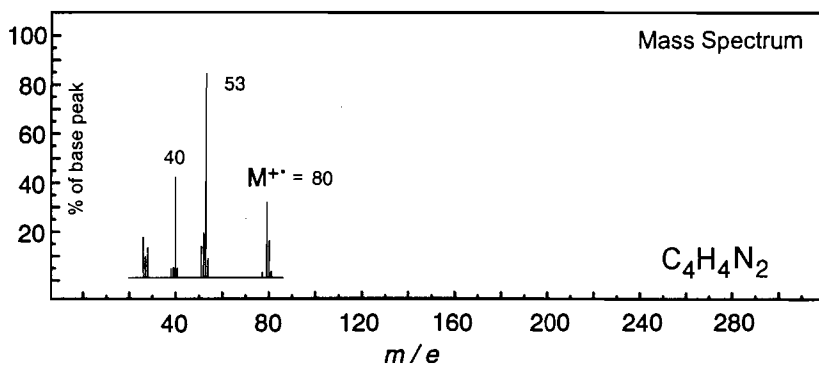
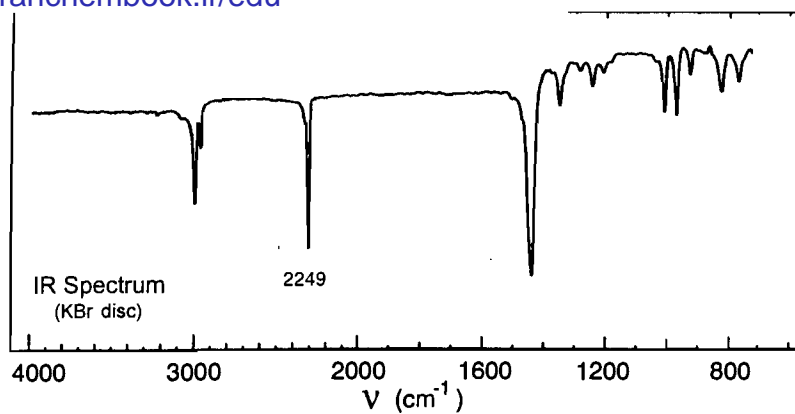

No significant UV  
absorption above 220 nm

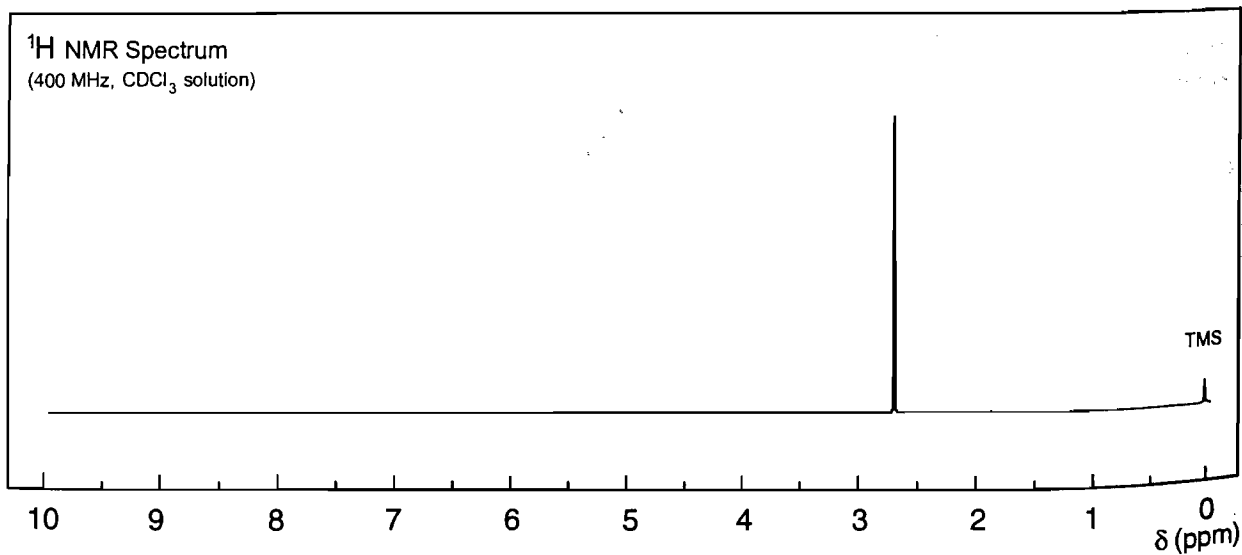
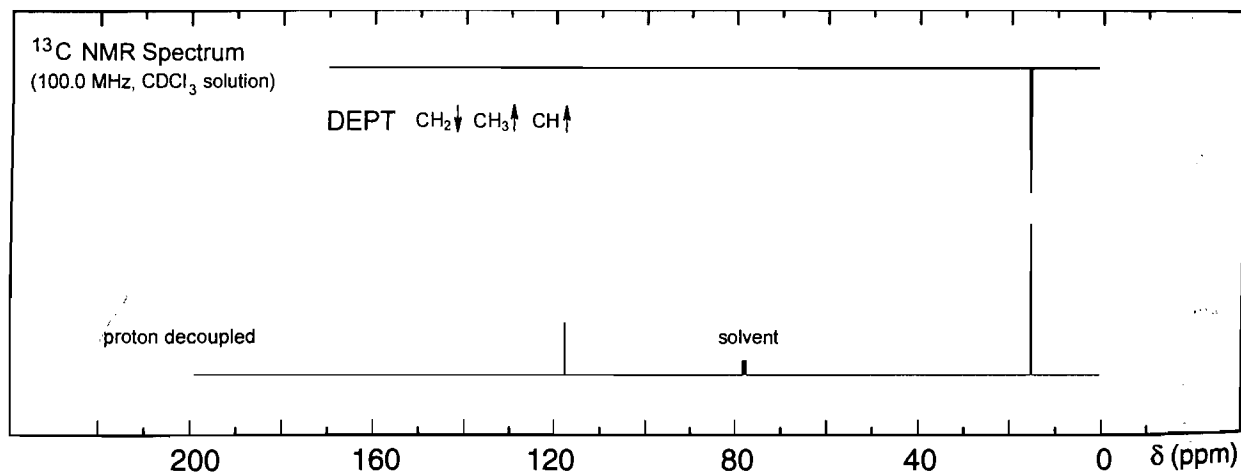

# Problem 8

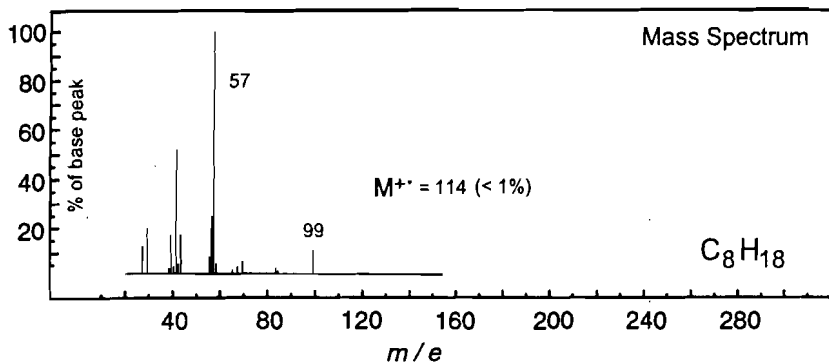
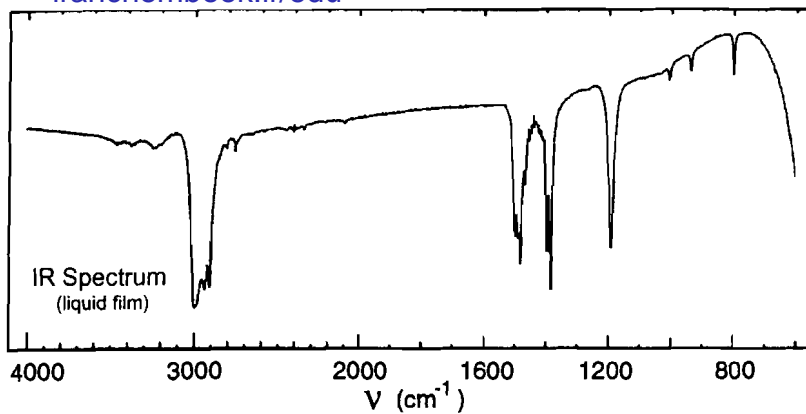

No significant UV  
absorption above 220 nm

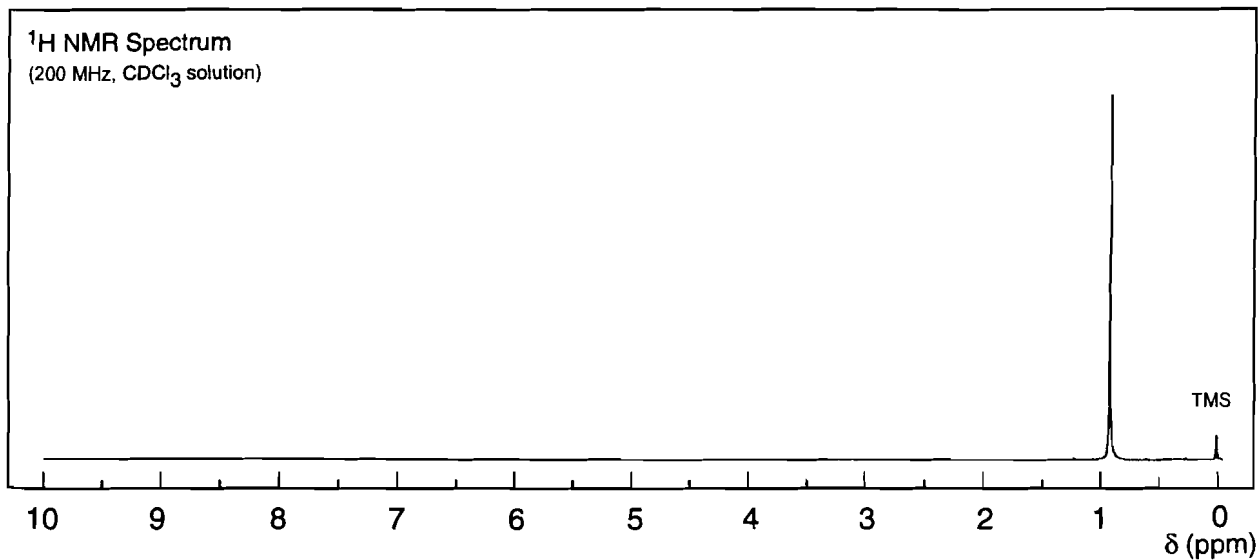
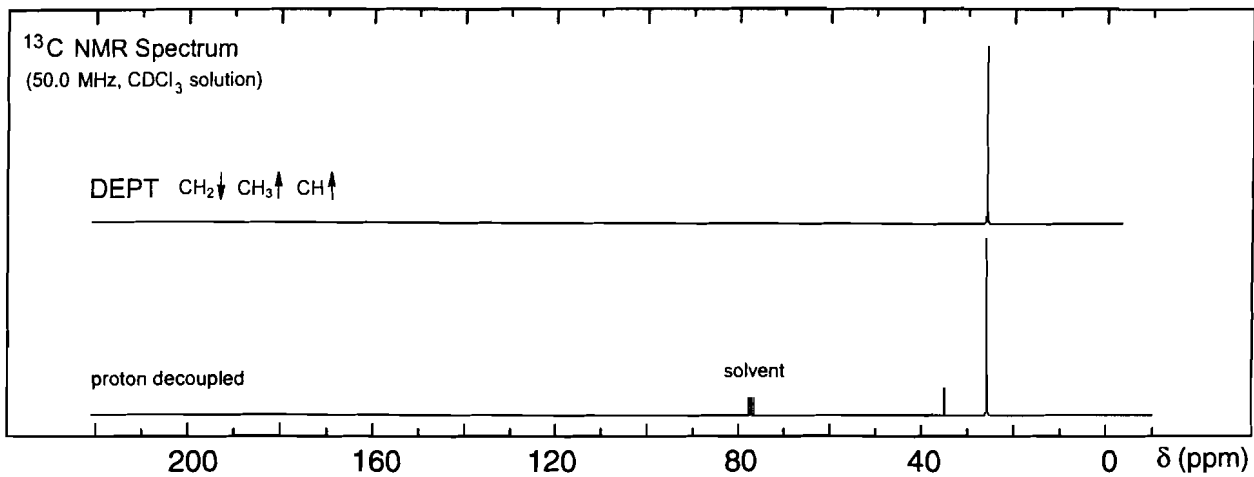

## Problem 9

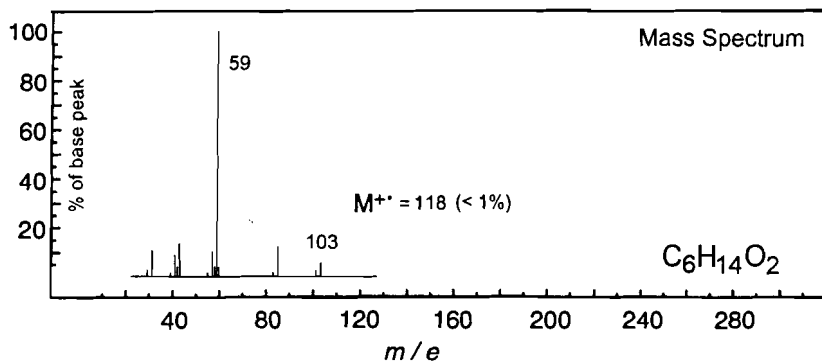
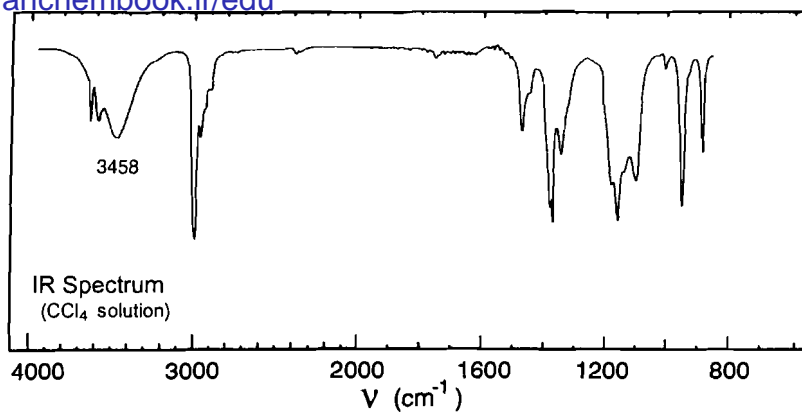

No significant UV  
absorption above 220 nm

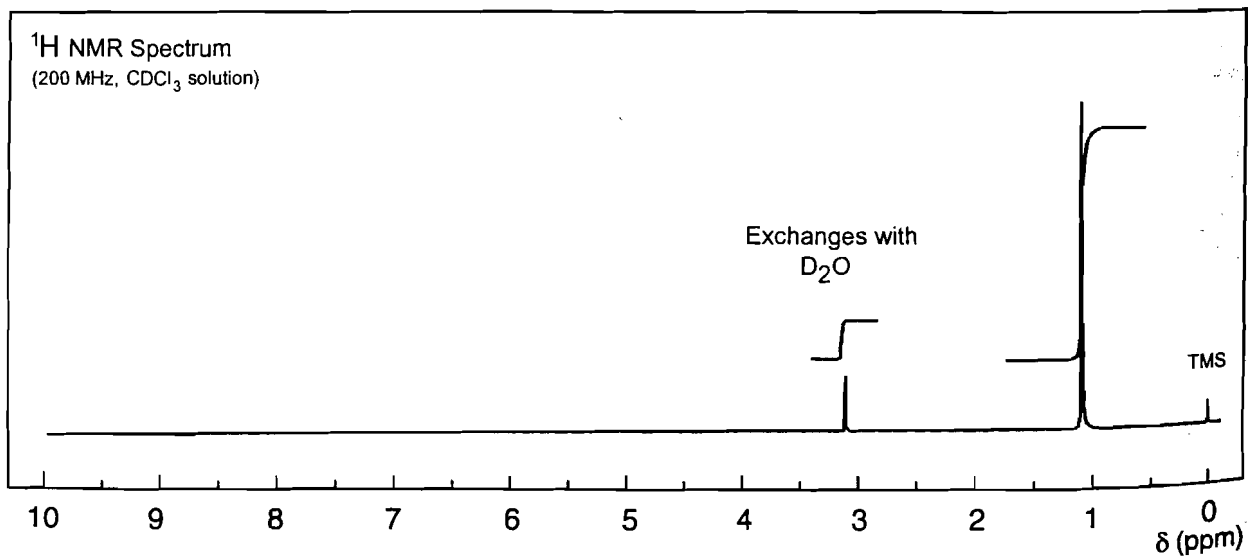
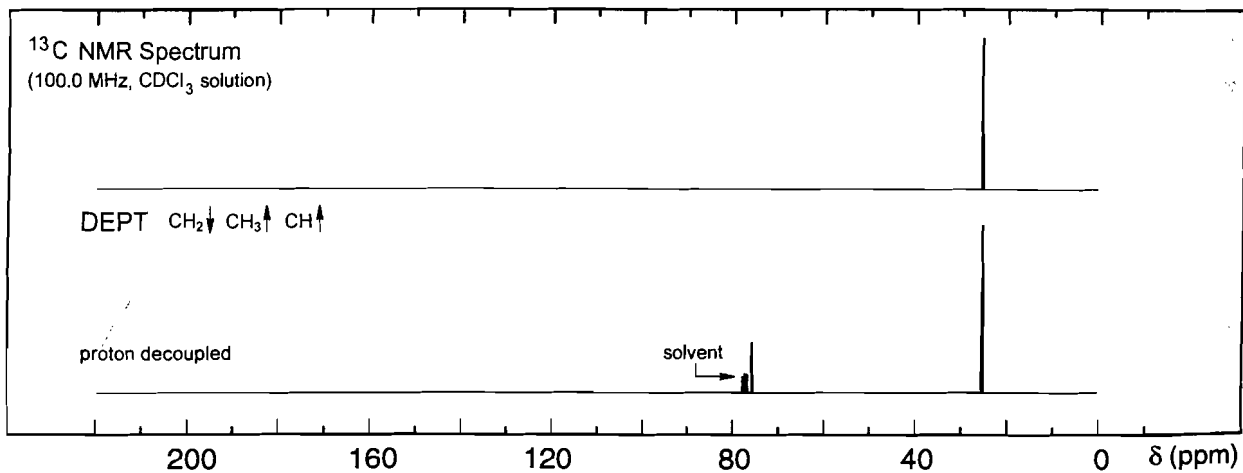

# Problem 10

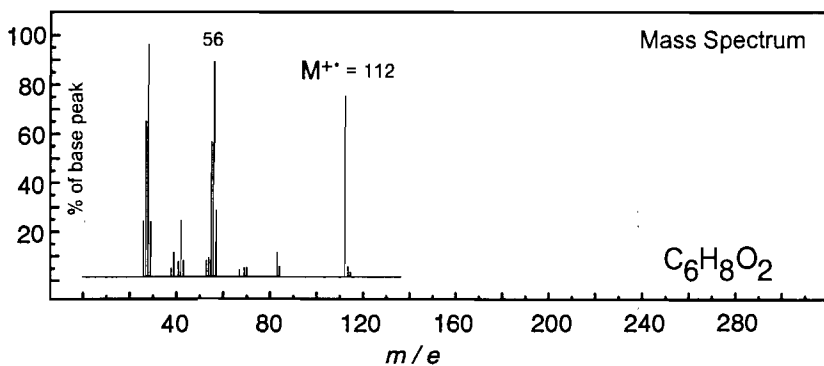
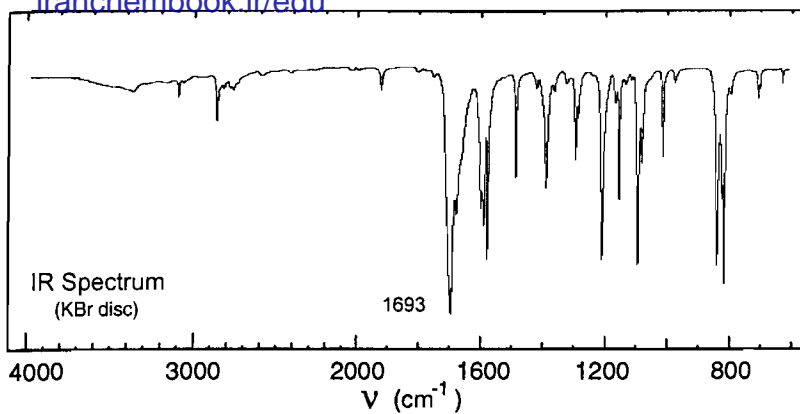

No significant UV absorption above 220 nm

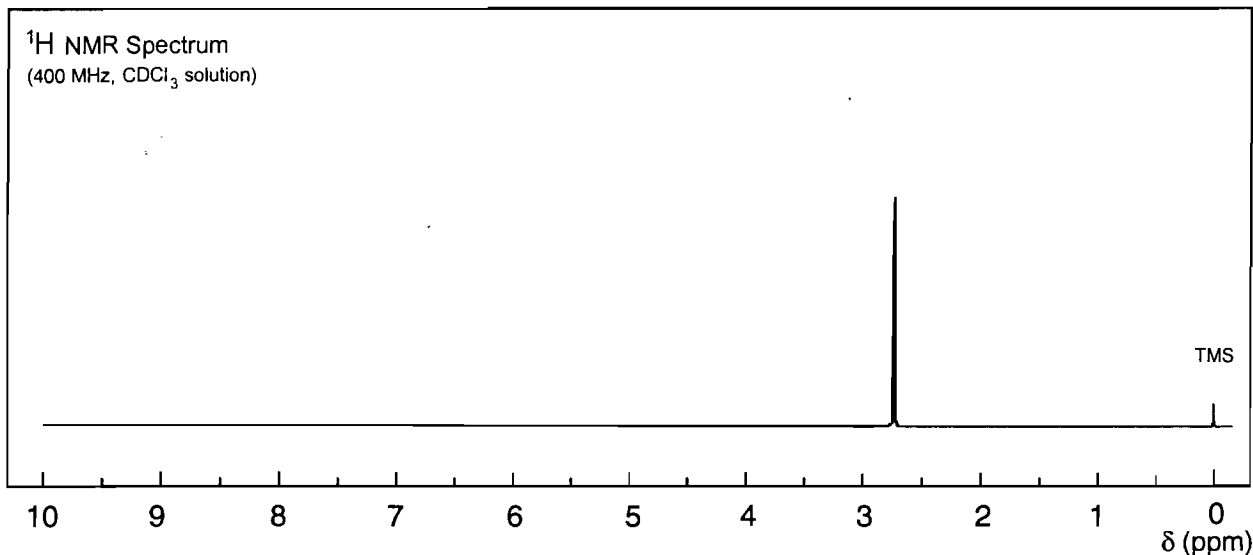
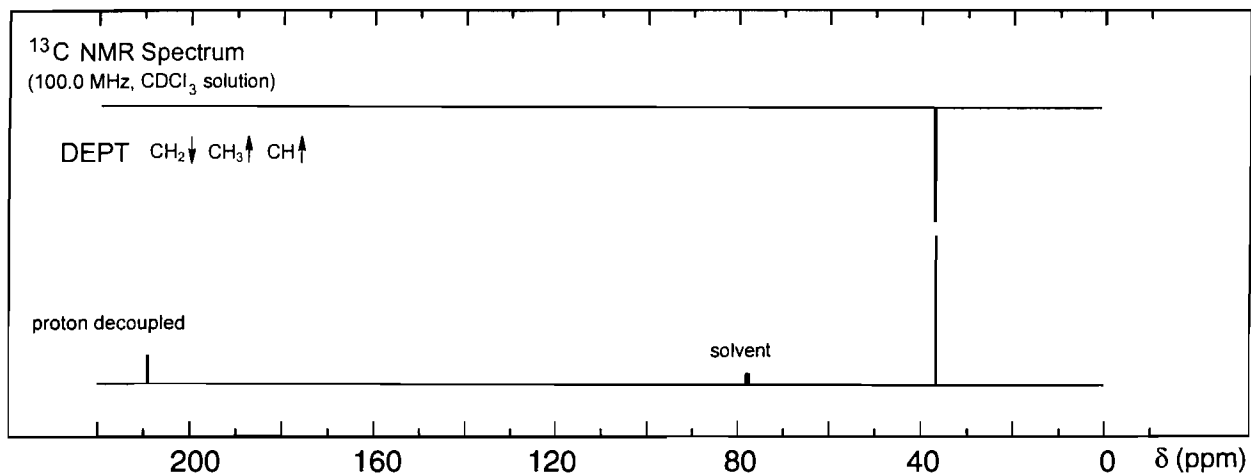

## Problem 11

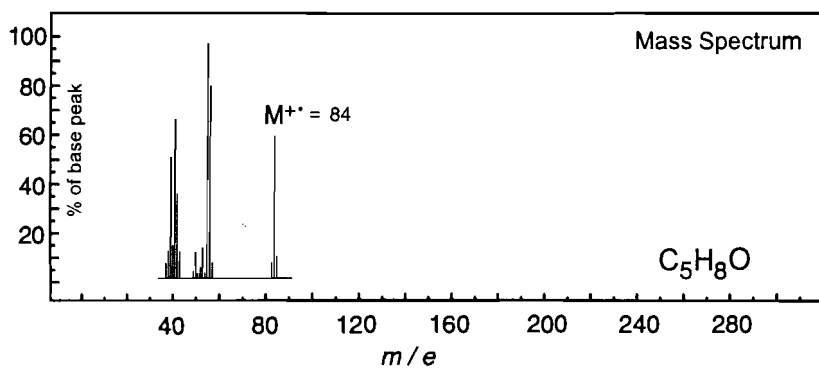
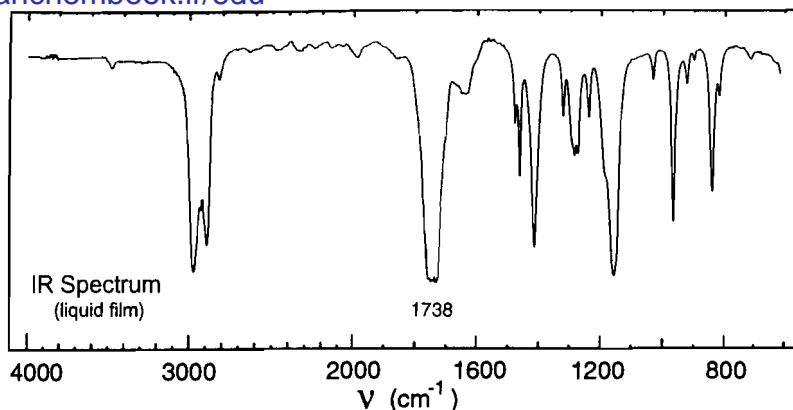

No significant UV  
absorption above 220 nm

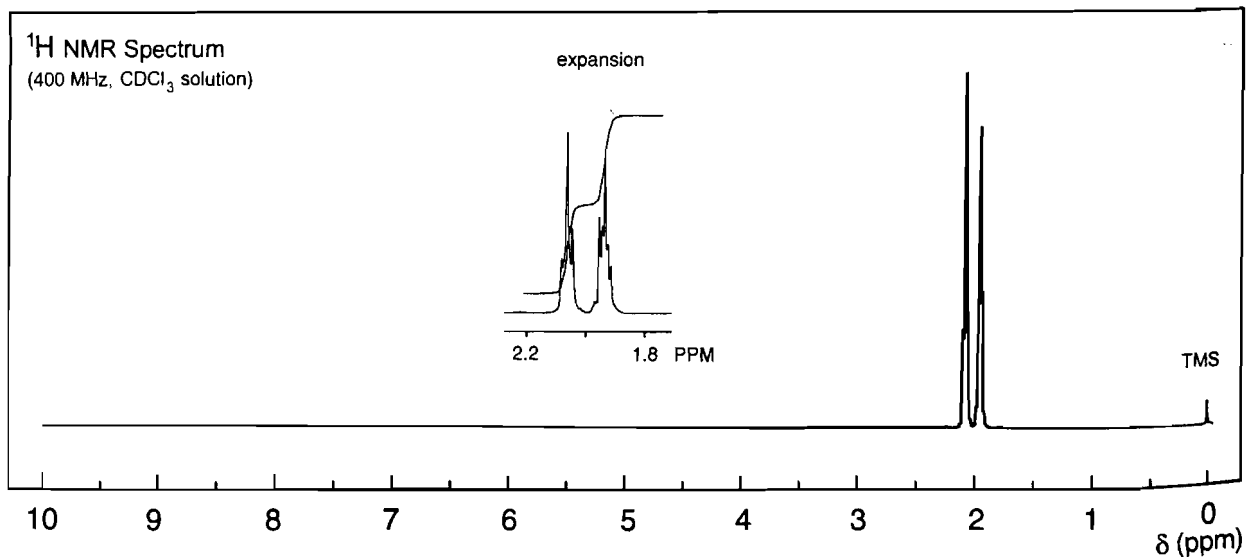
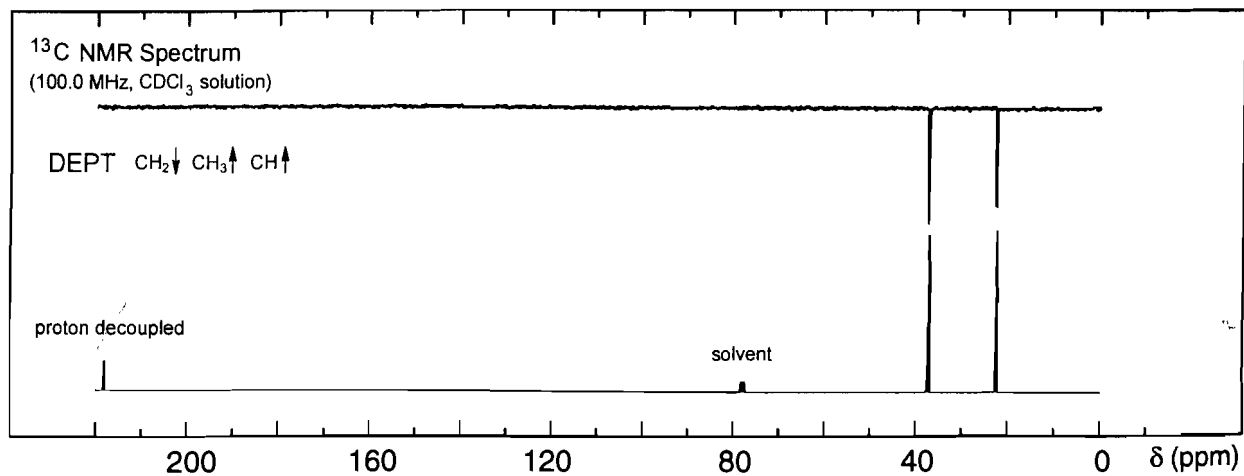

## Problem 12

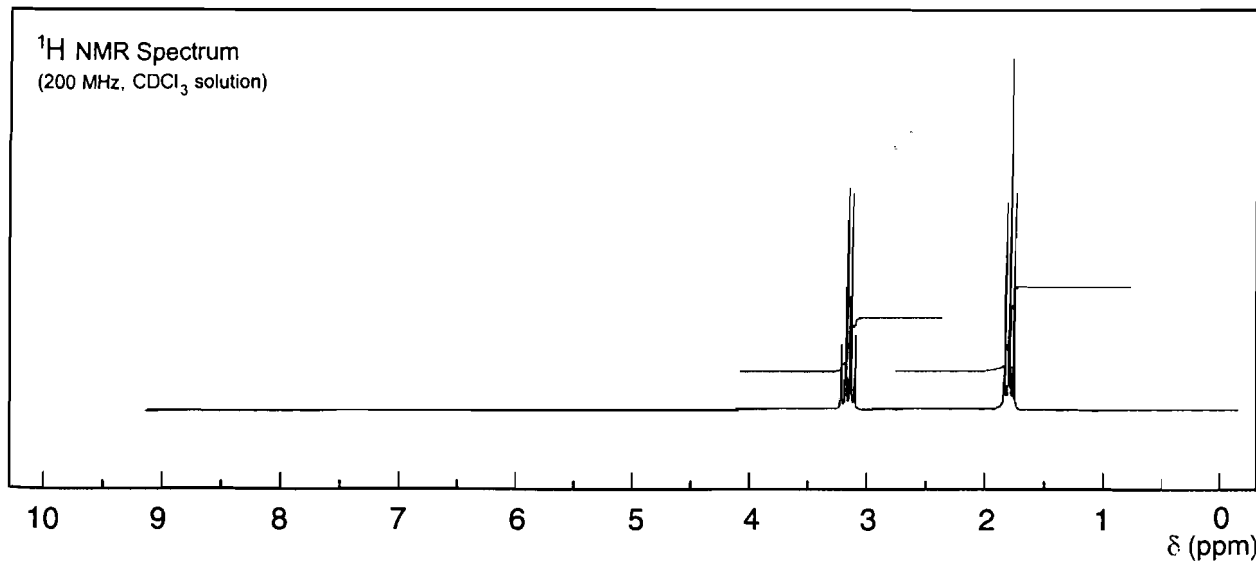
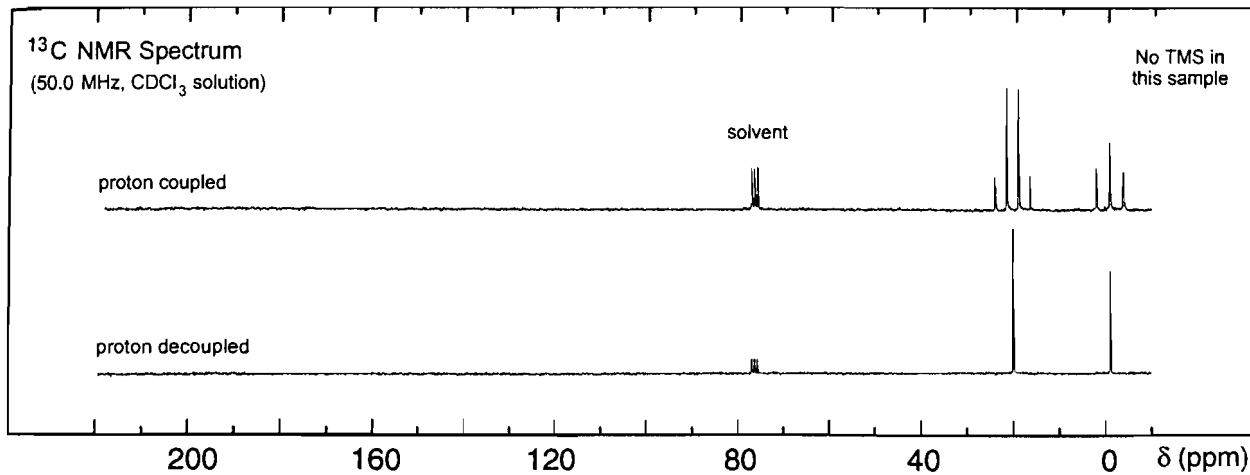
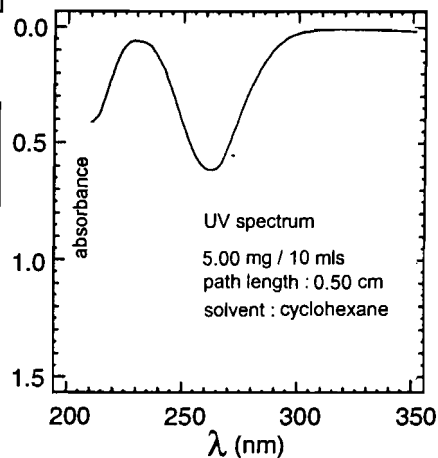
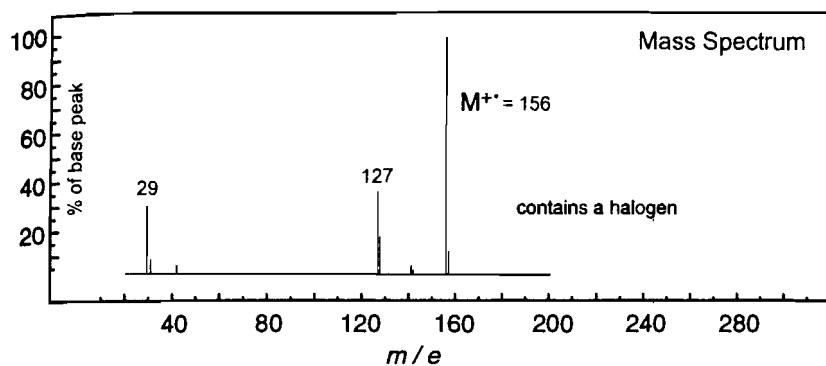
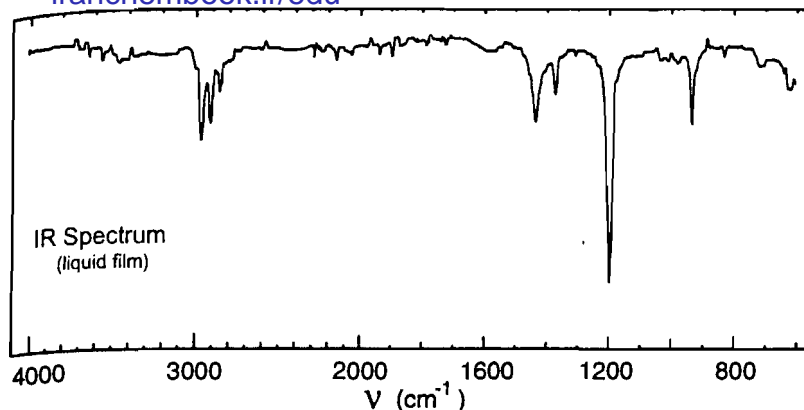

## Problem 13

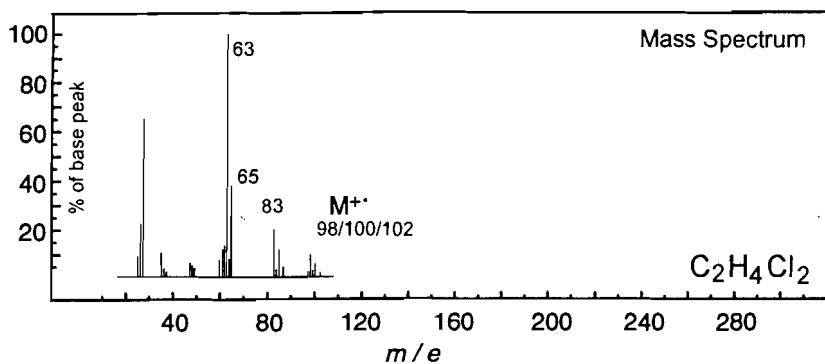
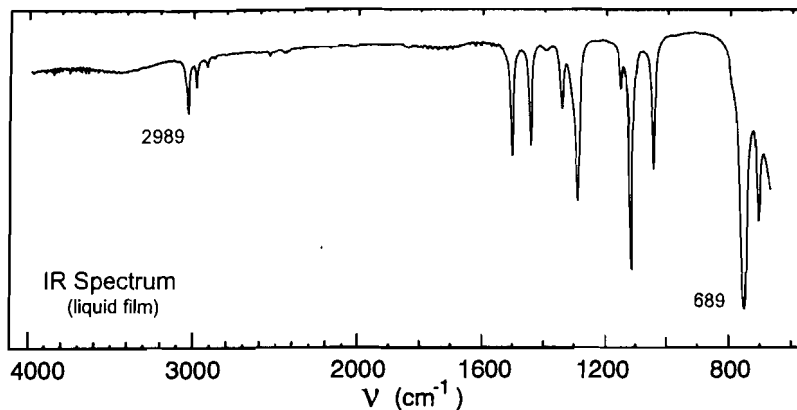

No significant UV  
absorption above 220 nm

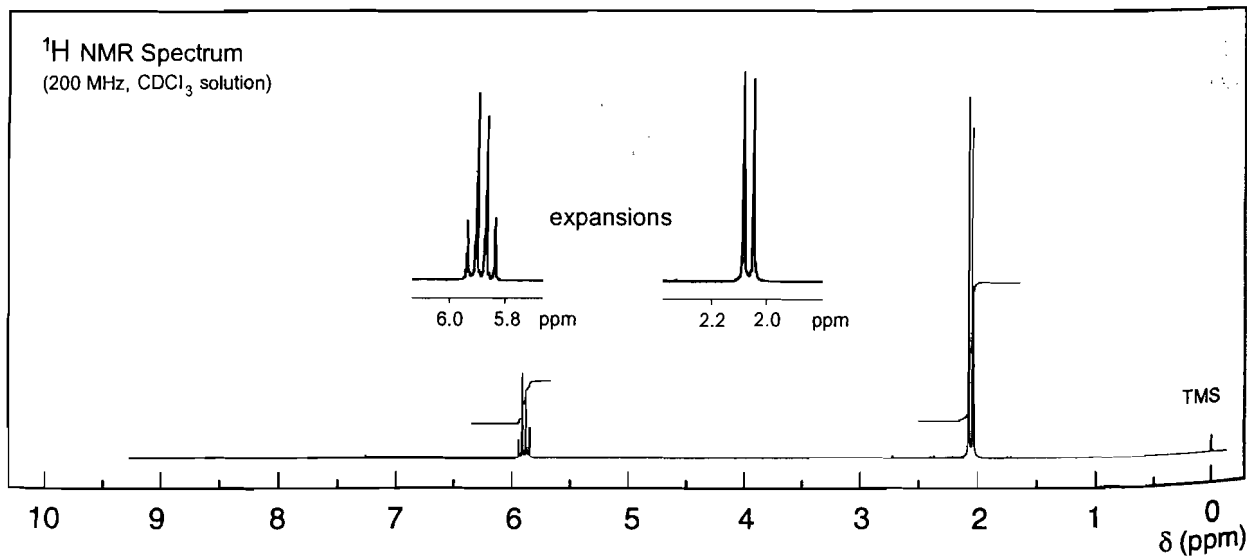
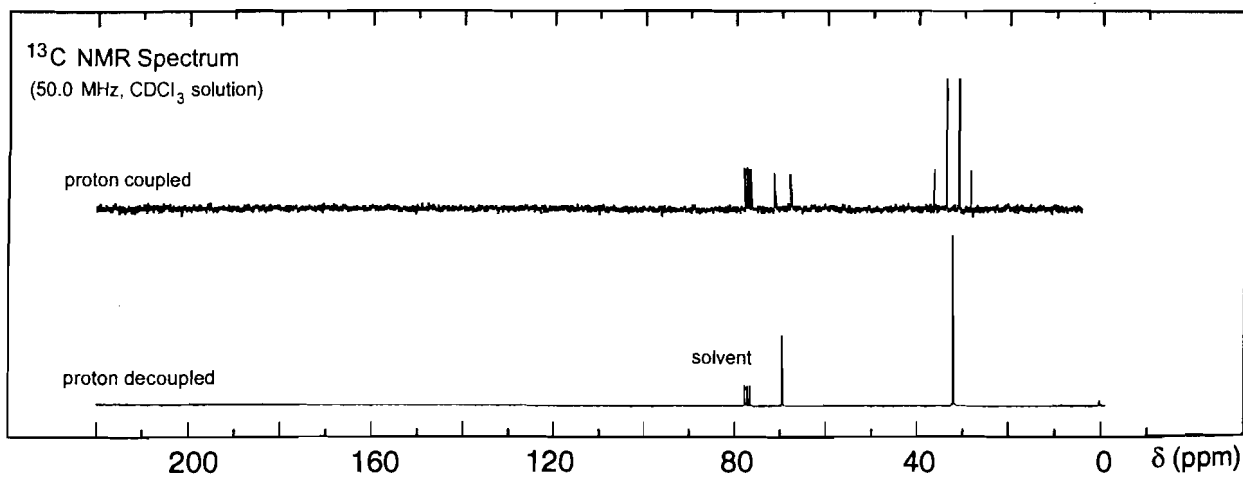

## Problem 14

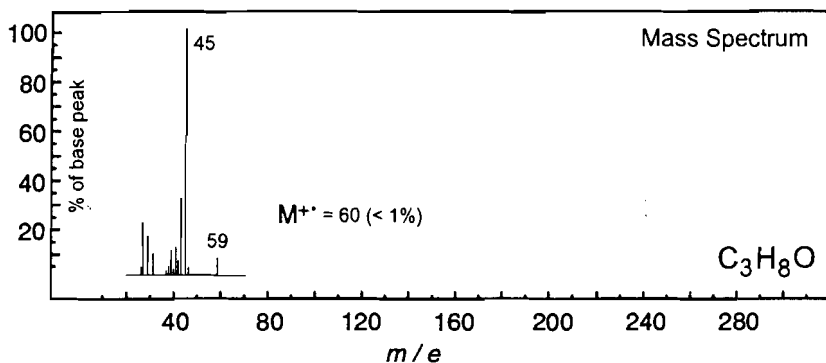
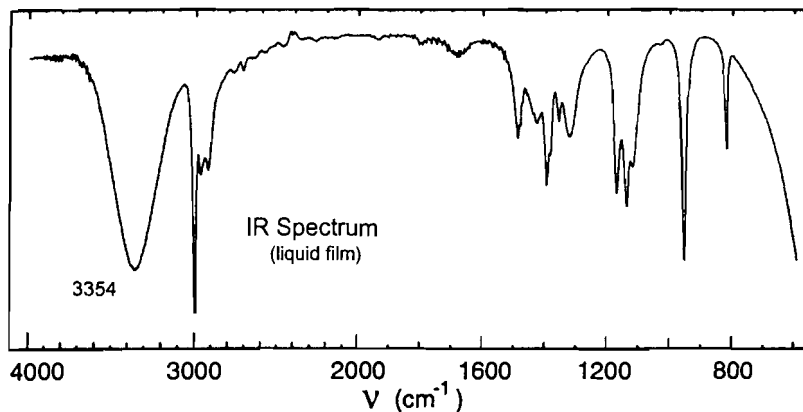

No significant UV  
absorption above 220 nm

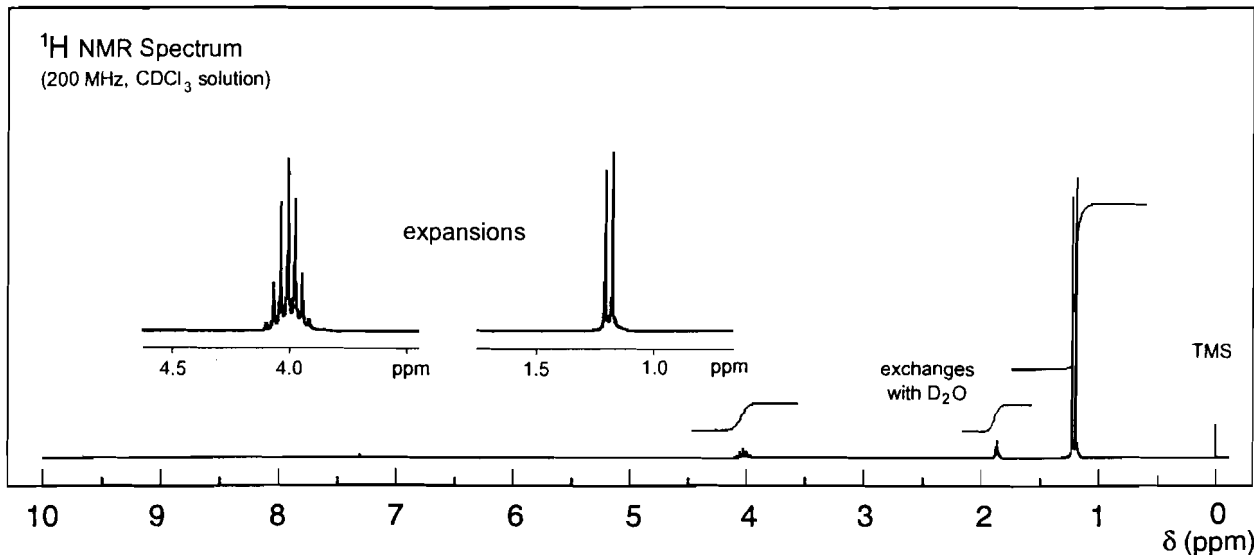
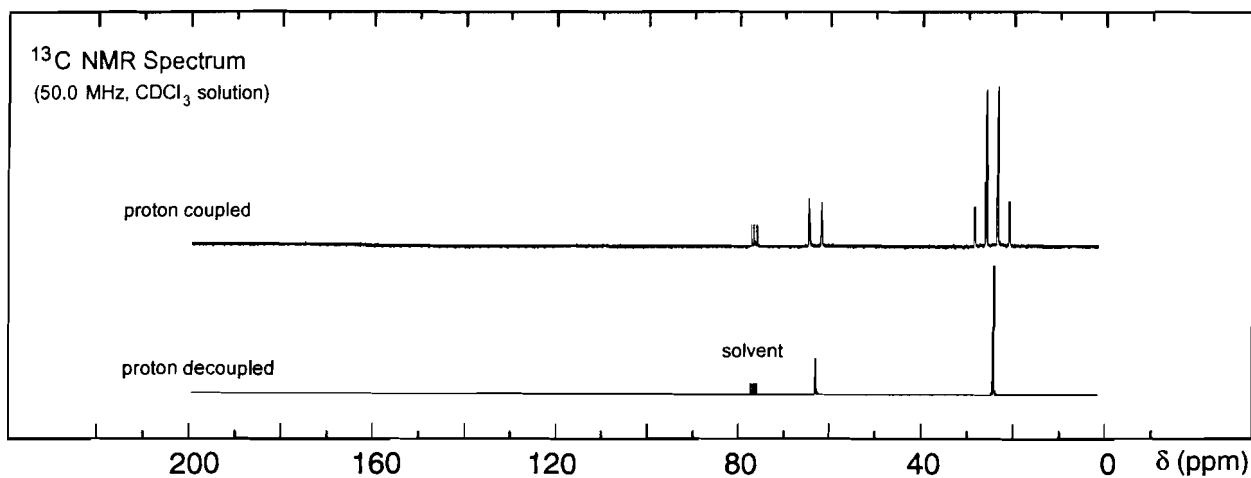



## Problem 15

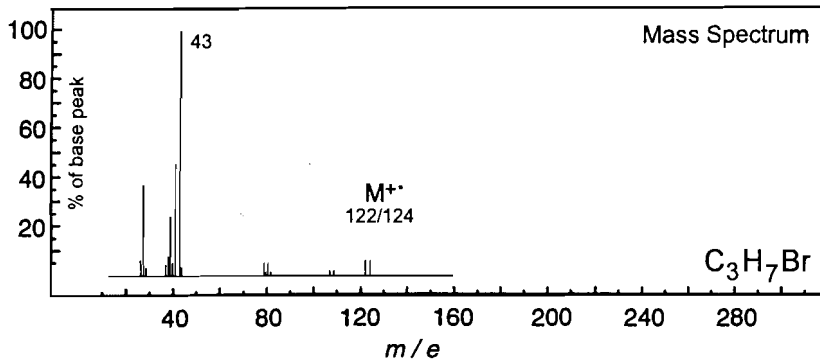
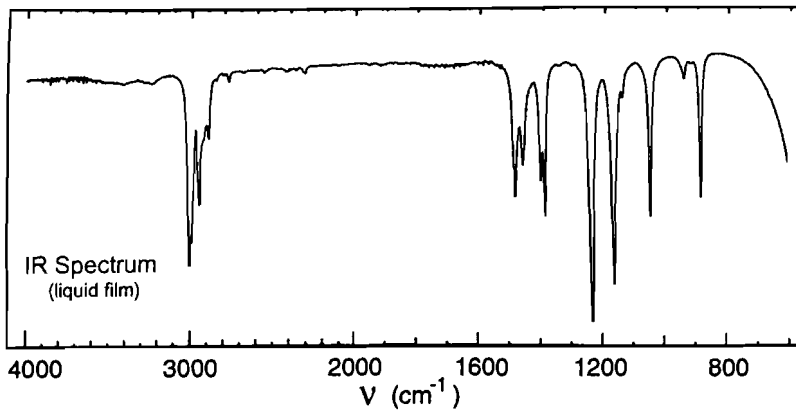

No significant UV  
absorption above 220 nm

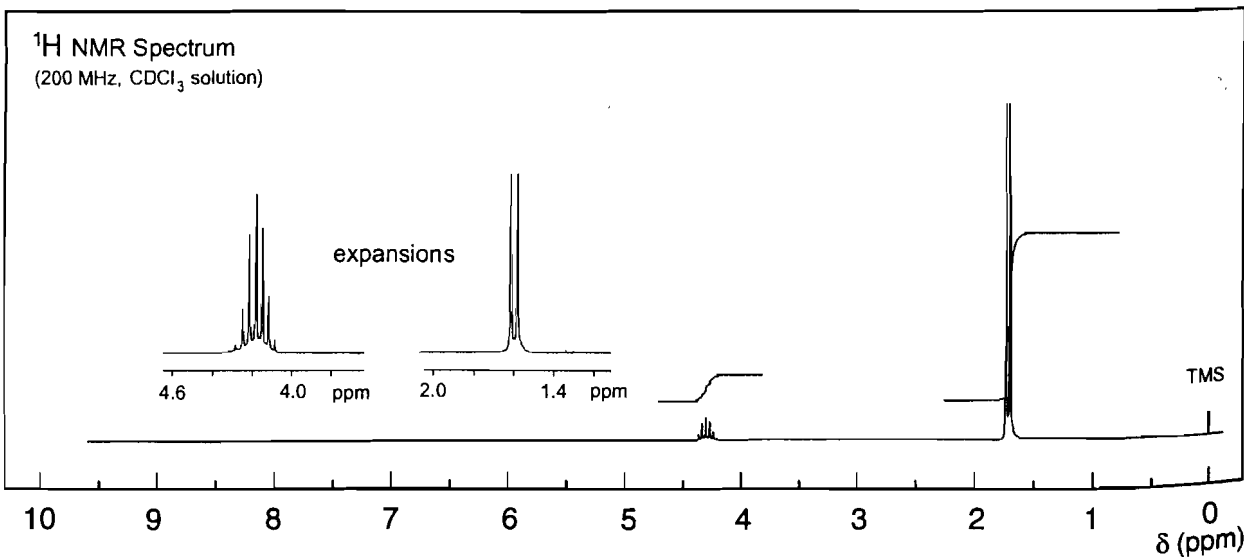
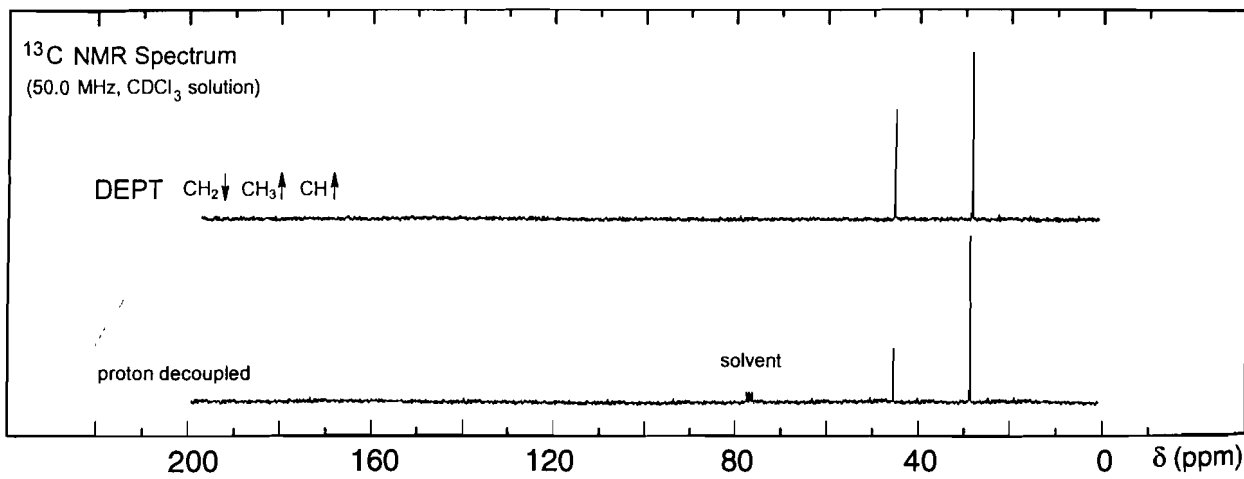

## Problem 16

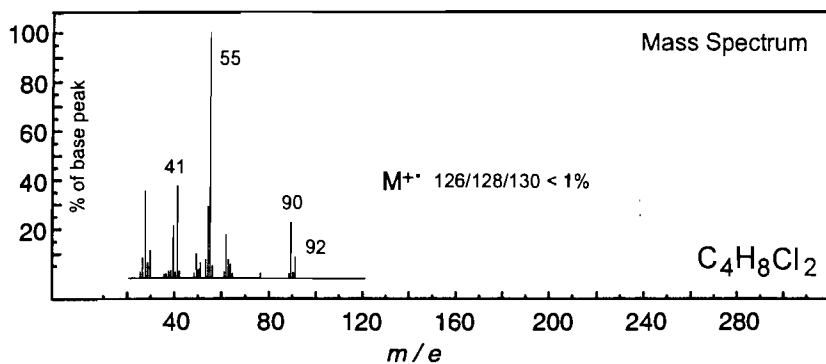
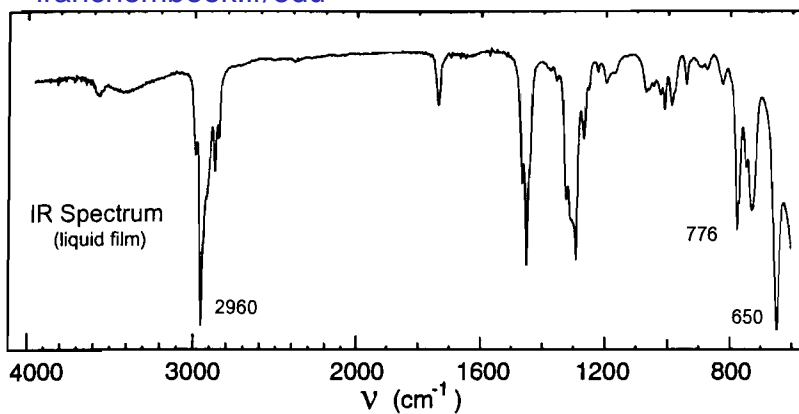

No significant UV  
absorption above 220 nm

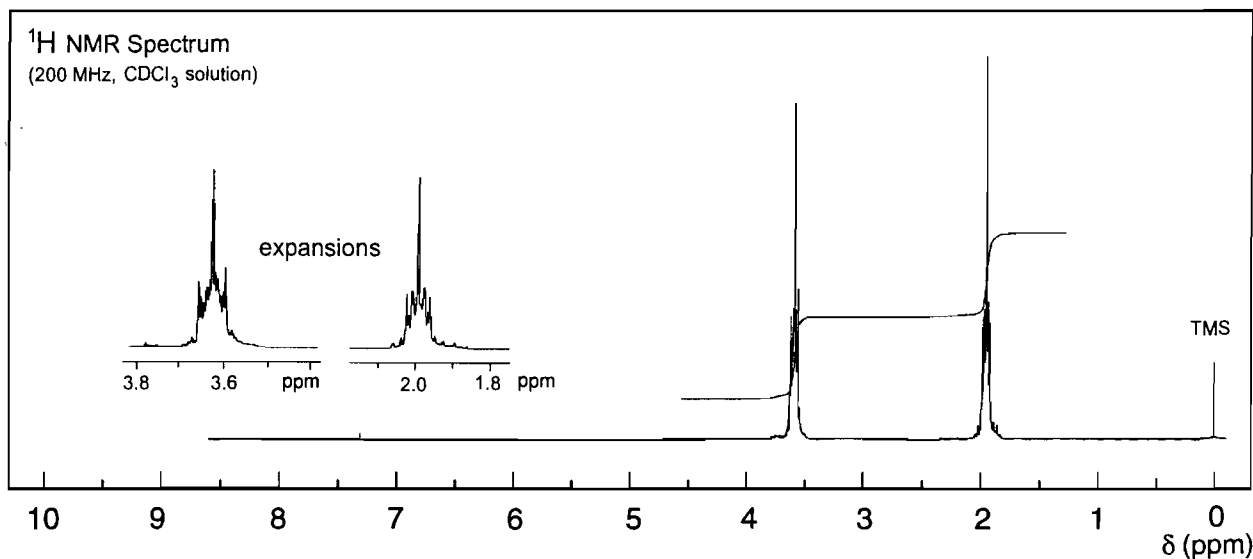
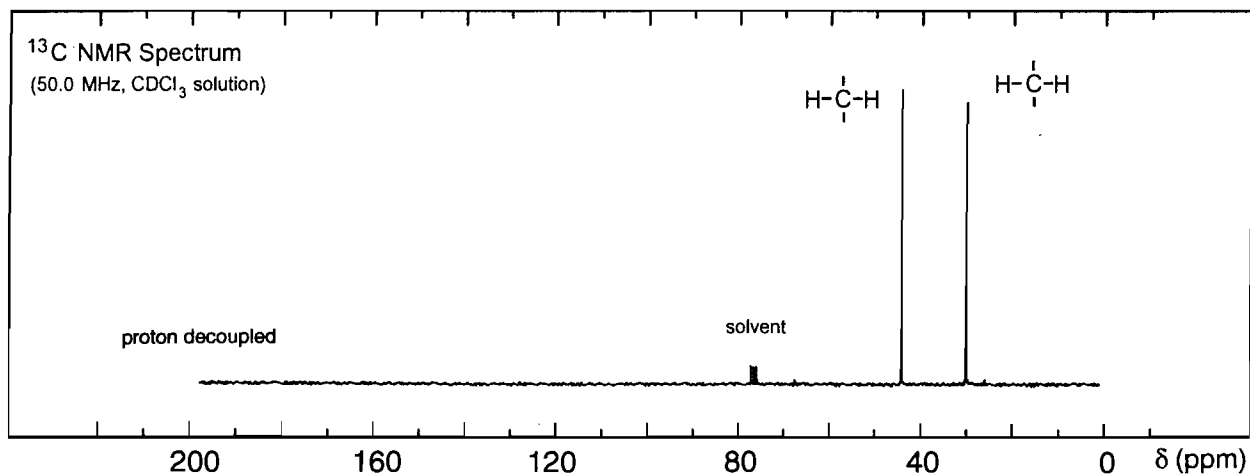

## Problem 17

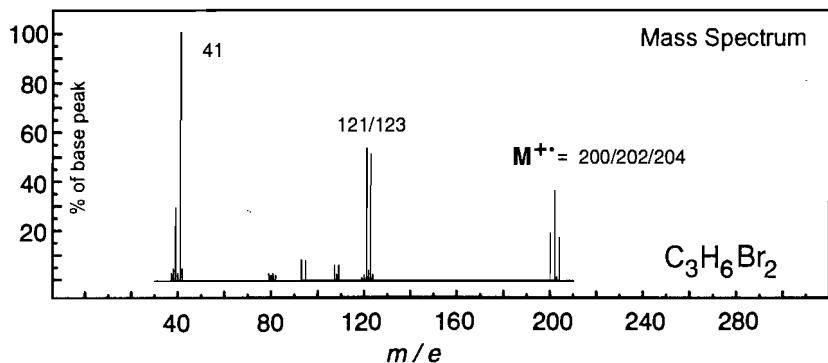
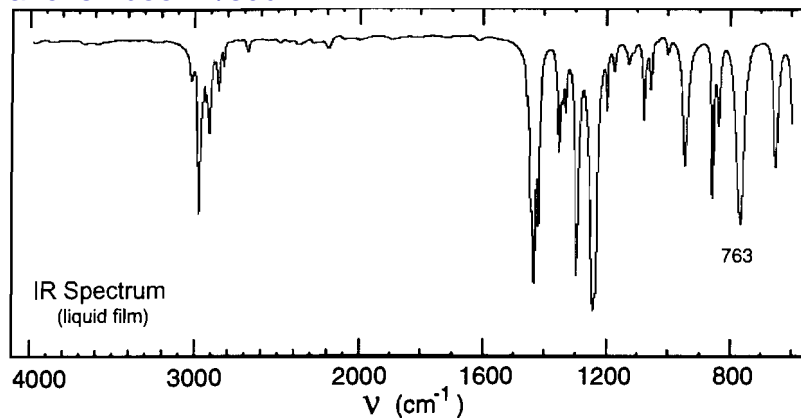

No significant UV  
absorption above 220 nm

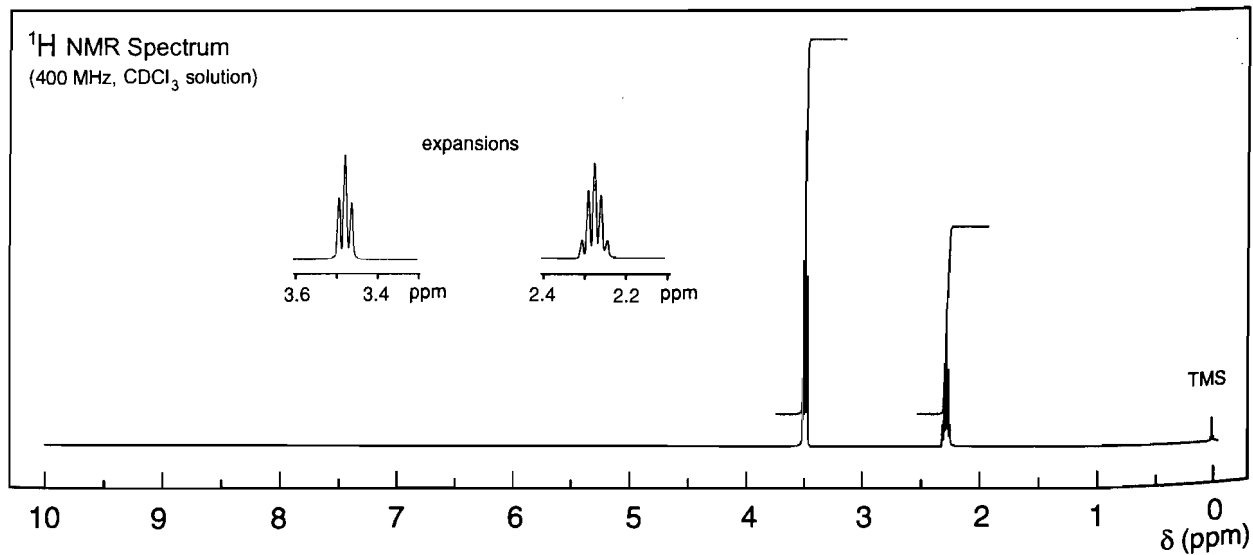
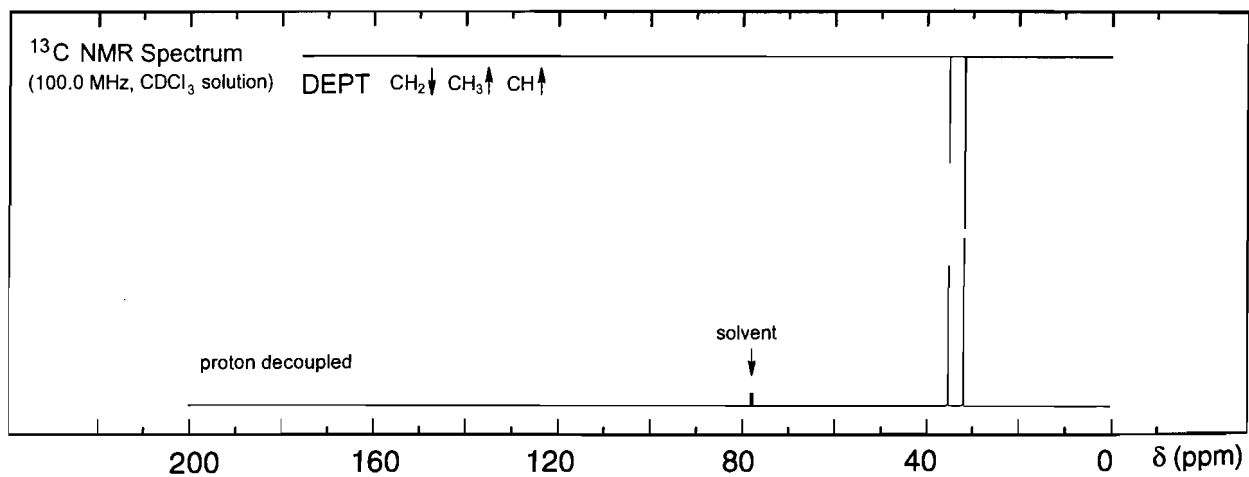

## Problem 18

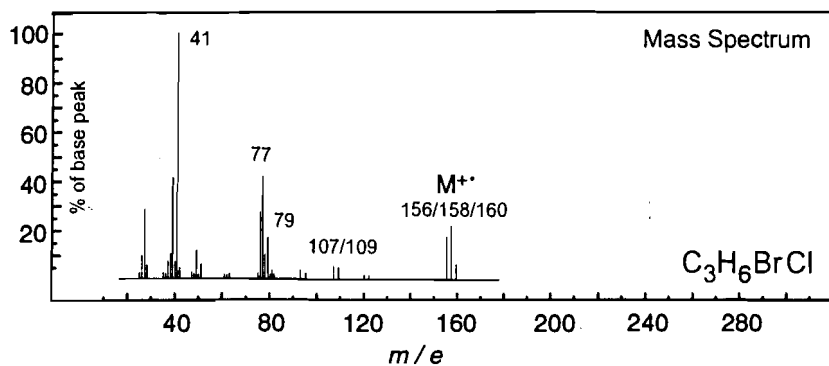
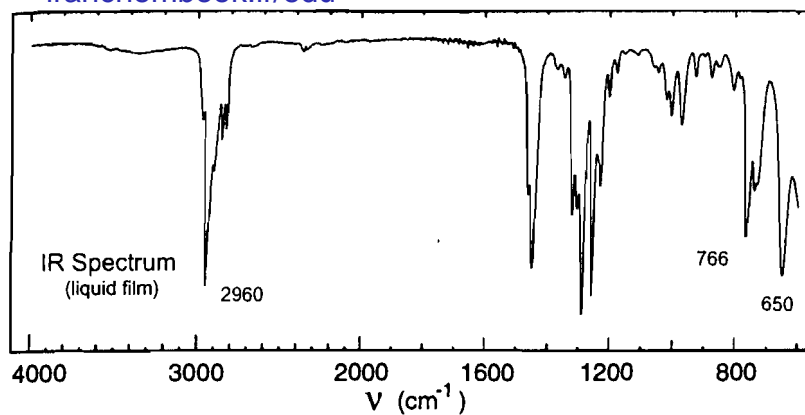

No significant UV  
absorption above 220 nm

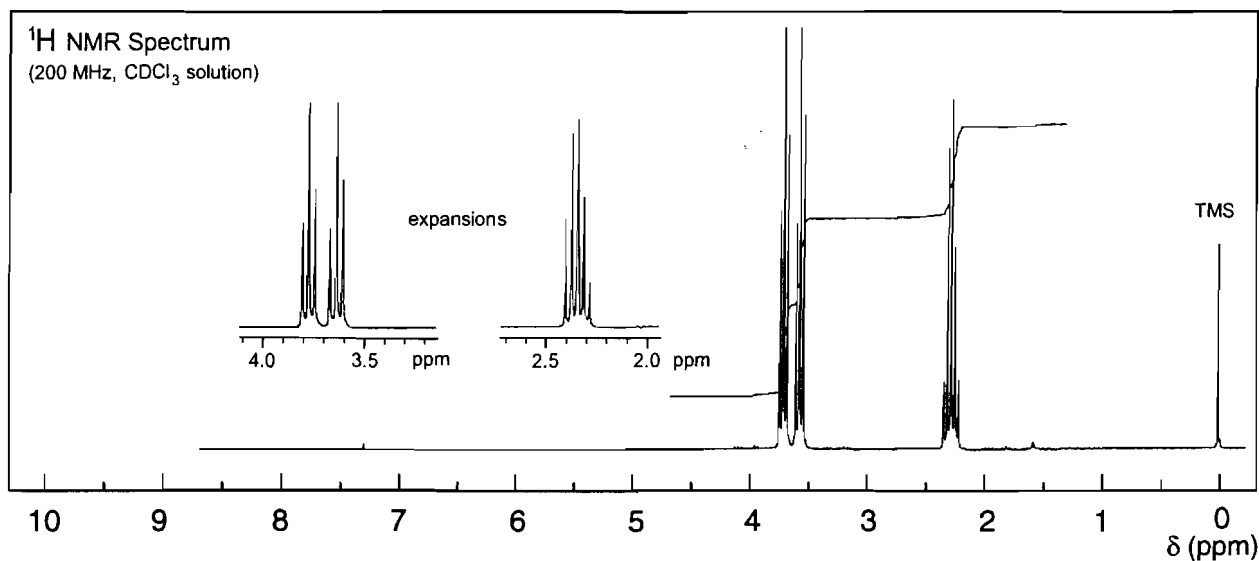
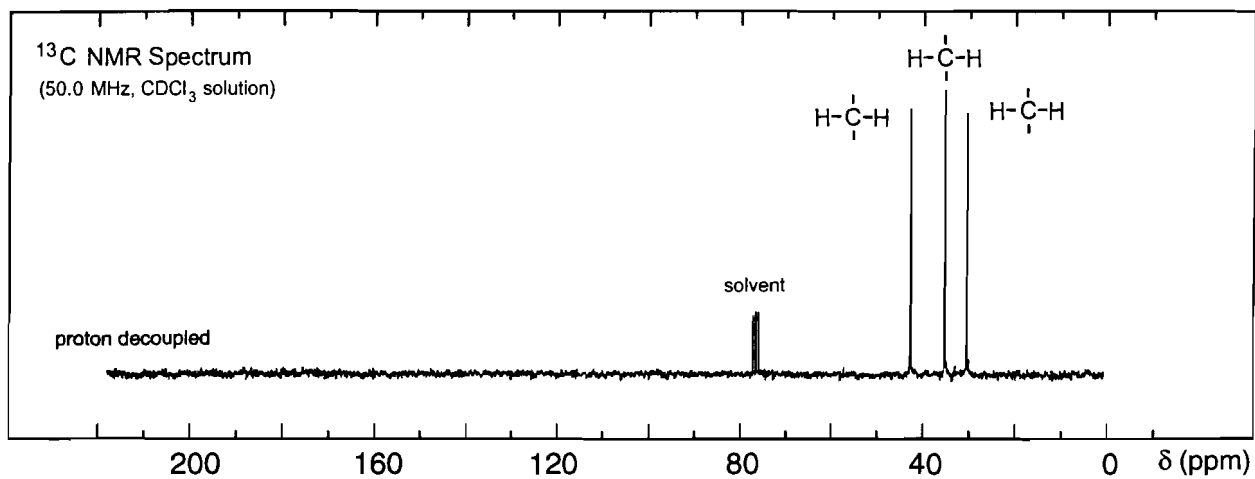

## Problem 19

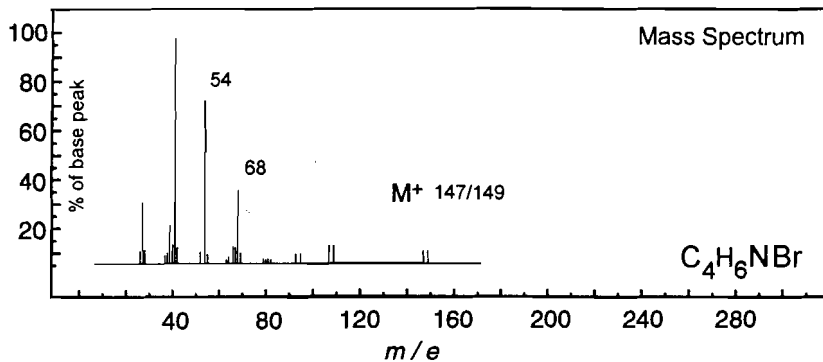
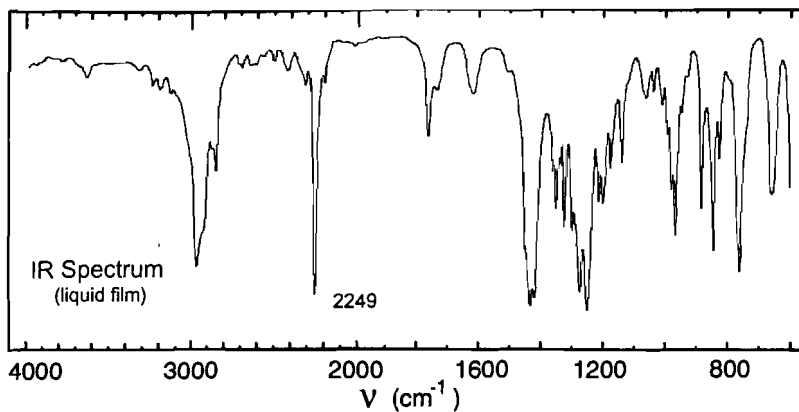

No significant UV  
absorption above 220 nm

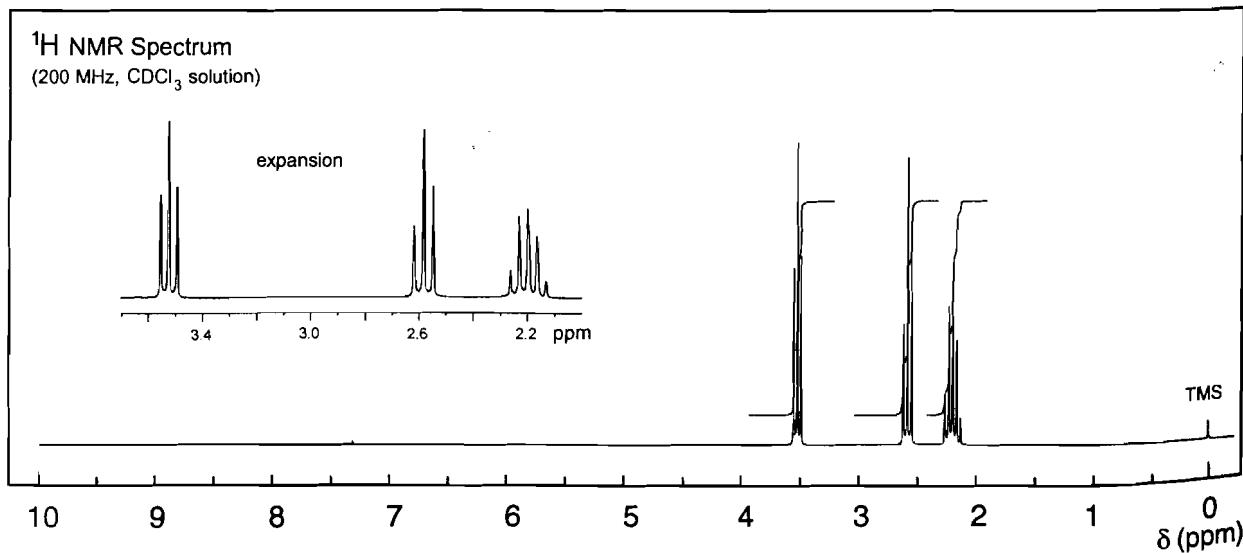
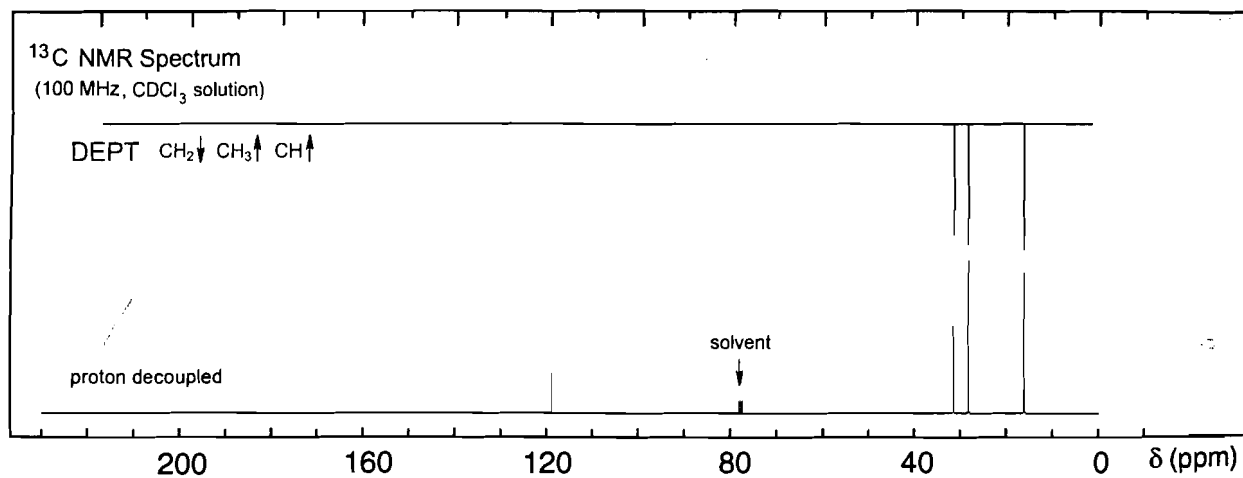

# Problem 20

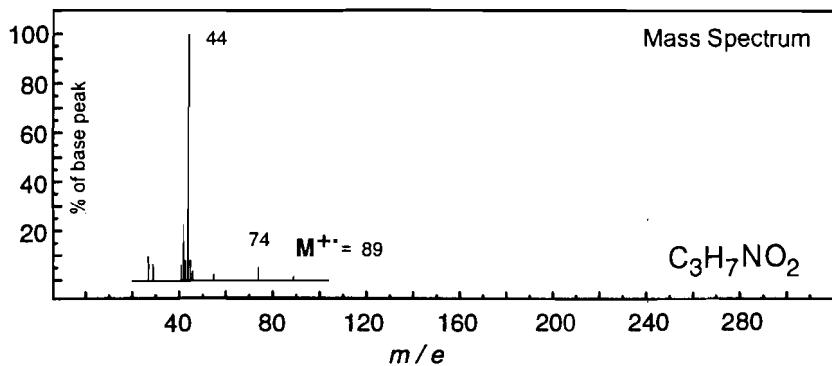
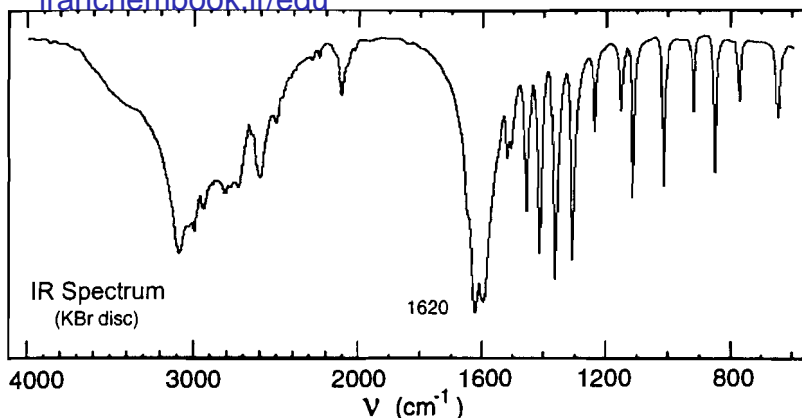

No significant UV  
absorption above 220 nm

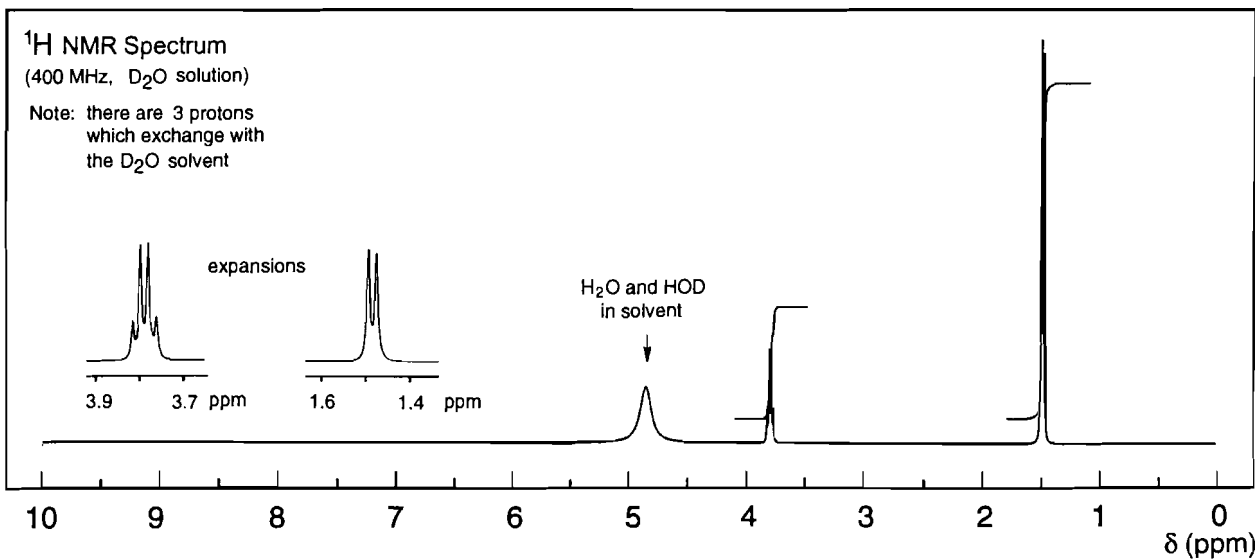
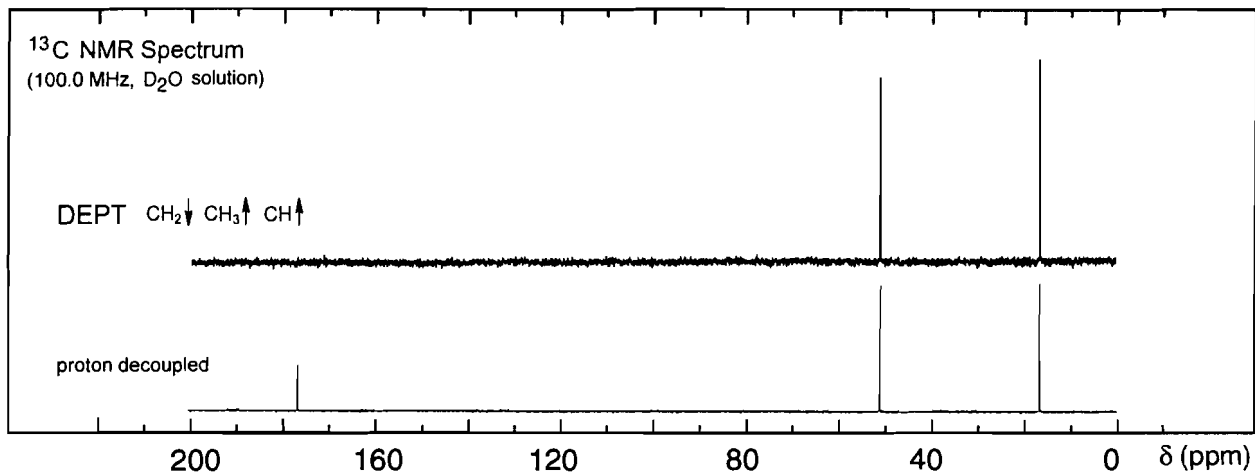

## Problem 21

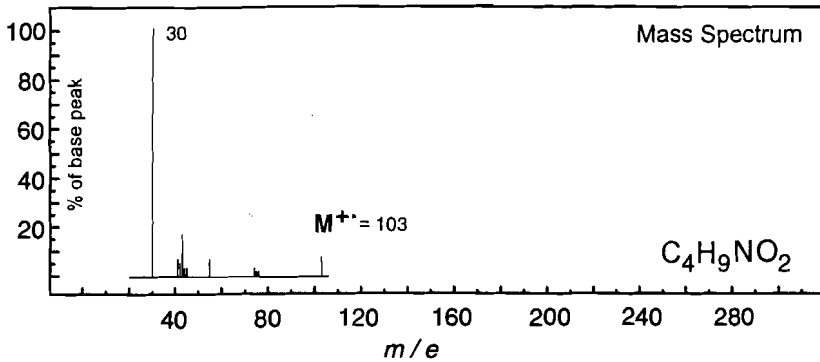
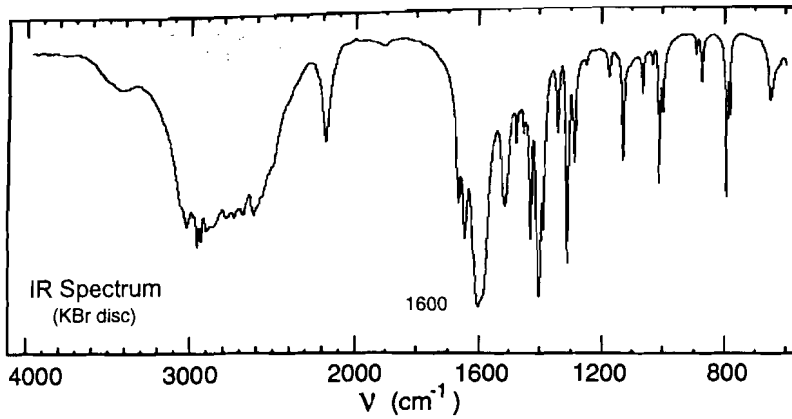

No significant UV  
absorption above 220 nm

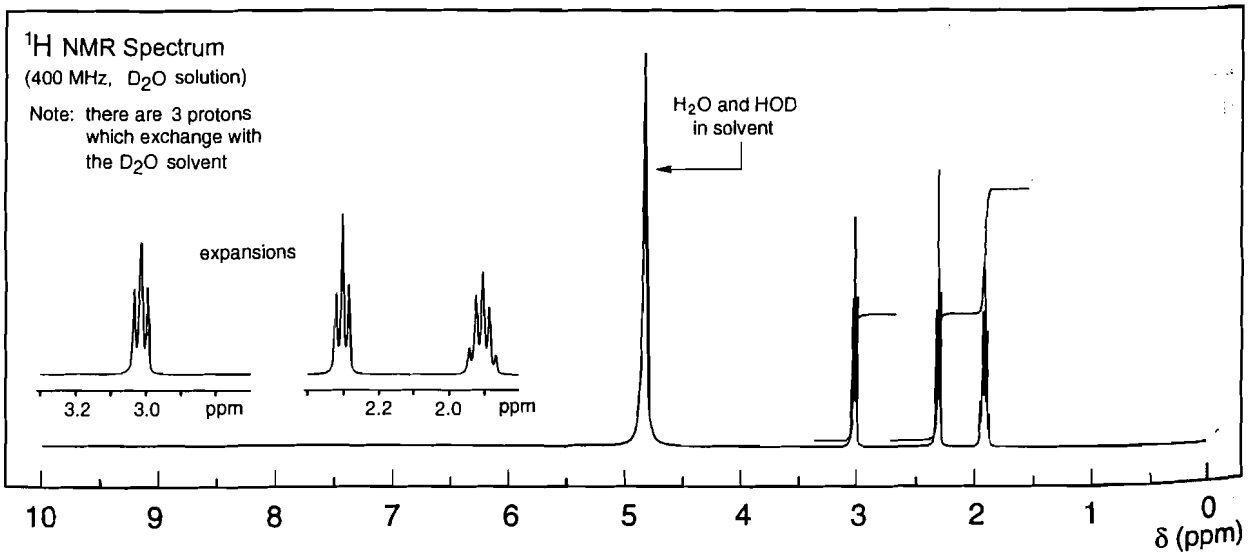
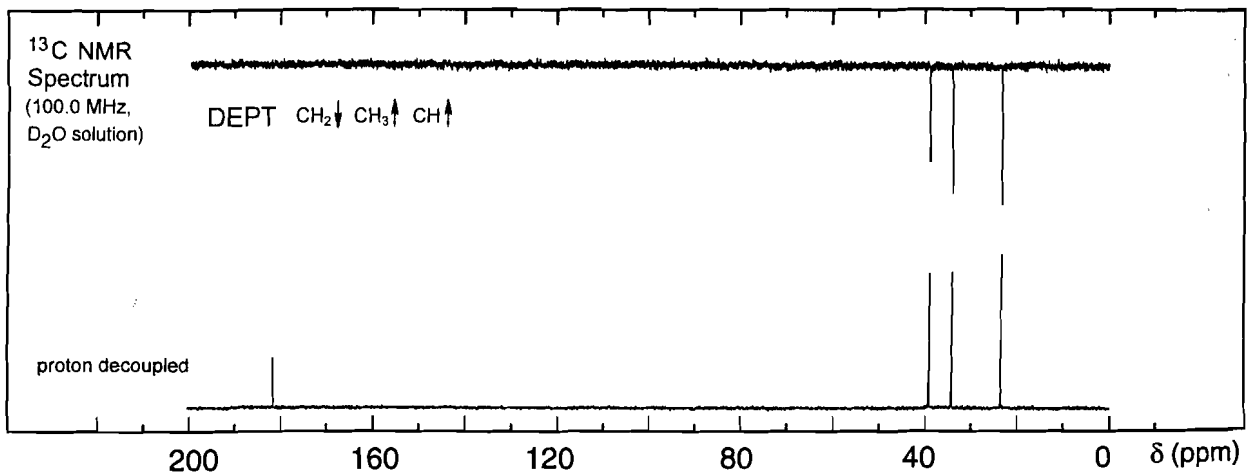

# Problem 22

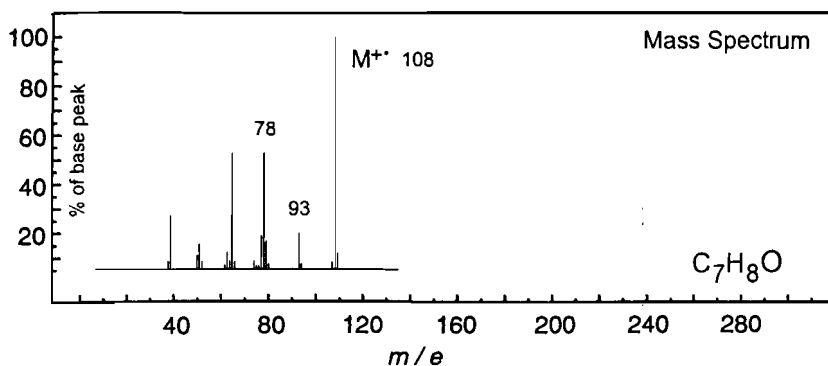
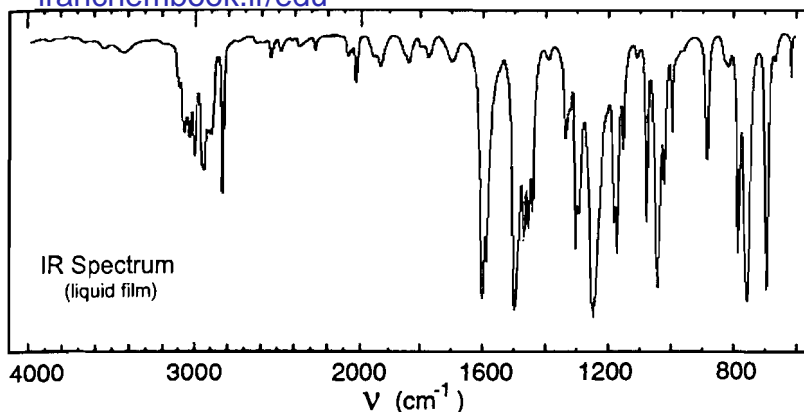

UV Spectrum  
λ<sub>max</sub> 269 nm (log<sub>10</sub> ε 3.2)  
solvent : methanol

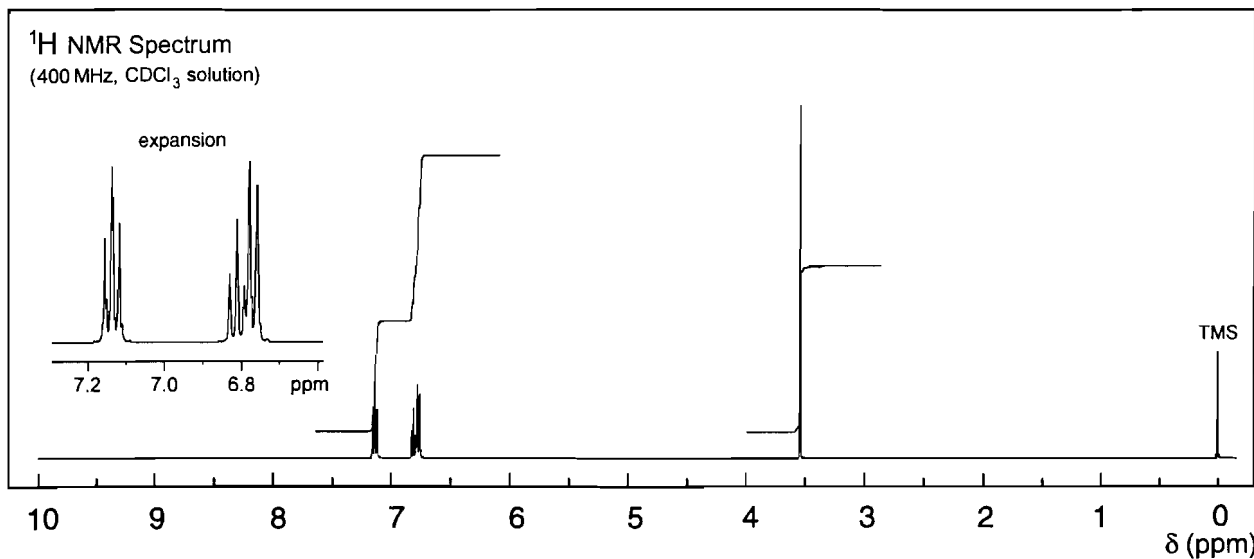
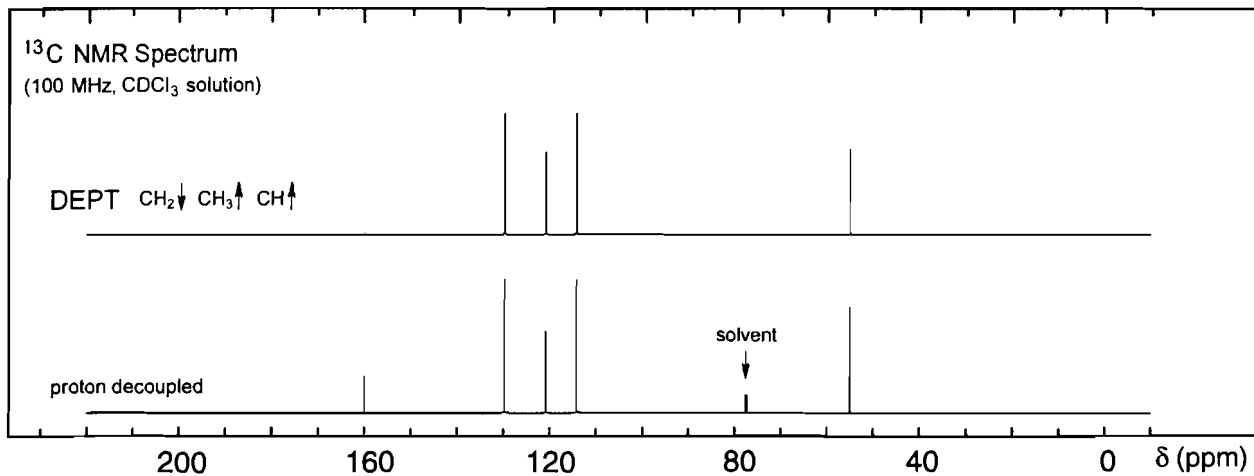



## Problem 23

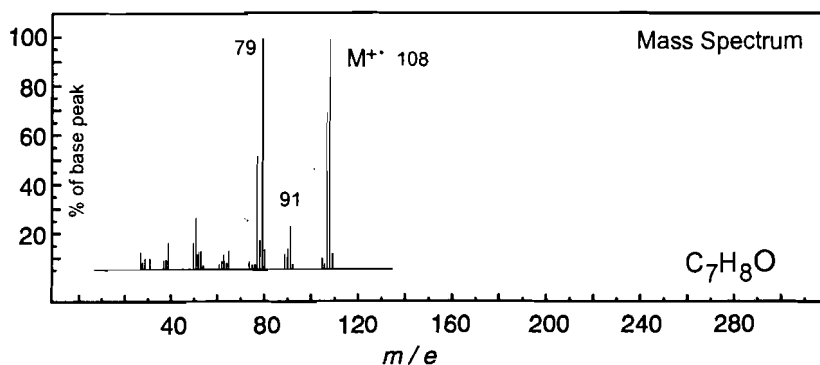
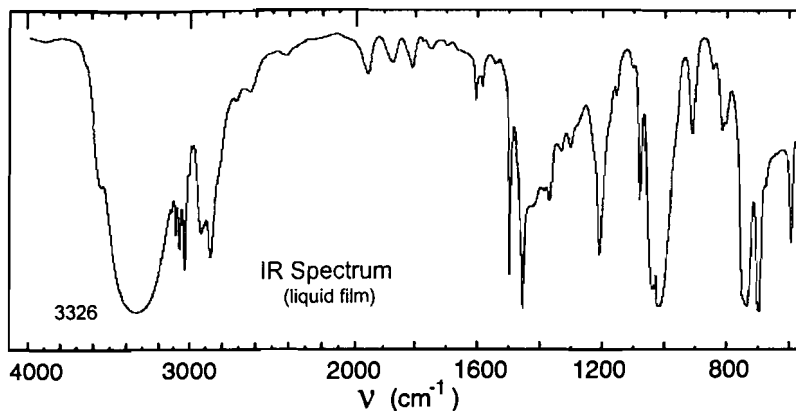

UV Spectrum

 $\lambda_{\text{max}}$  243 nm ( $\log_{10} \epsilon$  1.9) $\lambda_{\text{max}}$  248 nm ( $\log_{10} \epsilon$  2.1) $\lambda_{\text{max}}$  252 nm ( $\log_{10} \epsilon$  2.2) $\lambda_{\text{max}}$  258 nm ( $\log_{10} \epsilon$  2.3) $\lambda_{\text{max}}$  264 nm ( $\log_{10} \epsilon$  2.1) $\lambda_{\text{max}}$  268 nm ( $\log_{10} \epsilon$  1.9)

solvent : ethanol

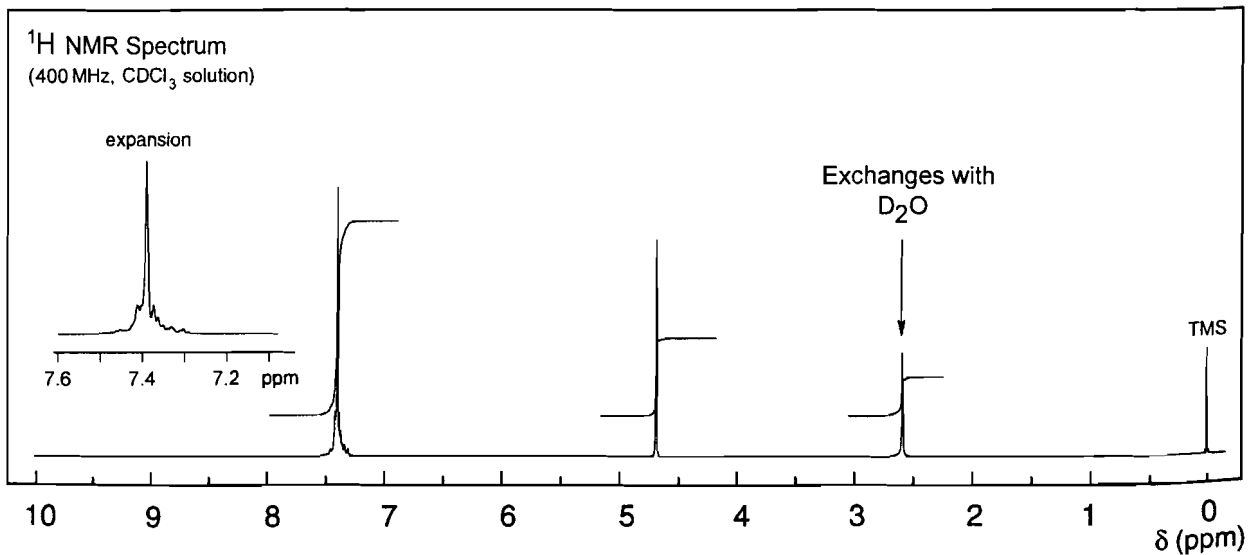
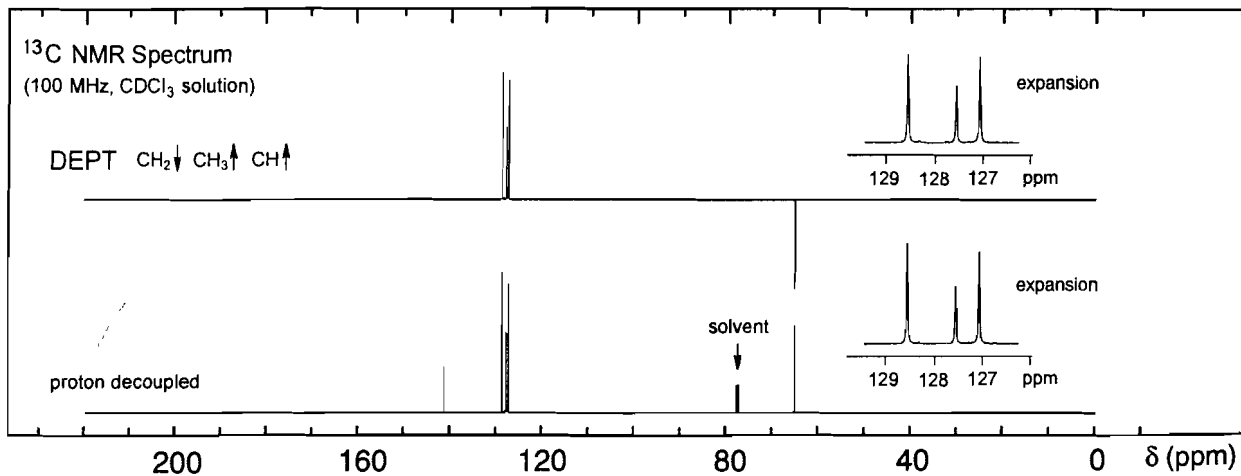

## Problem 24

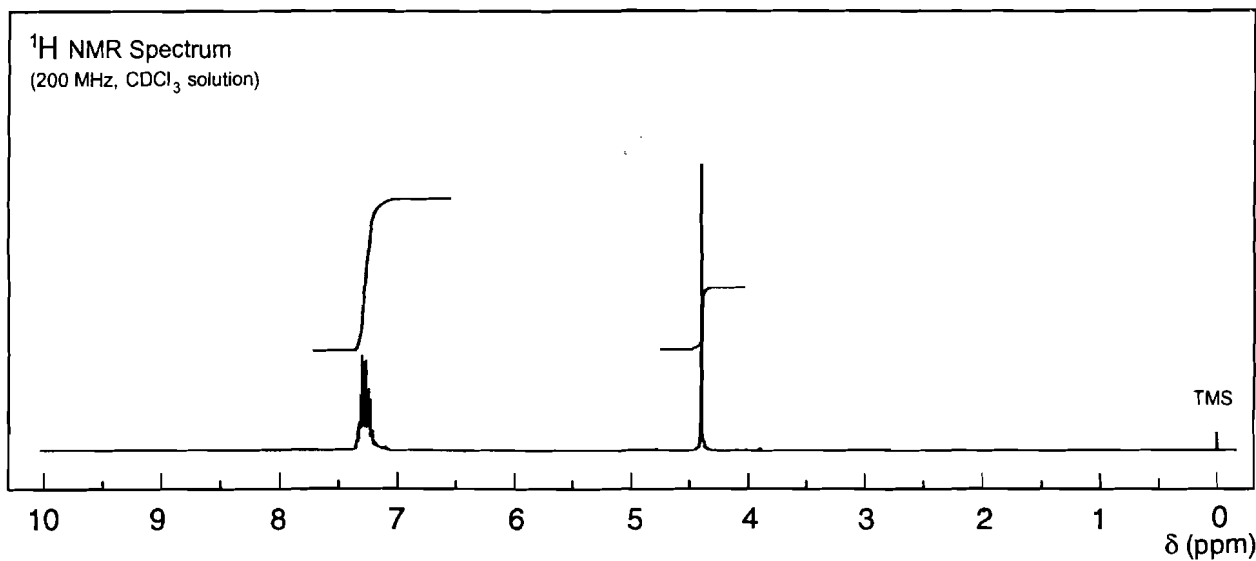
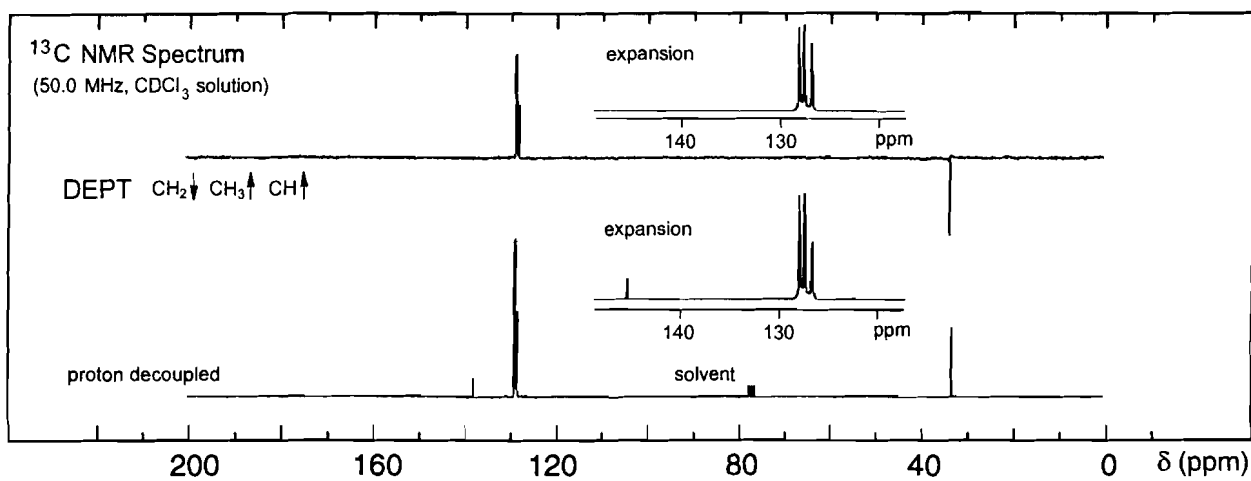
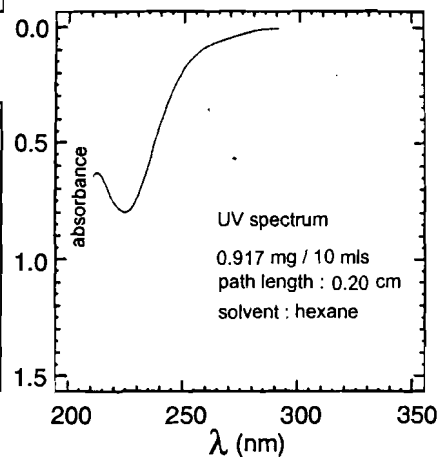
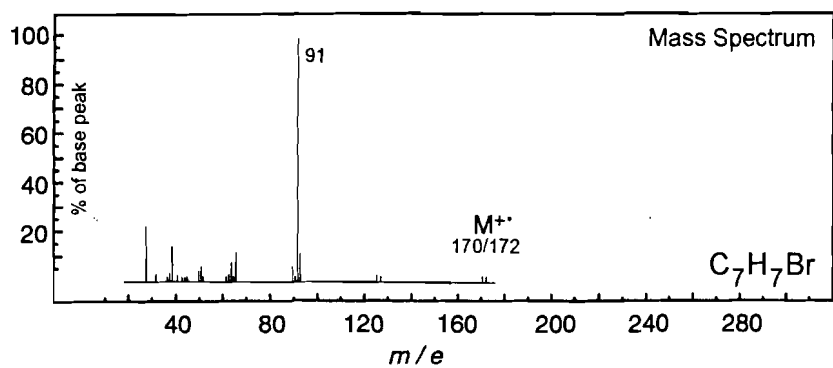
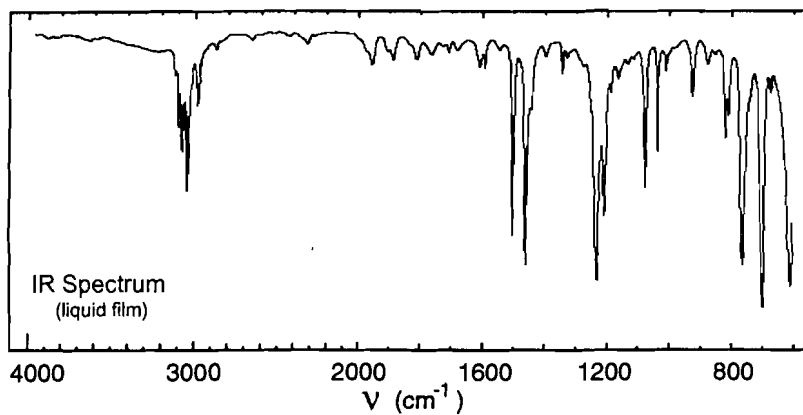

## Problem 25

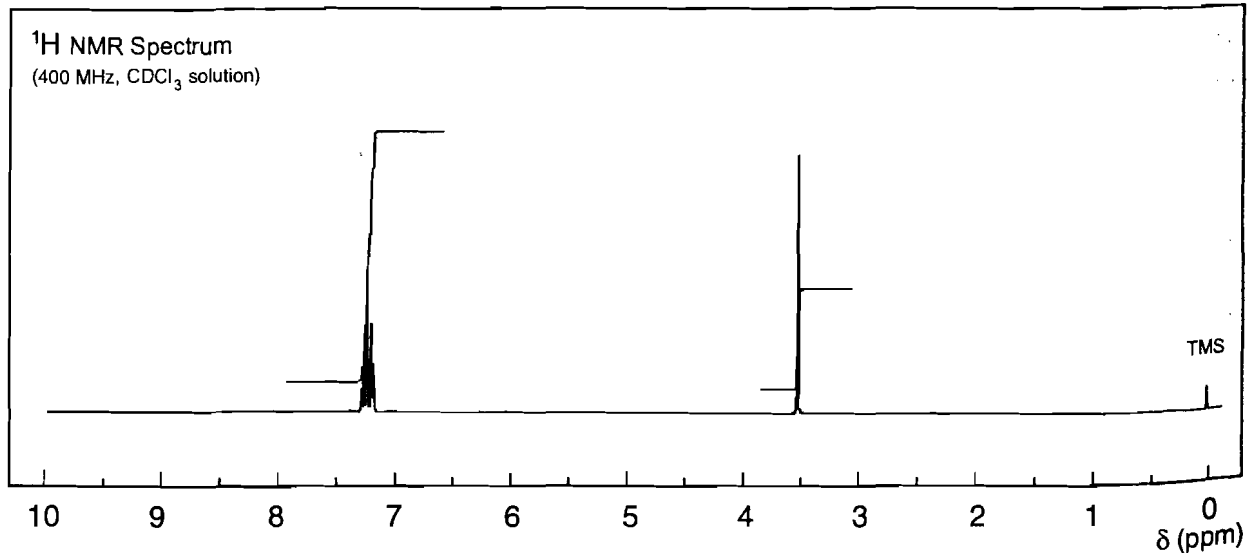
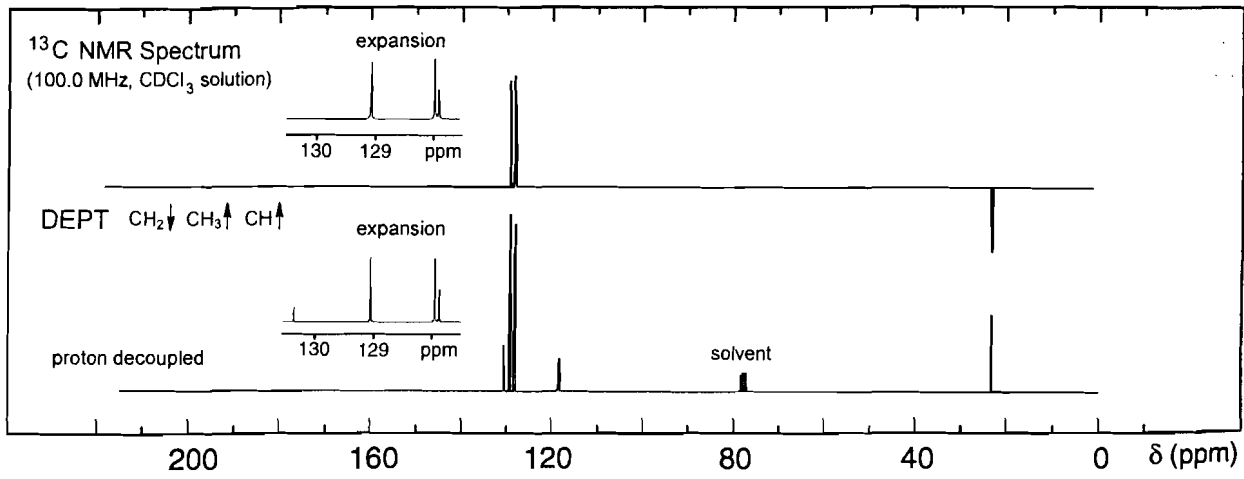
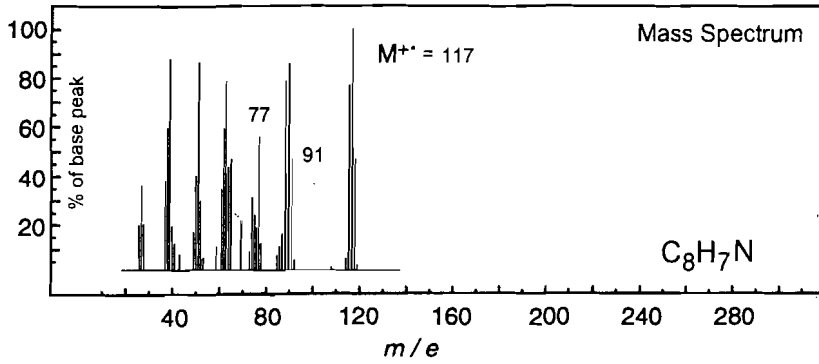
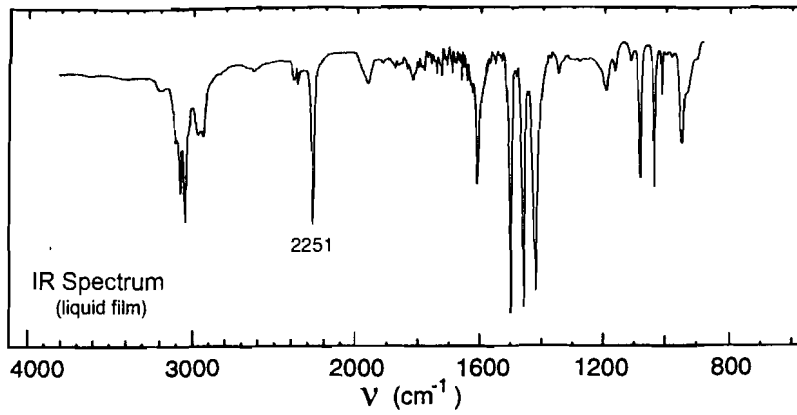

# Problem 26

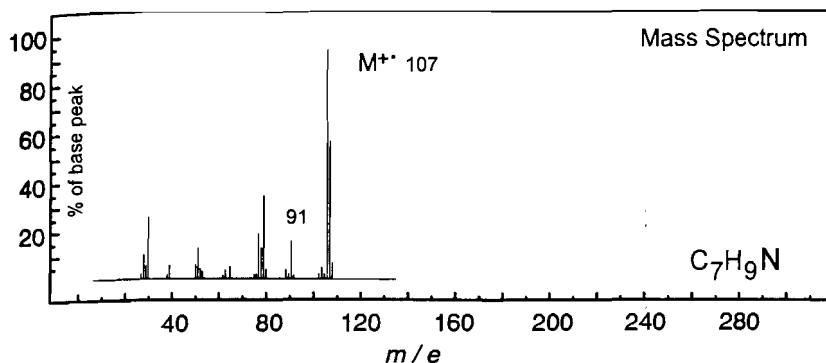
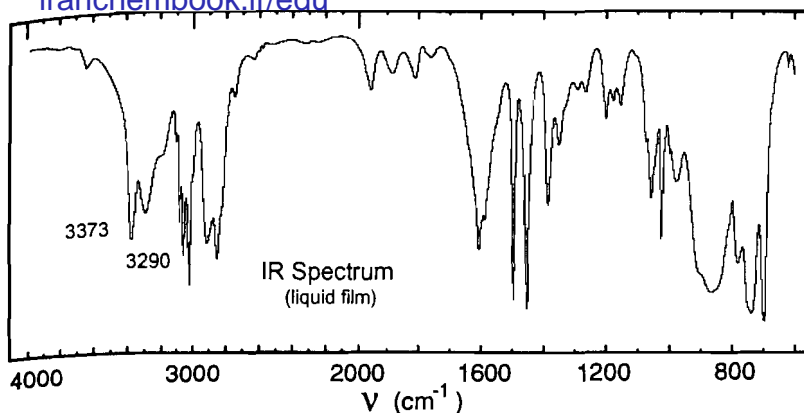

UV Spectrum

$\lambda_{\max}$  256 nm ( $\log_{10} \epsilon$  2.2)

$\lambda_{\max}$  264 nm ( $\log_{10} \epsilon$  2.1)

solvent : ethanol

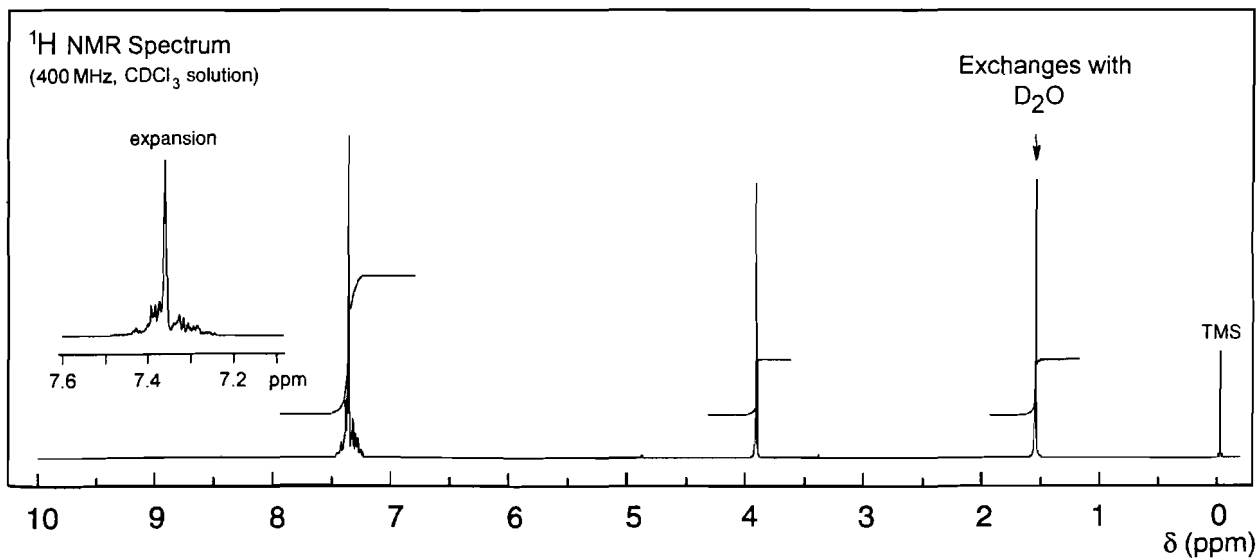
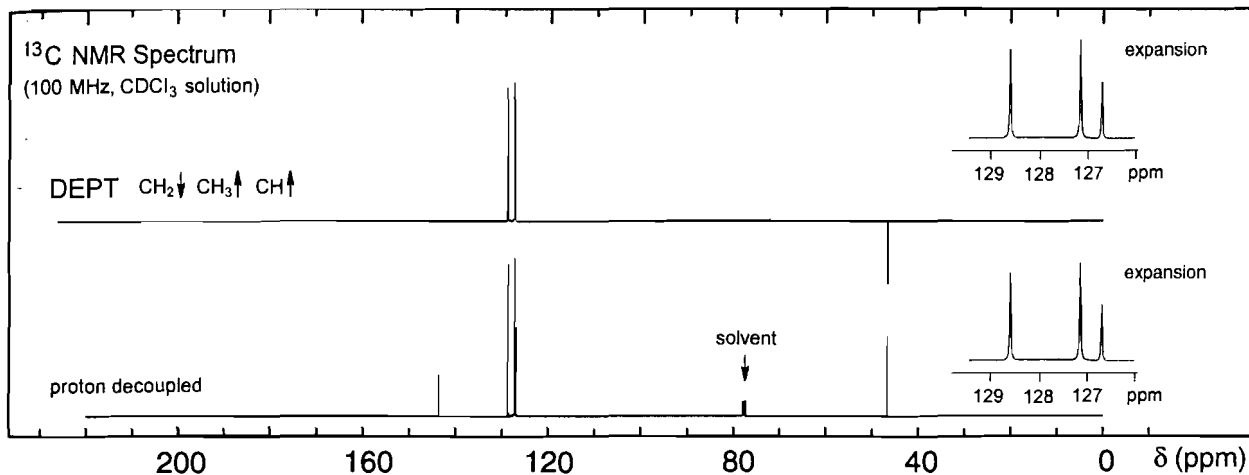

## Problem 27

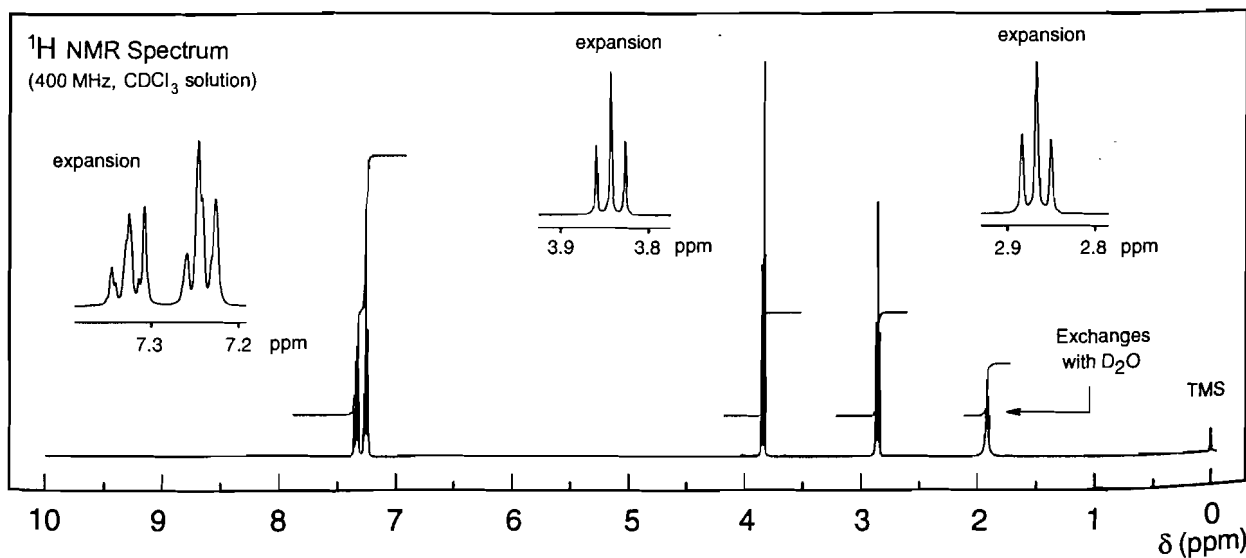
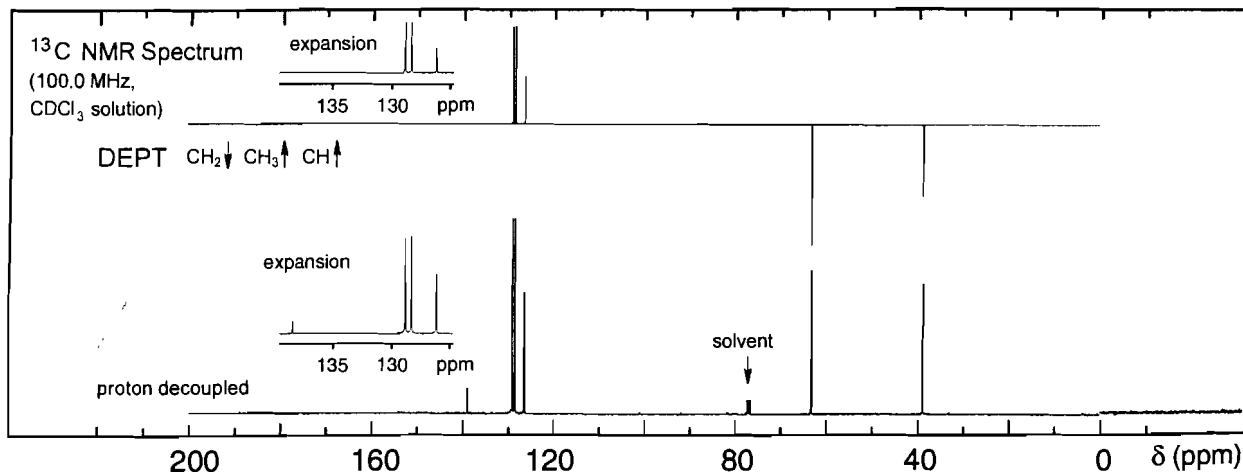
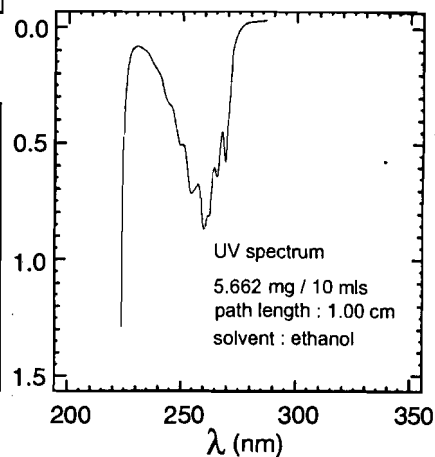
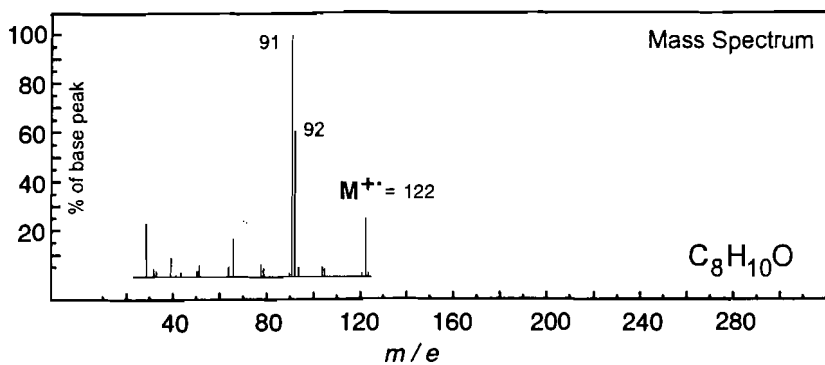
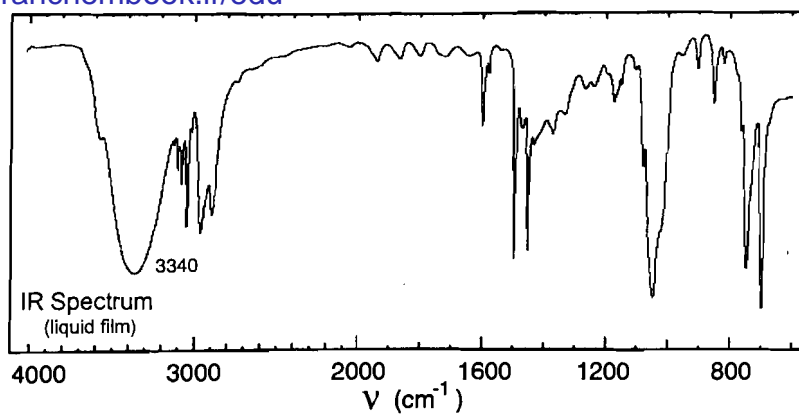

## Problem 28

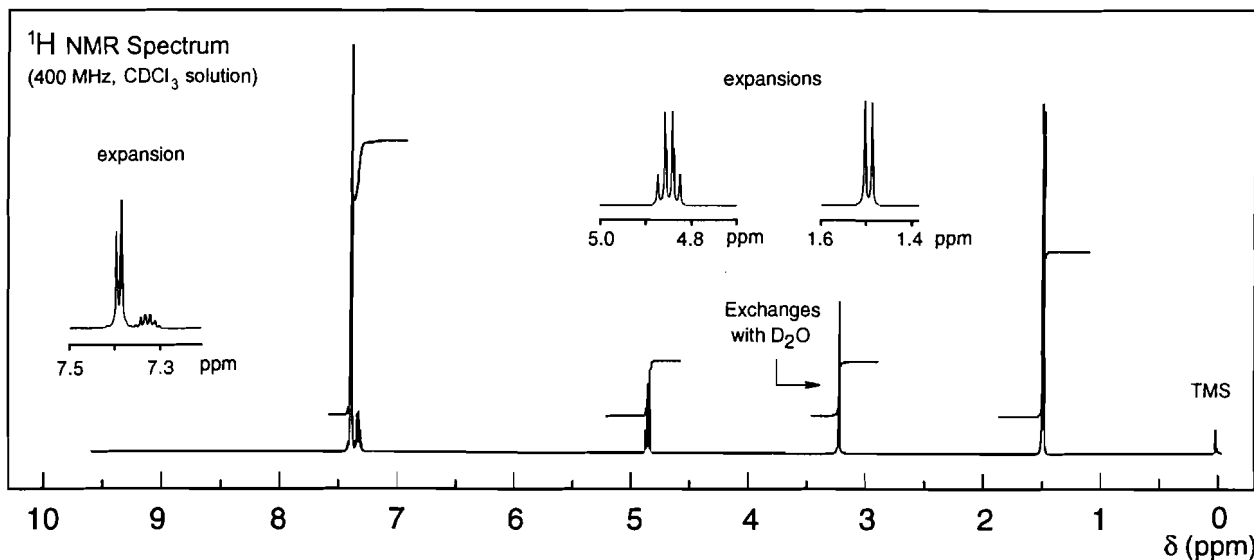
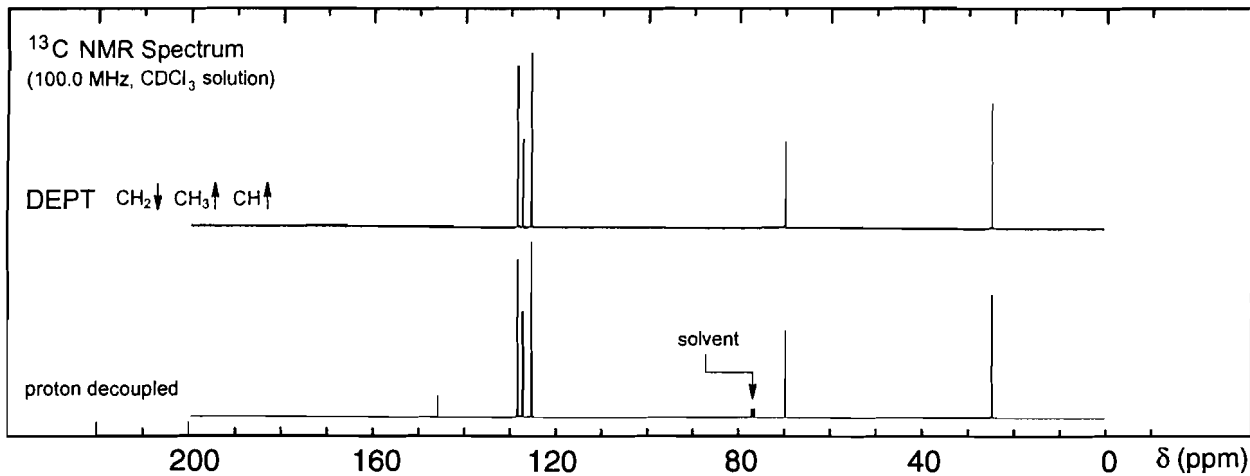
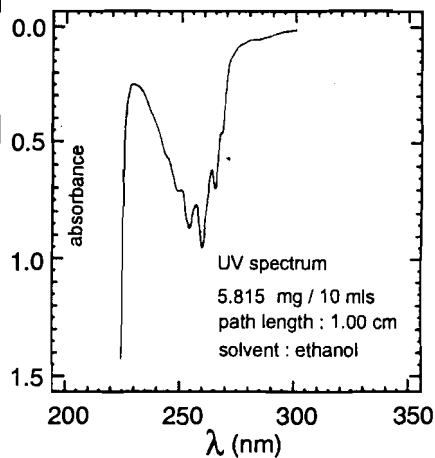
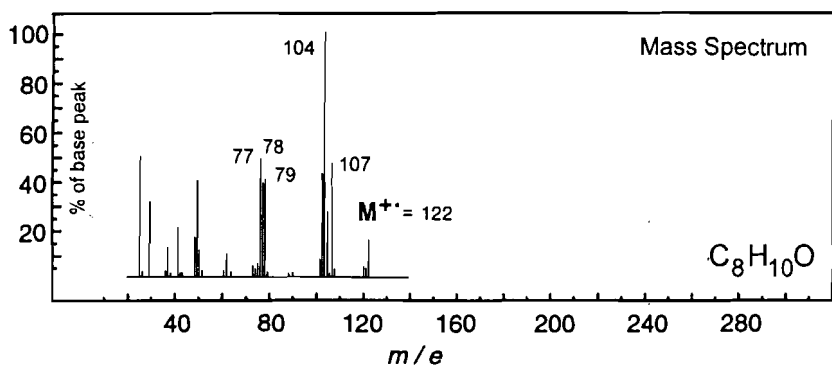
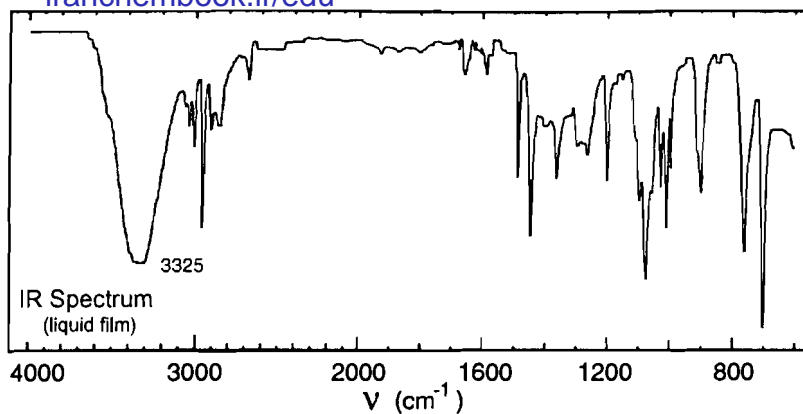

## Problem 29

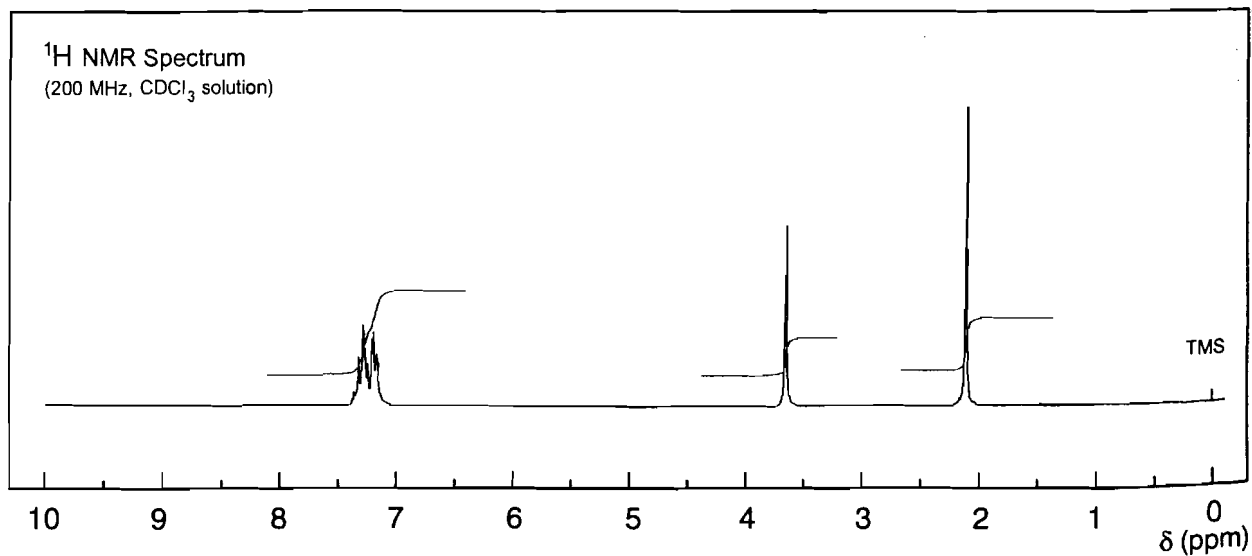
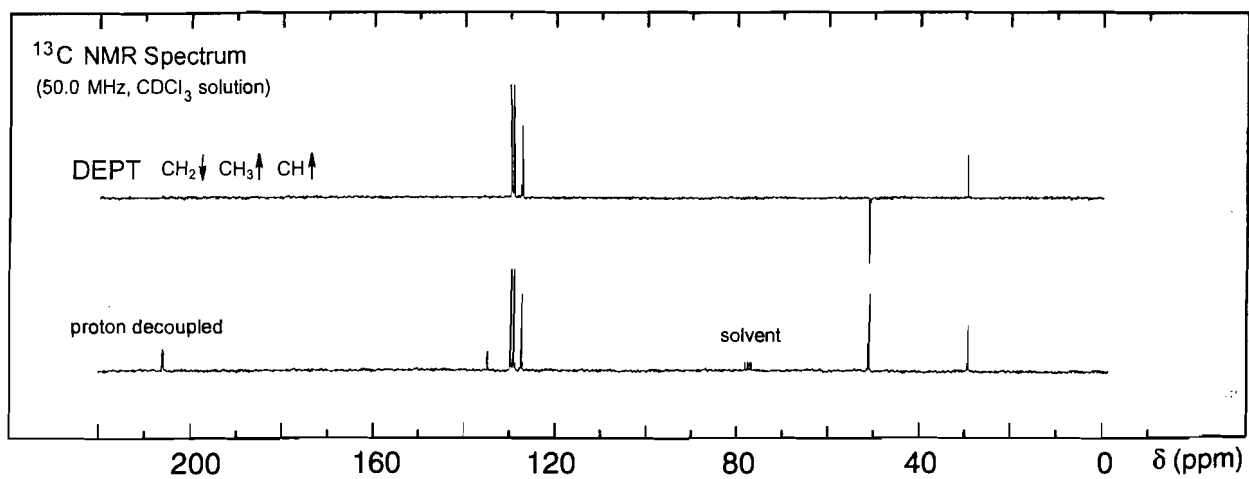
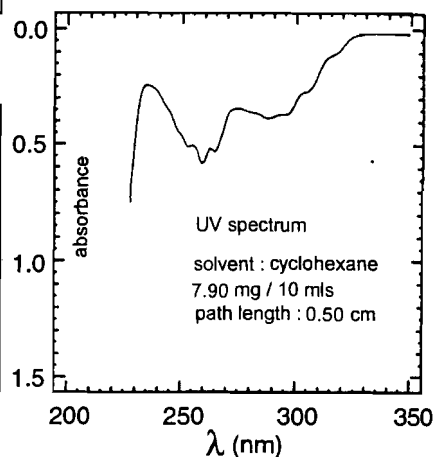
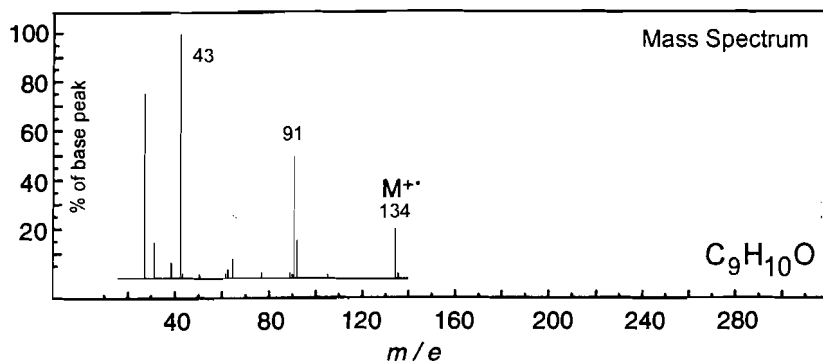
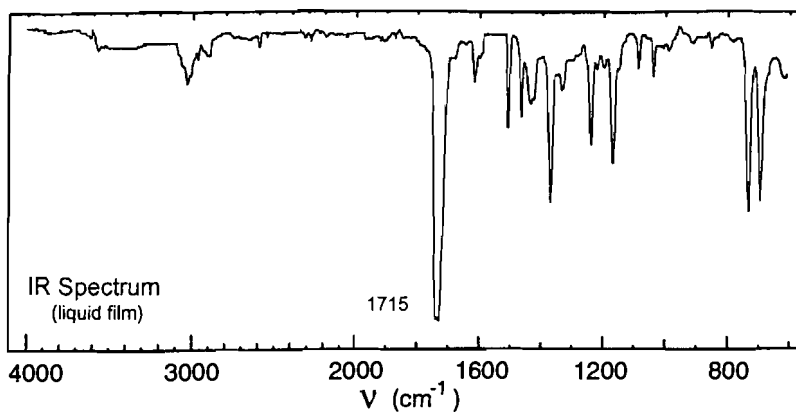

## Problem 30

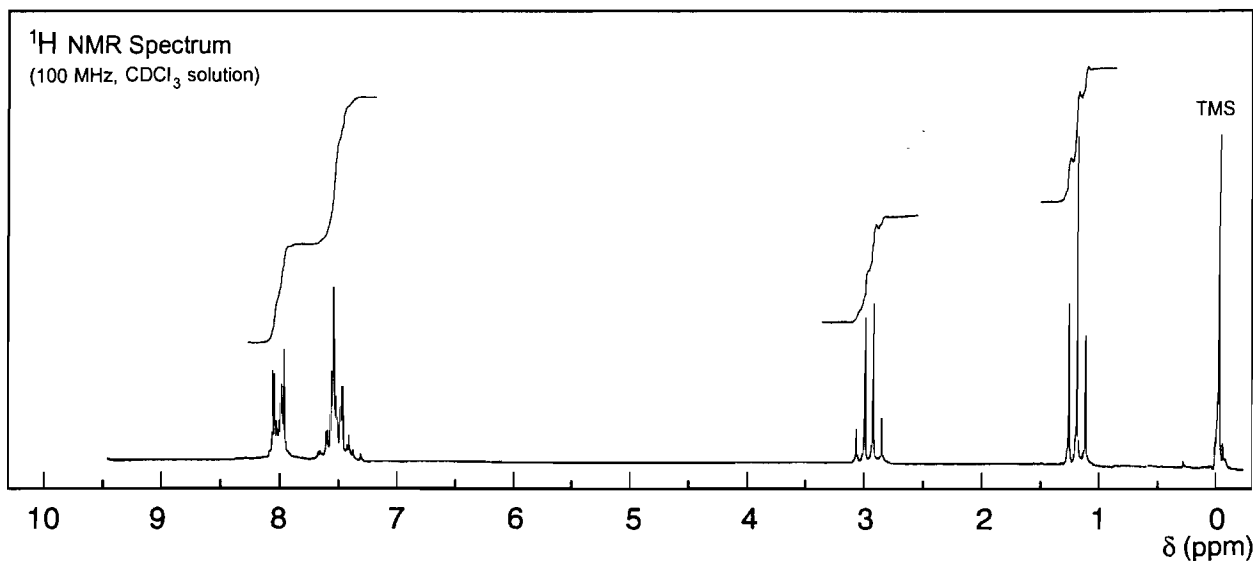
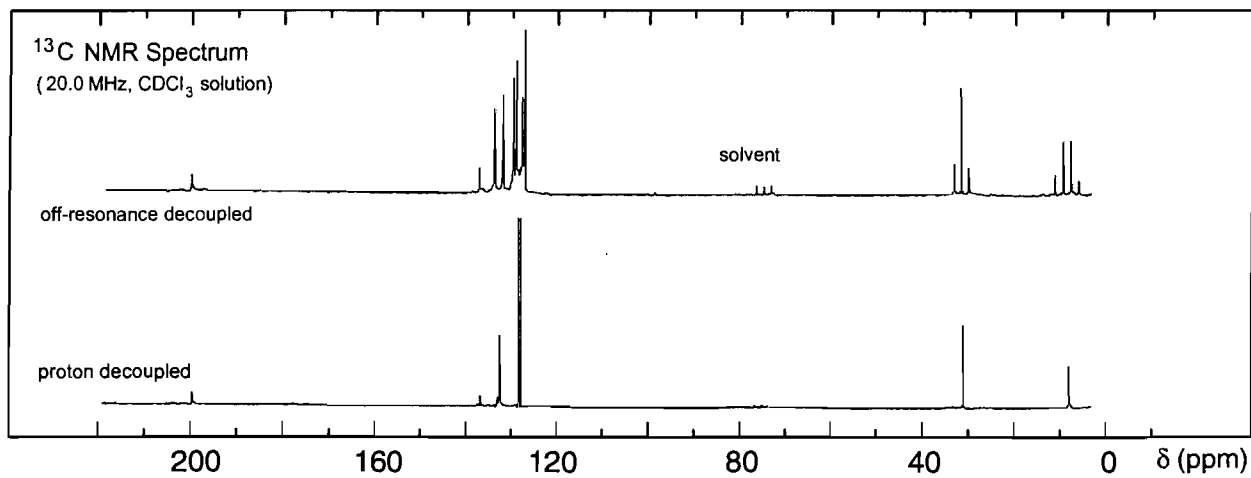
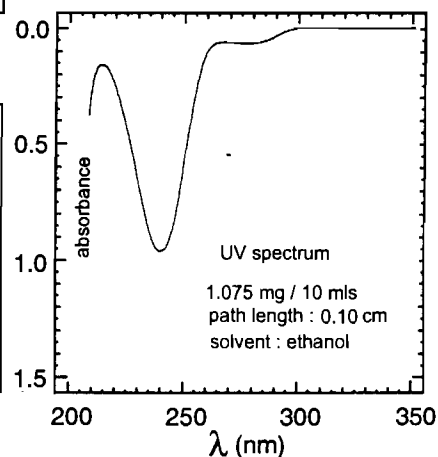
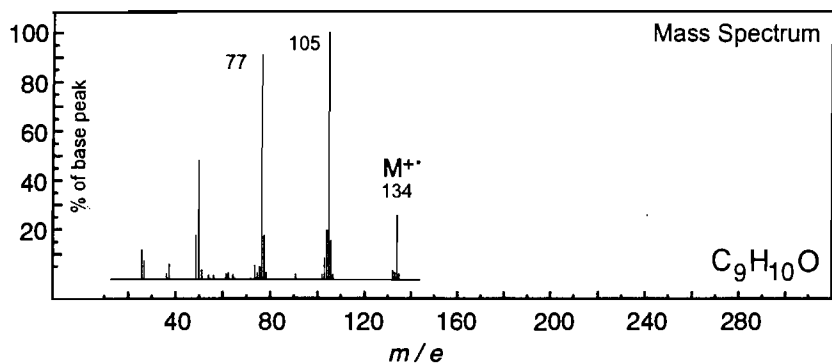
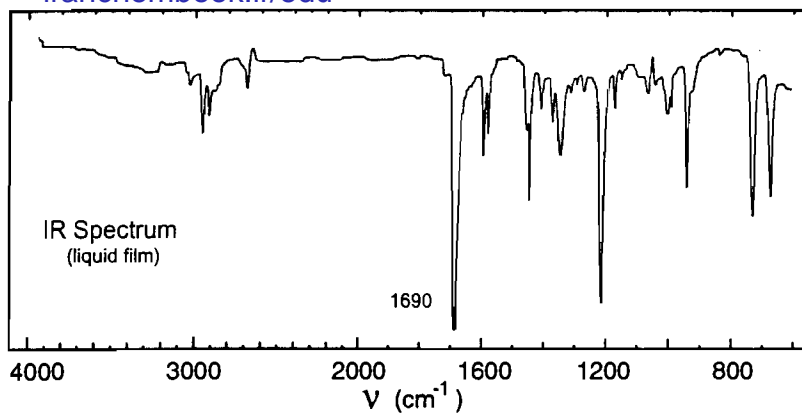



# Problem 31

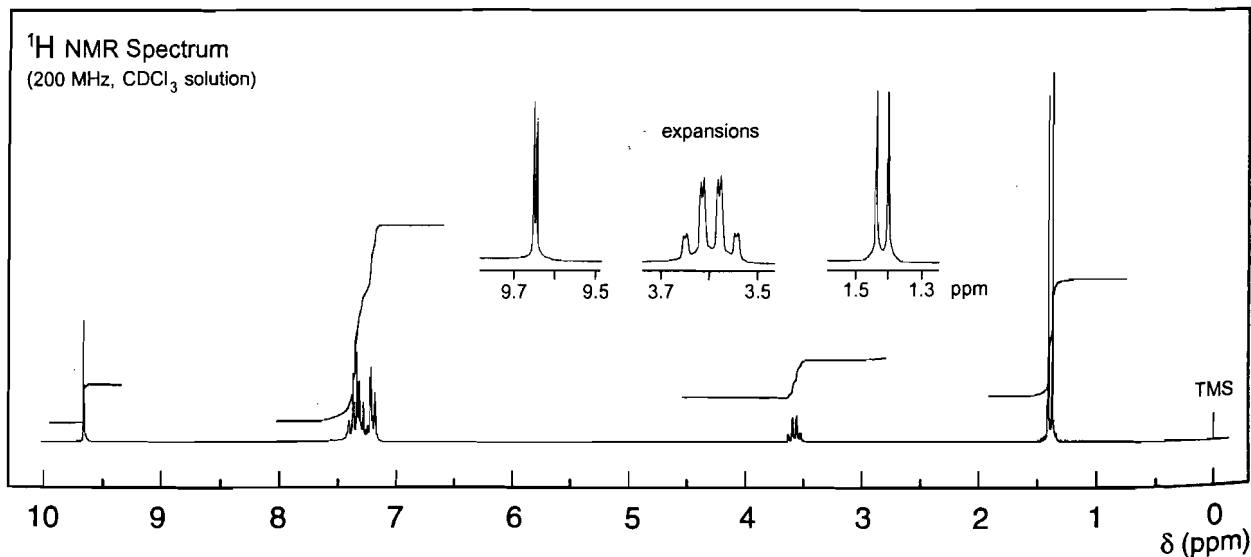
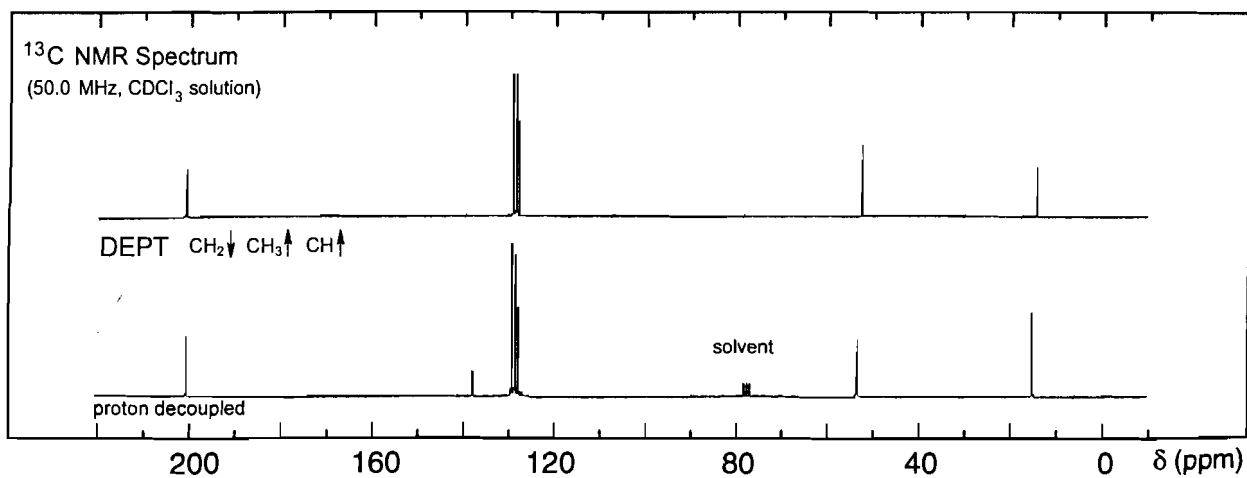
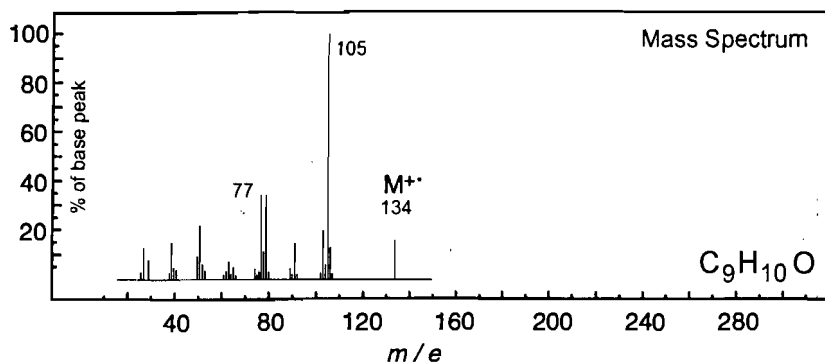
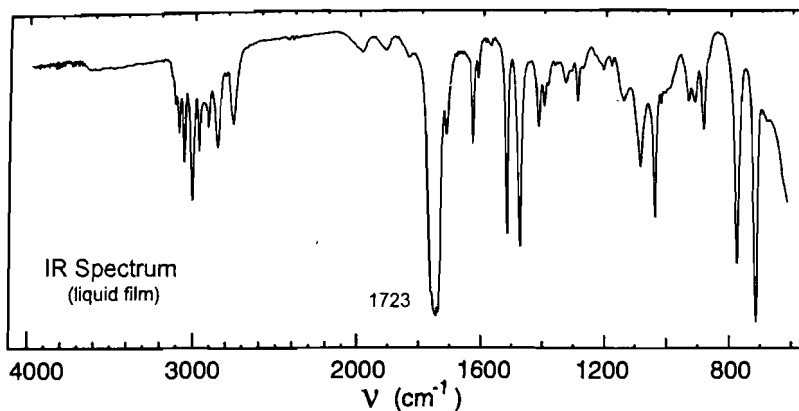

## Problem 32

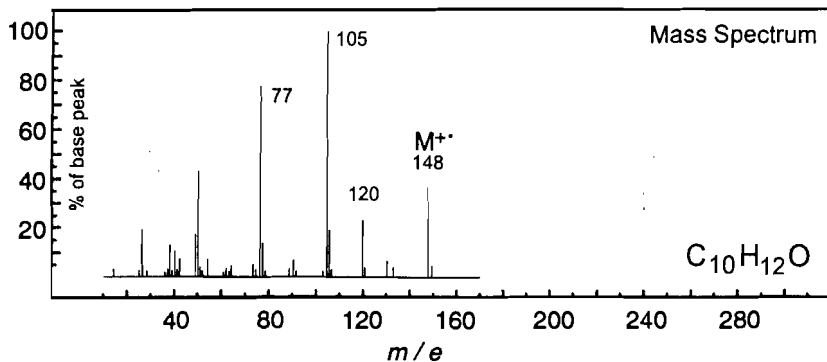
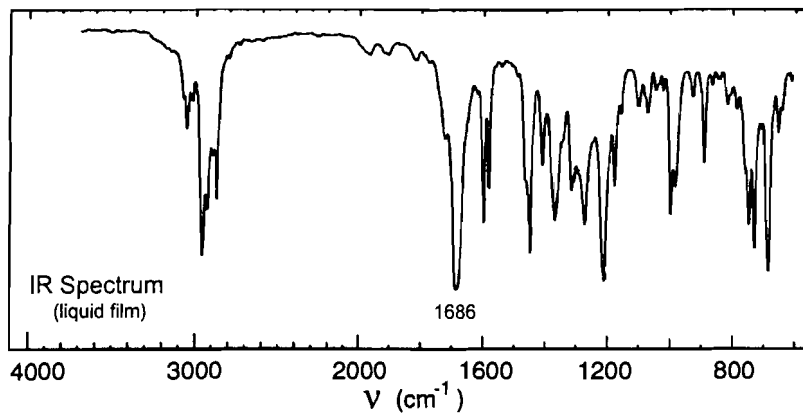

UV Spectrum

 $\lambda_{\text{max}}$  241 nm ( $\log_{10}\epsilon$  4.1)

solvent : methanol

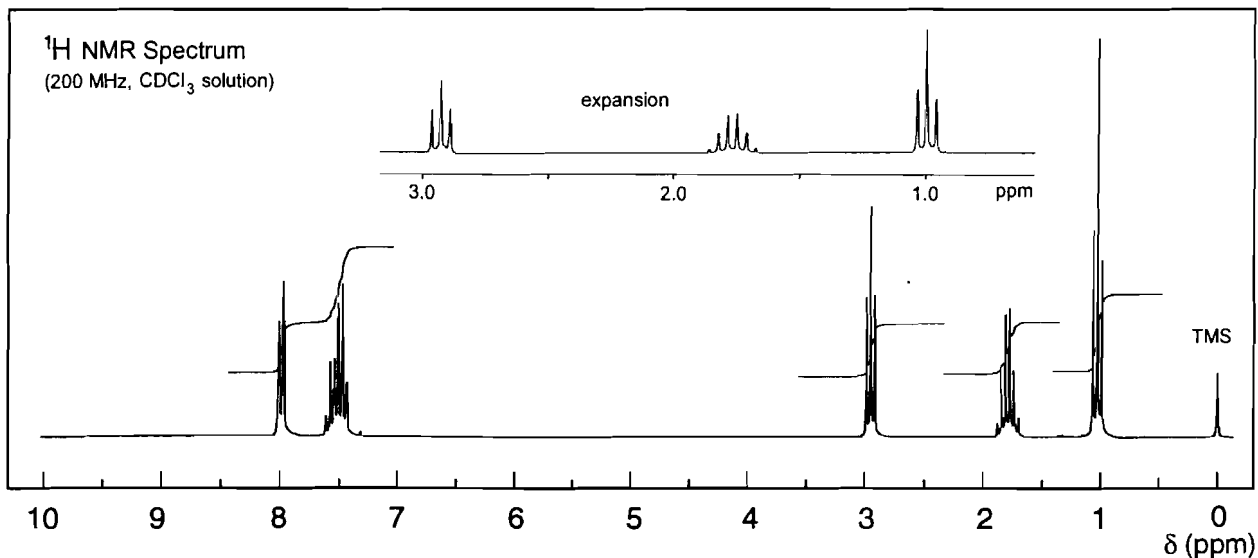
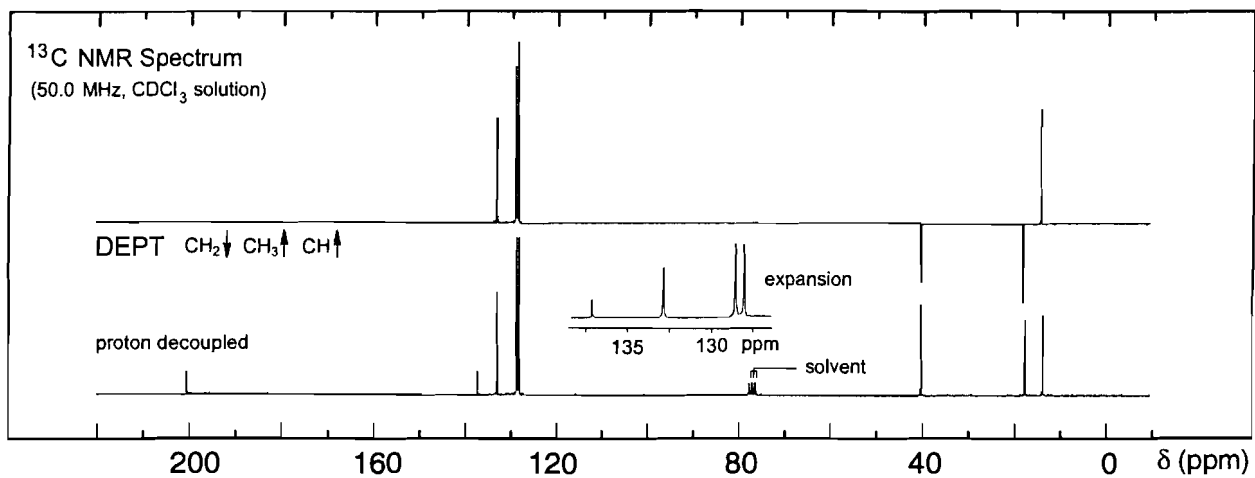

## Problem 33

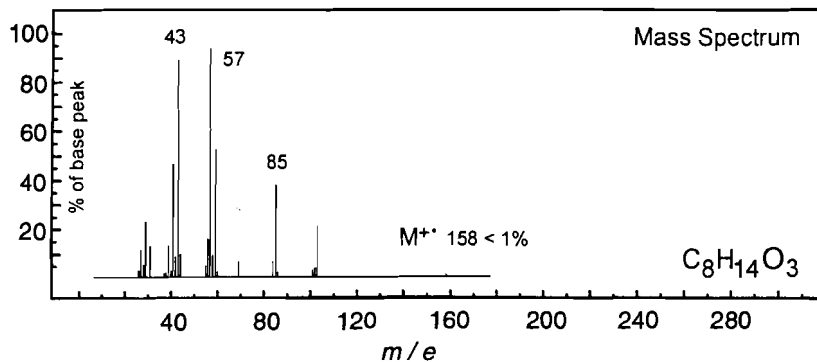
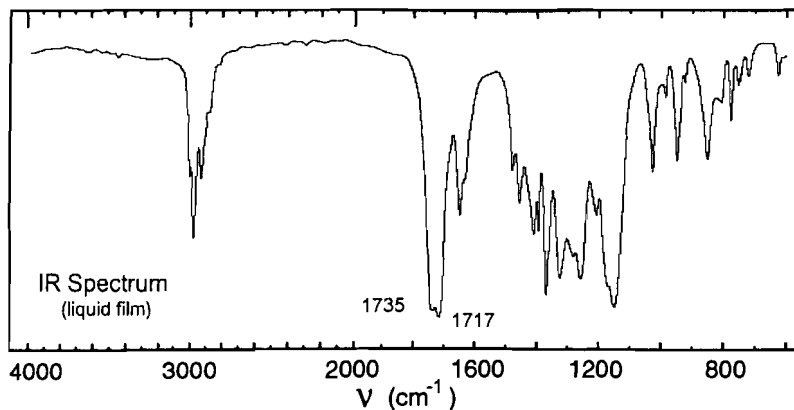

No significant UV  
absorption above 220 nm

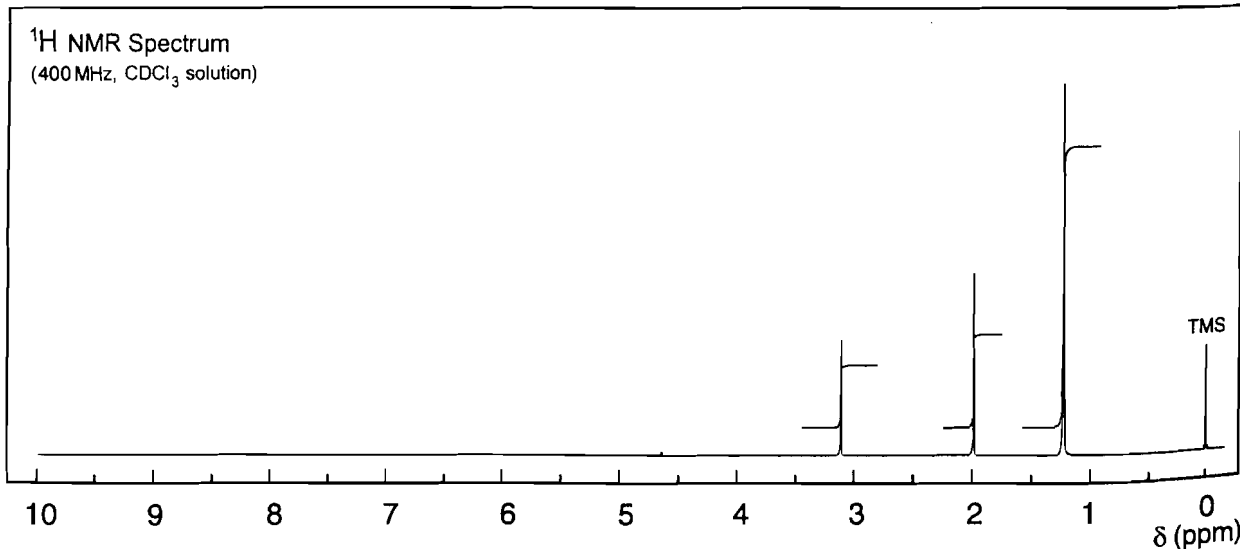
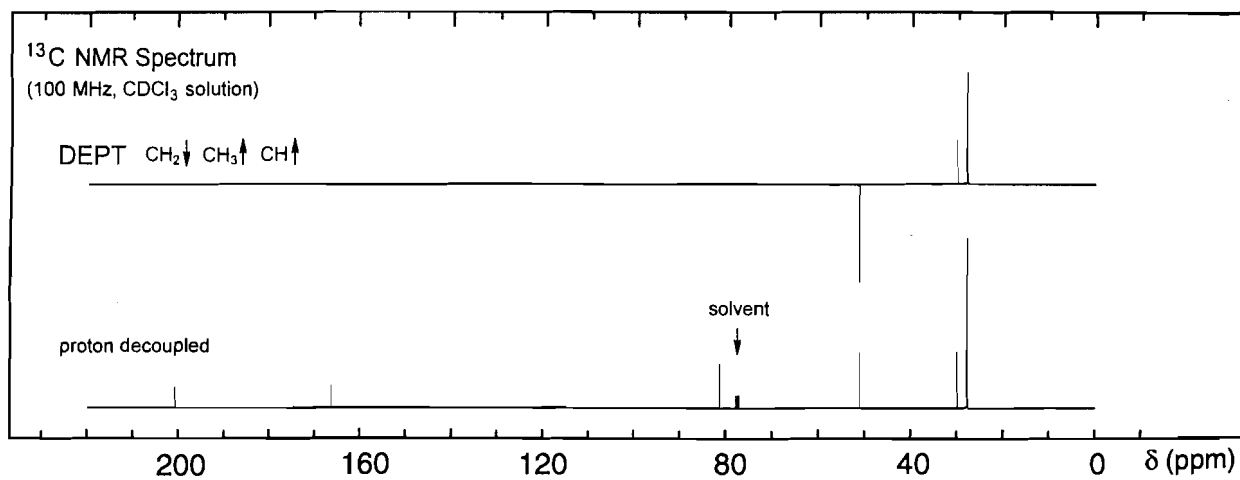

# Problem 34

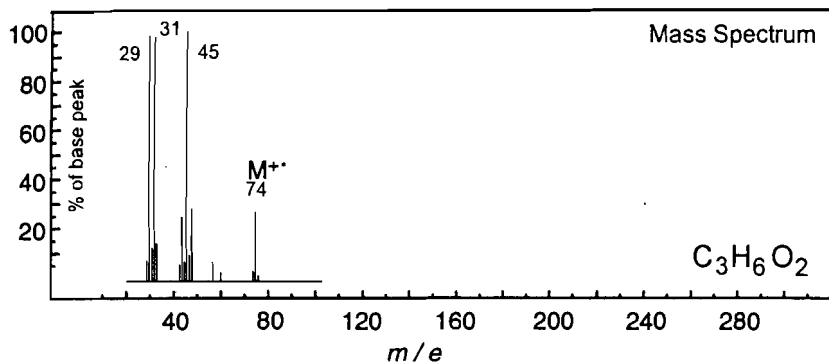
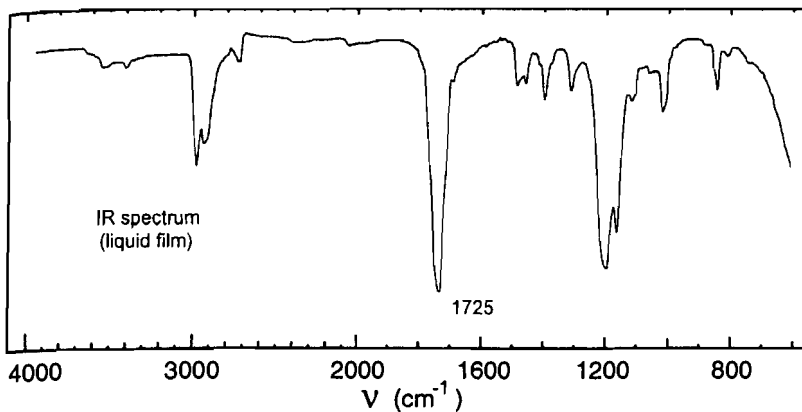

No significant UV  
absorption above 210 nm

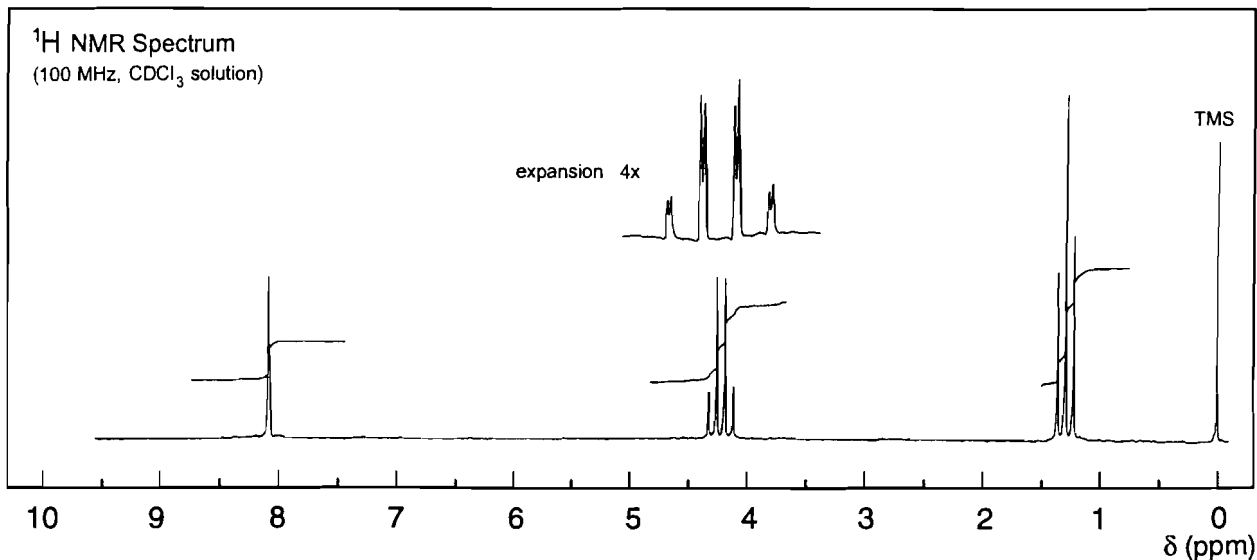
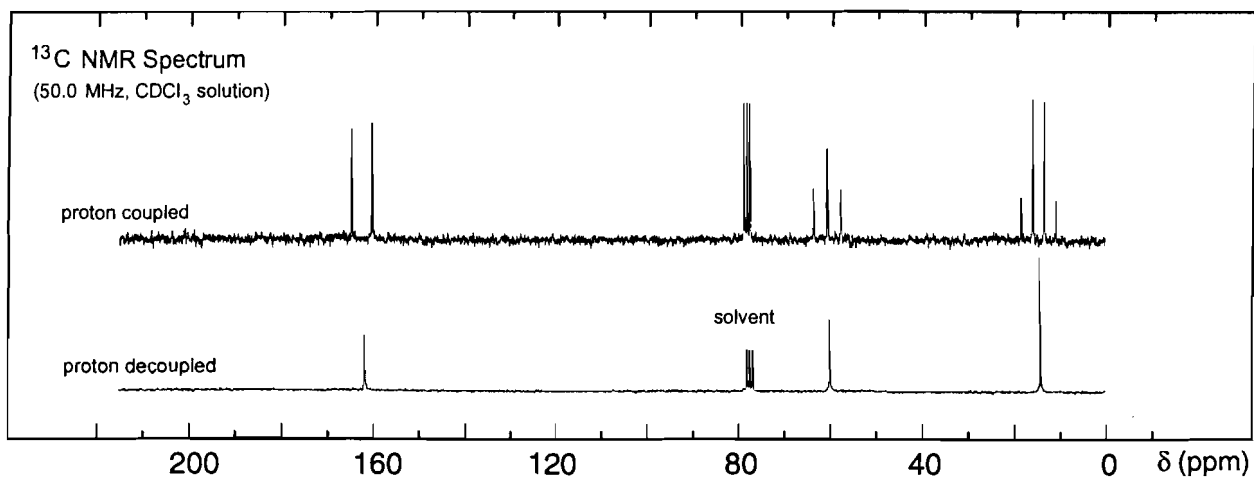

## Problem 35

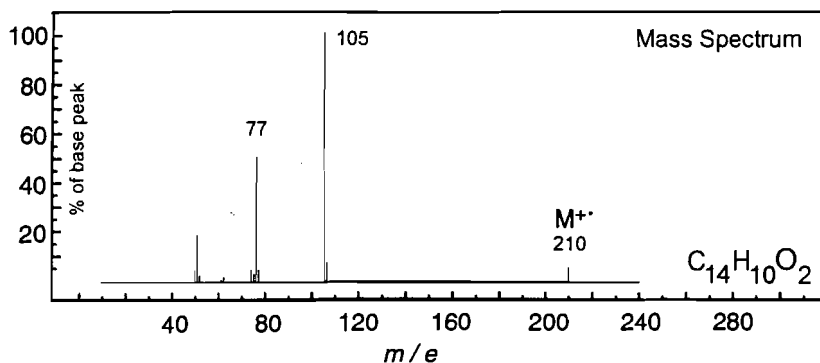
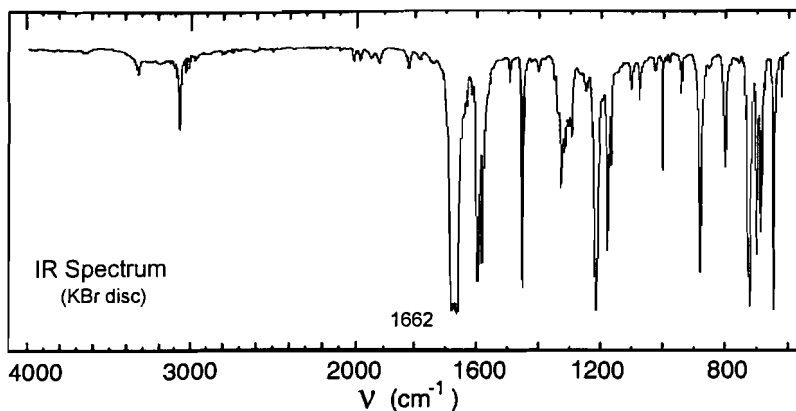

UV Spectrum

 $\lambda_{\max}$  258 nm ( $\log_{10} \epsilon$  4.2) $\lambda_{\max}$  330 nm ( $\log_{10} \epsilon$  2.8) $\lambda_{\max}$  388 nm ( $\log_{10} \epsilon$  2.2)

solvent: ethanol

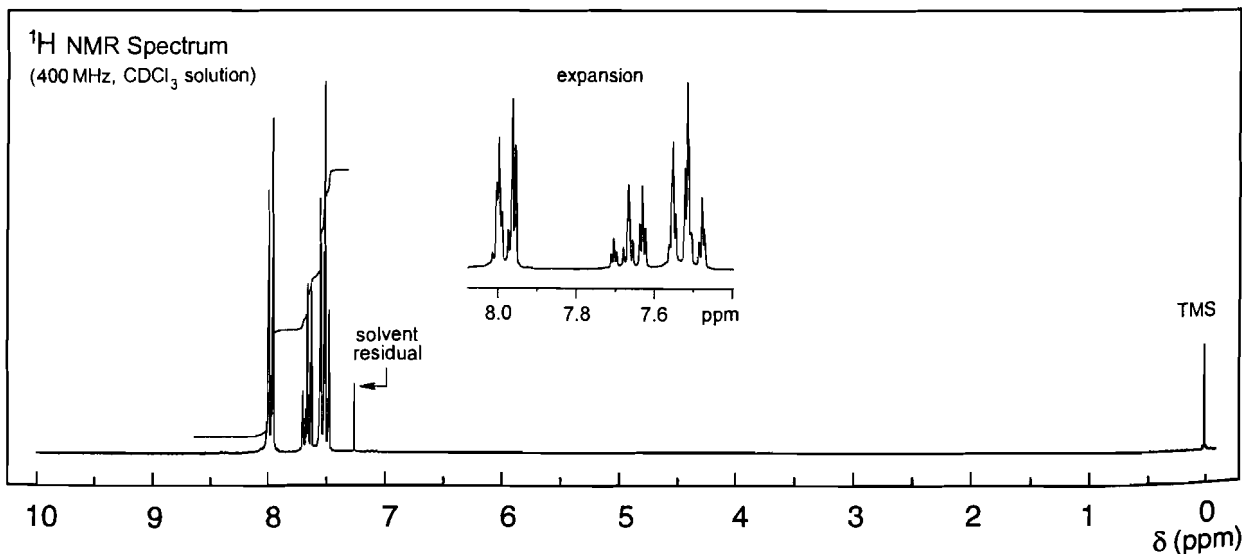
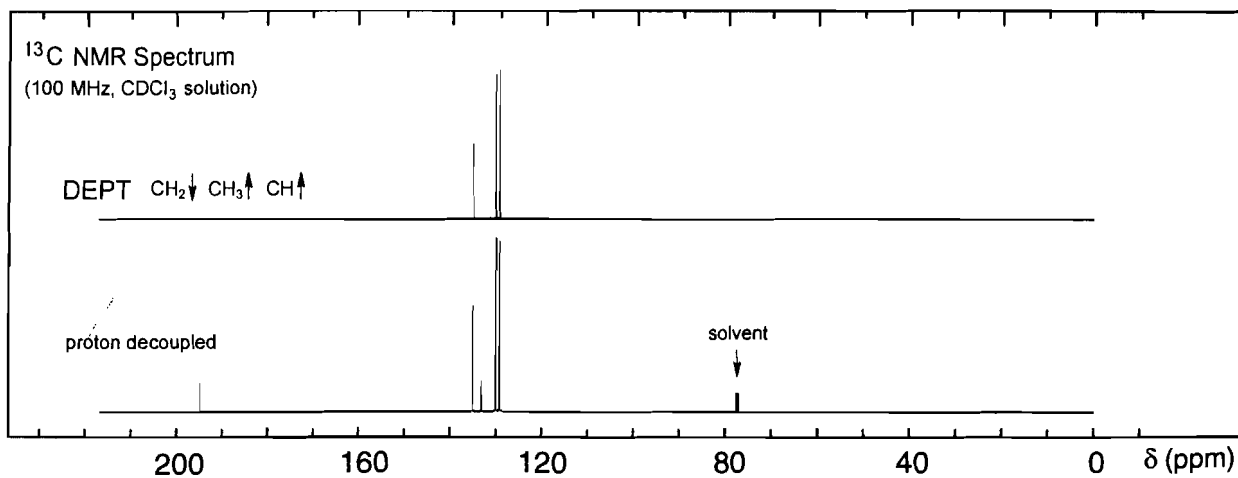

## Problem 36

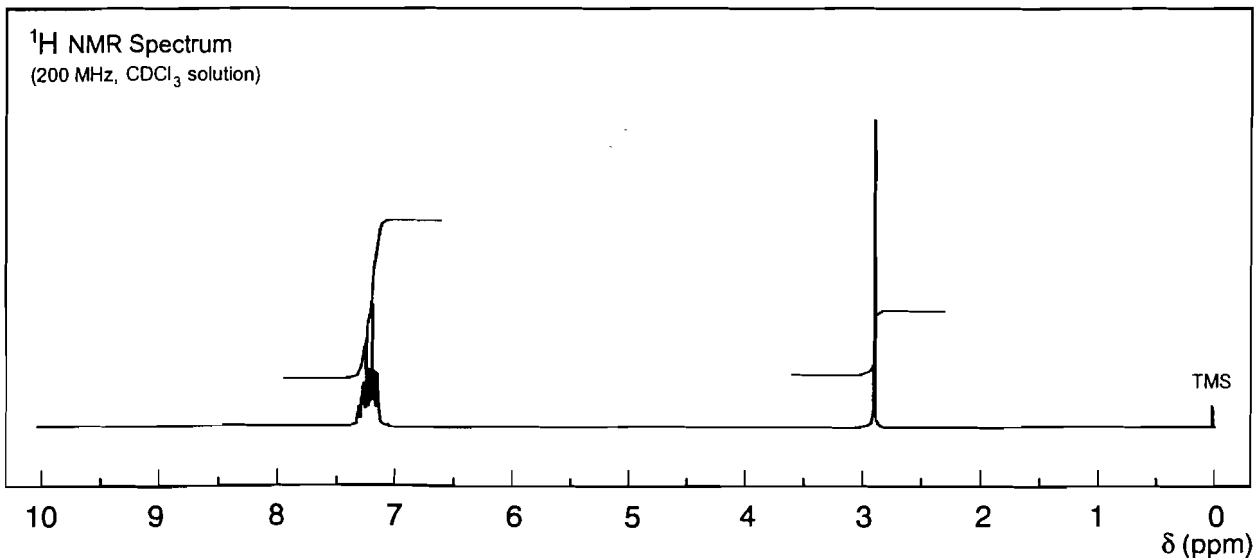
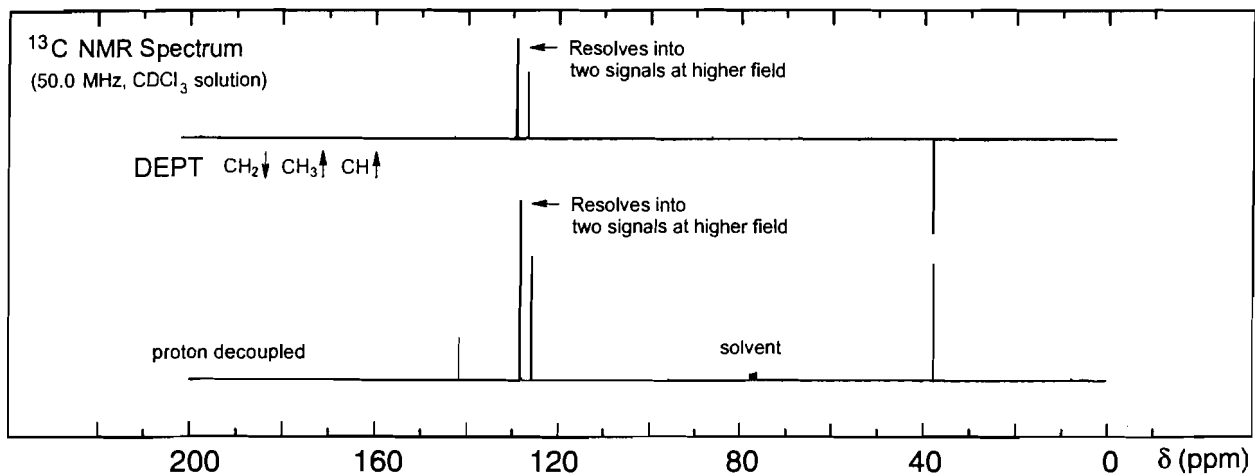
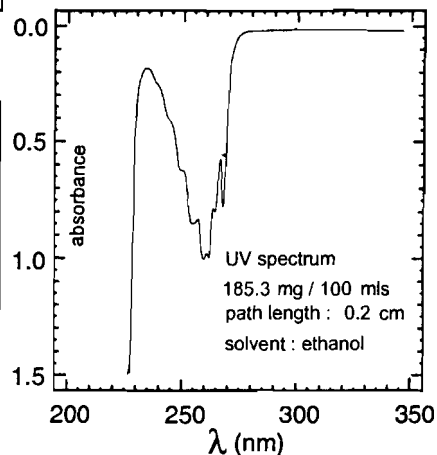
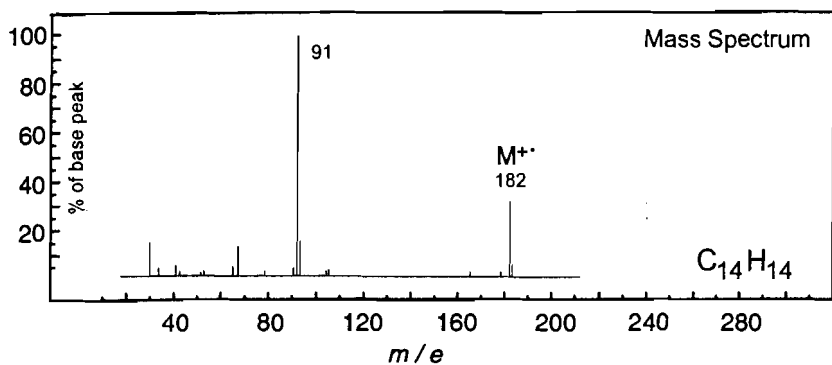
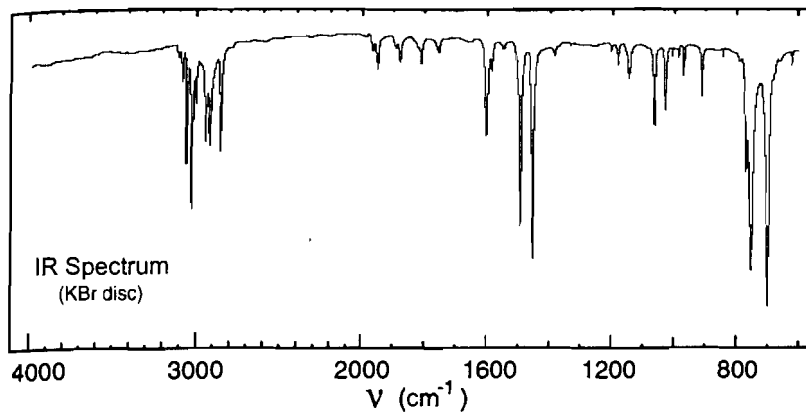

## Problem 37

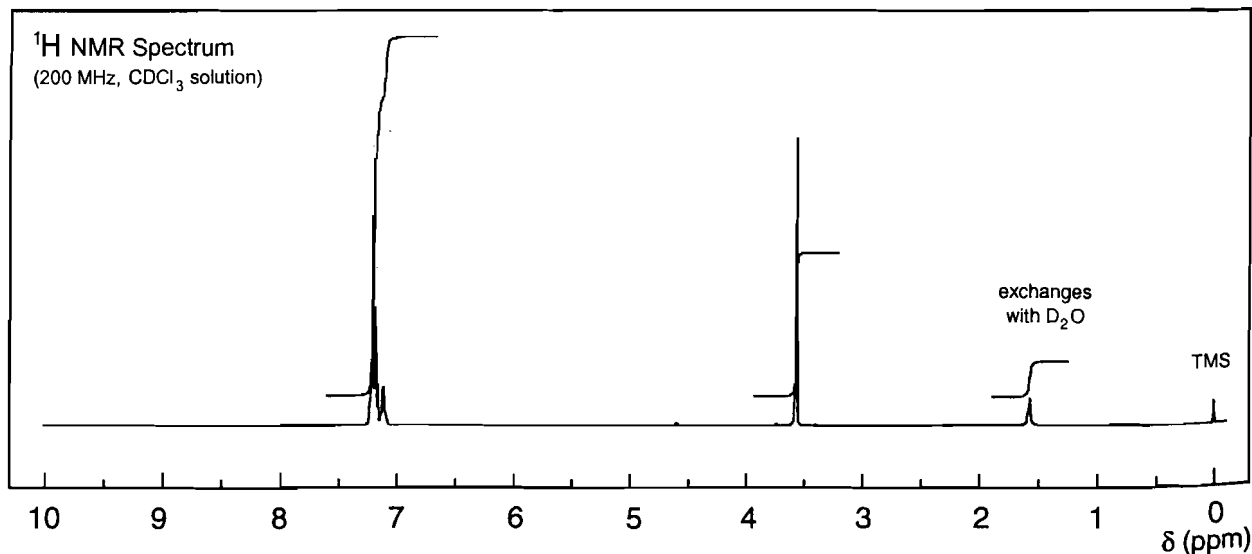
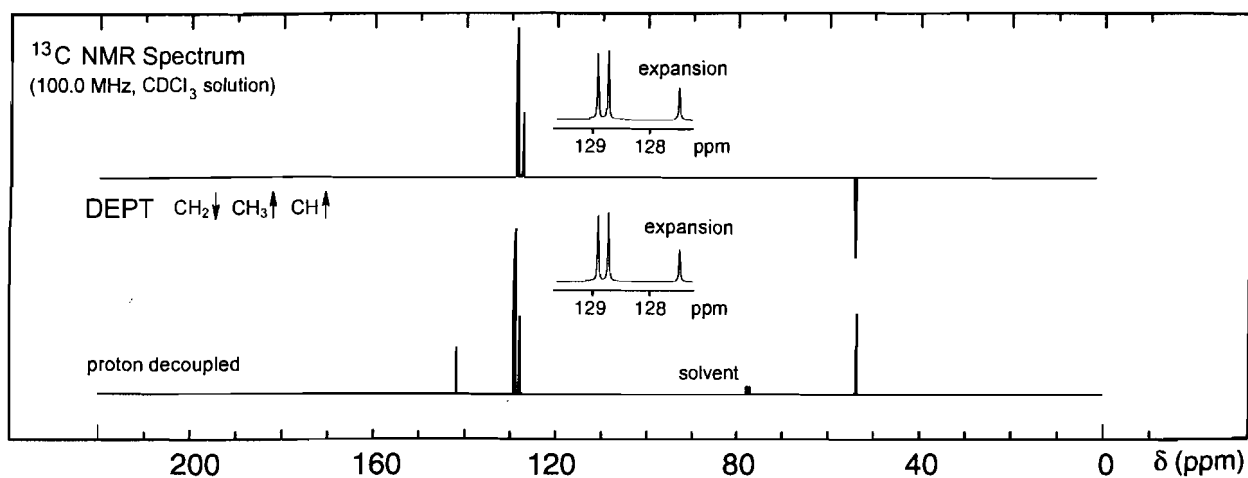
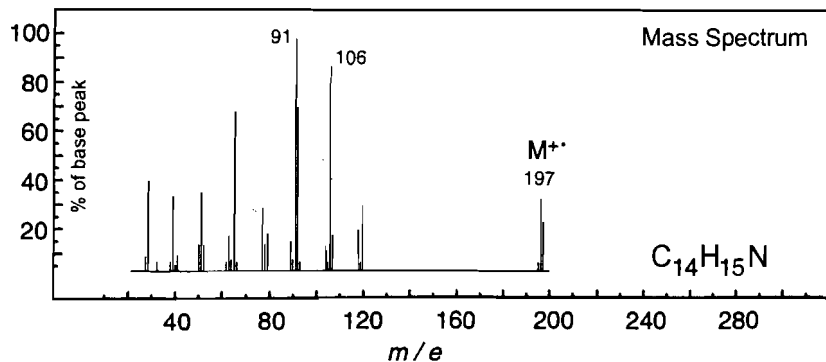
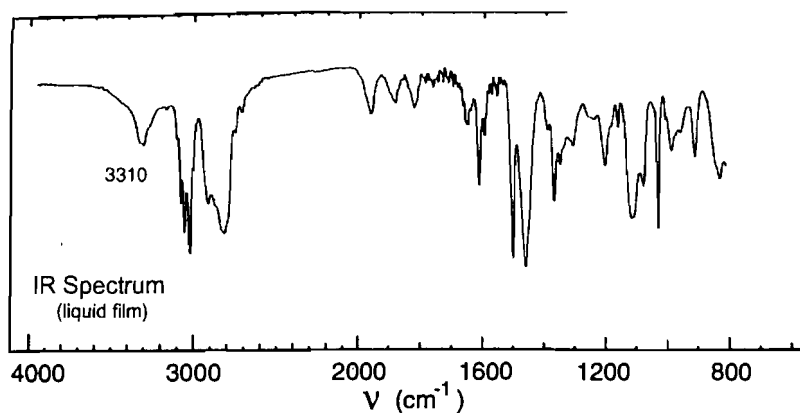

## Problem 38

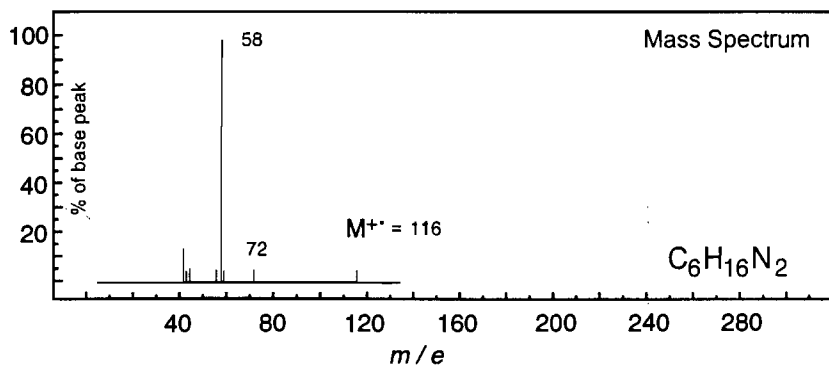
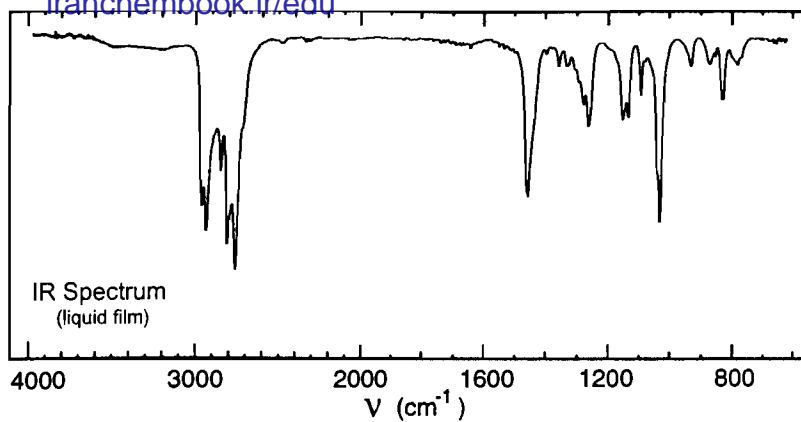

No significant UV  
absorption above 220 nm

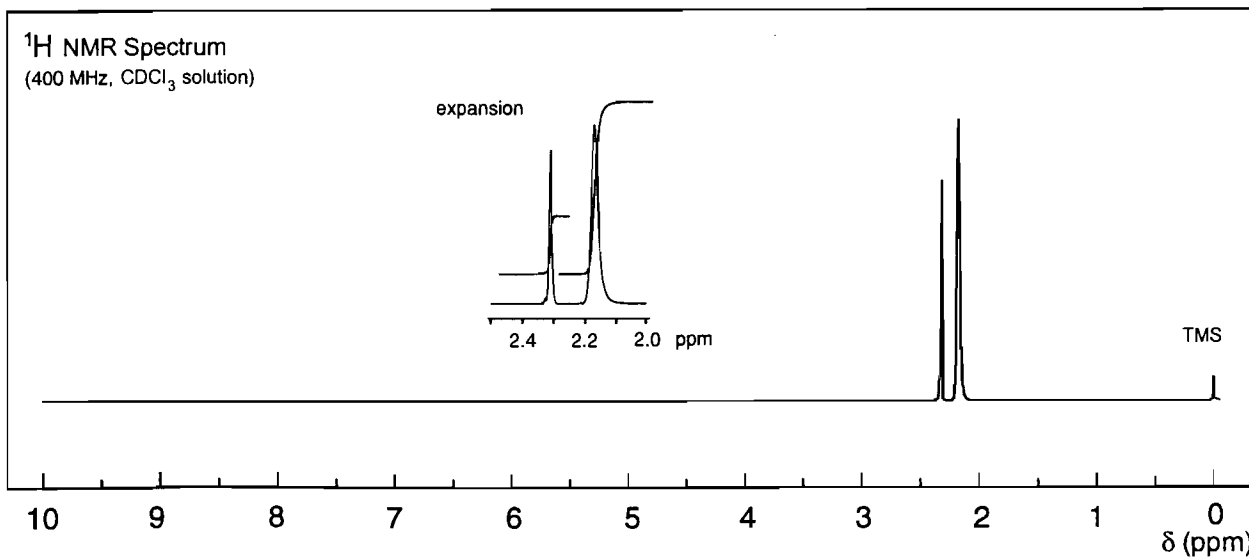
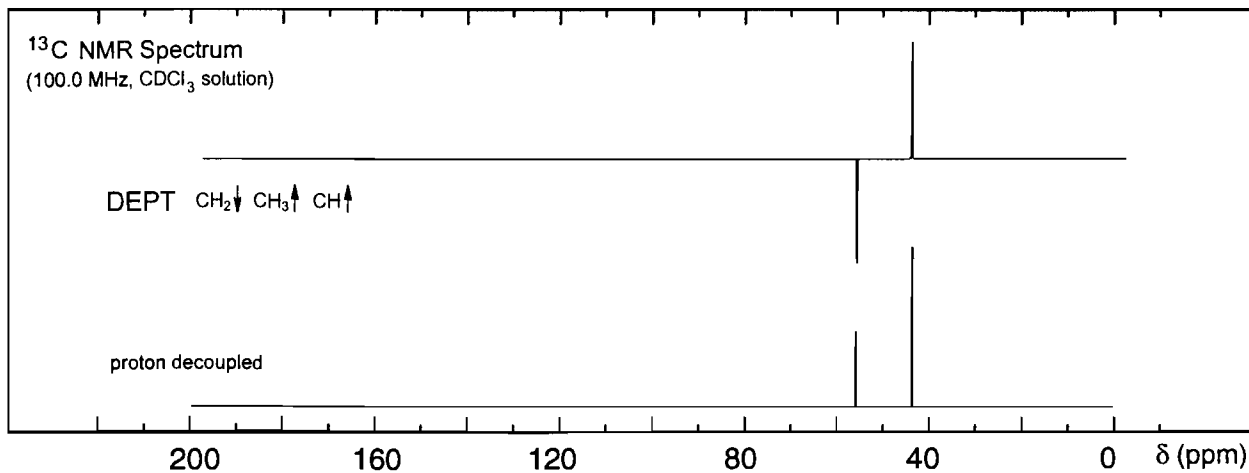



## Problem 39

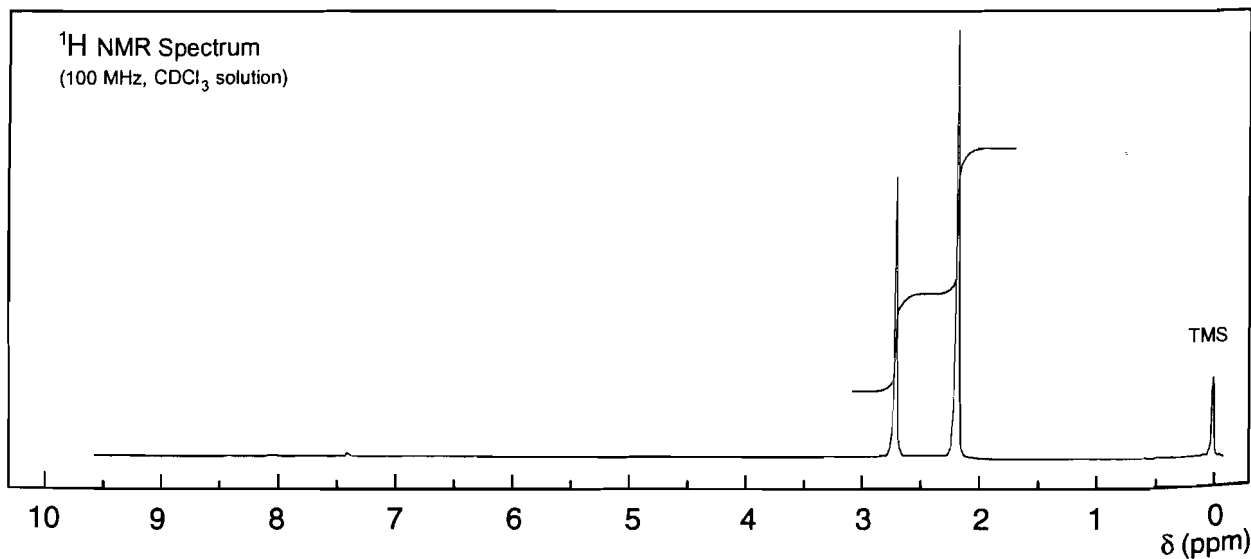
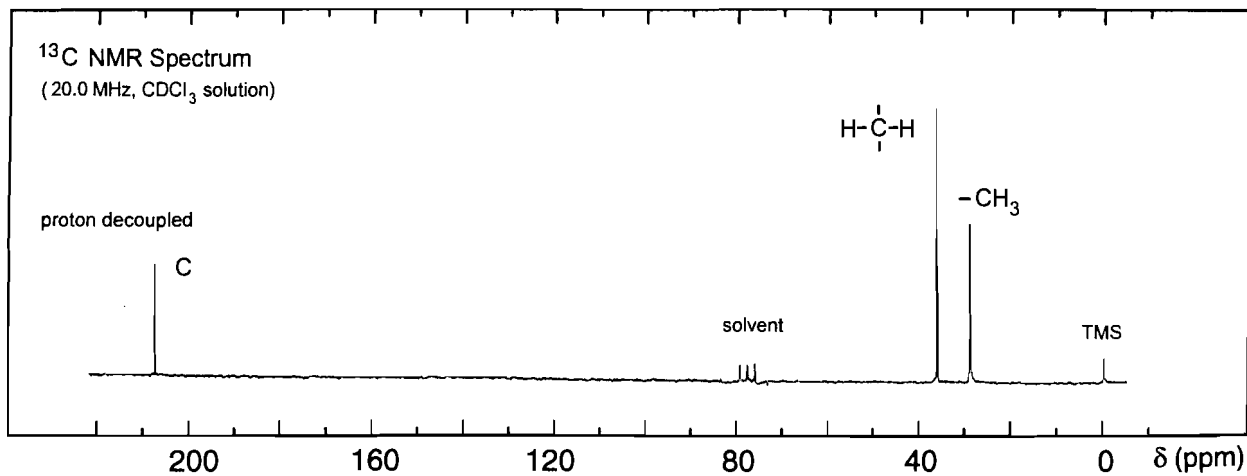
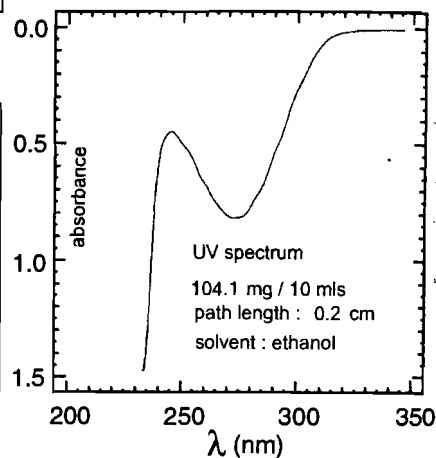
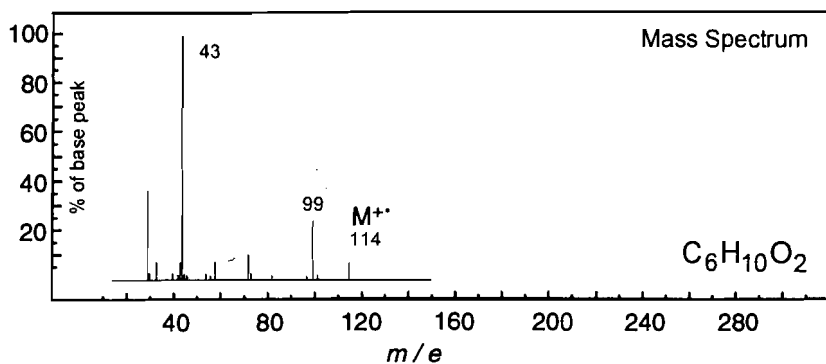
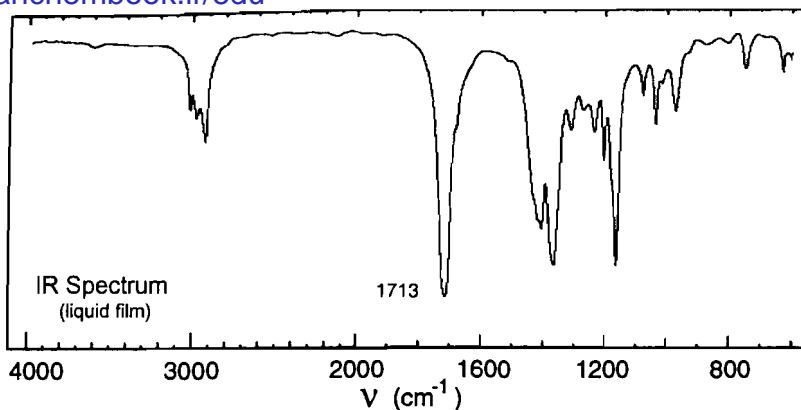

## Problem 40

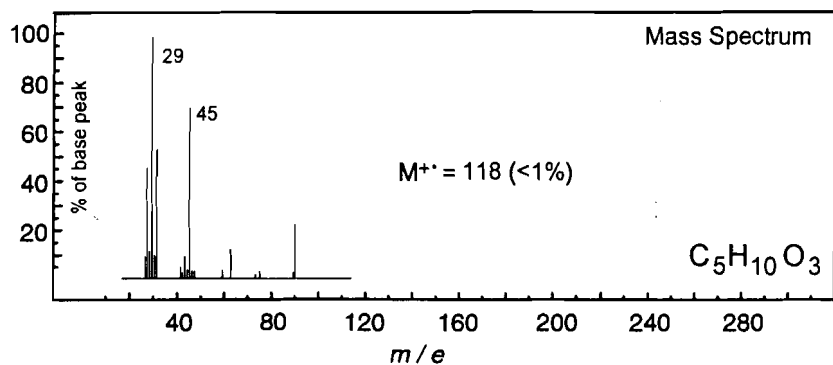
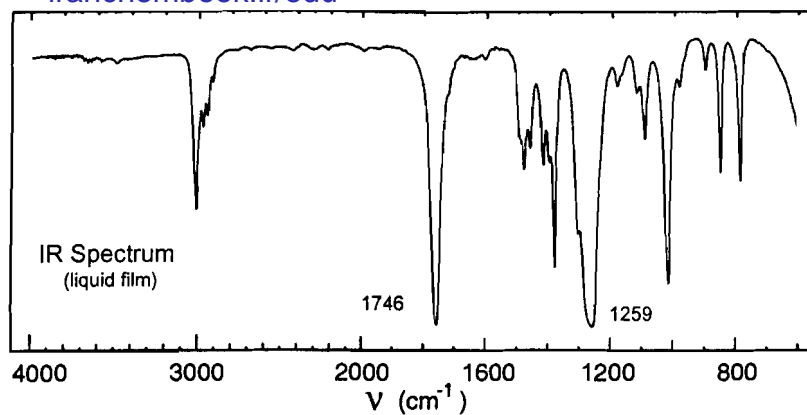

No significant UV  
absorption above 220 nm

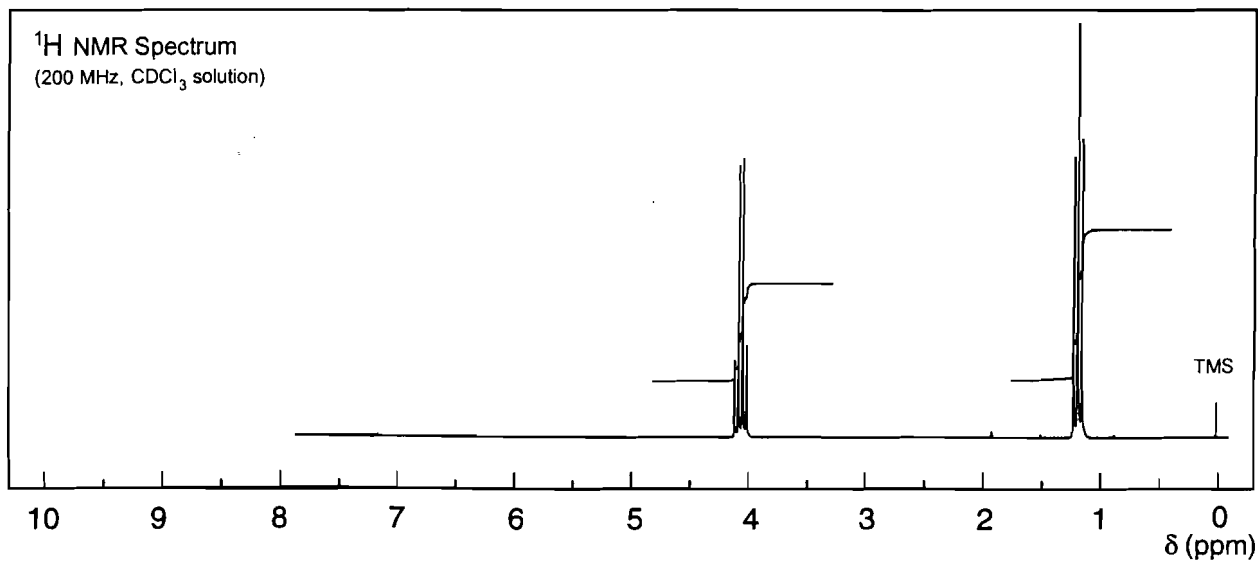
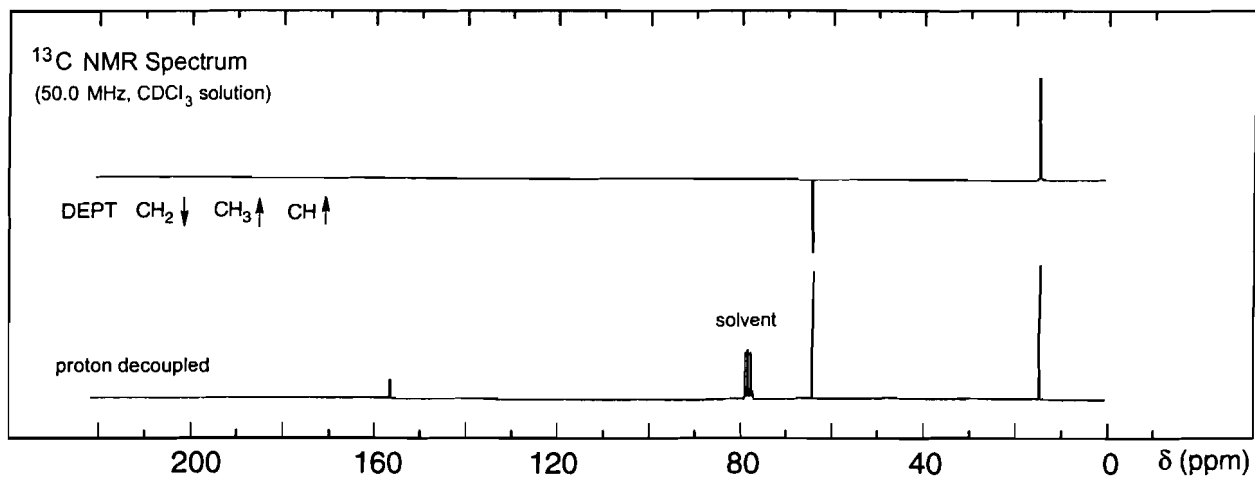

## Problem 41

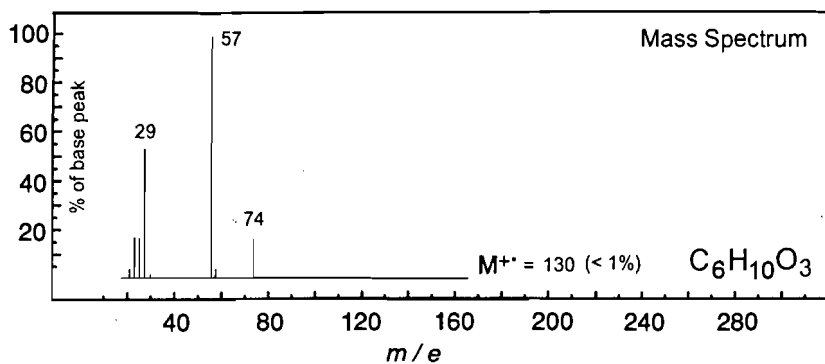
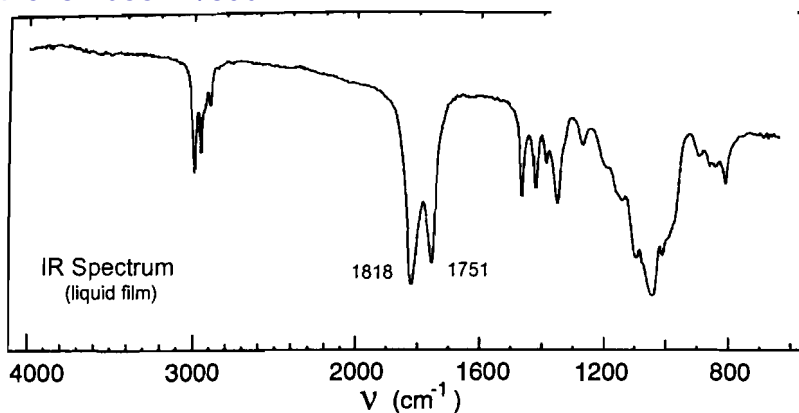

No significant UV  
absorption above 220 nm

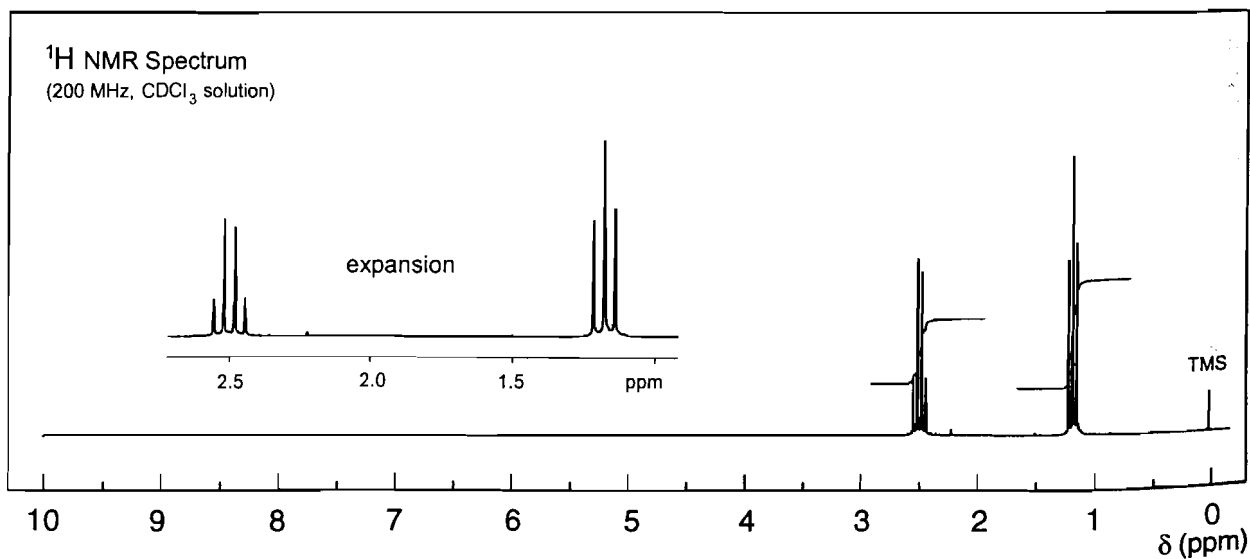
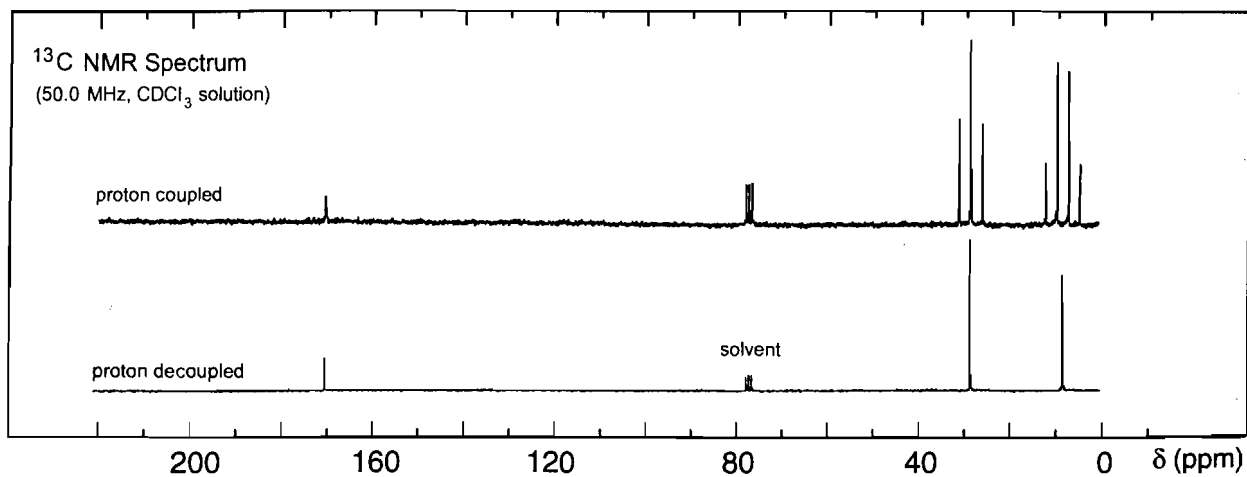

## Problem 42

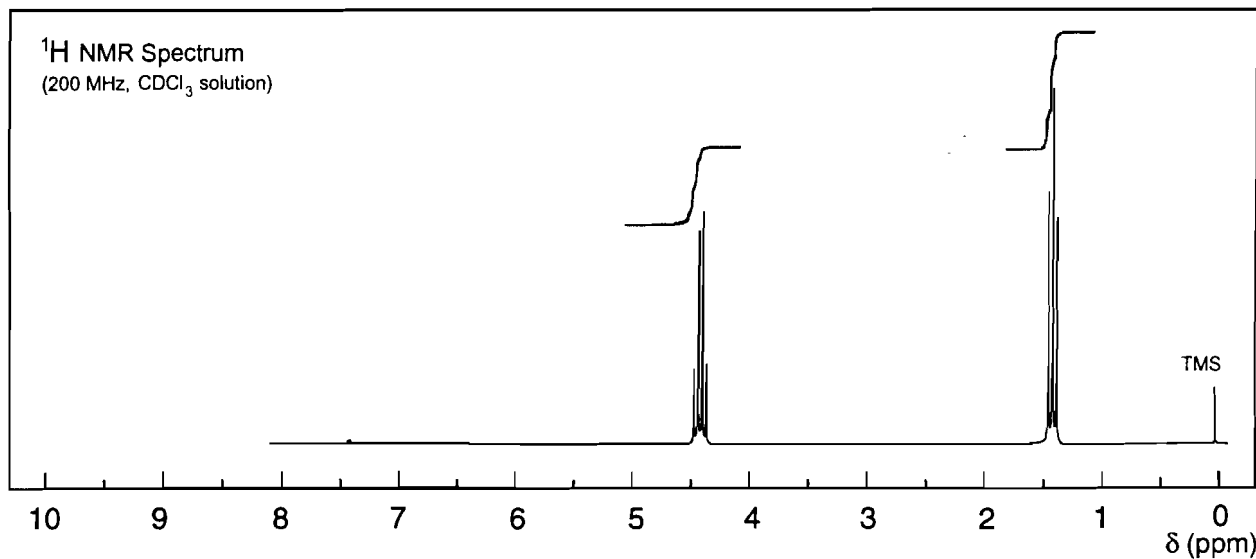
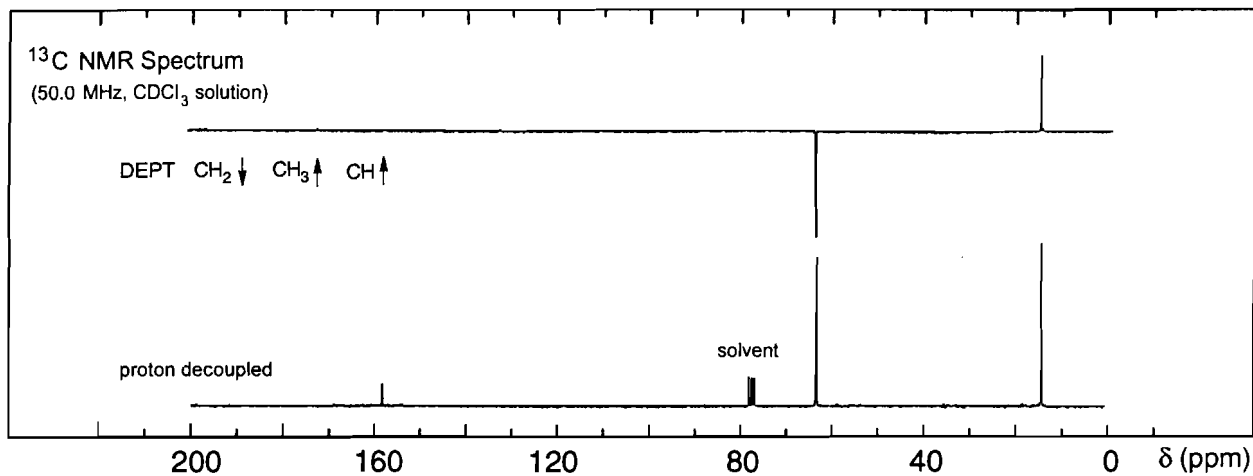
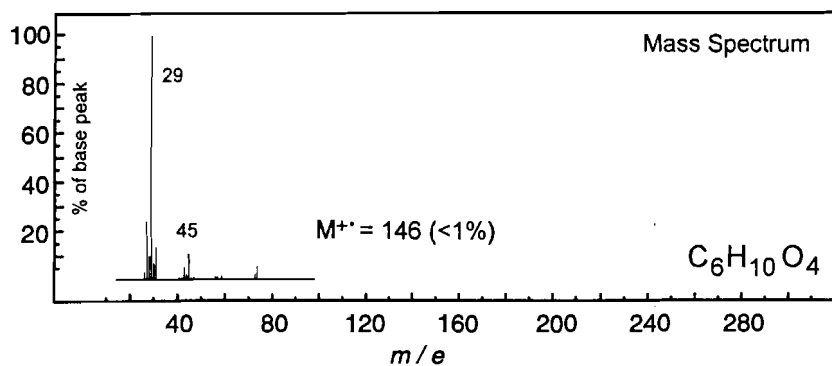
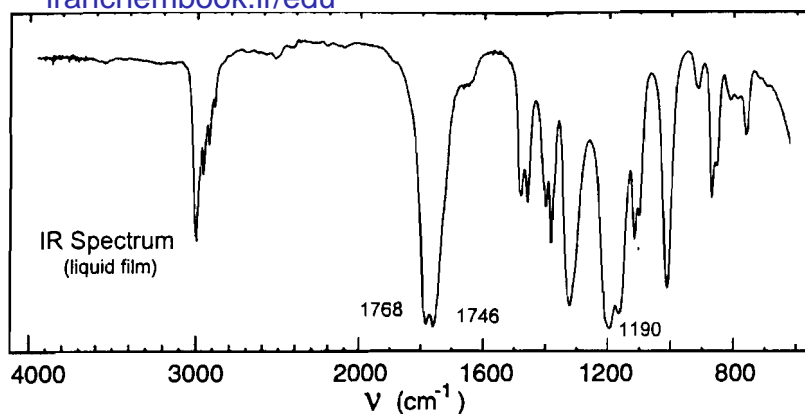

## Problem 43

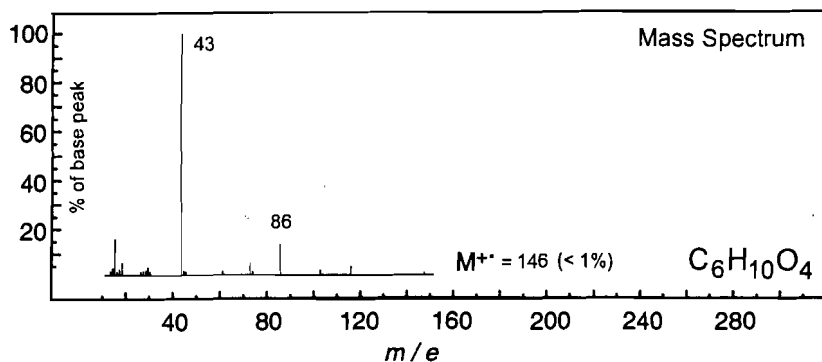
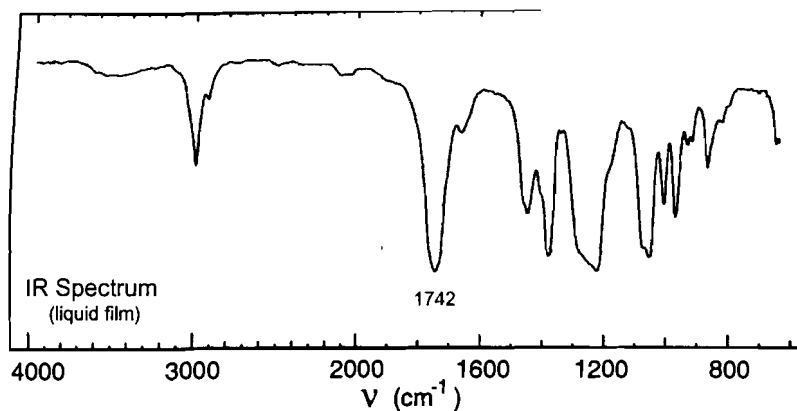

No significant UV  
absorption above 220 nm

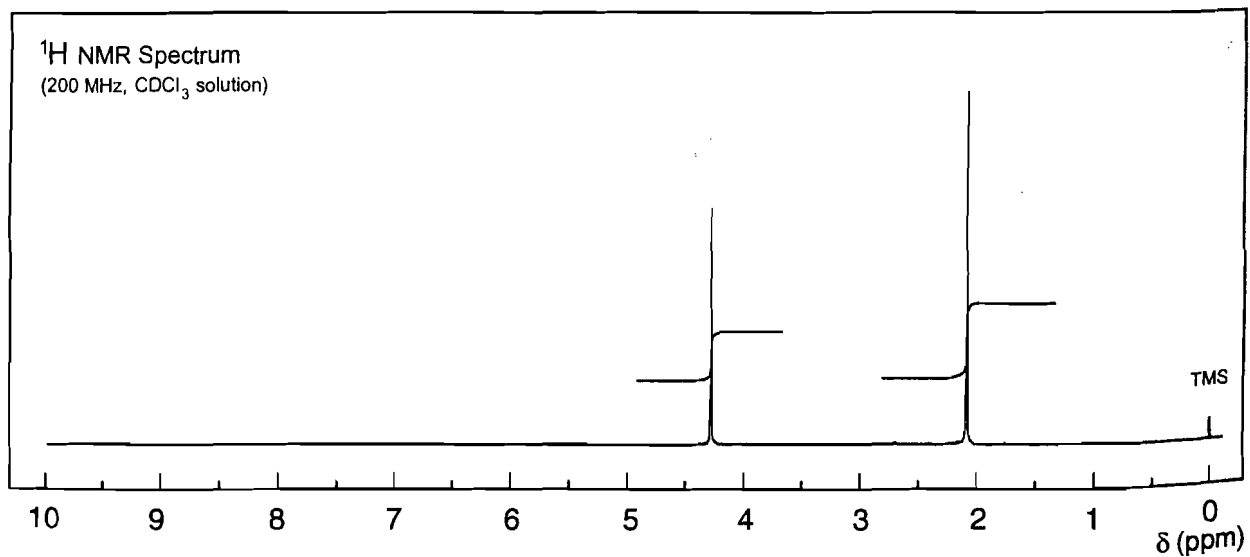
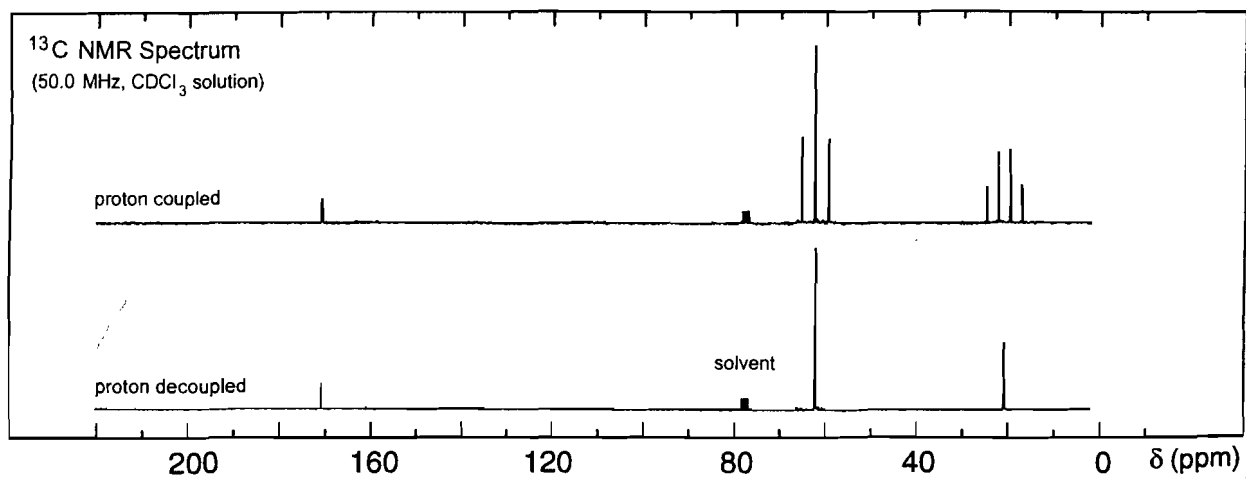

# Problem 44

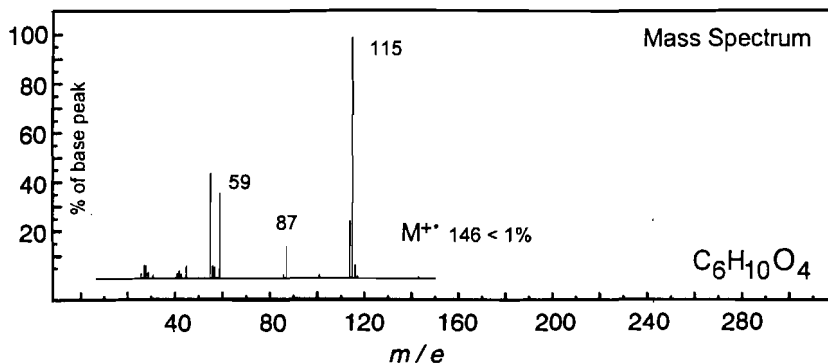
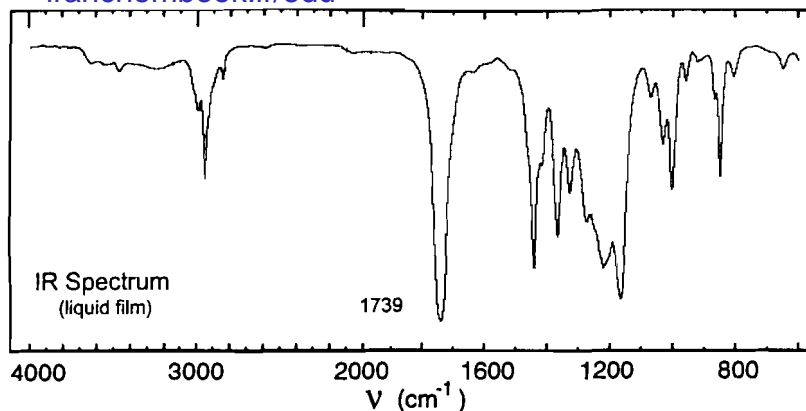

No significant UV  
absorption above 220 nm

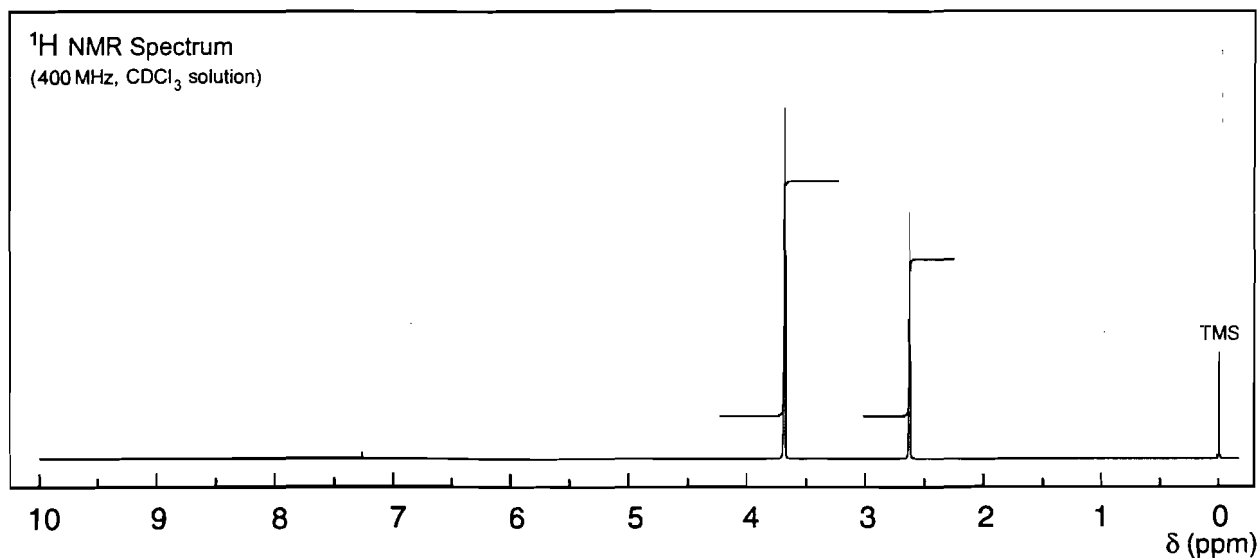
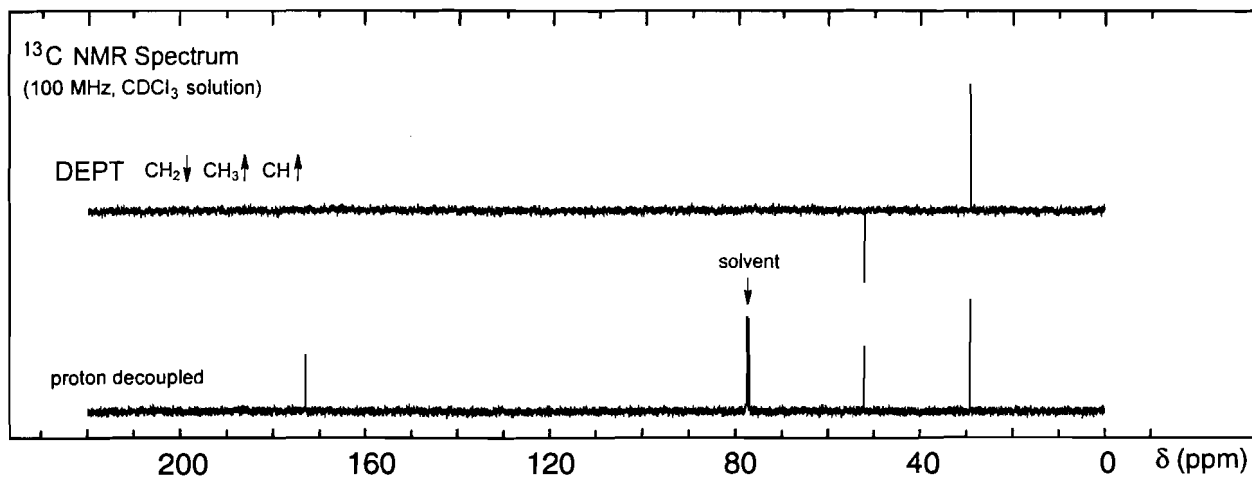

## Problem 45

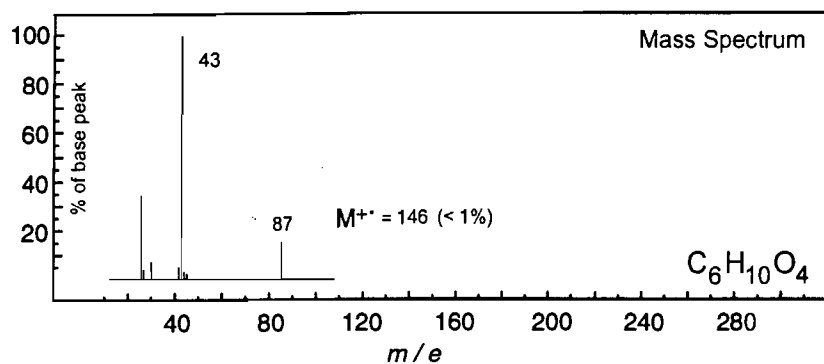
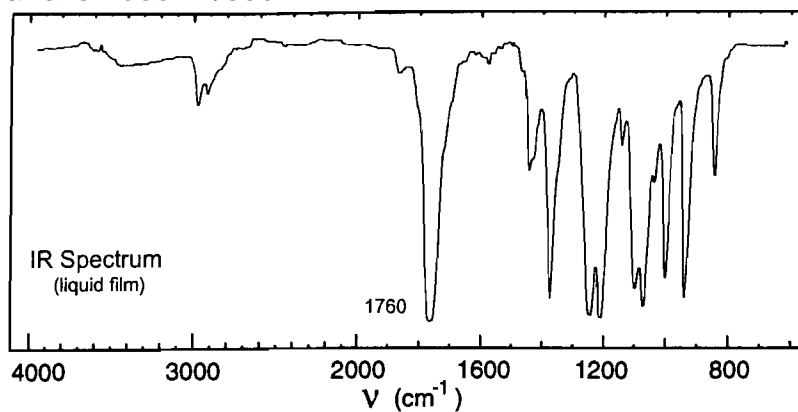

No significant UV  
absorption above 220 nm

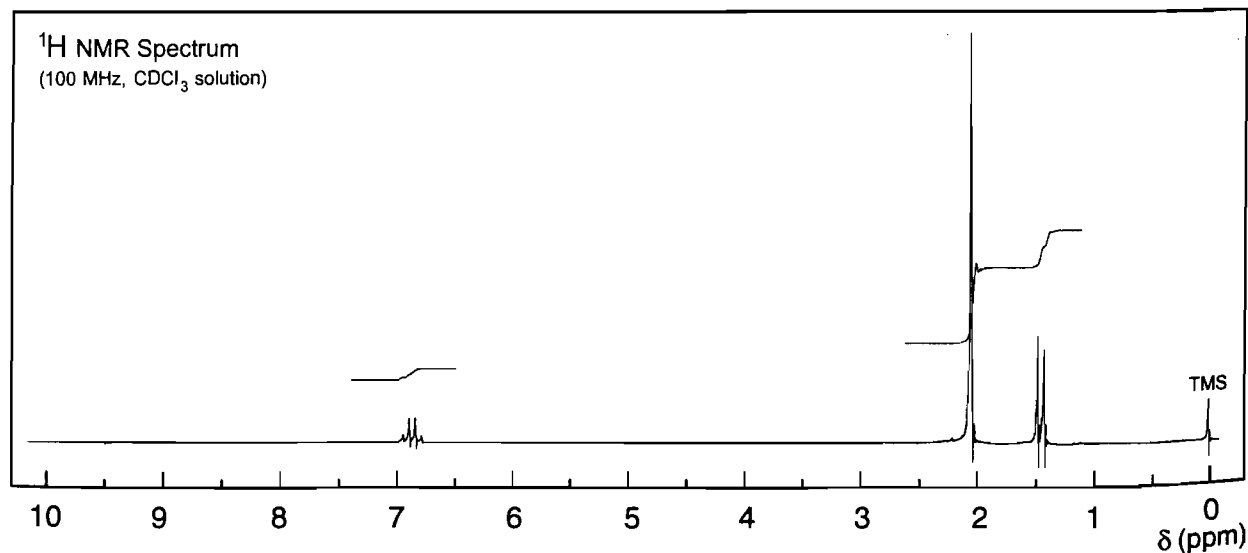
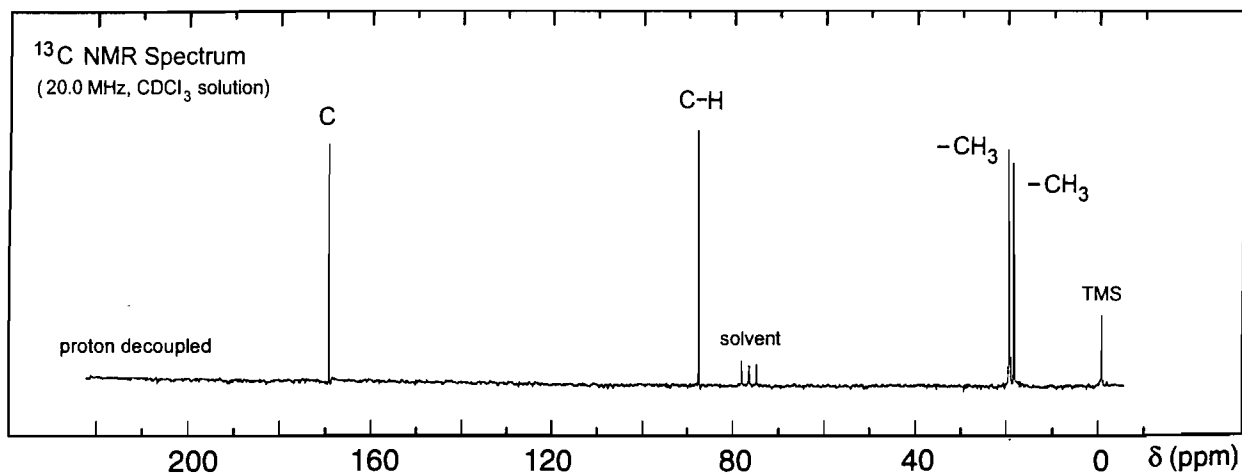

## Problem 46

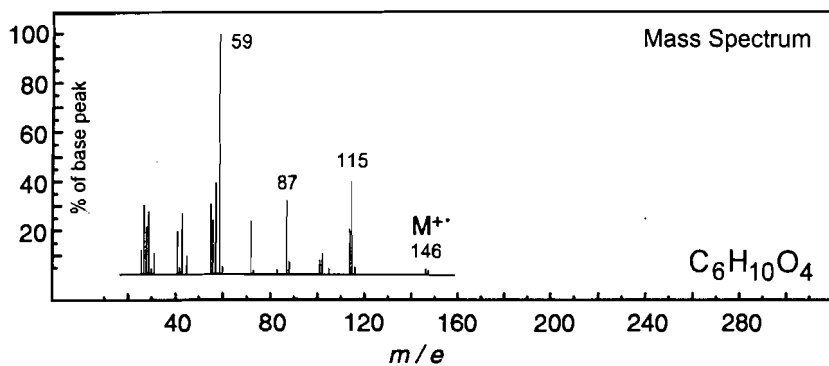
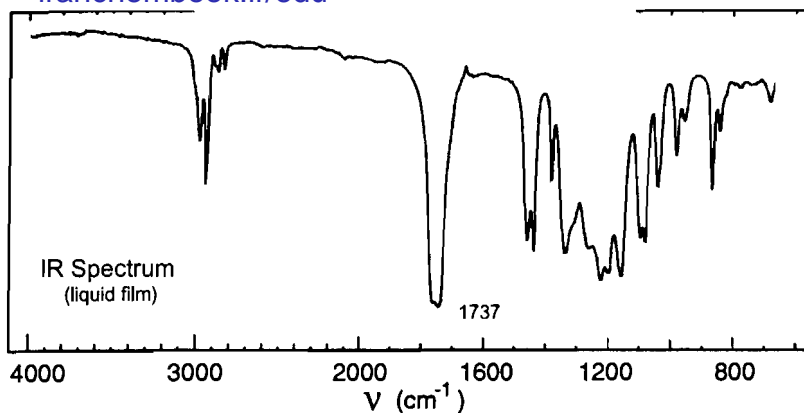

No significant UV  
absorption above 220 nm

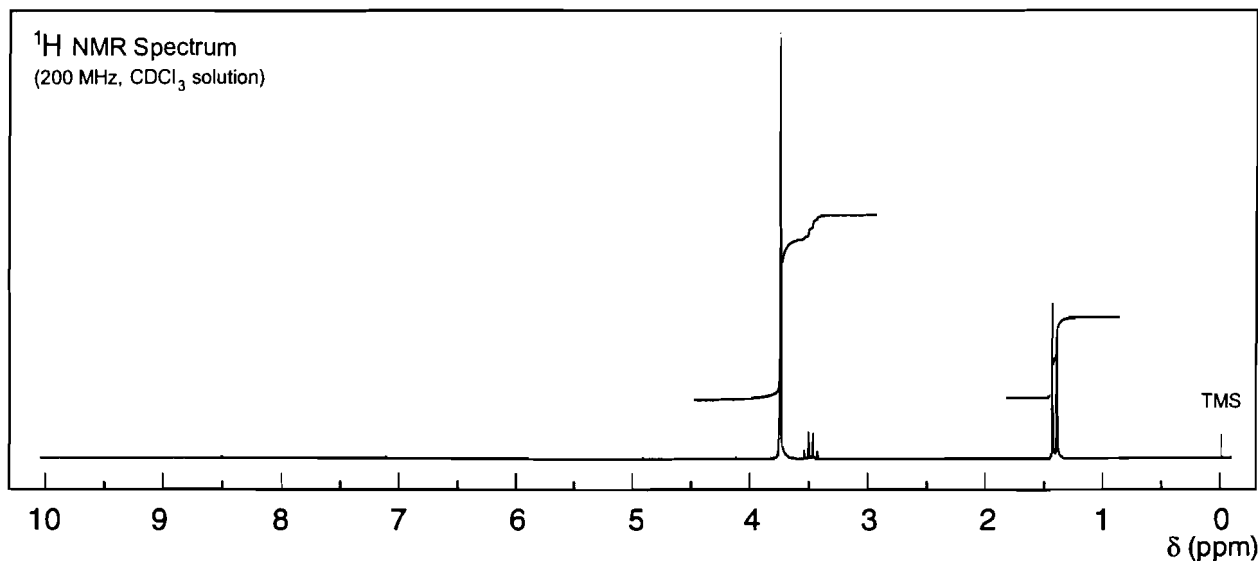
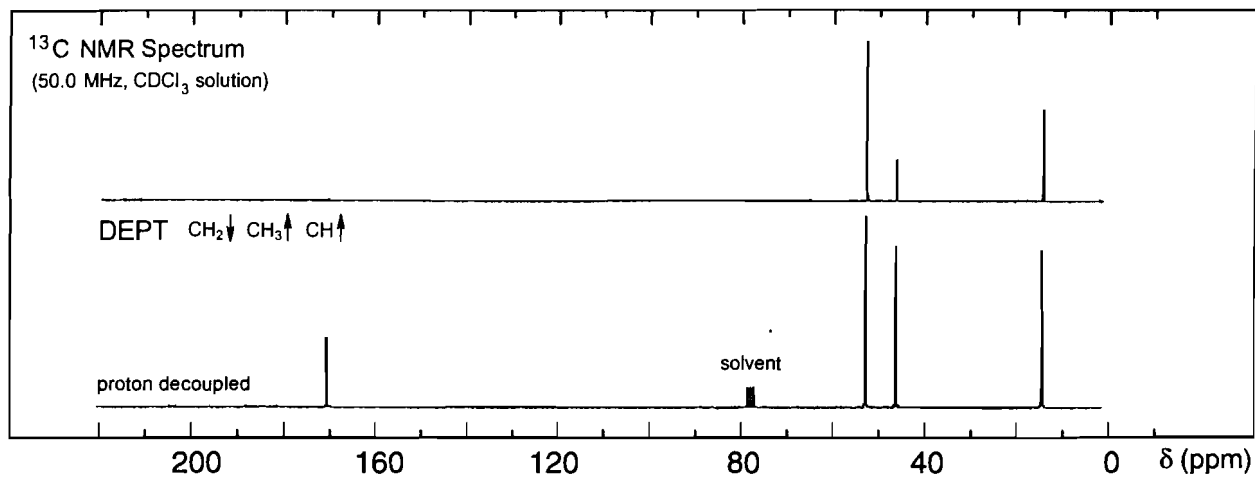



## Problem 47

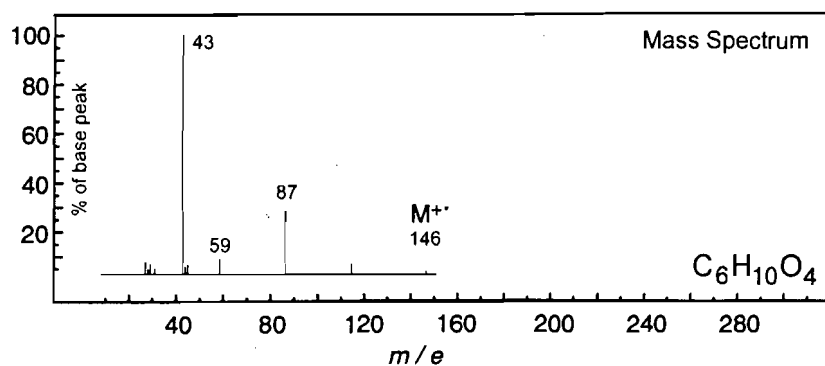
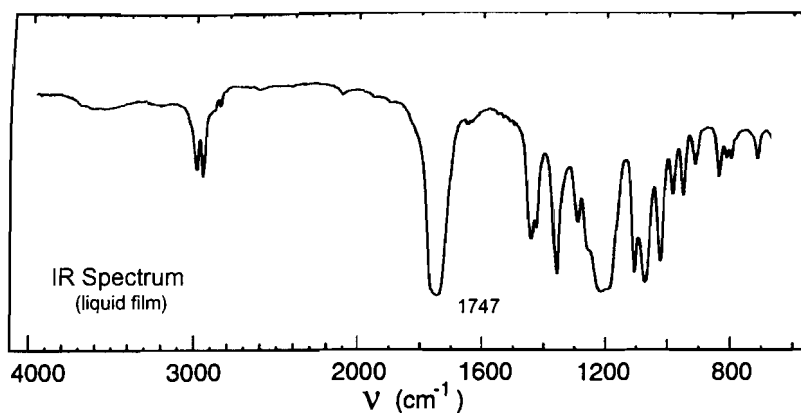

No significant UV  
absorption above 220 nm

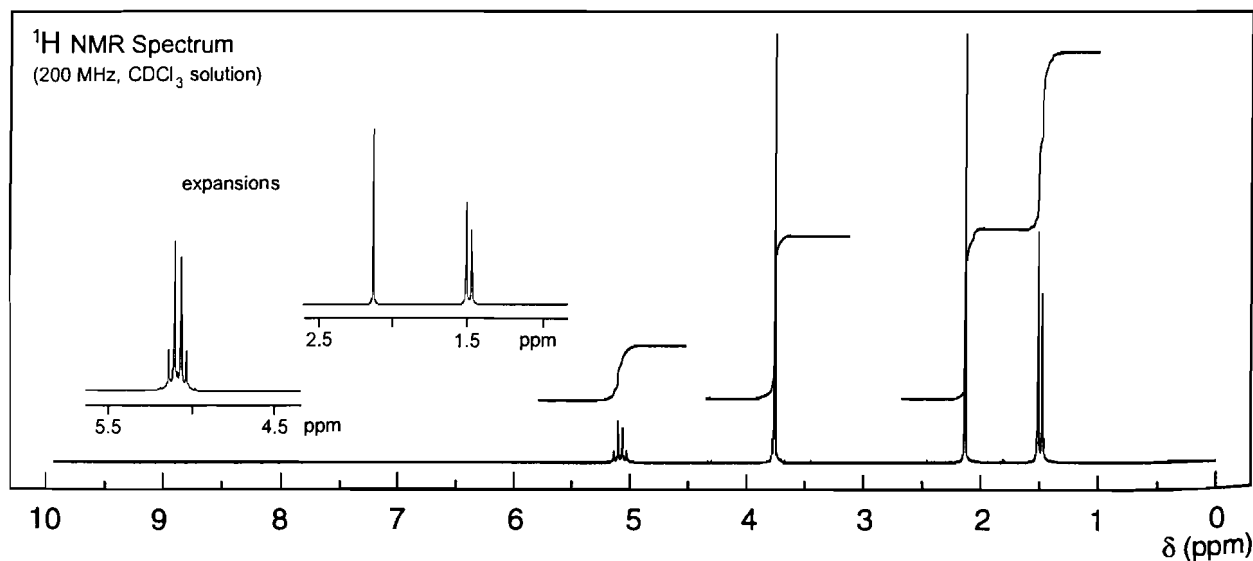
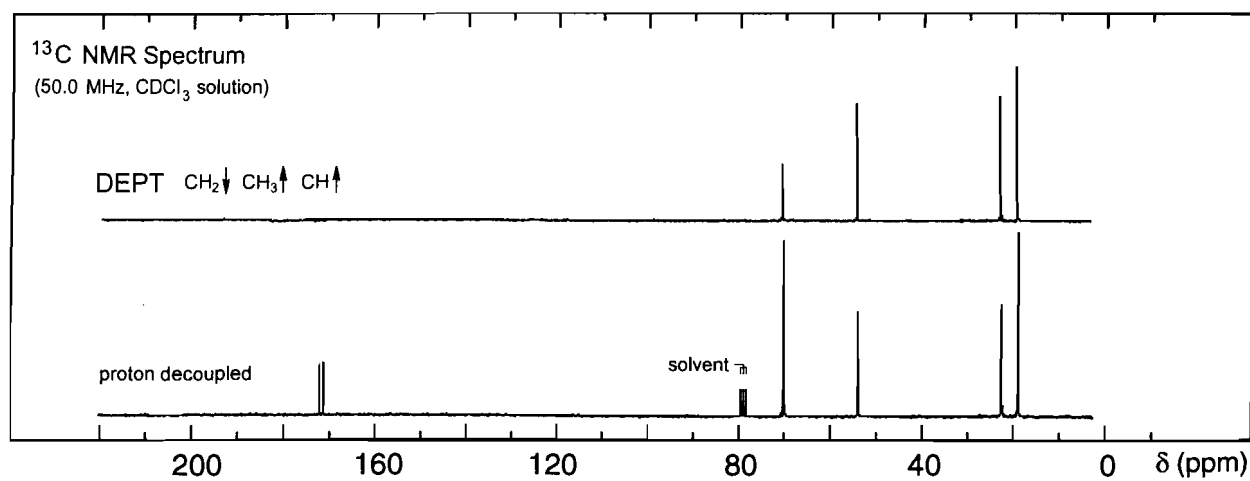

## Problem 48

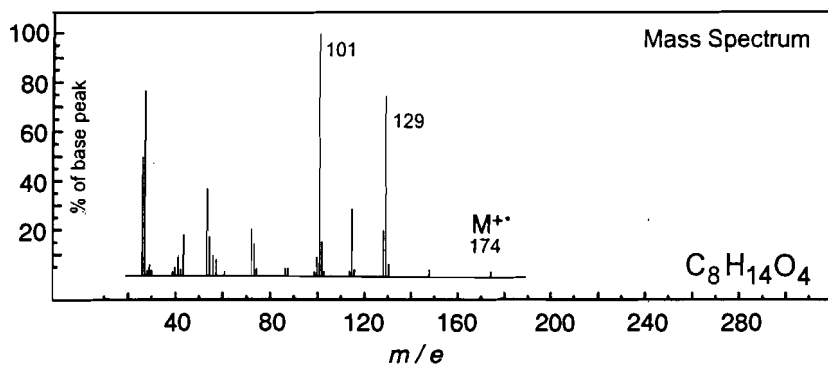
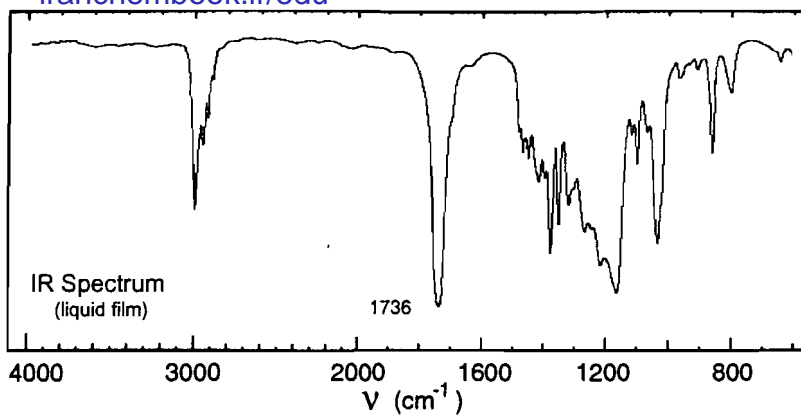

No significant UV  
absorption above 220 nm

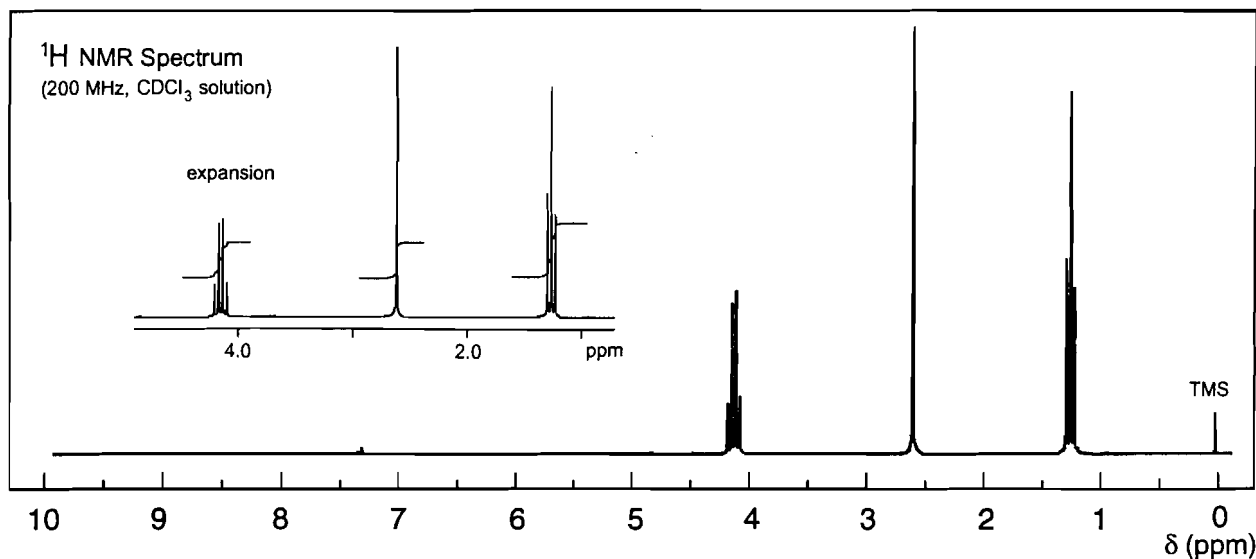
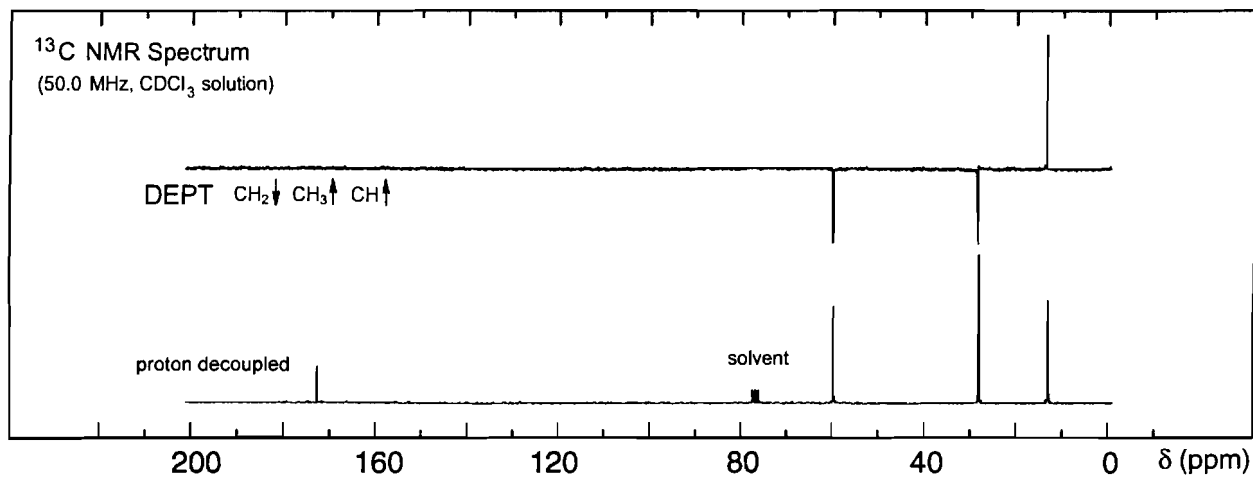

## Problem 49

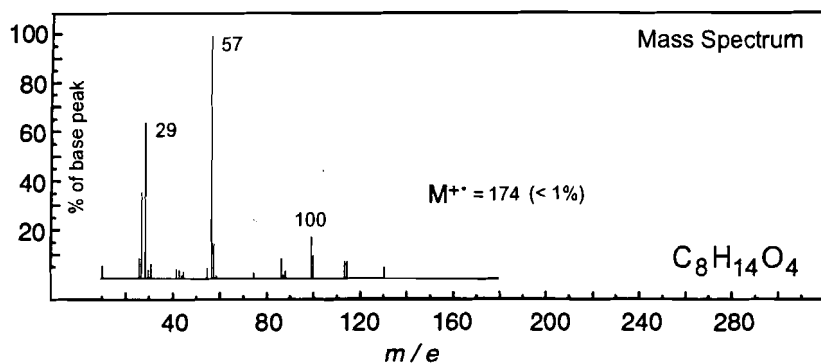
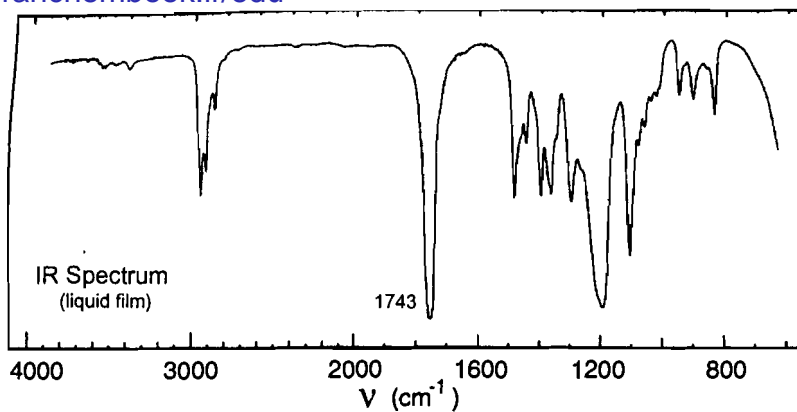

No significant UV  
absorption above 220 nm

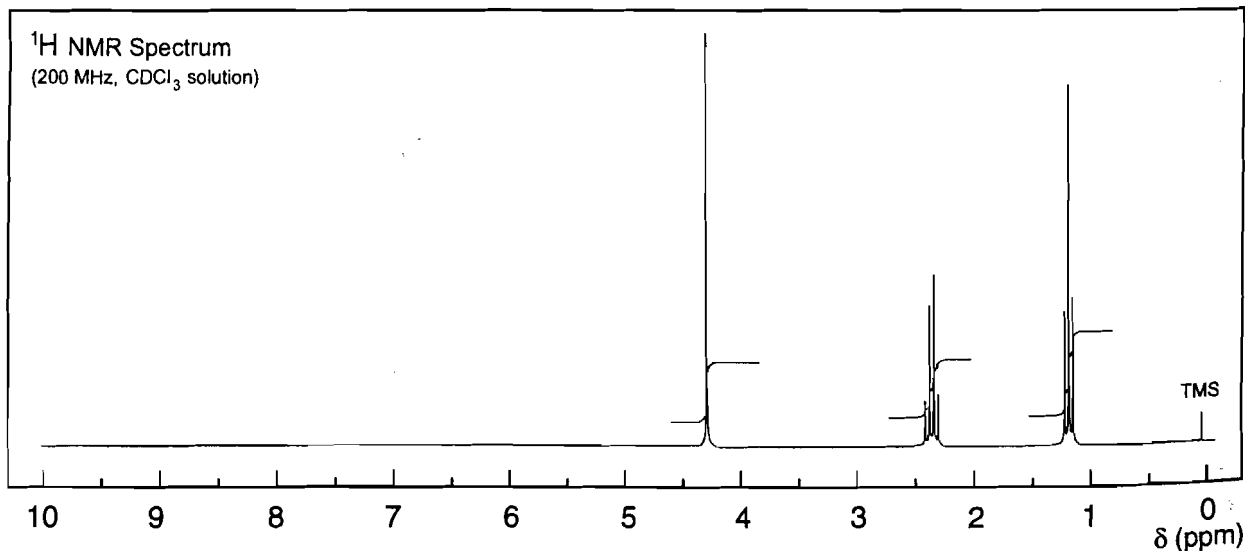
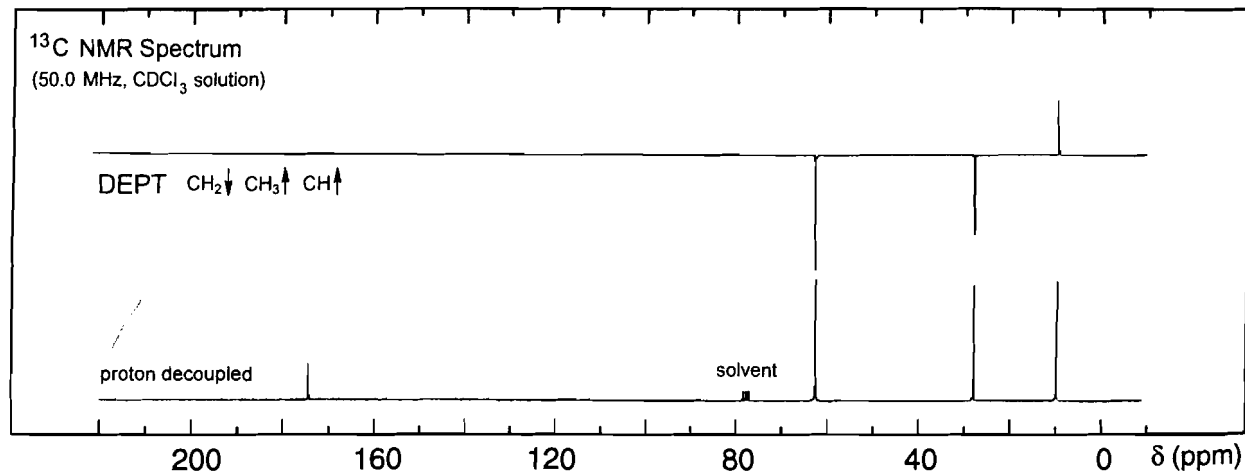

# Problem 50

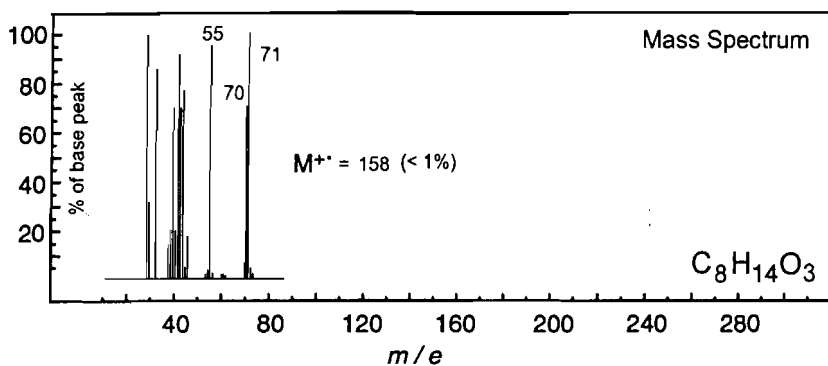
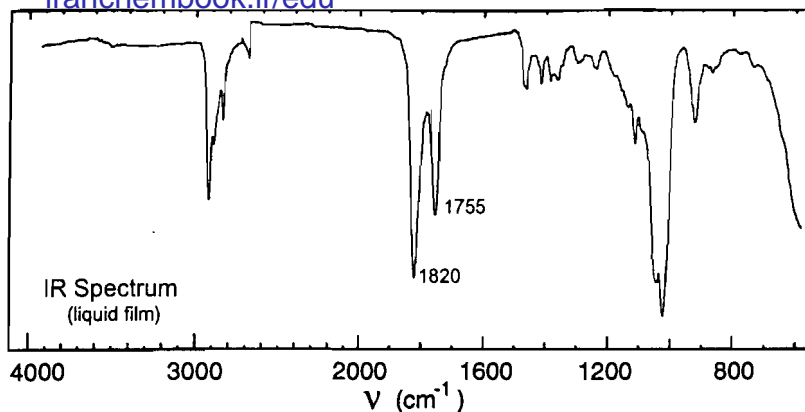

No significant UV absorption above 220 nm

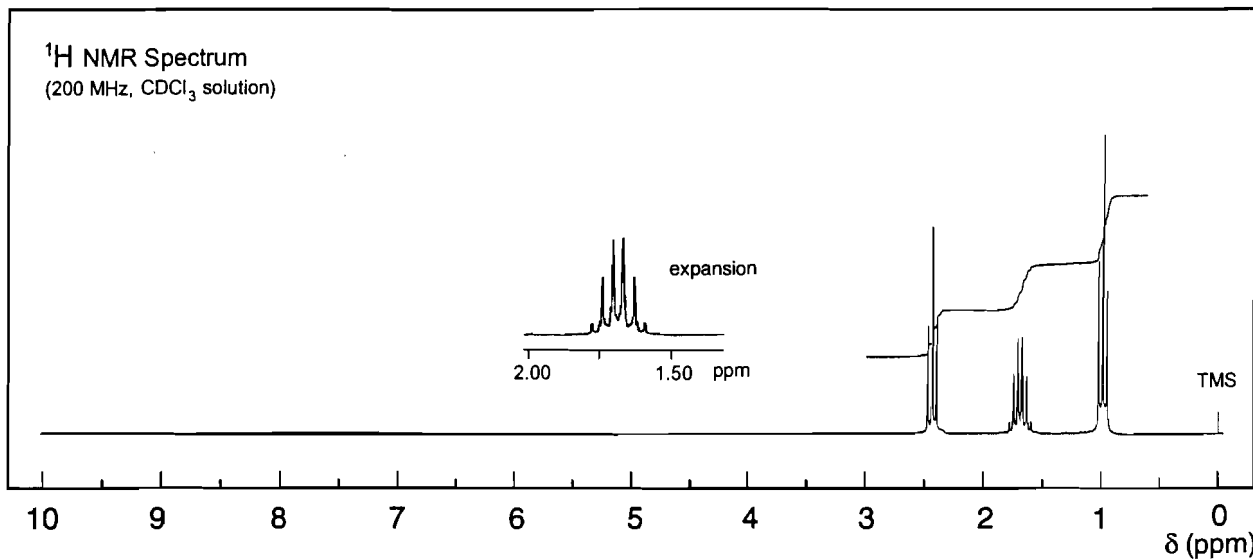
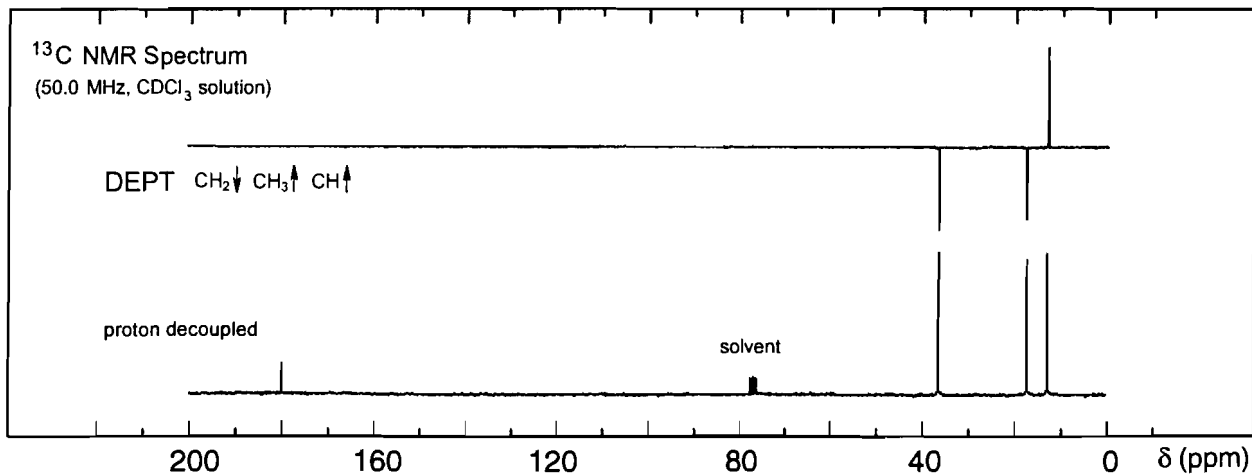

## Problem 51

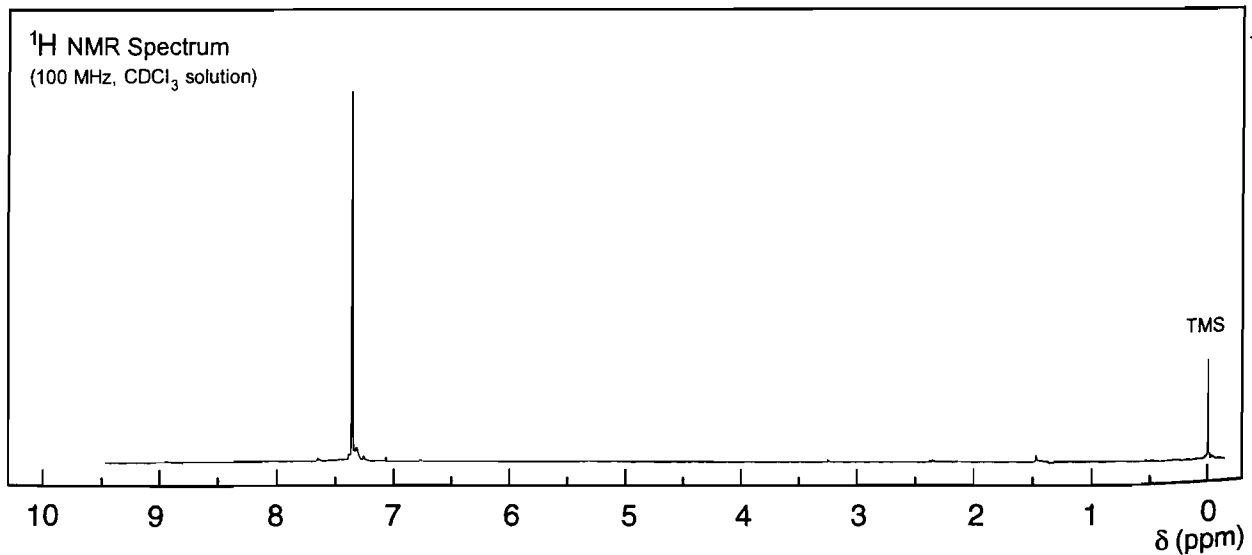
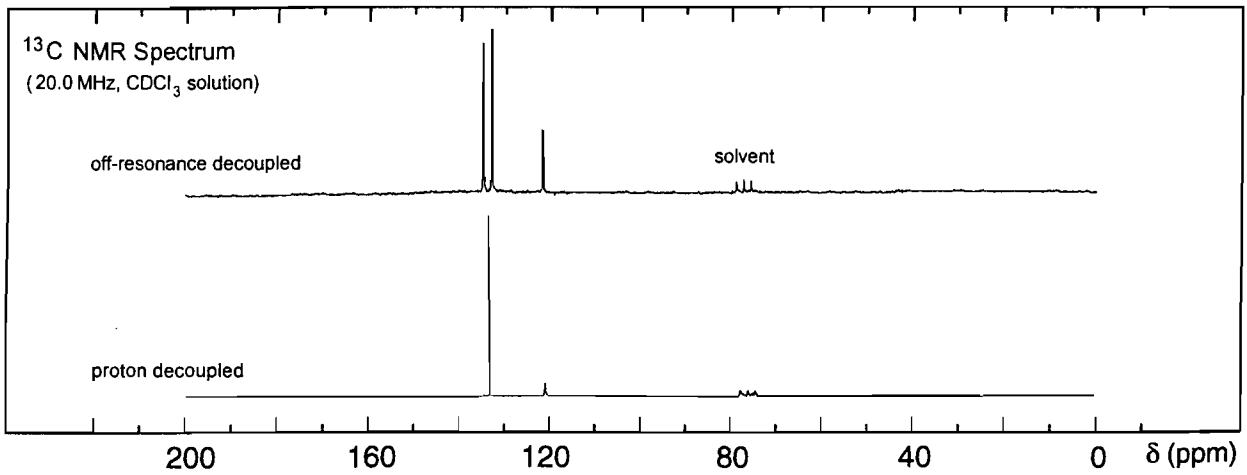
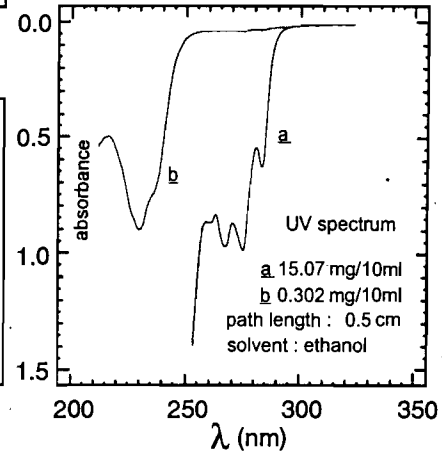
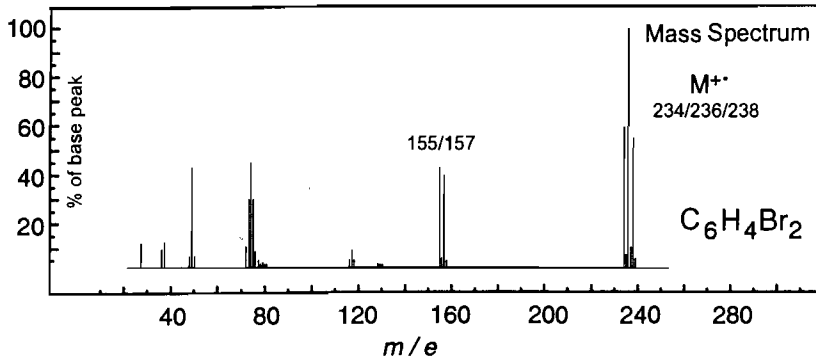
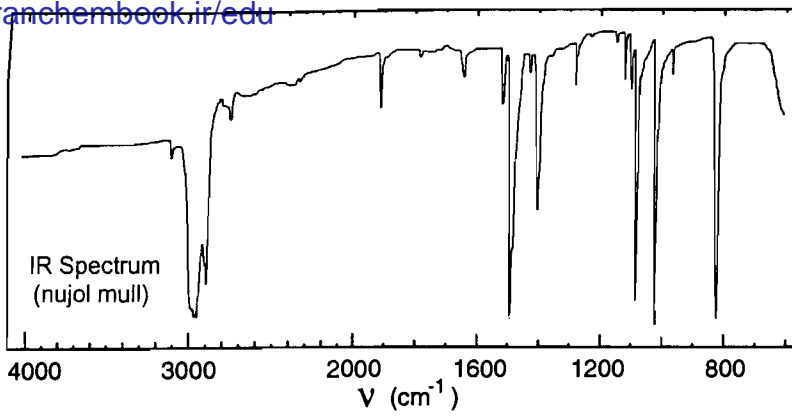

## Problem 52

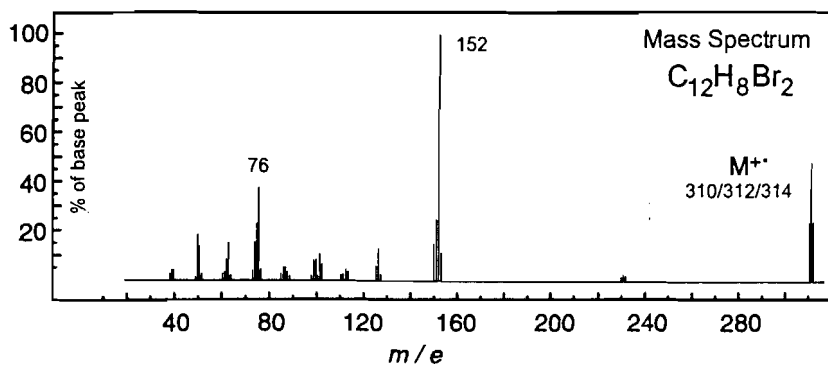
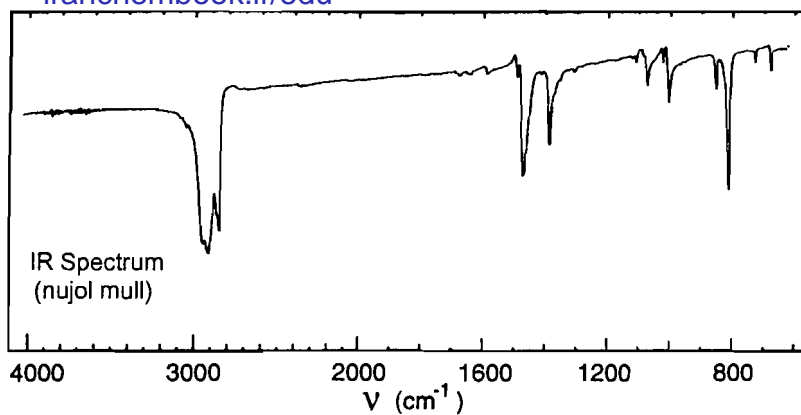

UV Spectrum

 $\lambda_{\max}$  264 nm (log<sub>10</sub>  $\epsilon$  4.5)

solvent : methanol

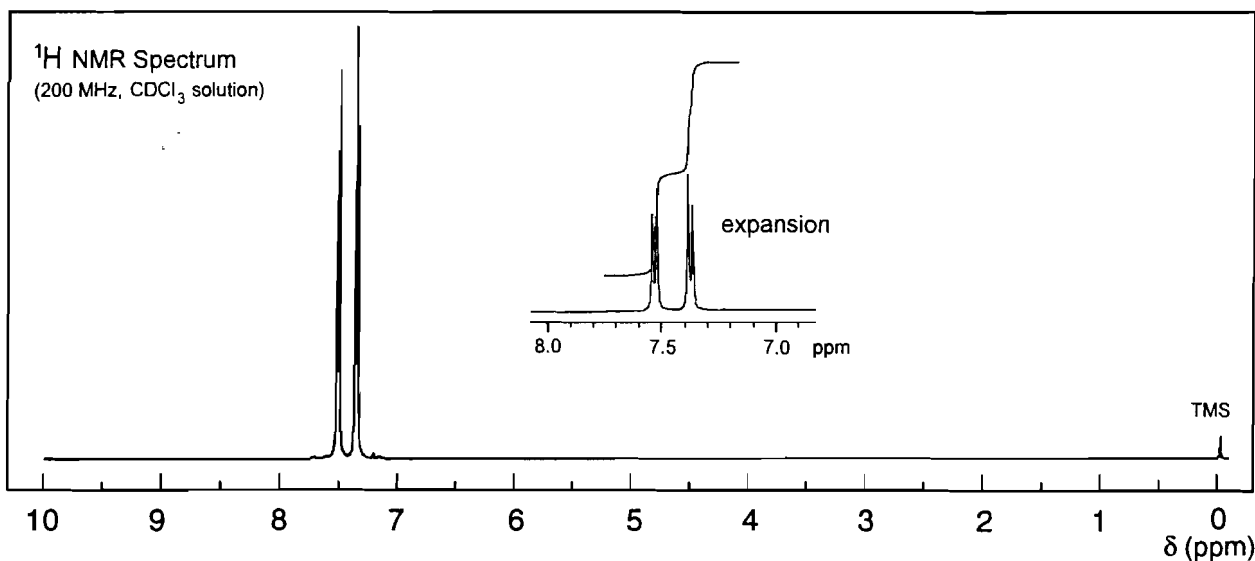
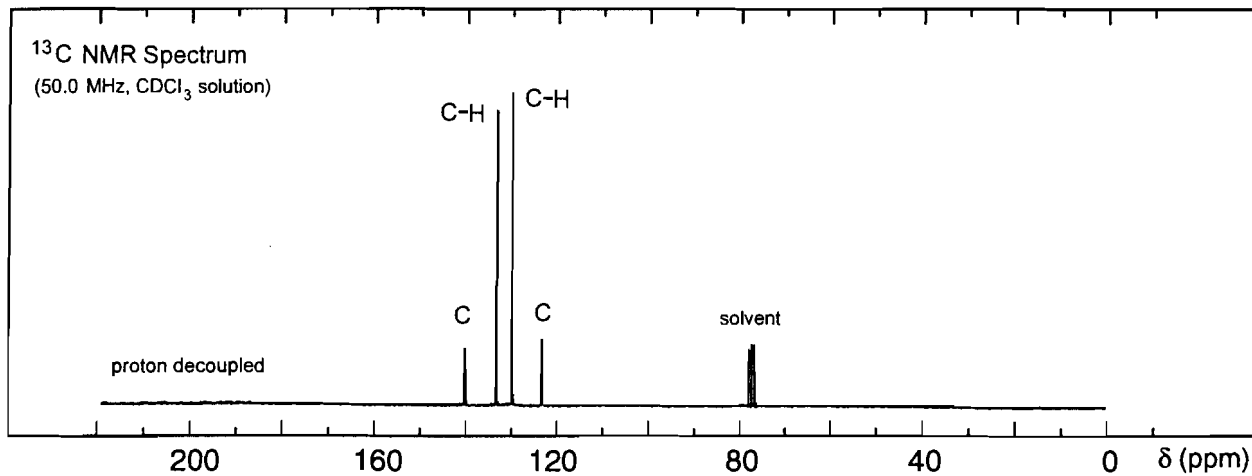

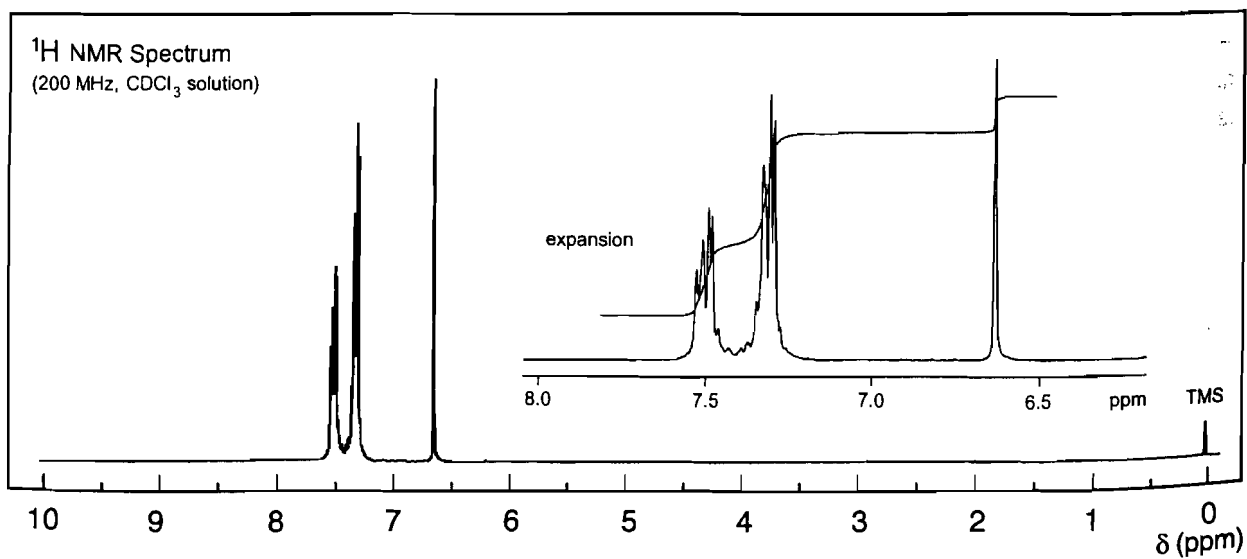
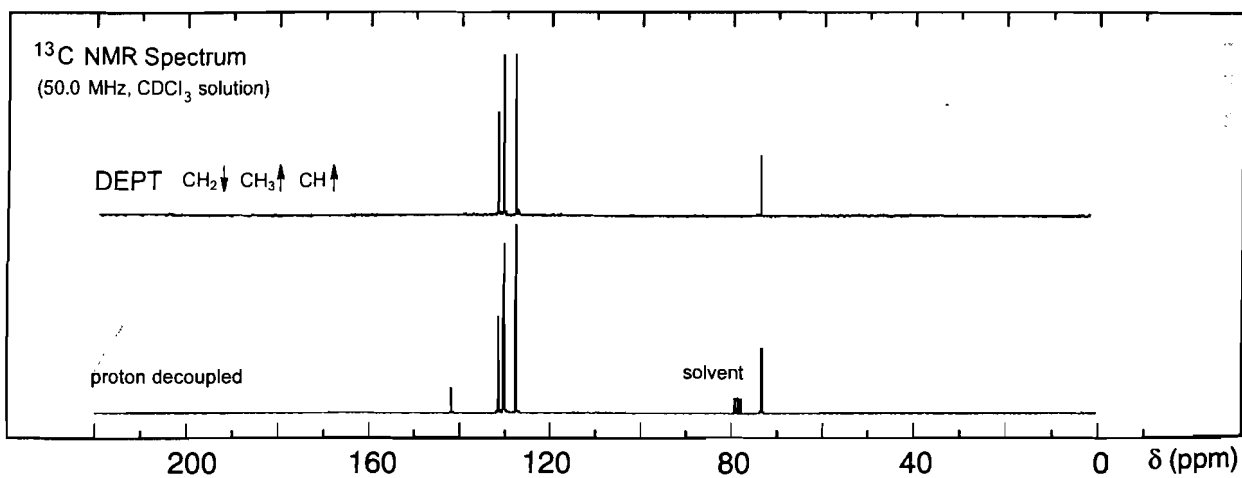
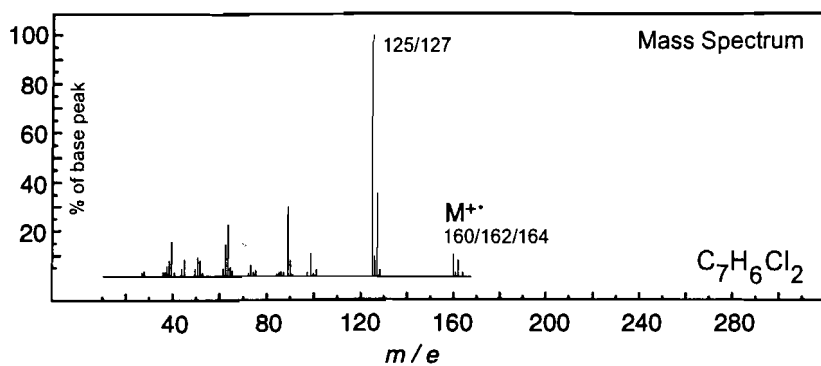
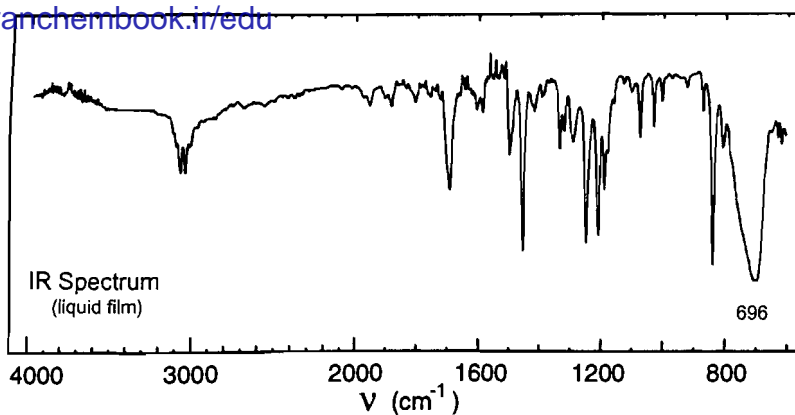

## Problem 54

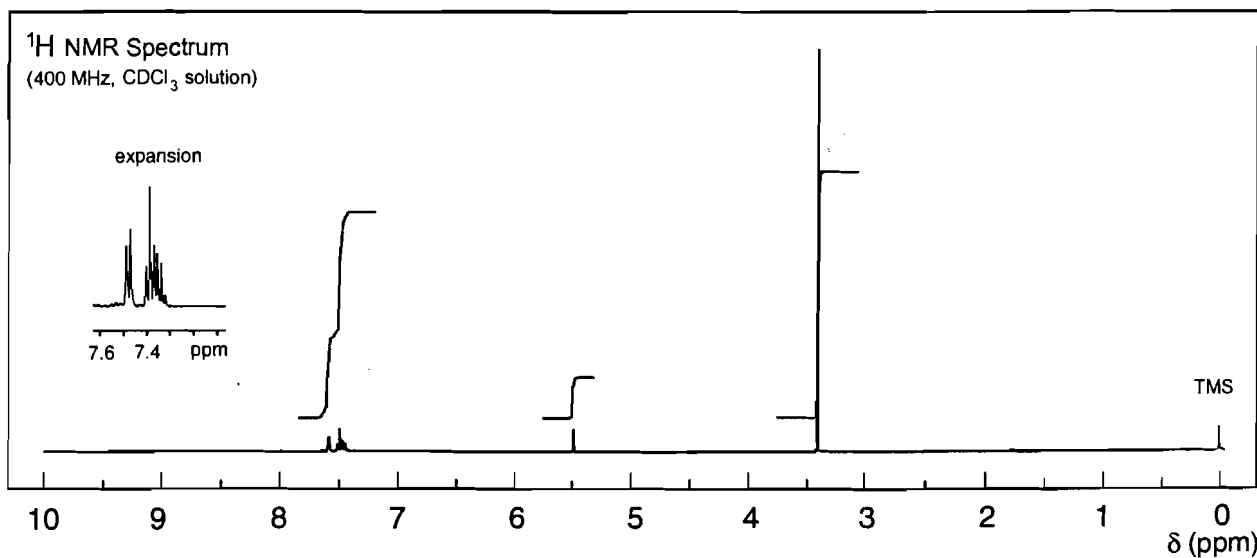
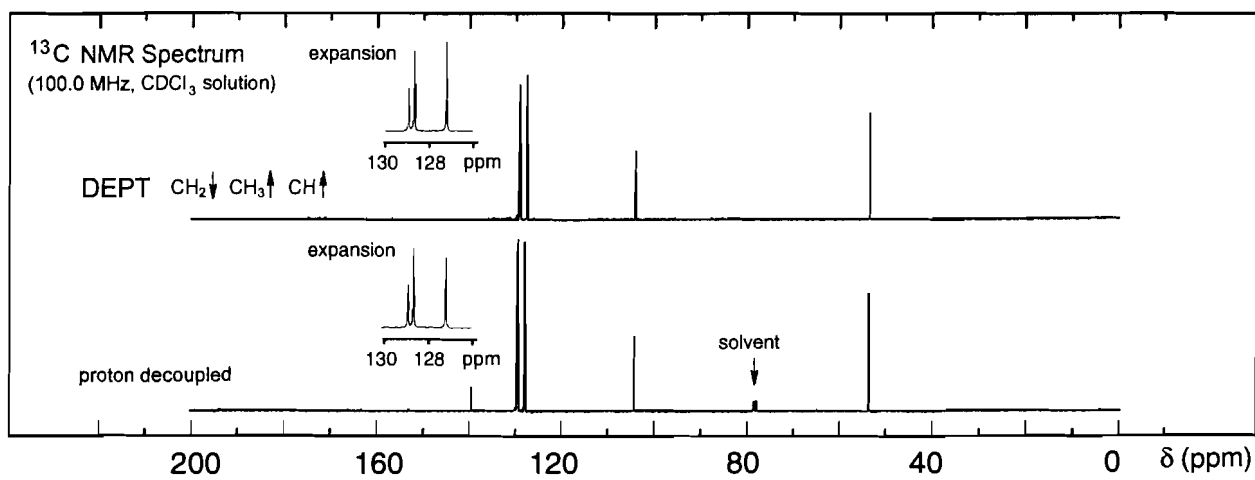
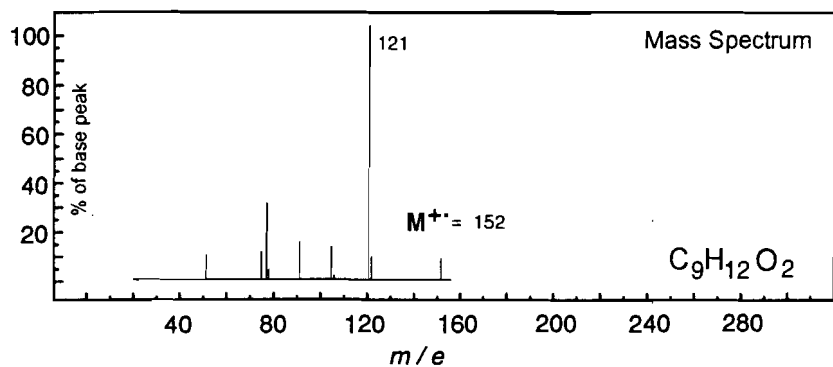
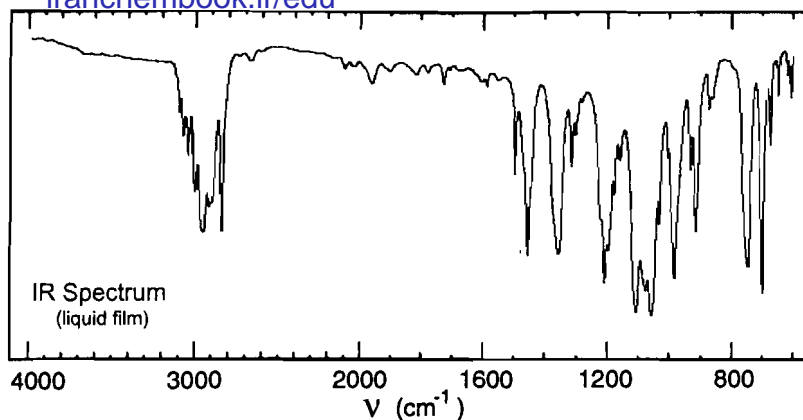



## Problem 55

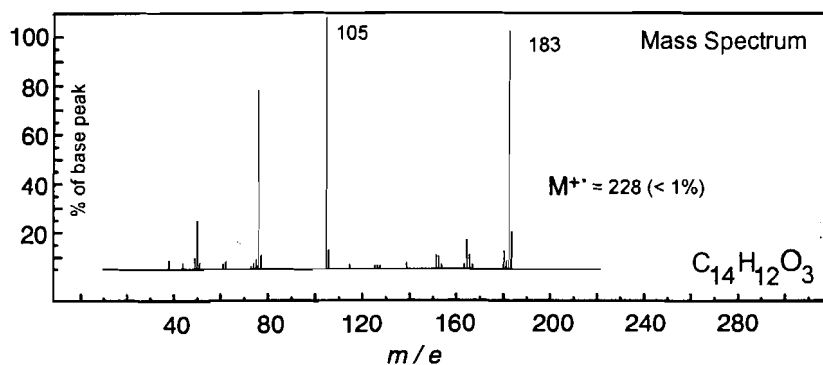
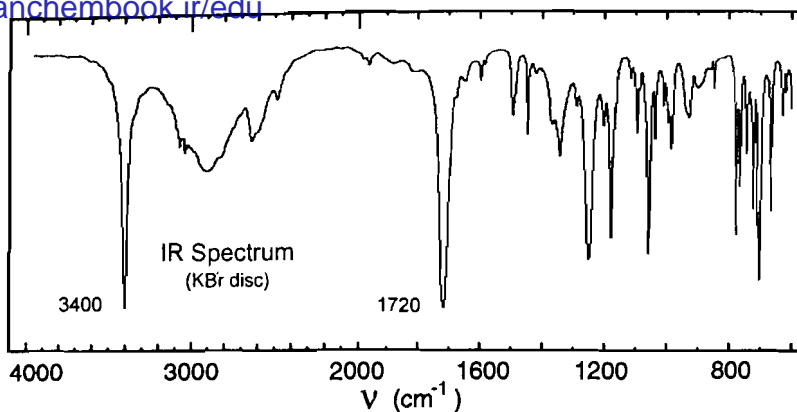

## UV Spectrum

$\lambda_{\text{max}}$  253 nm ( $\log_{10} \epsilon$  2.6)

$\lambda_{\text{max}}$  259 nm ( $\log_{10} \epsilon$  2.7)

$\lambda_{\text{max}}$  264 nm ( $\log_{10} \epsilon$  2.5)

solvent : ethanol

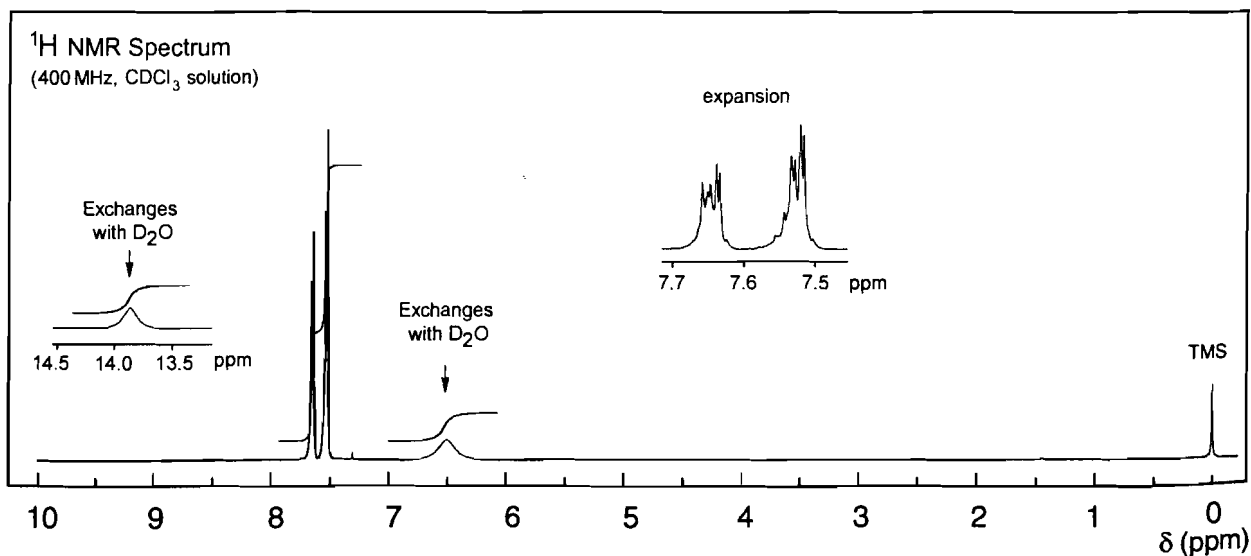
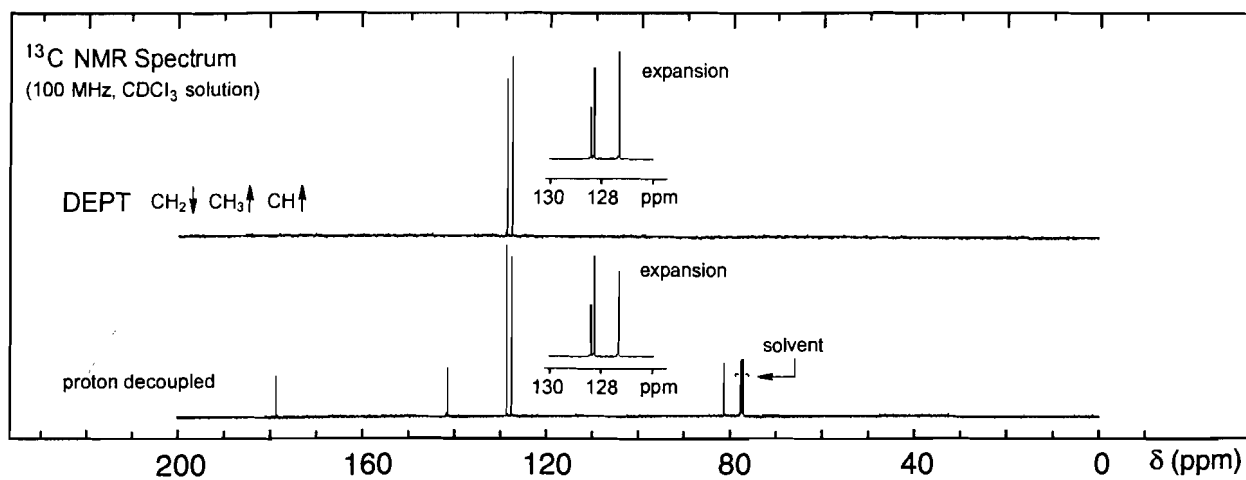

## Problem 56

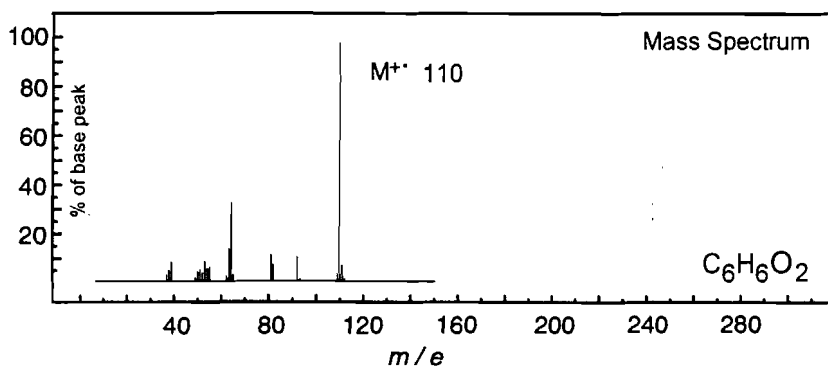
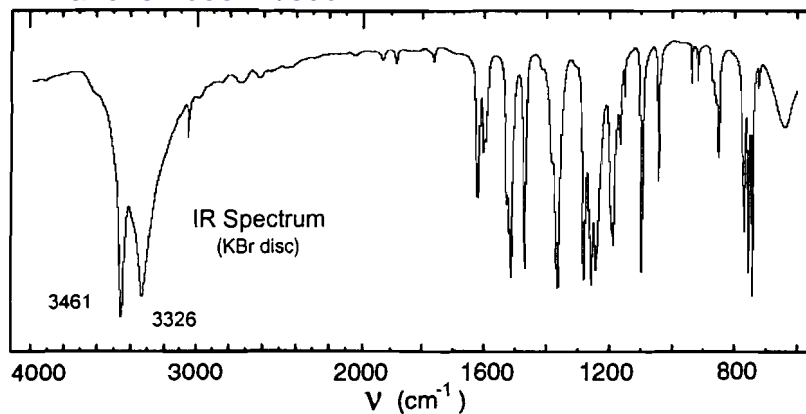

UV Spectrum

 $\lambda_{\text{max}}$  225 nm ( $\log_{10}\epsilon$  3.5) $\lambda_{\text{max}}$  276 nm ( $\log_{10}\epsilon$  3.4) $\lambda_{\text{max}}$  283 nm ( $\log_{10}\epsilon$  3.3)

solvent : methanol

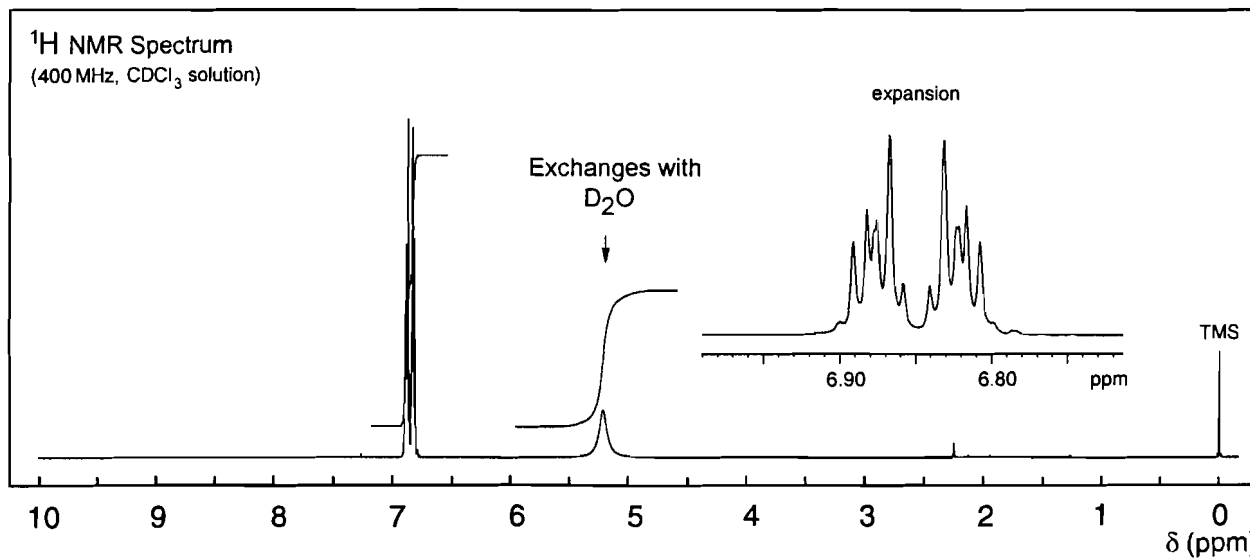
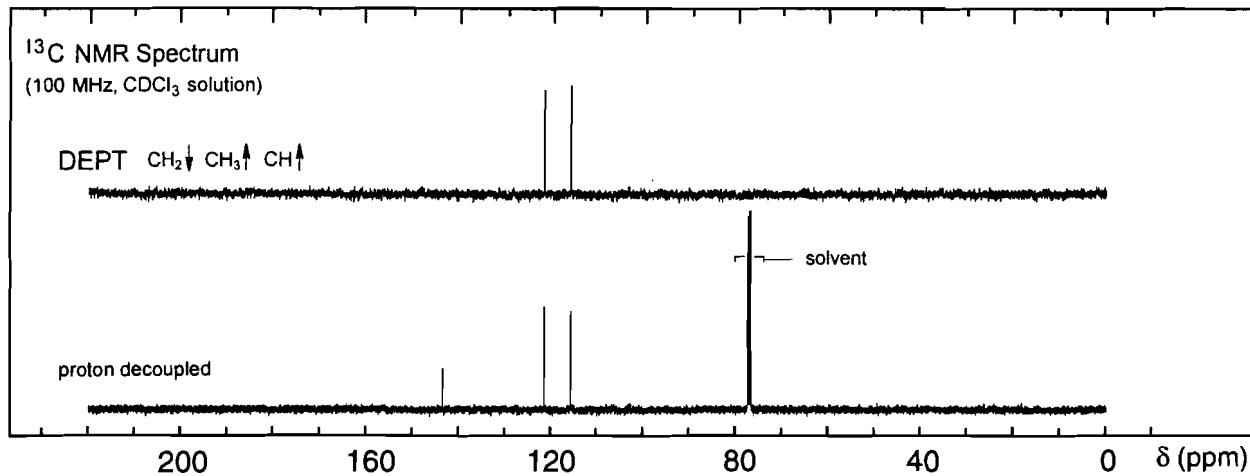

## Problem 57

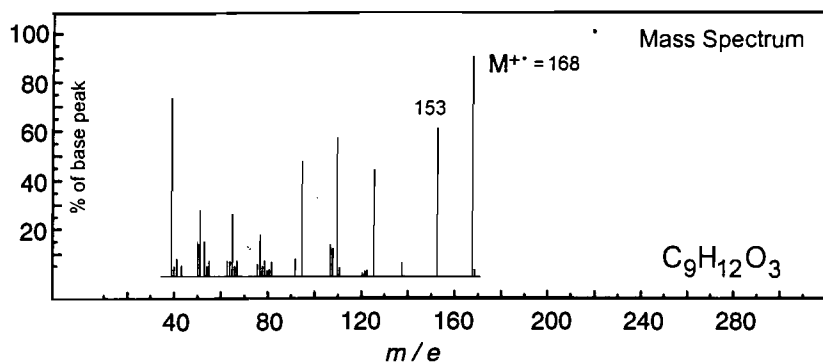
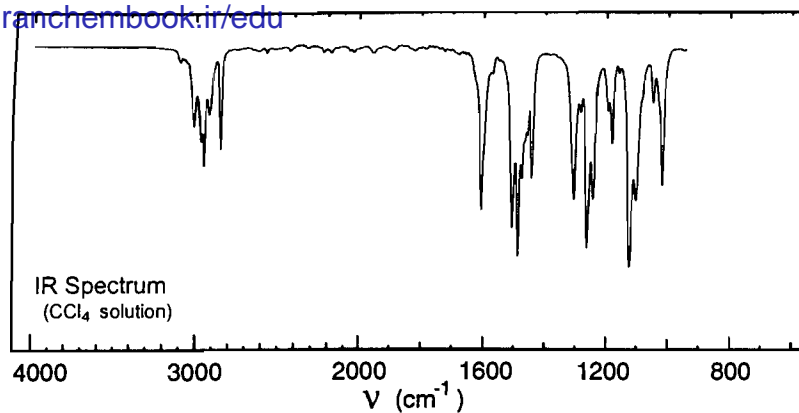

UV Spectrum

 $\lambda_{\text{max}}$  267 nm ( $\log_{10} \epsilon$  2.8)

solvent: ethanol

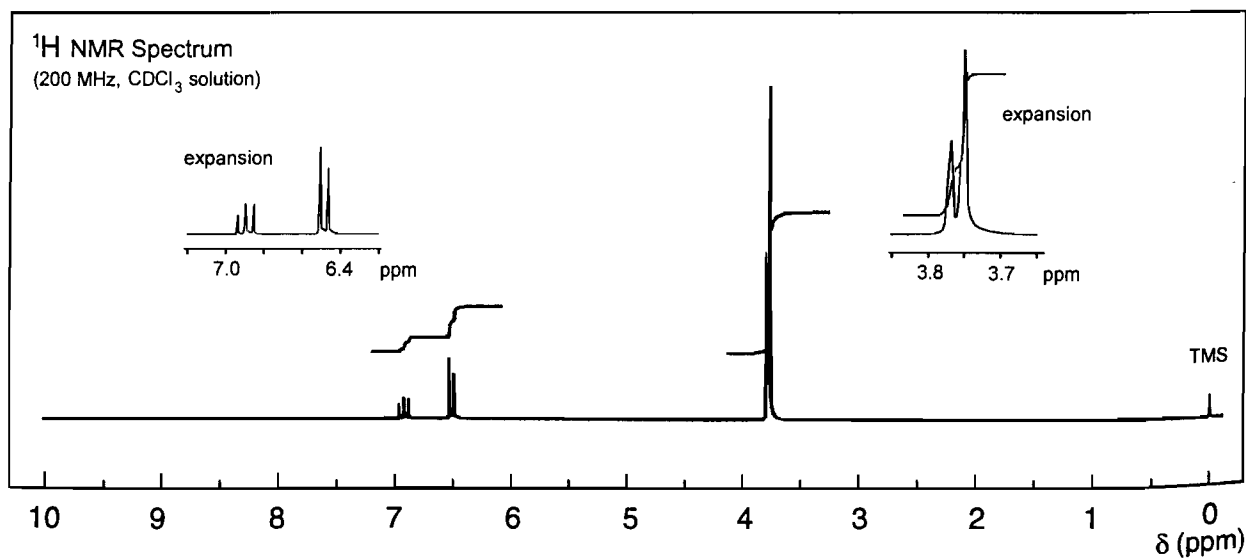
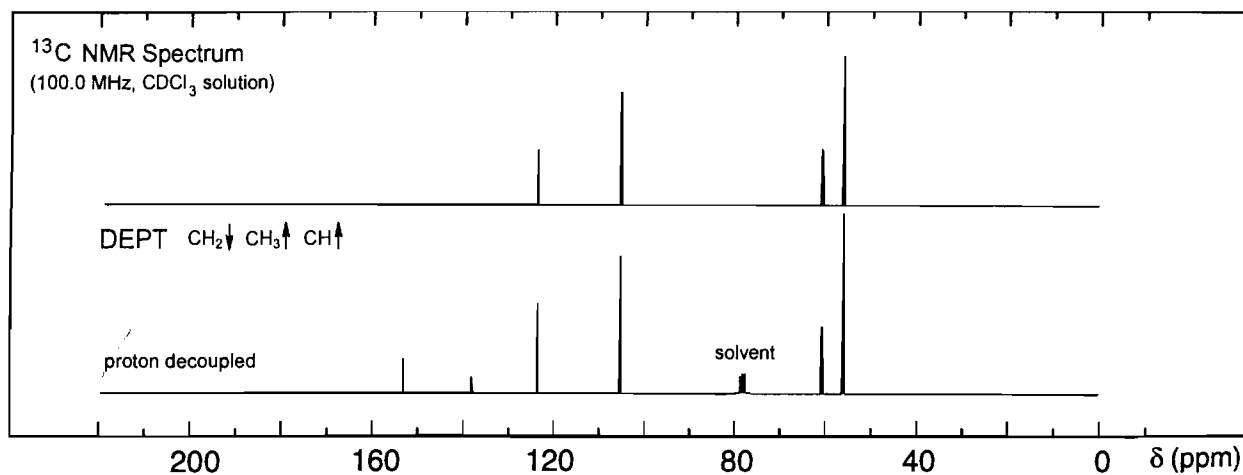

## Problem 58

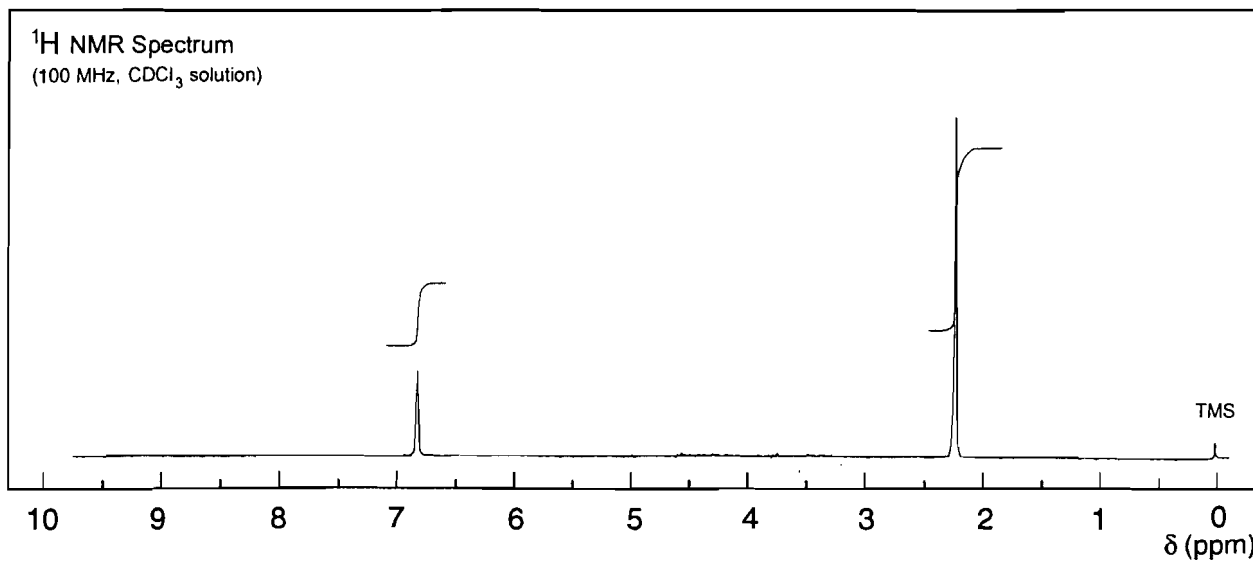
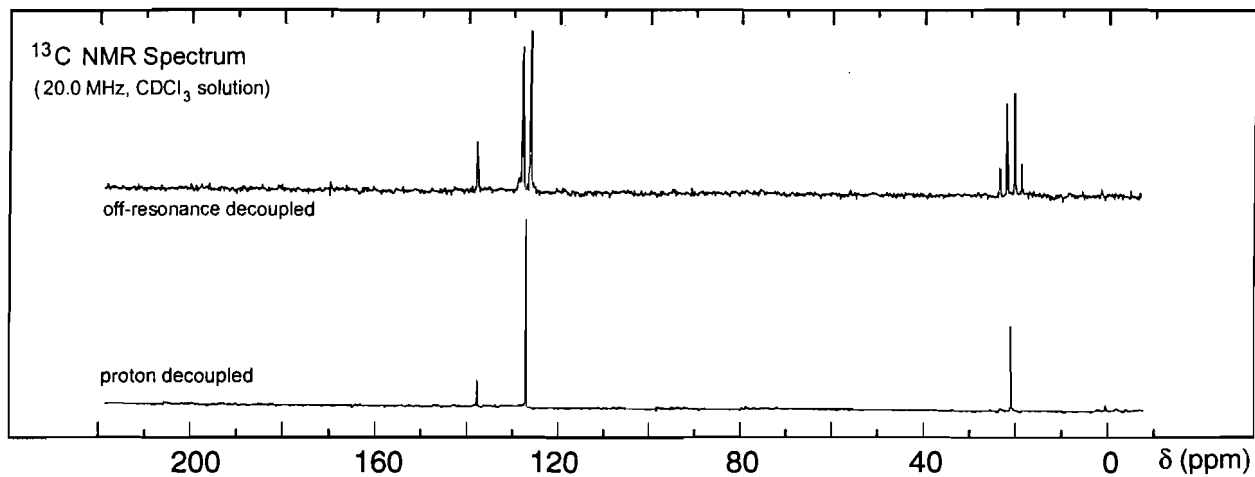
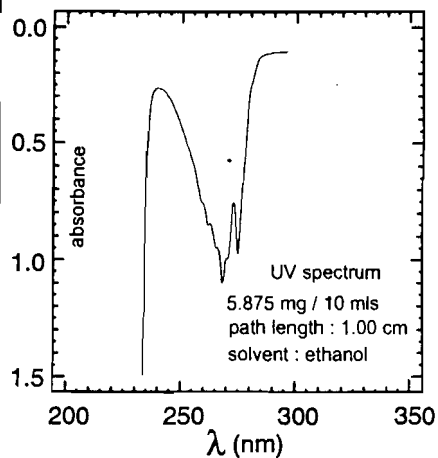
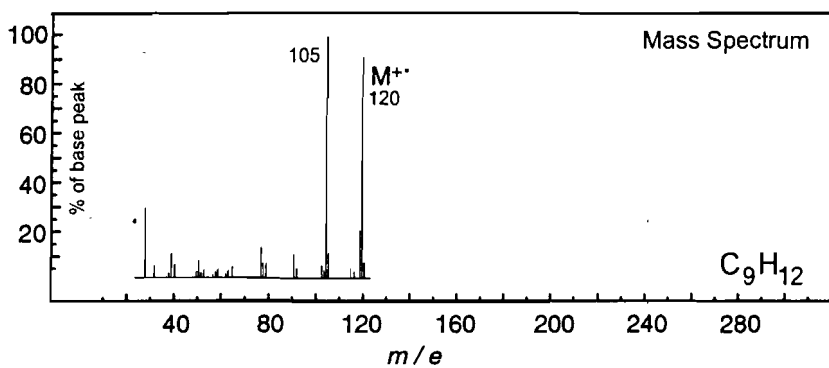
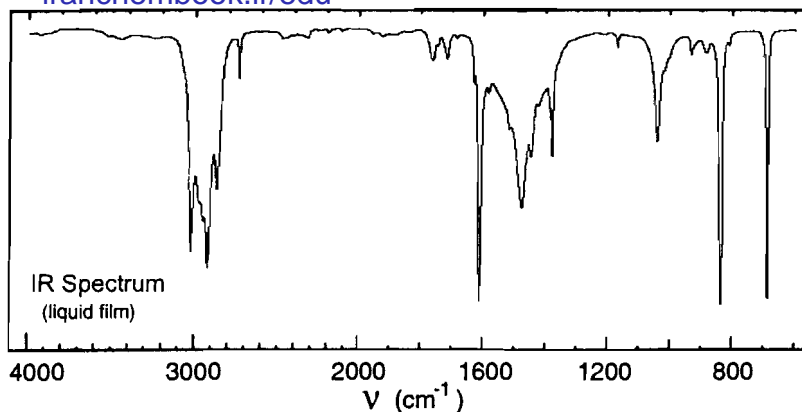

## Problem 59

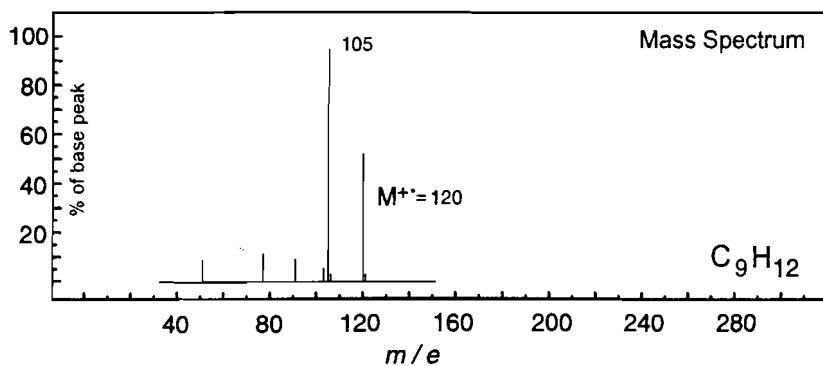
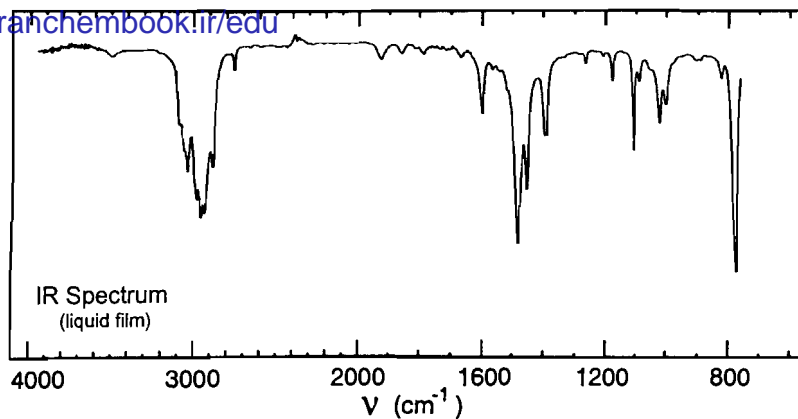

UV Spectrum

 $\lambda_{\text{max}}$  261 nm ( $\log_{10} \epsilon$  2.7) $\lambda_{\text{max}}$  269 nm ( $\log_{10} \epsilon$  2.5)

solvent: methanol.

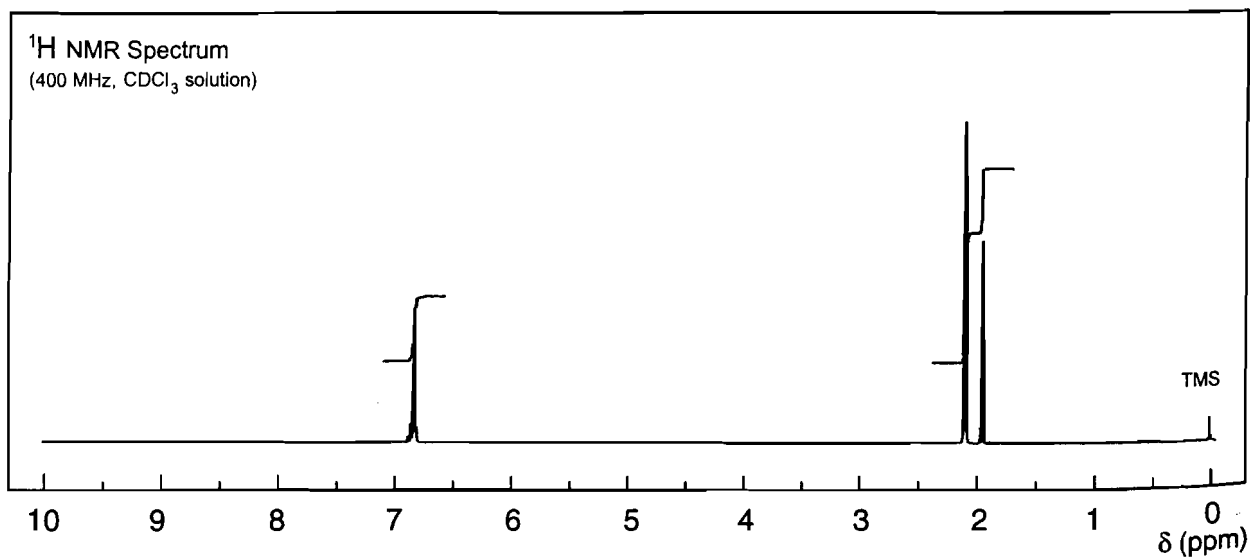
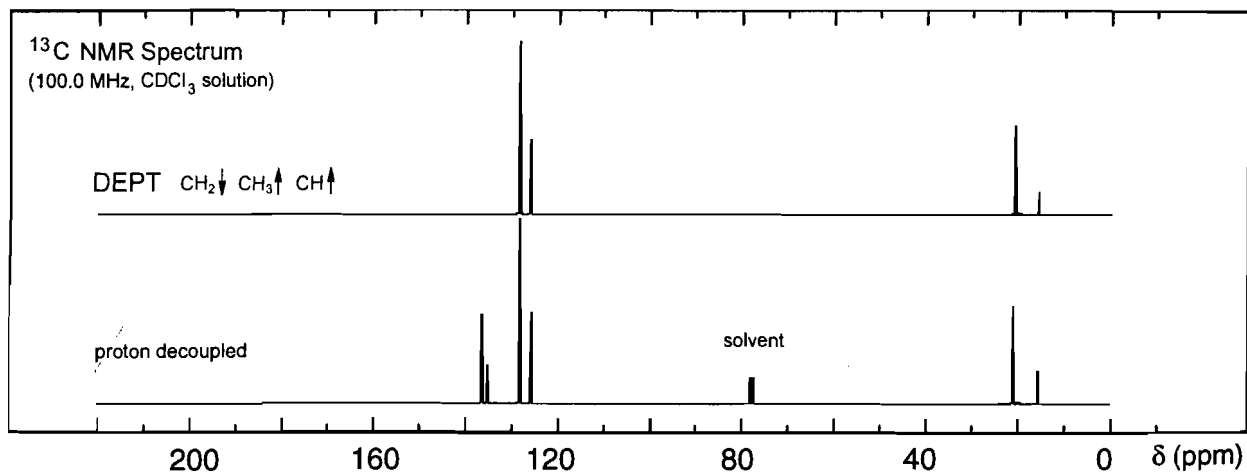

## Problem 60

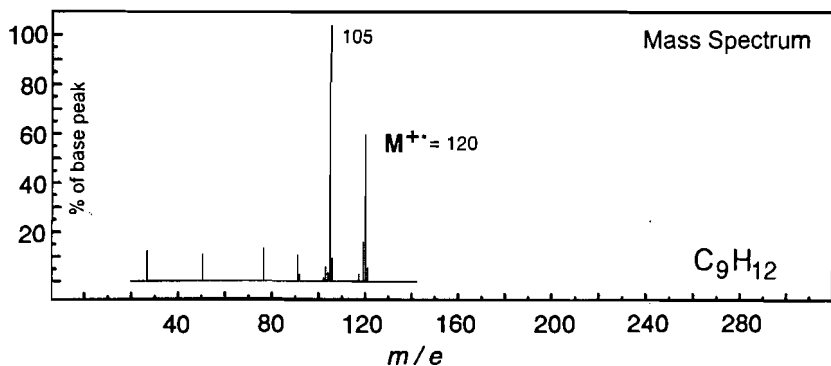
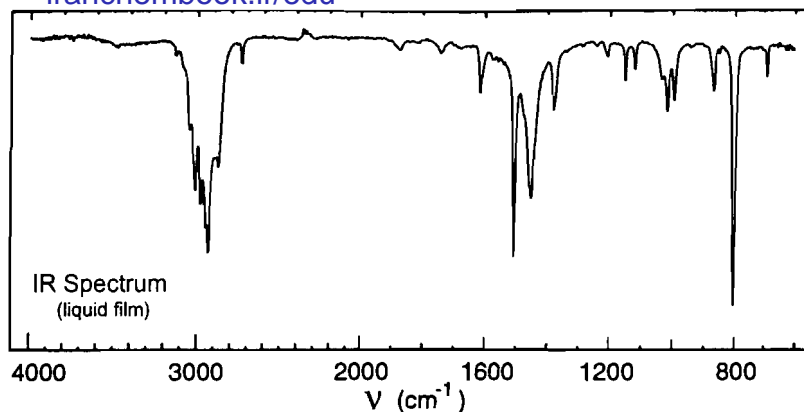

UV Spectrum

$$\lambda_{\text{max}} 270 \text{ nm } (\log_{10} \epsilon 2.6)$$

solvent : methanol

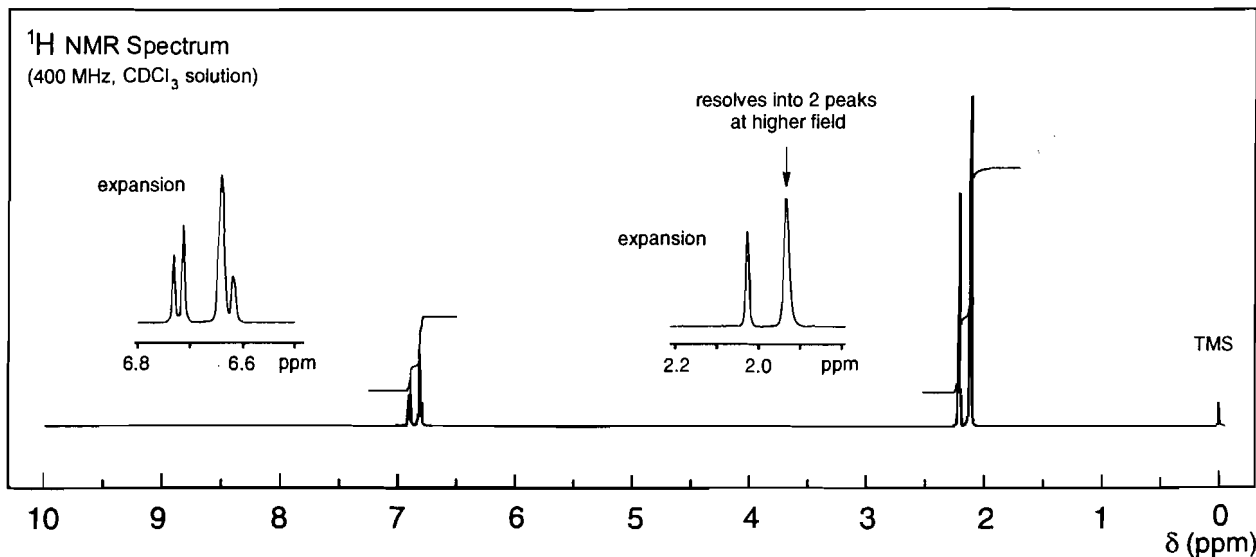
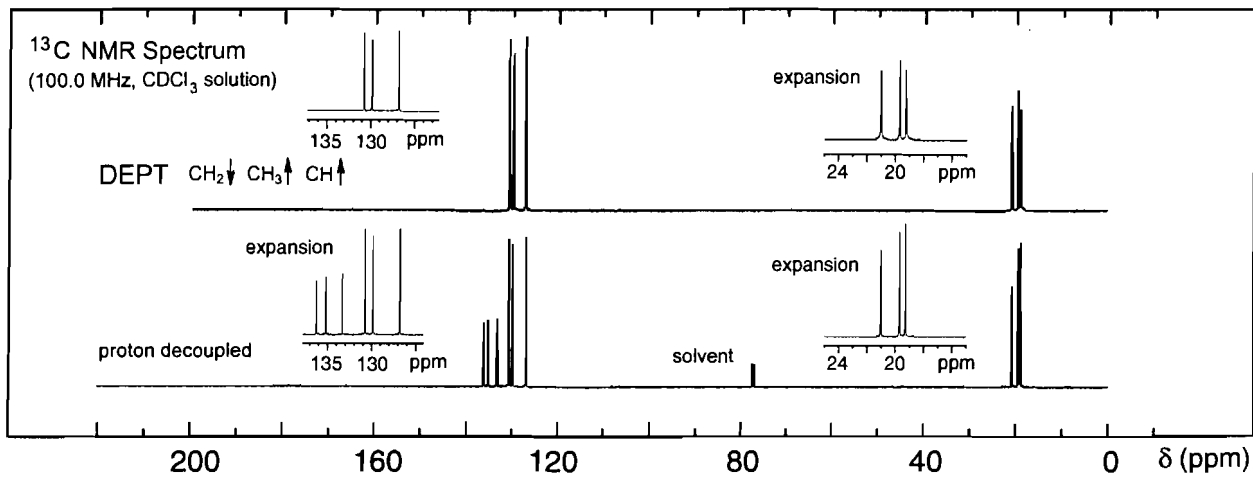

## Problem 61

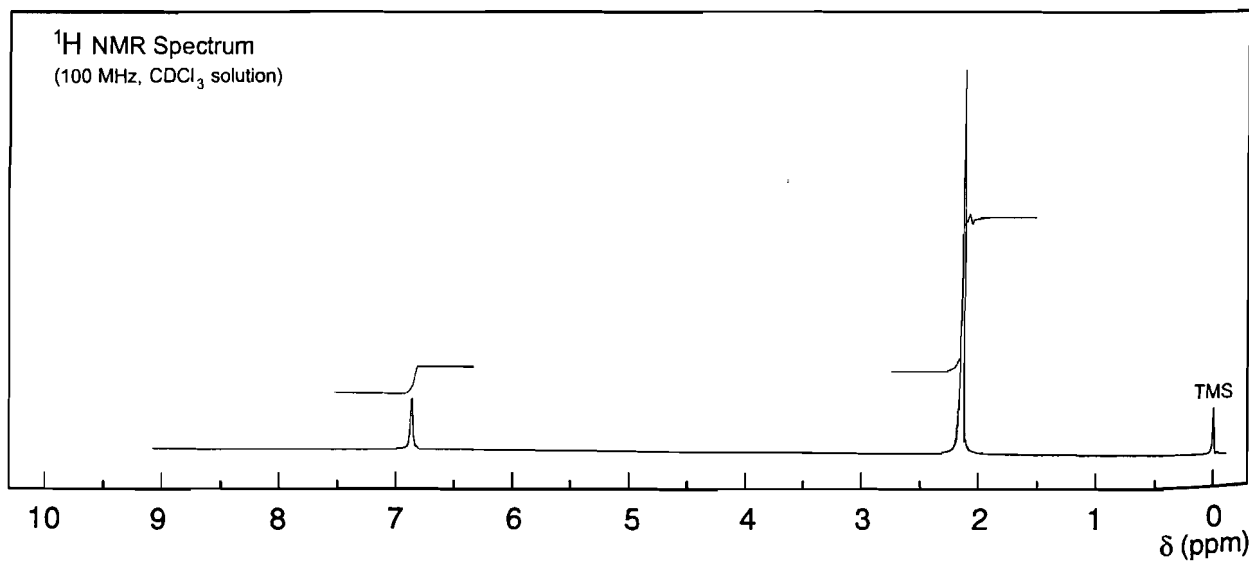
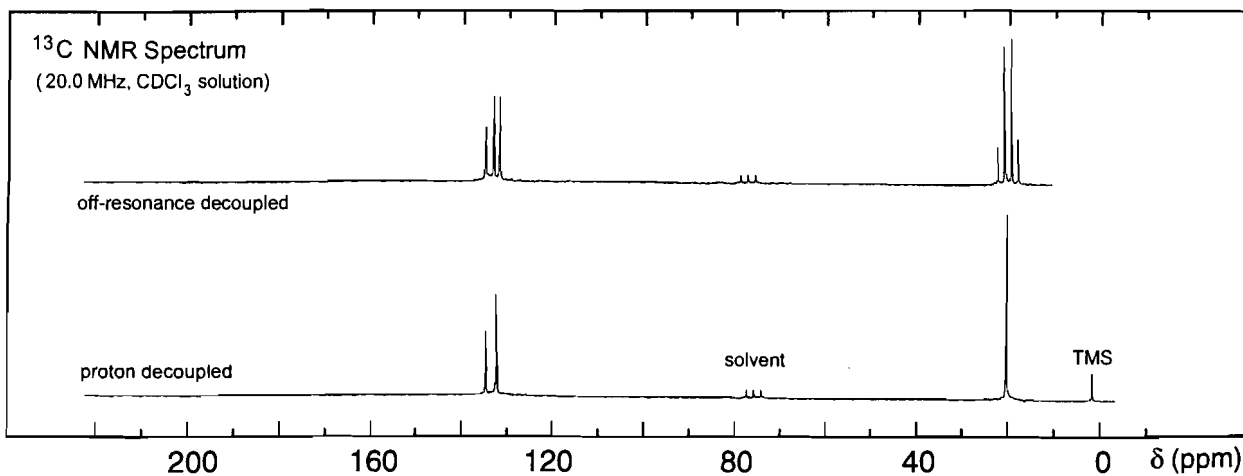
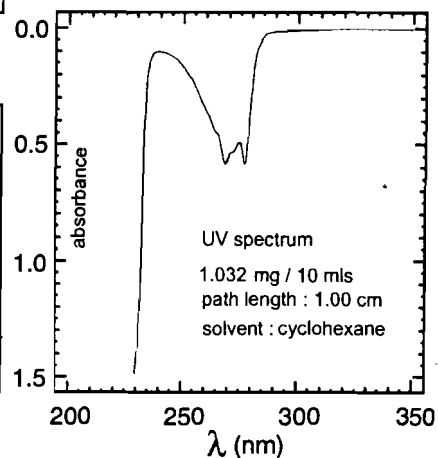
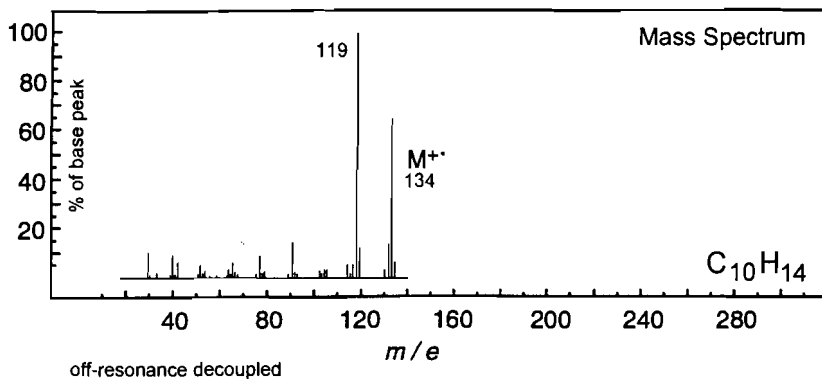
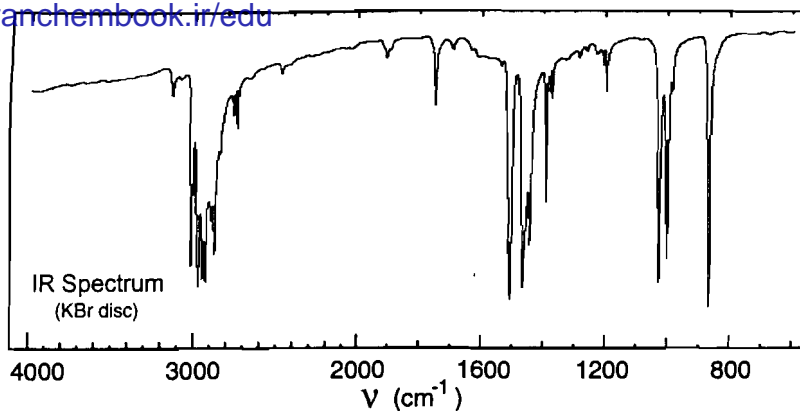

## Problem 62

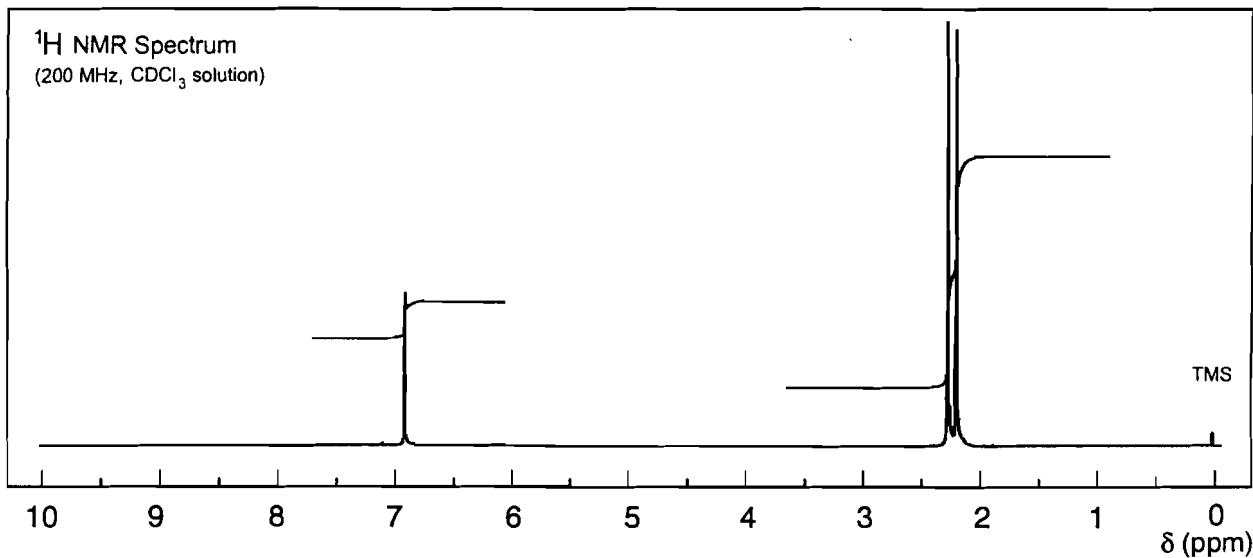
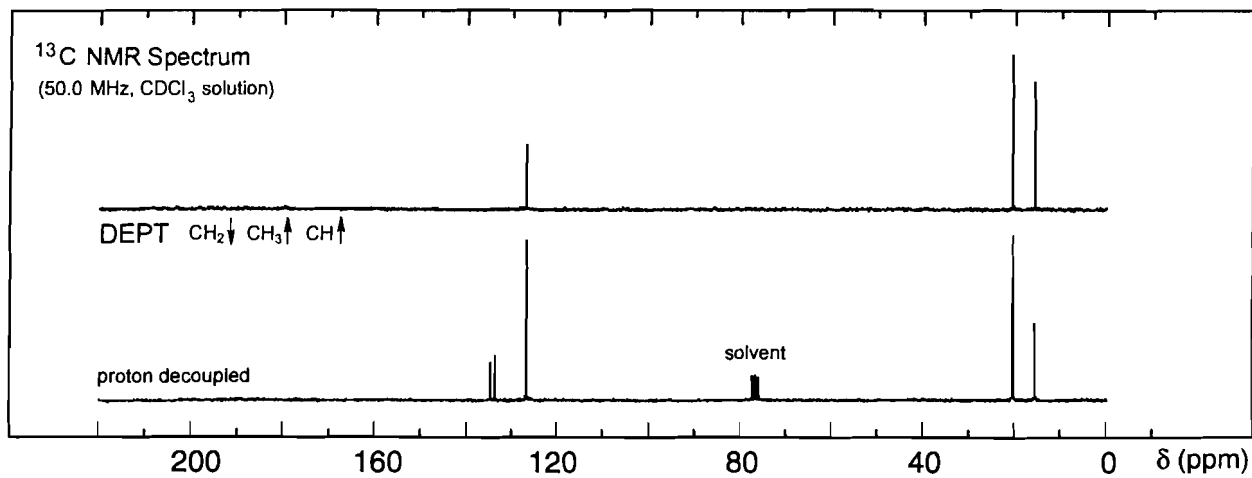
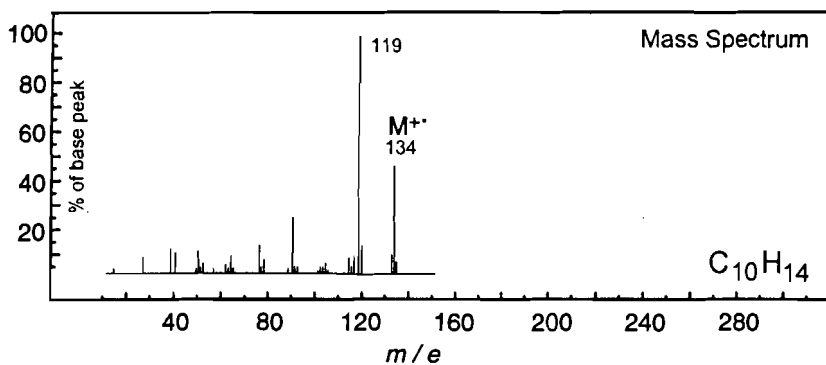
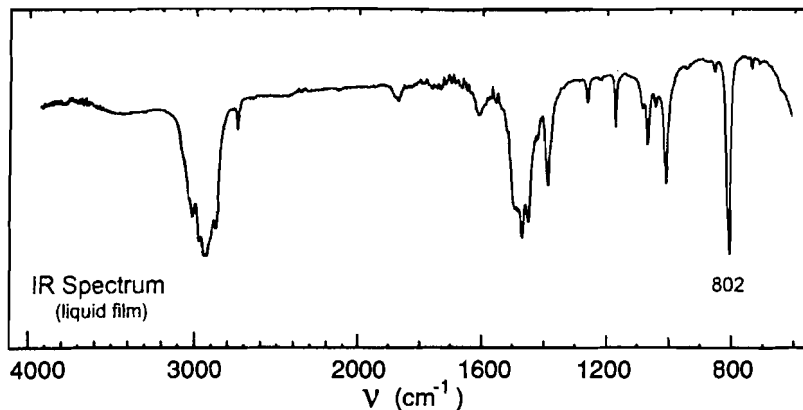



## Problem 63

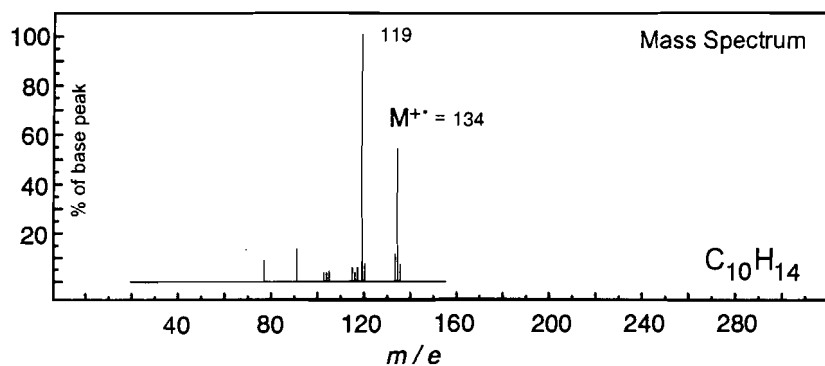
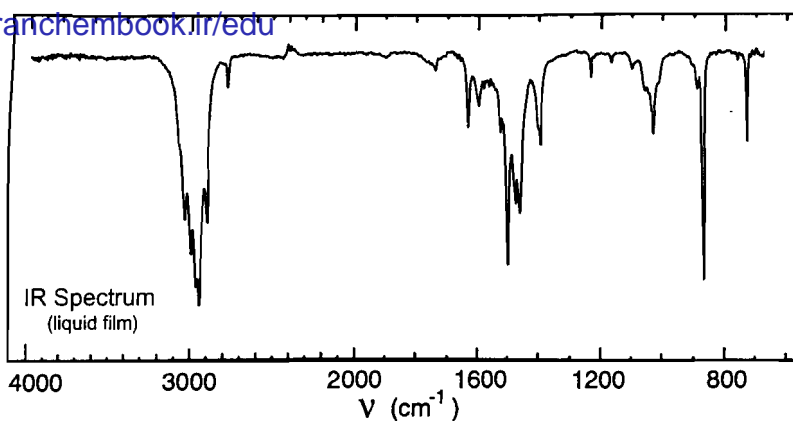

UV Spectrum

 $\lambda_{\max}$  274 nm ( $\log_{10} \epsilon$  2.3) $\lambda_{\max}$  277 nm ( $\log_{10} \epsilon$  2.3)

solvent : cyclohexane

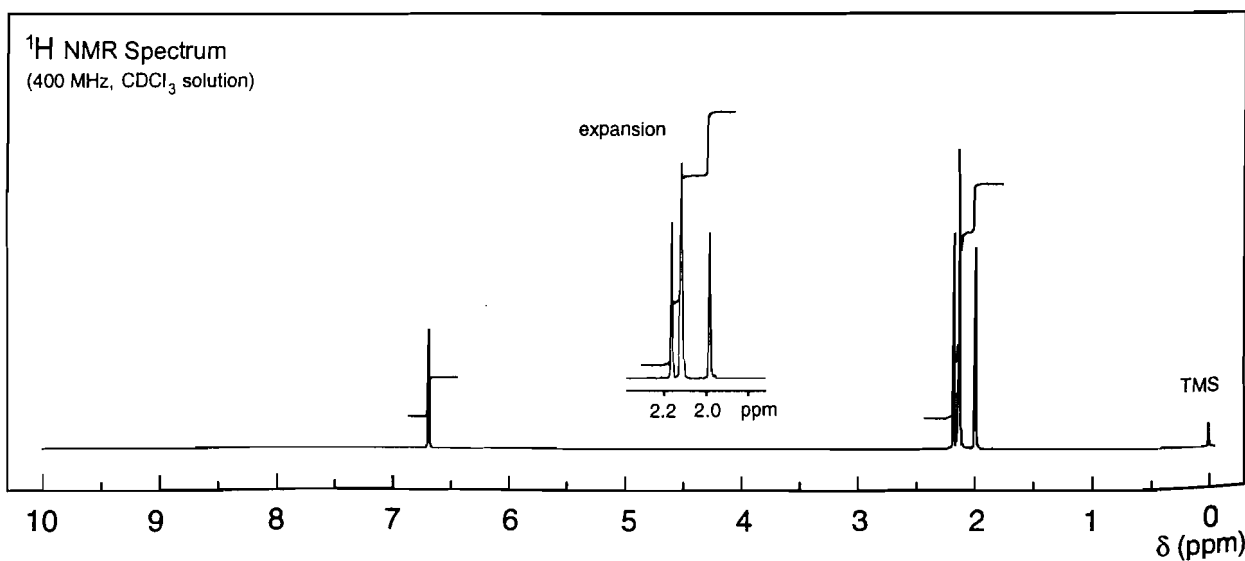
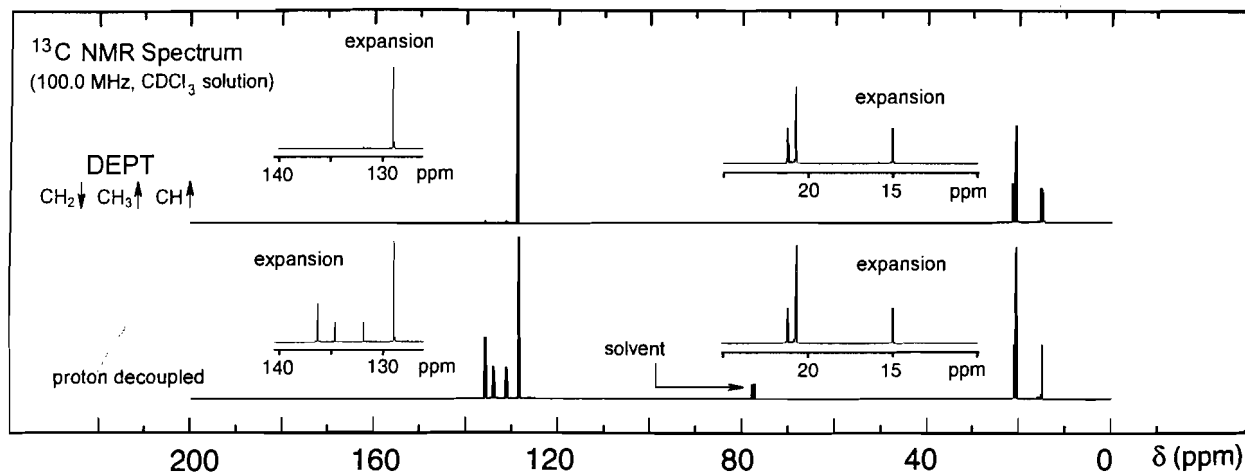

## Problem 64

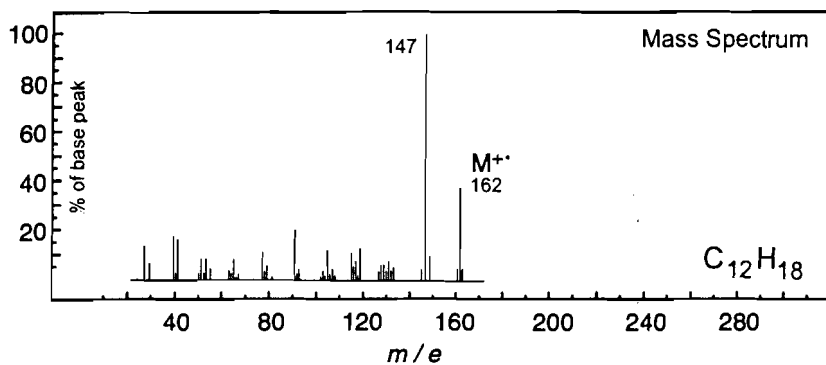
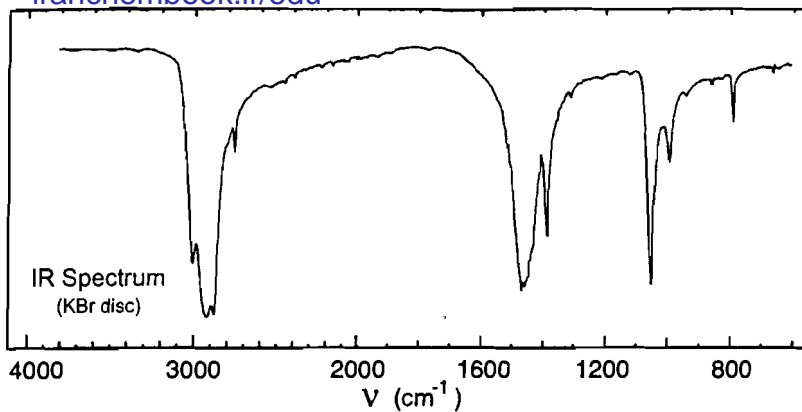

UV Spectrum

 $\lambda_{\max}$  278 nm ( $\log_{10} \epsilon$  2.4) $\lambda_{\max}$  274 nm ( $\log_{10} \epsilon$  2.4) $\lambda_{\max}$  270 nm ( $\log_{10} \epsilon$  2.5)

solvent : methanol

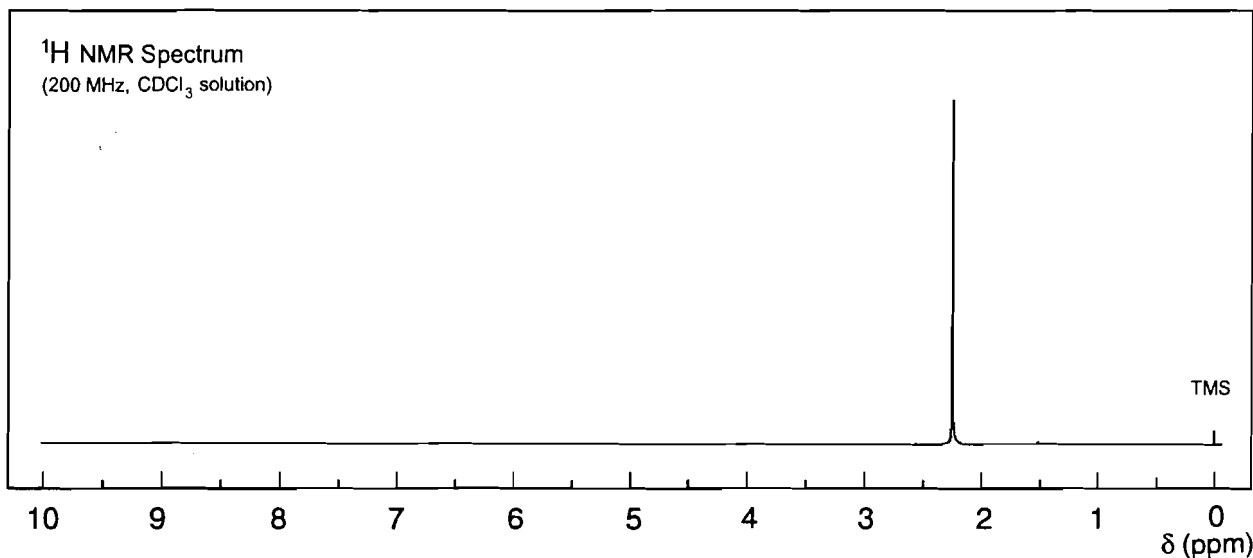
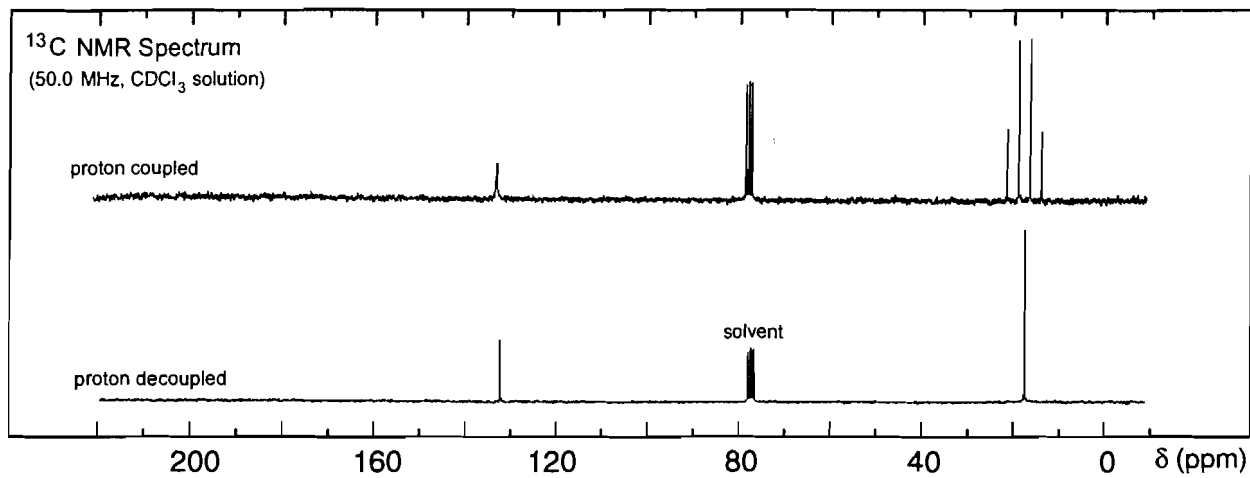

## Problem 65

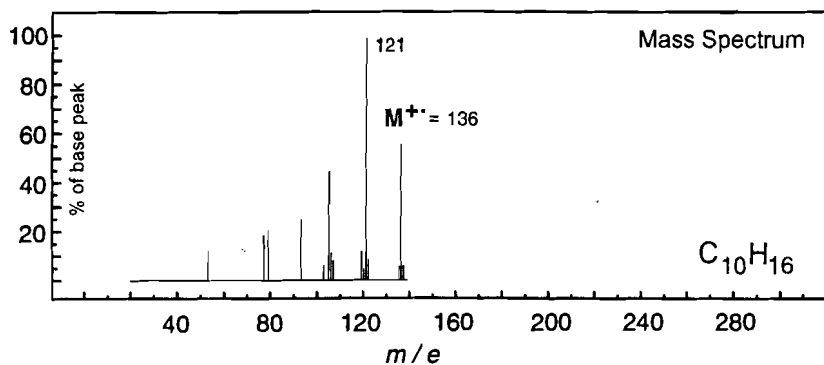
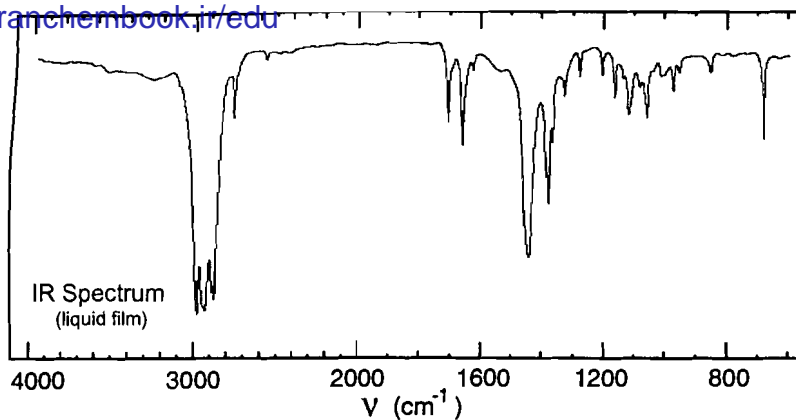

UV Spectrum

 $\lambda_{\max}$  232 nm ( $\log_{10} \epsilon$  3.4) $\lambda_{\max}$  248 nm ( $\log_{10} \epsilon$  3.5) $\lambda_{\max}$  265 nm ( $\log_{10} \epsilon$  3.4)

solvent: isooctane

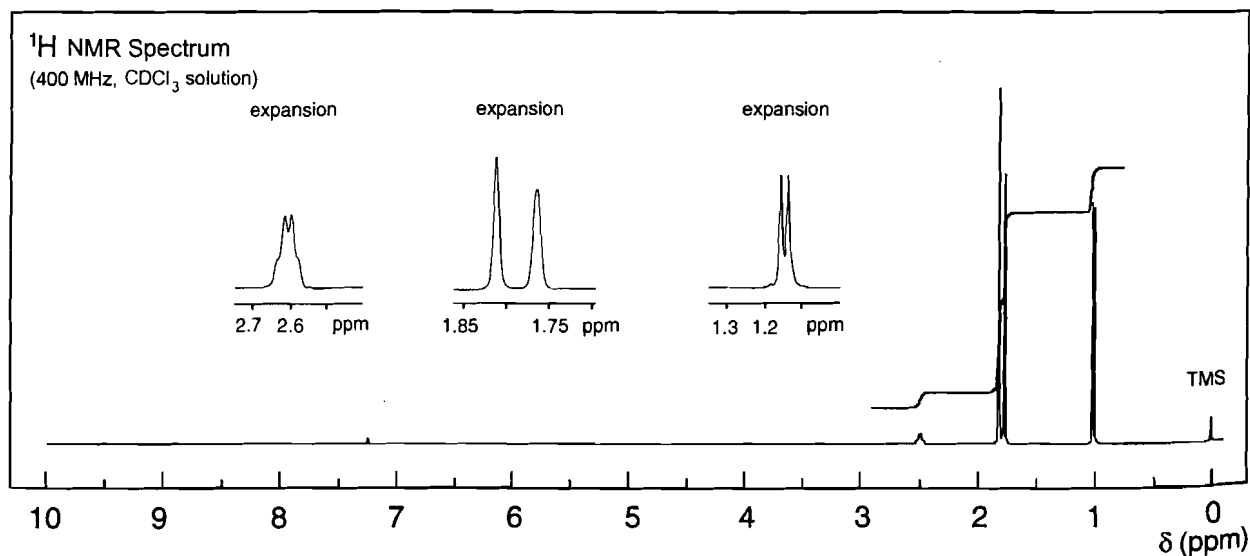
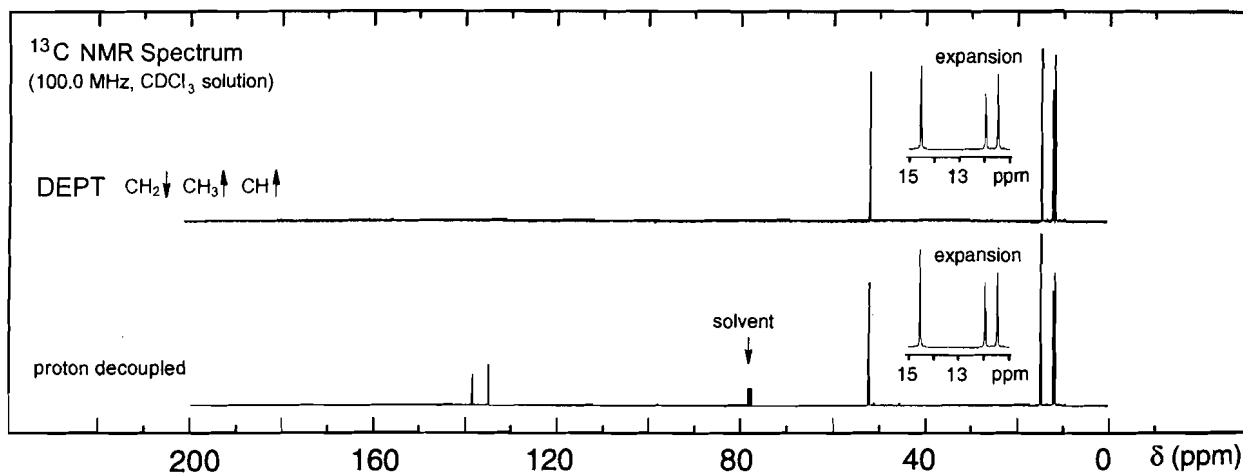

## Problem 66

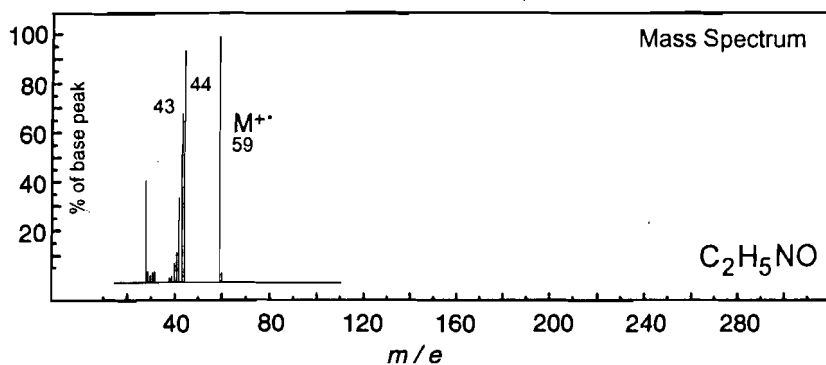
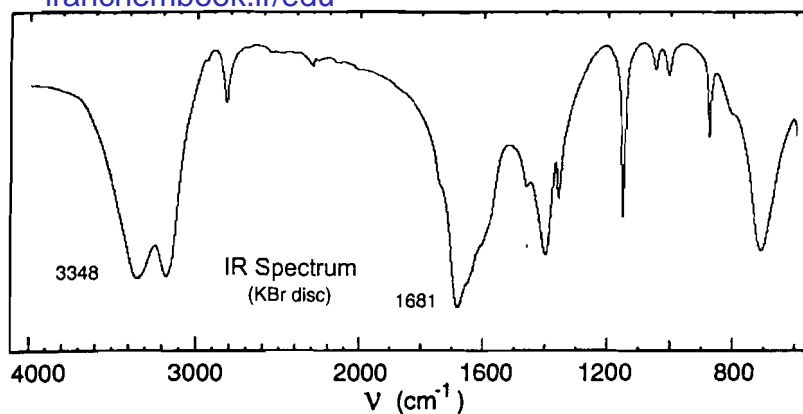

No significant UV  
absorption above 210 nm

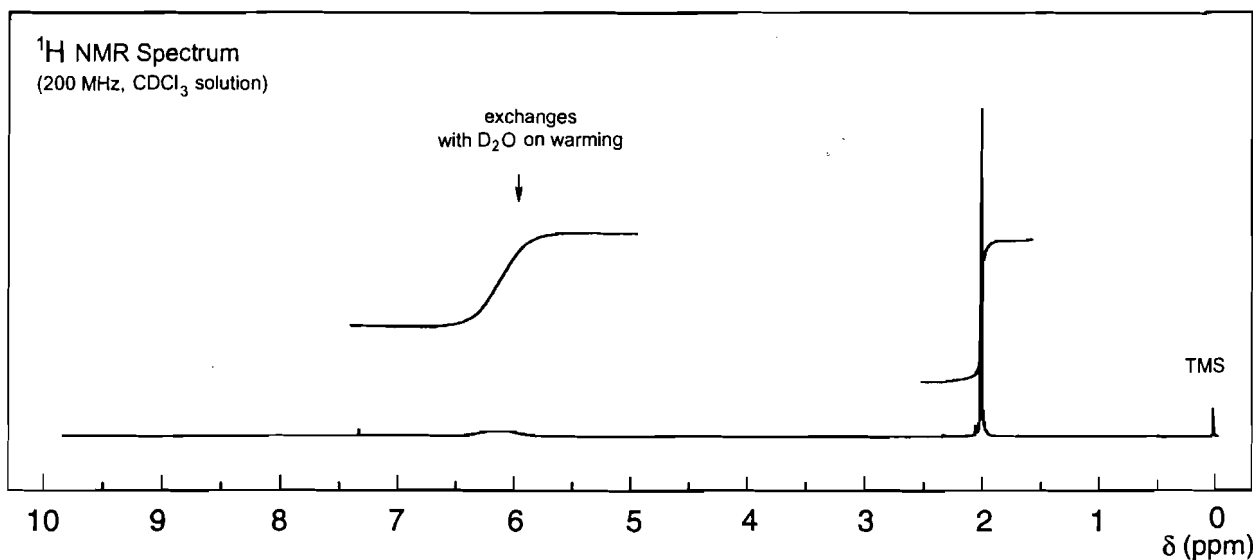
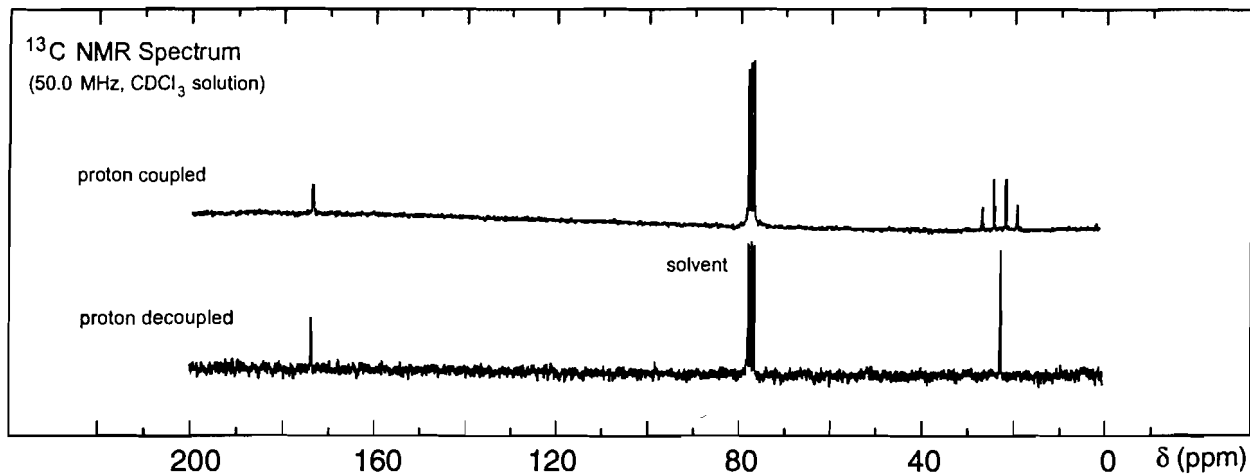

## Problem 67

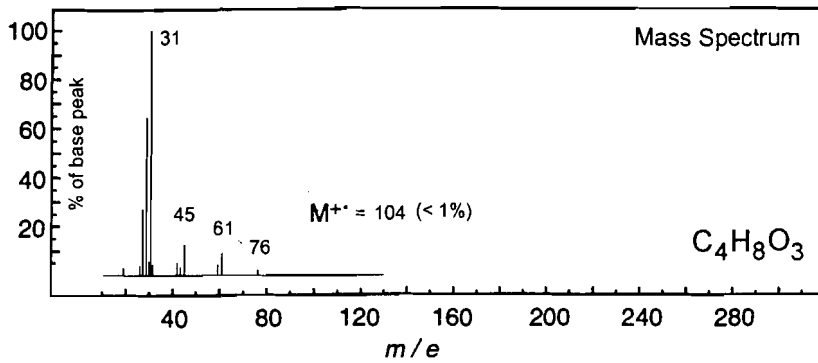
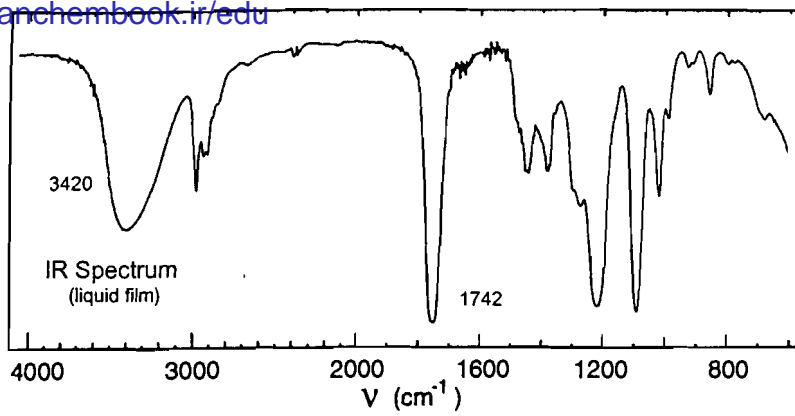

No significant UV  
absorption above 220 nm

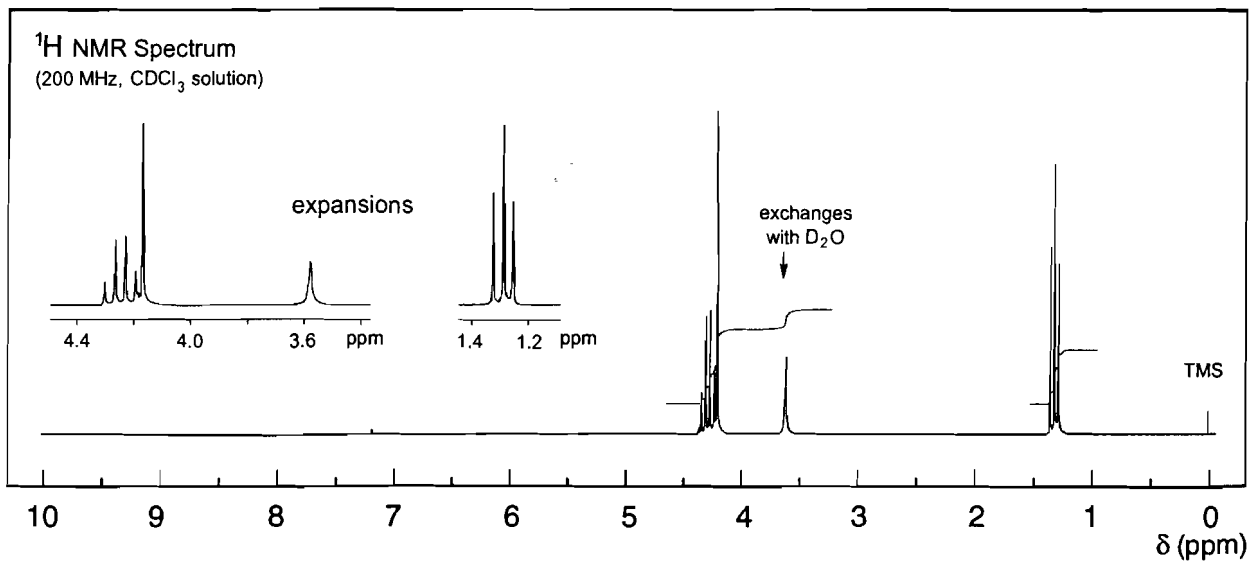
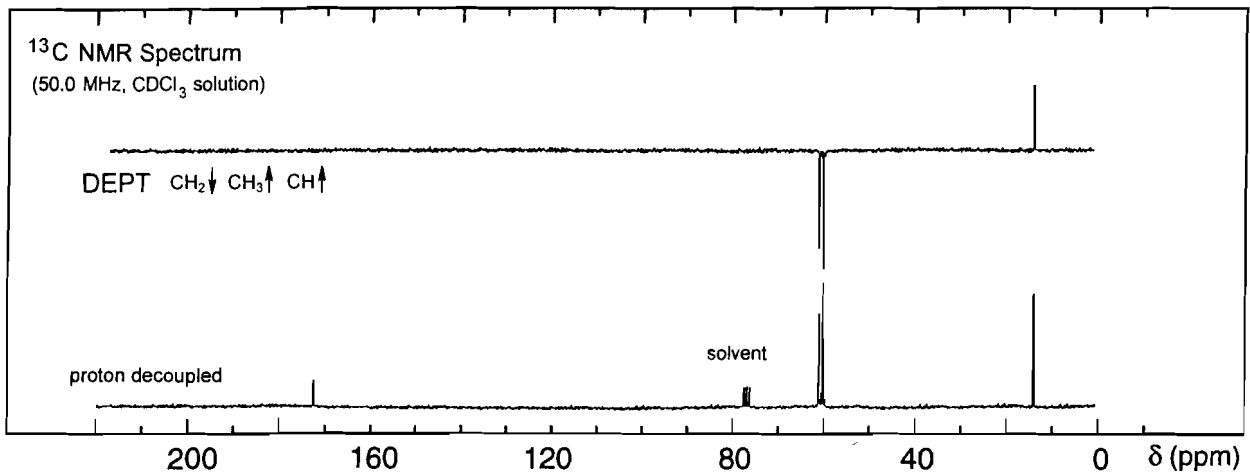

## Problem 68

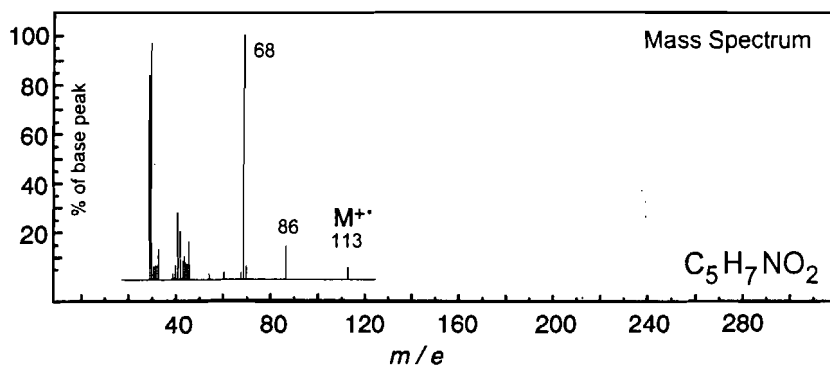
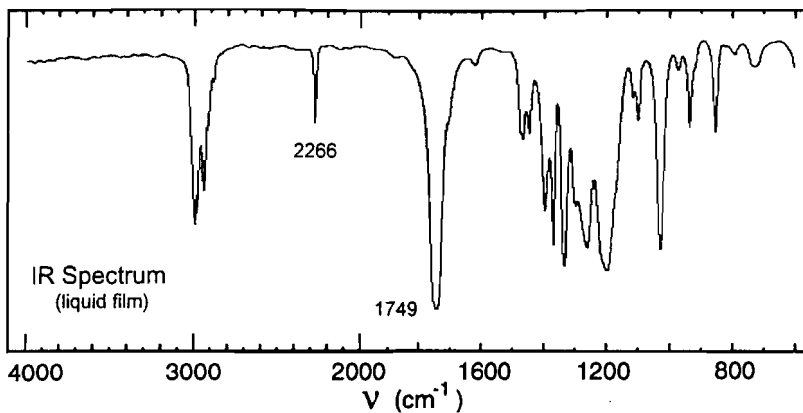

No significant UV  
absorption above 220 nm

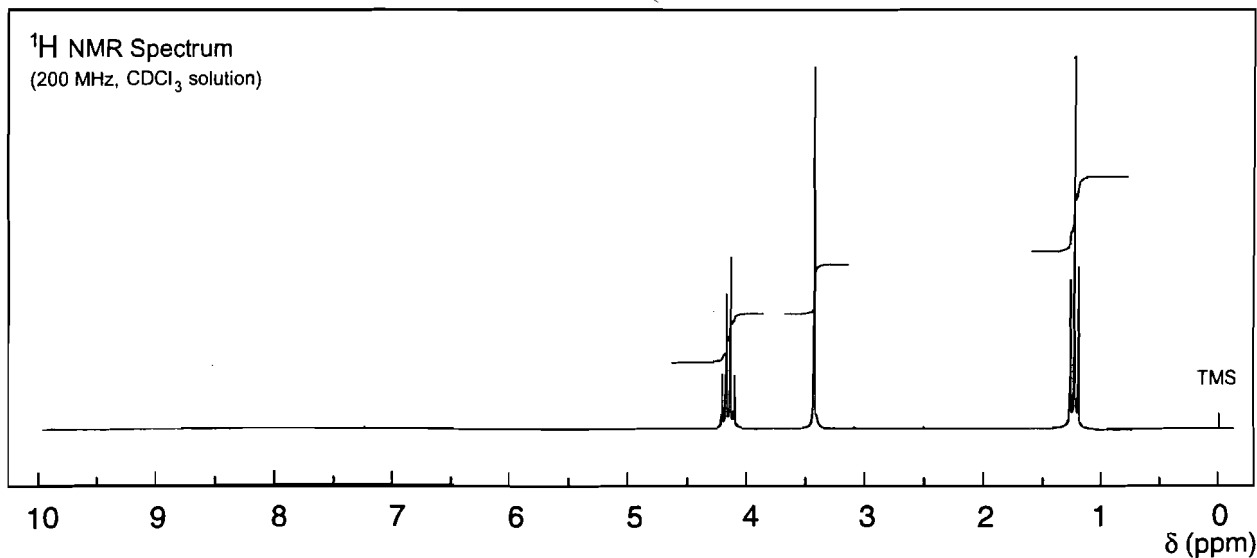
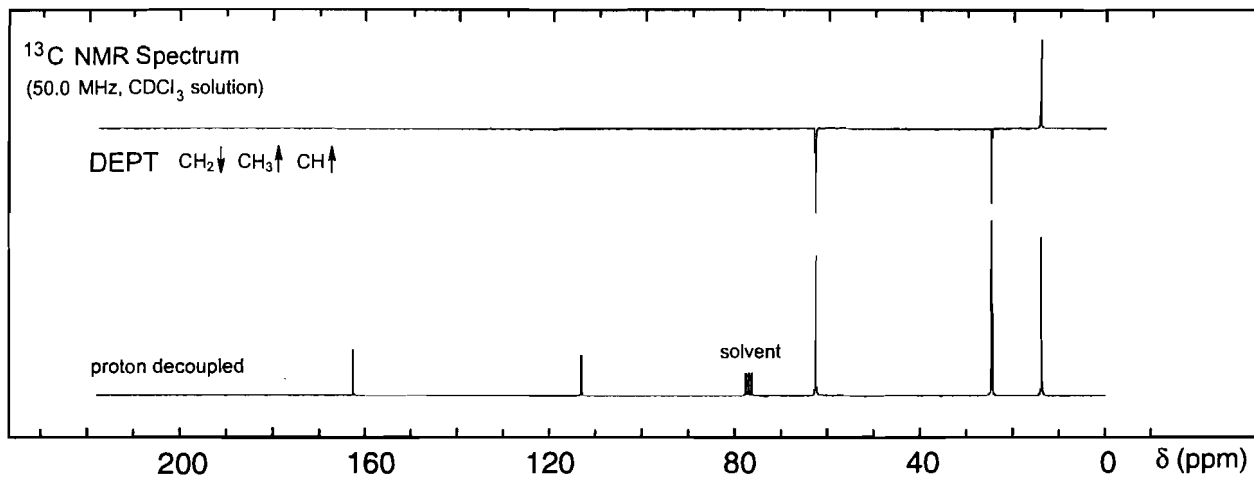

# Problem 69

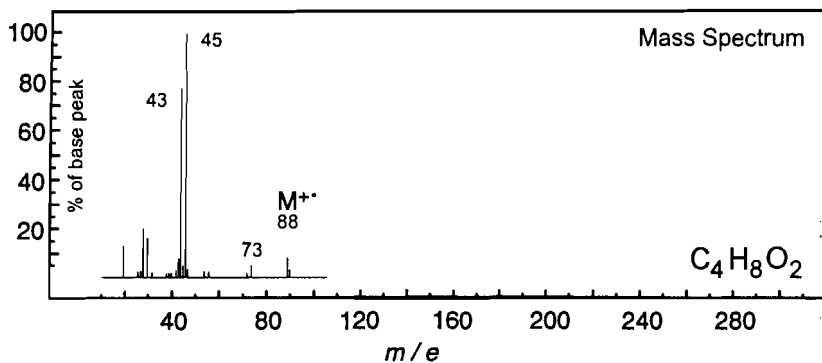
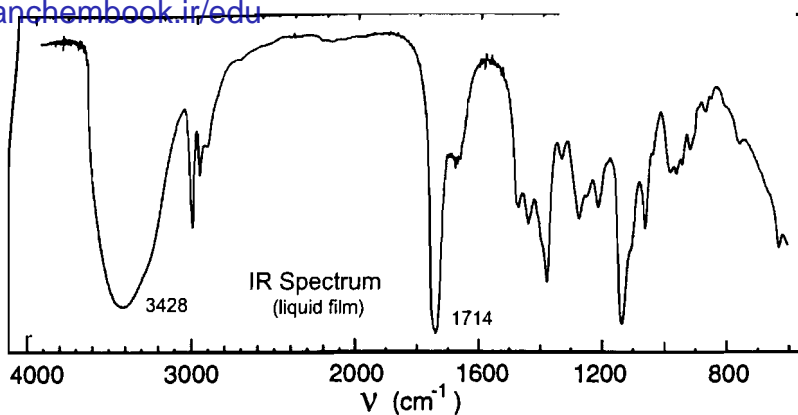

No strong UV absorption above 220 nm

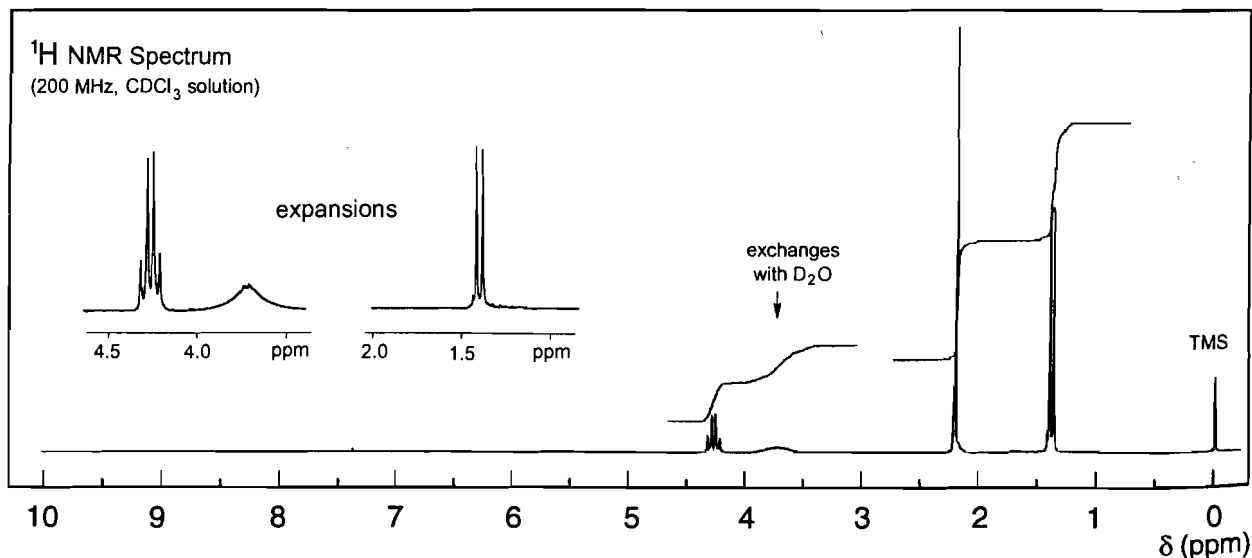
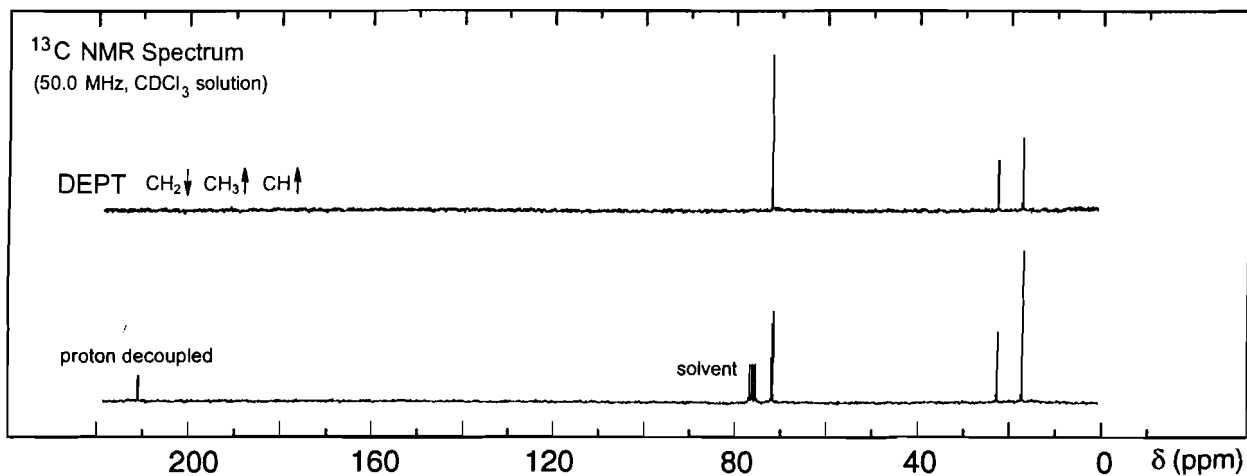

## Problem 70

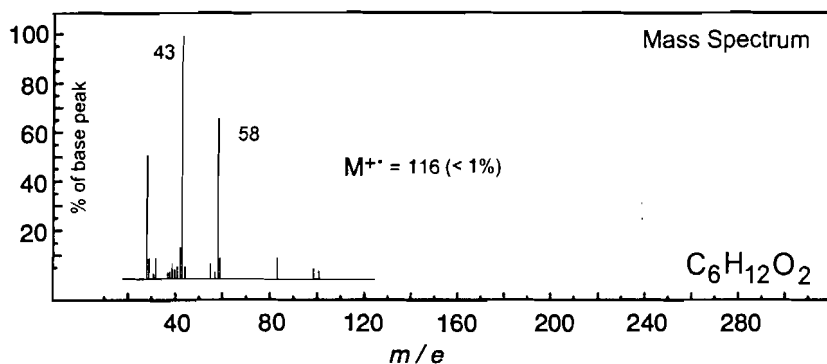
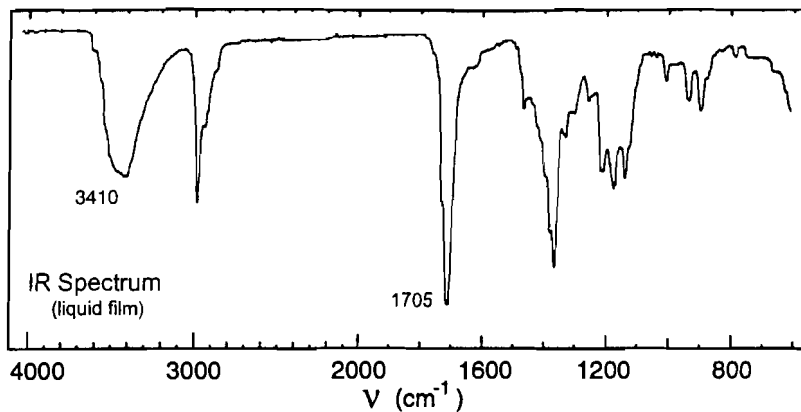

UV Spectrum

 $\lambda_{\text{max}} 283 \text{ nm}$  ( $\log_{10} \epsilon 1.4$ )

solvent : hexane

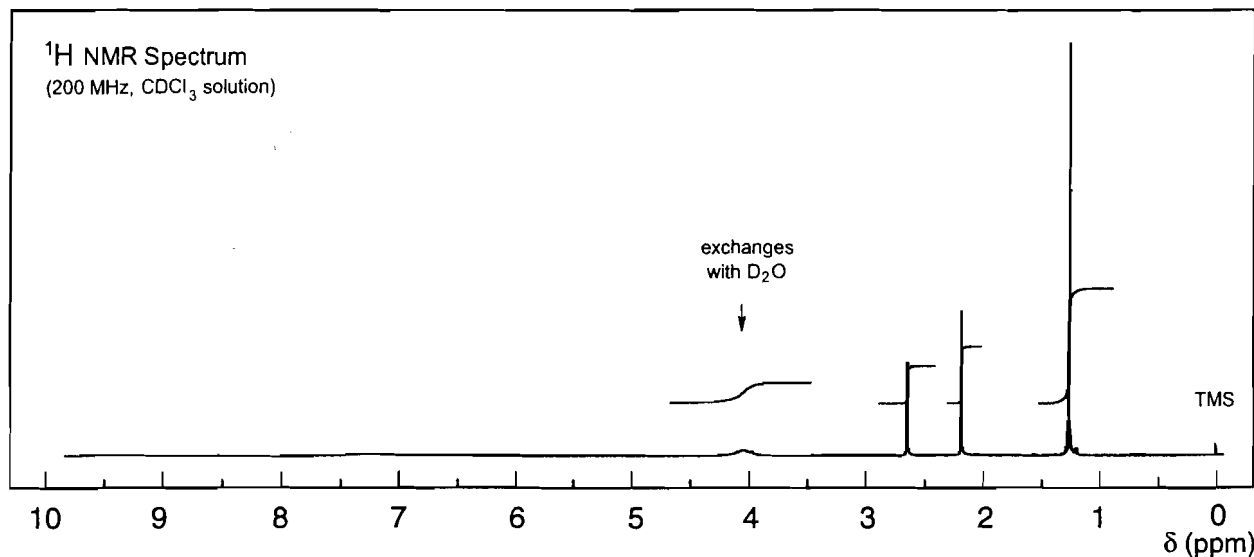
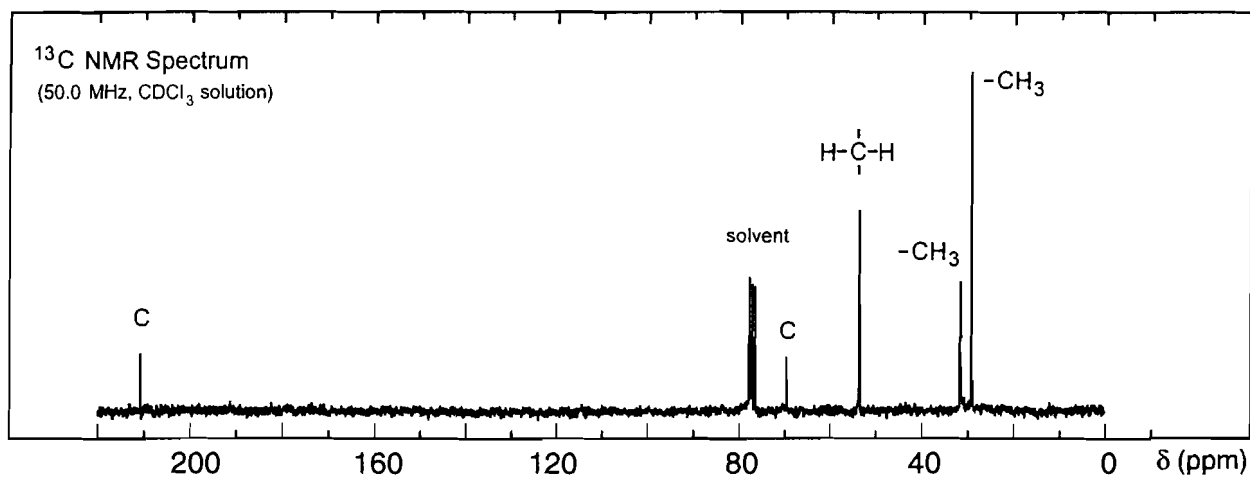



## Problem 71

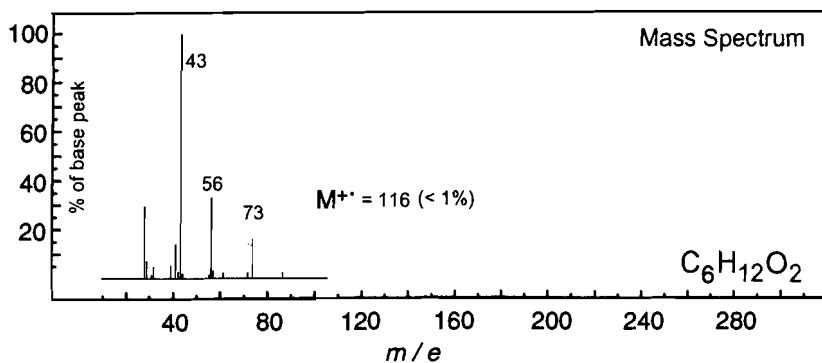
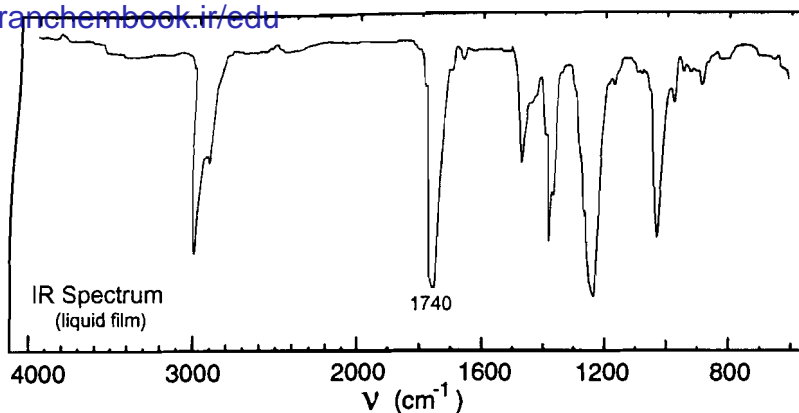

No significant UV  
absorption above 220 nm

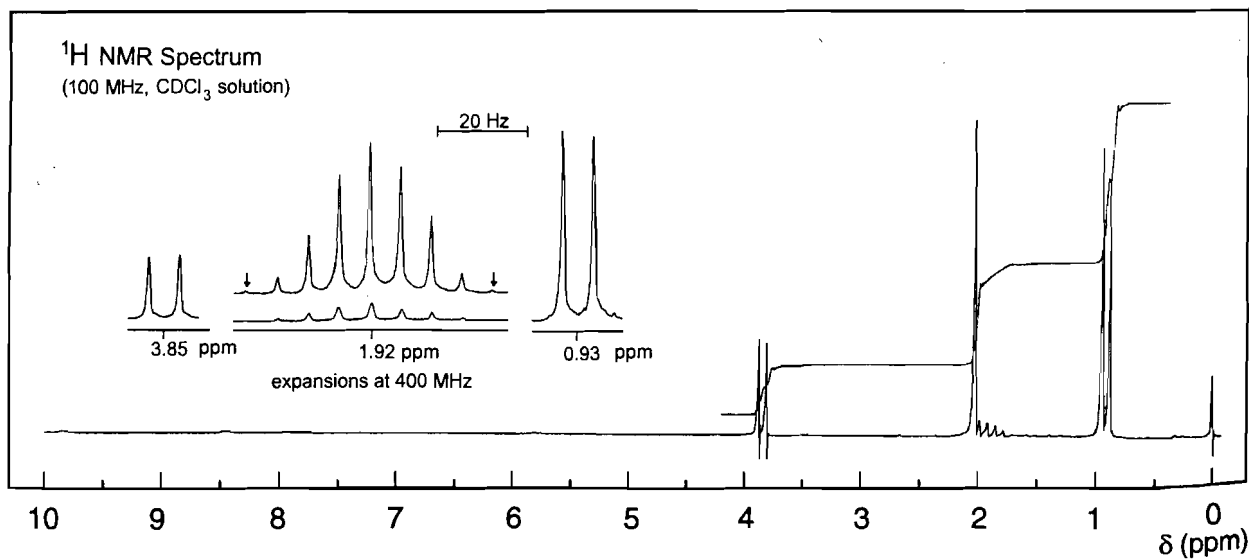
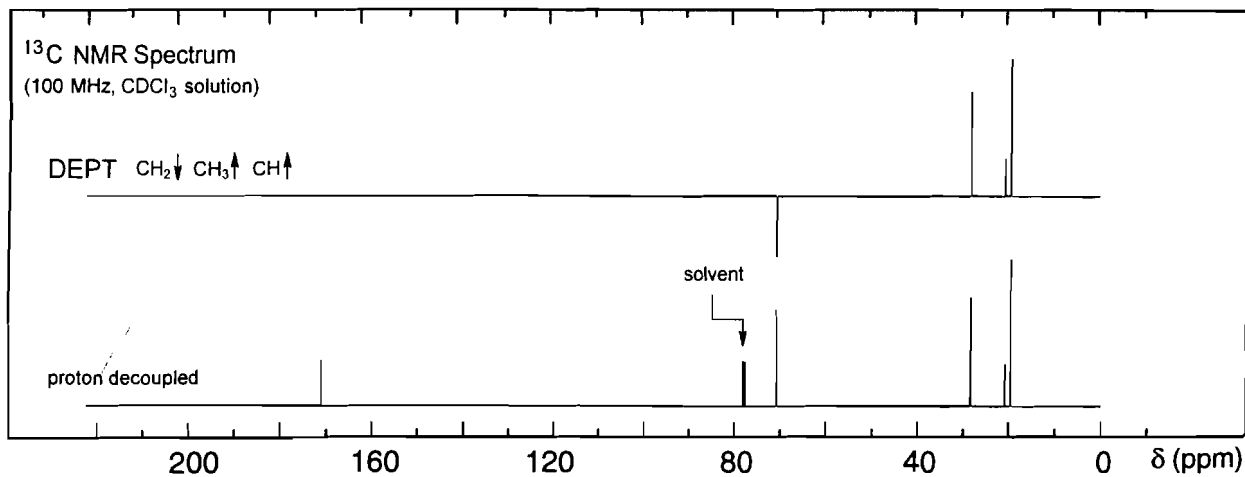

## Problem 72

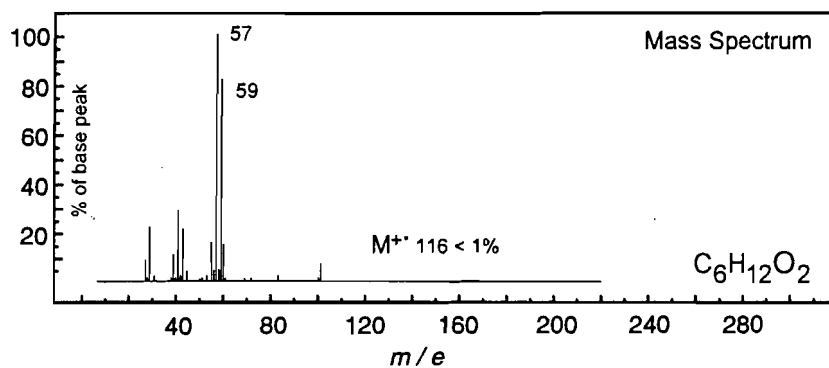
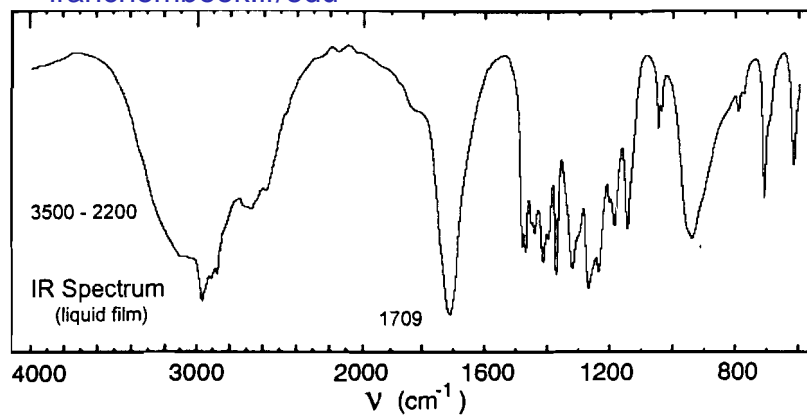

No significant UV  
absorption above 220 nm

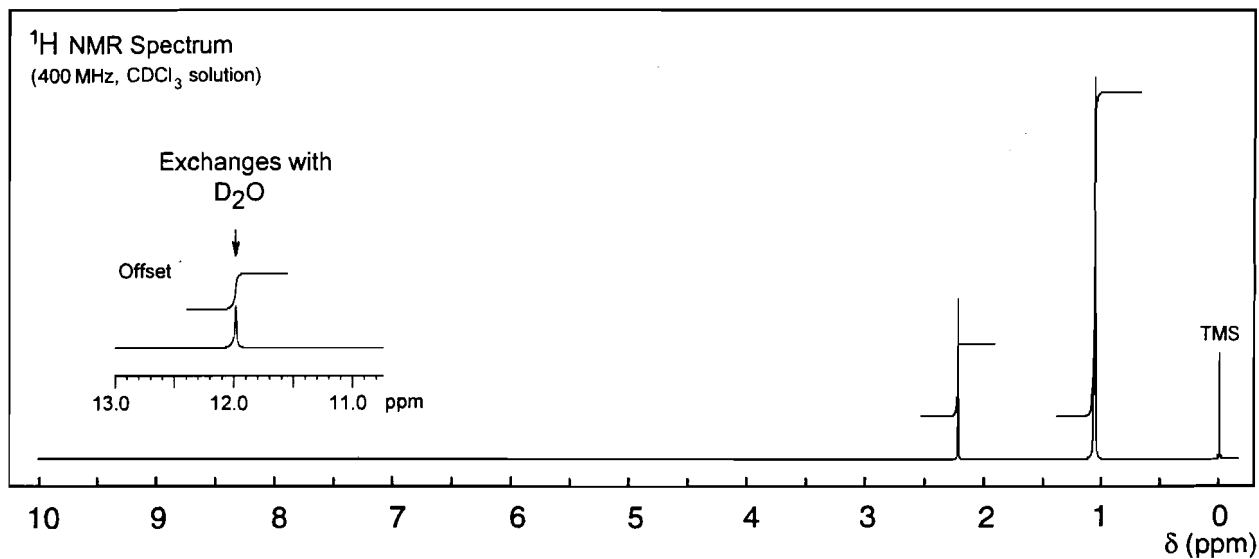
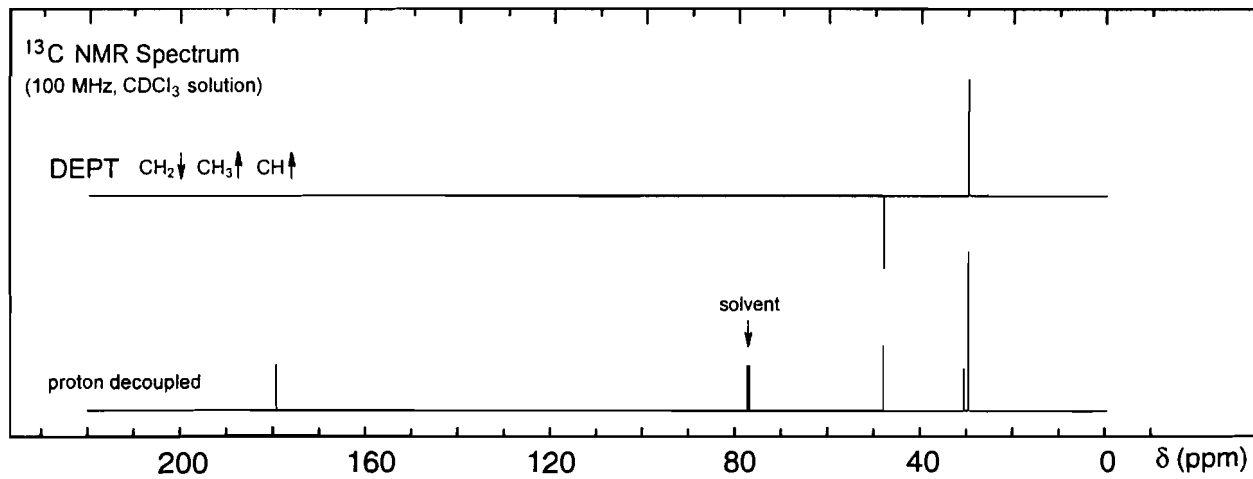

## Problem 73

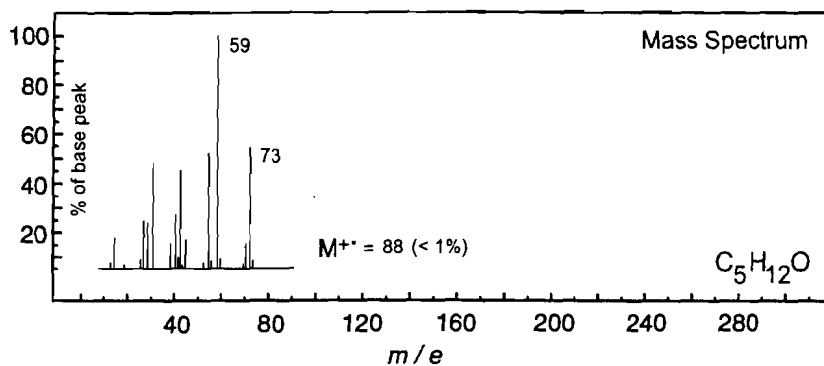
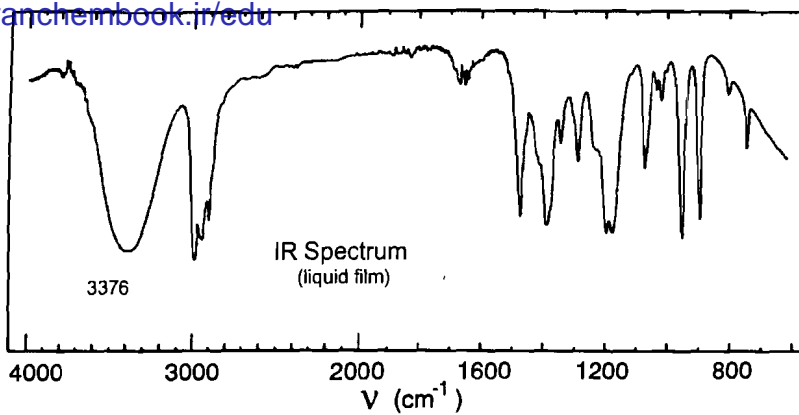

No significant UV  
absorption above 220 nm

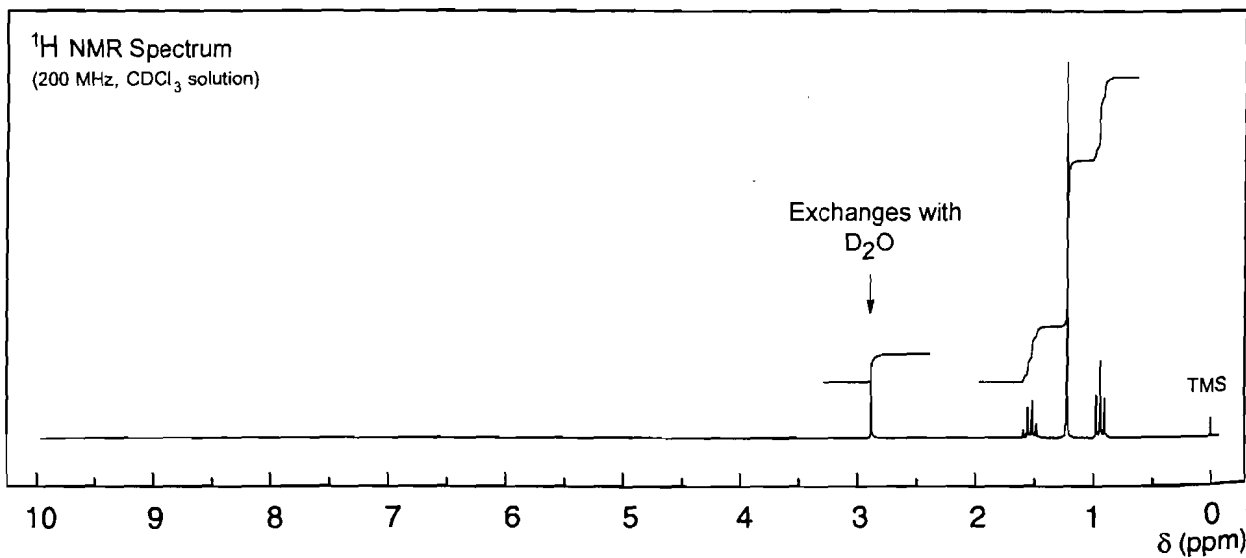
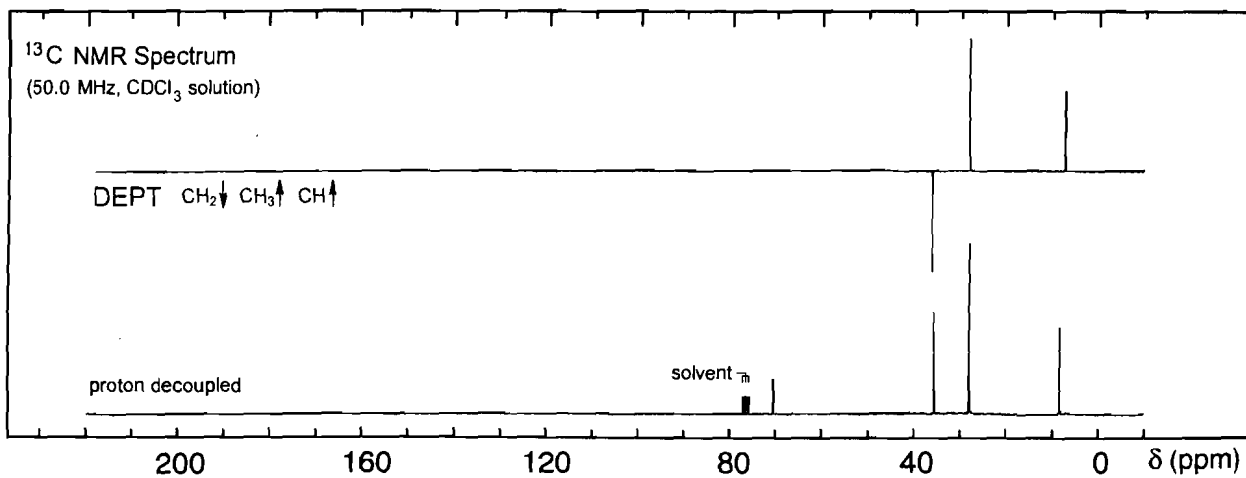

## Problem 74

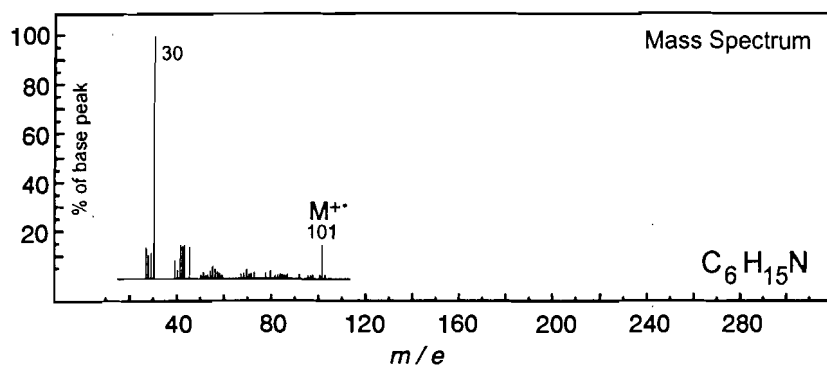
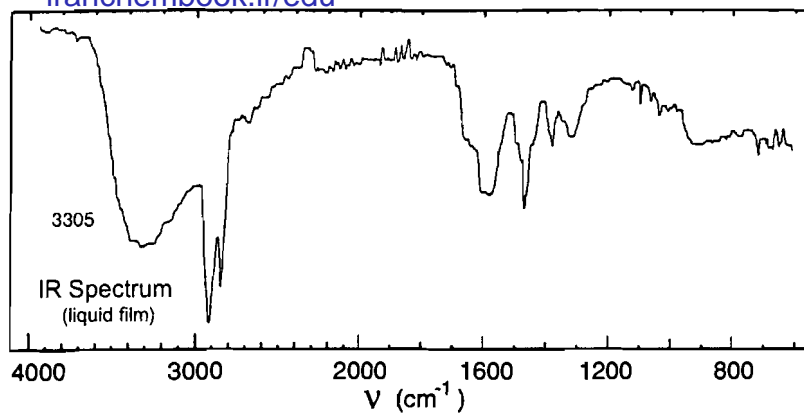

No significant UV  
absorption above 220 nm

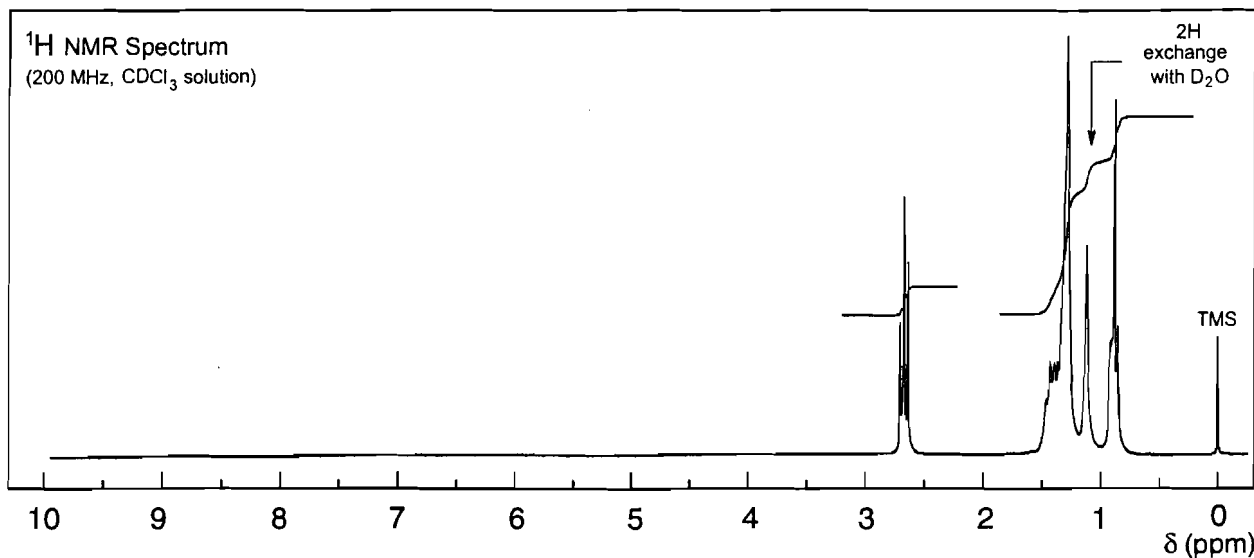
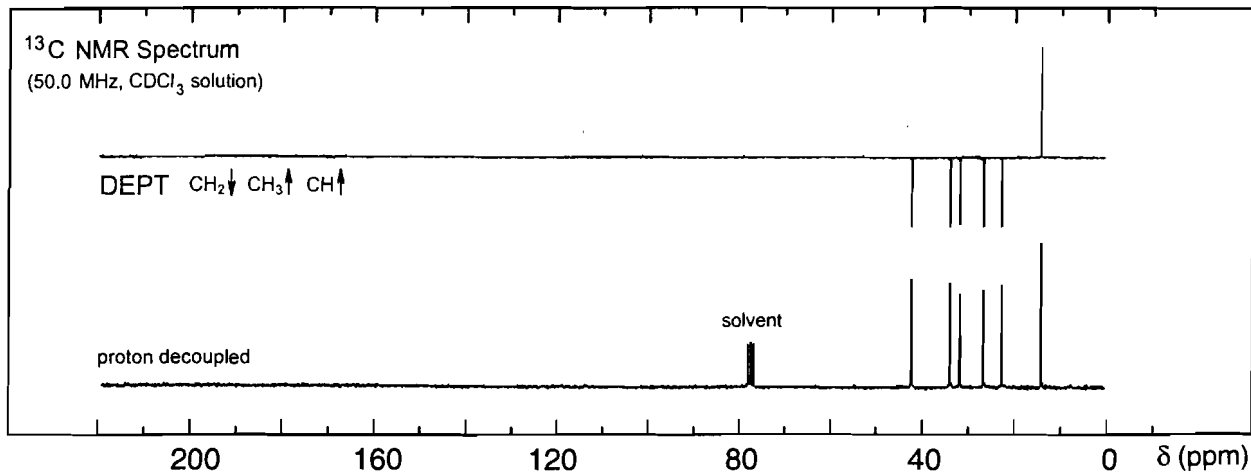

# Problem 75

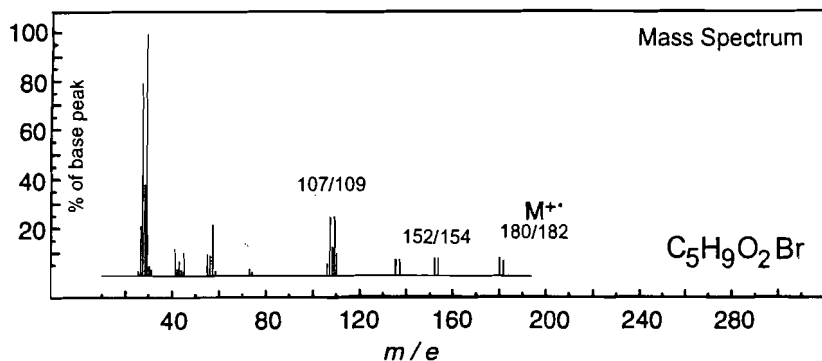
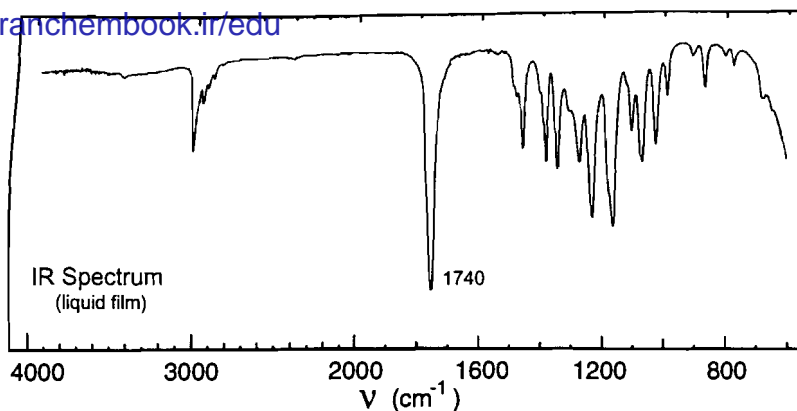

No significant UV  
absorption above 220 nm

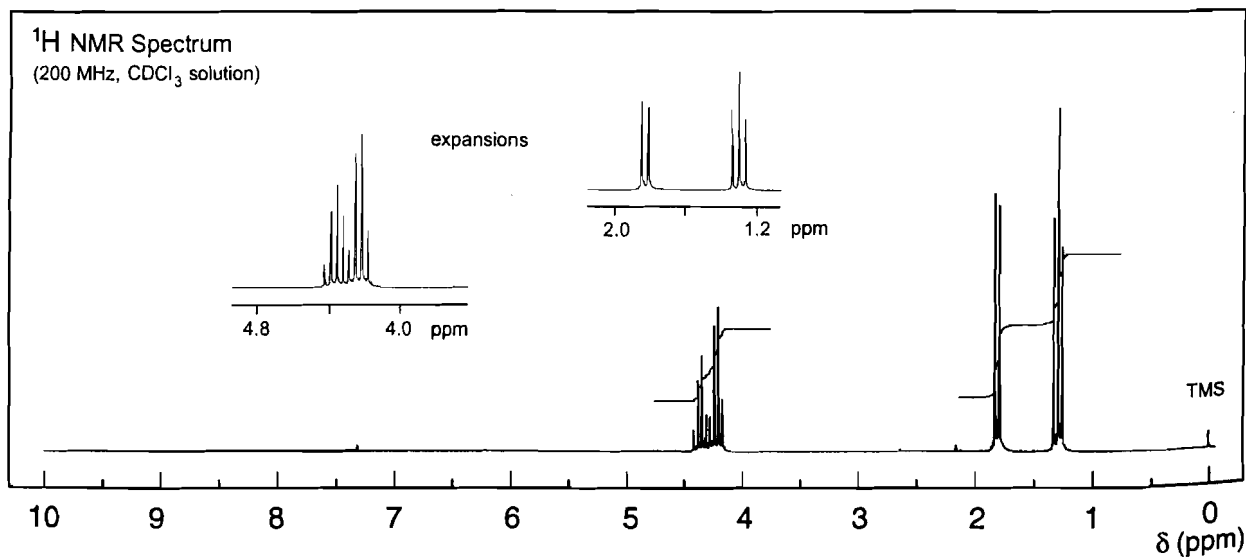
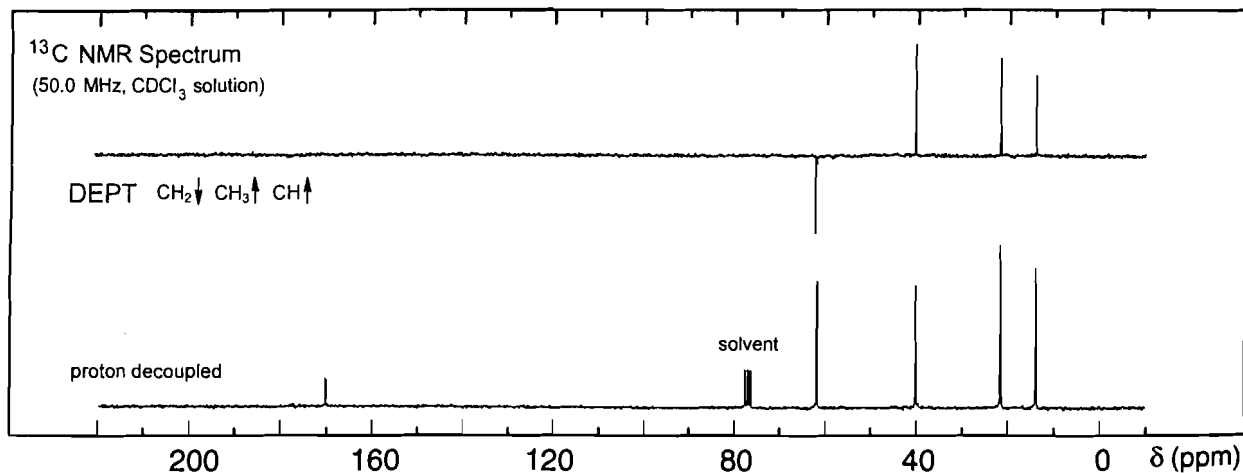

# Problem 76

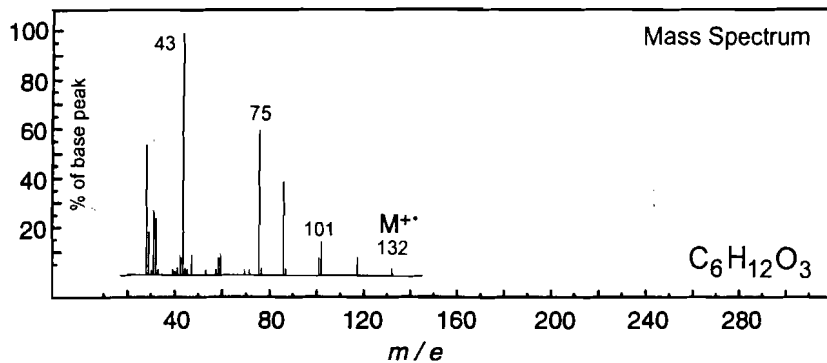
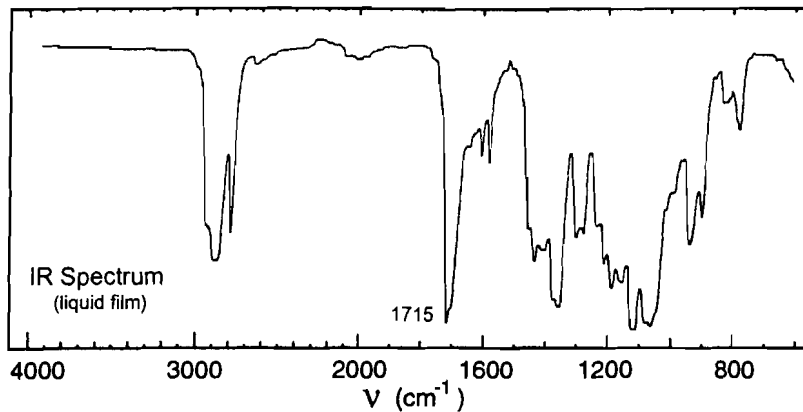

No significant UV absorption above 220 nm

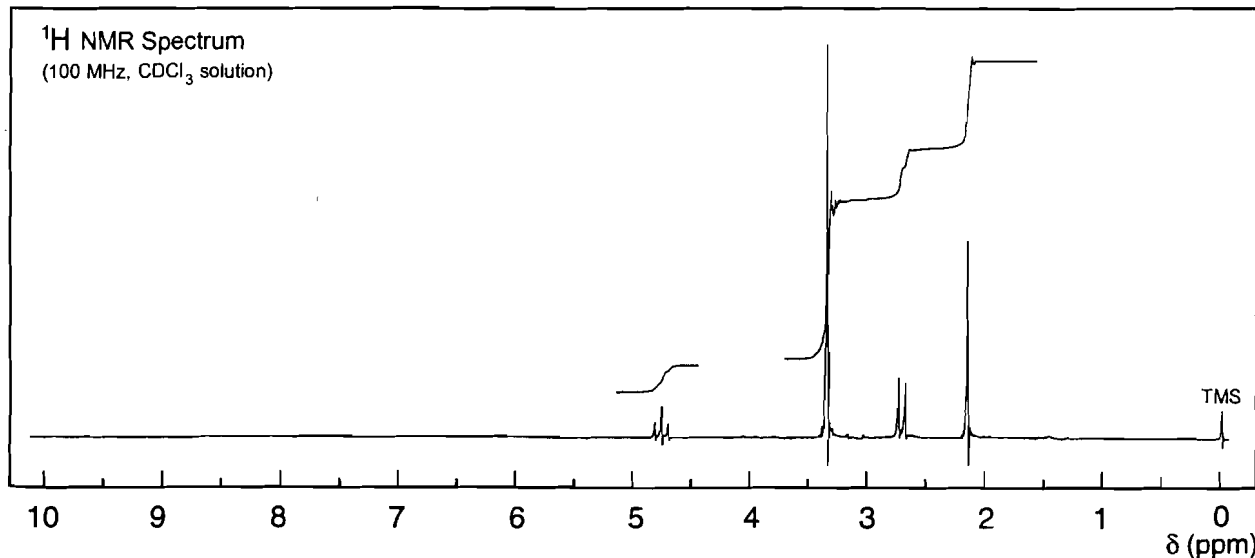
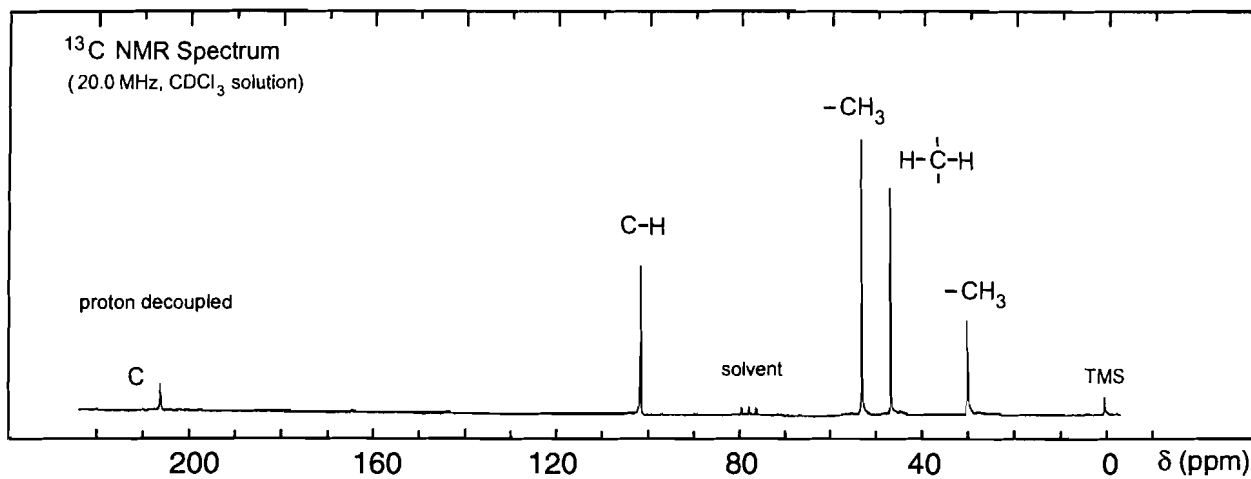

## Problem 77

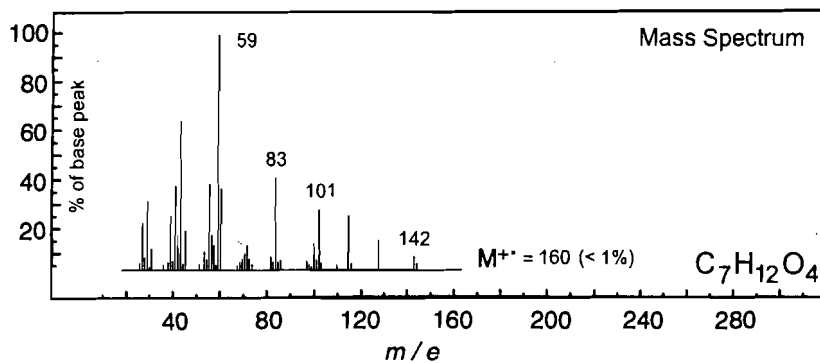
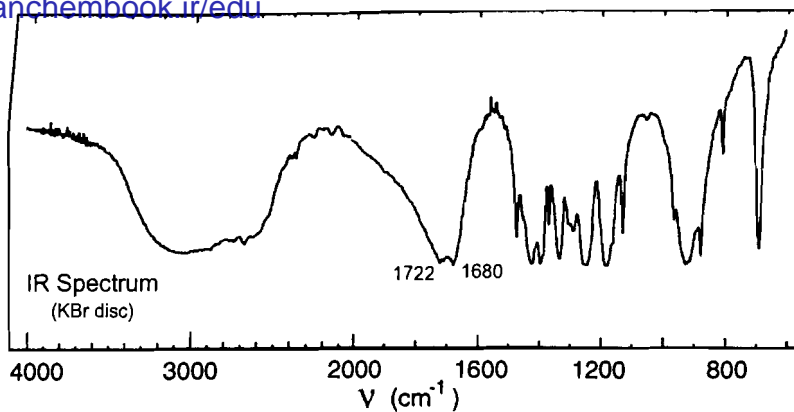

No significant UV  
absorption above 220 nm

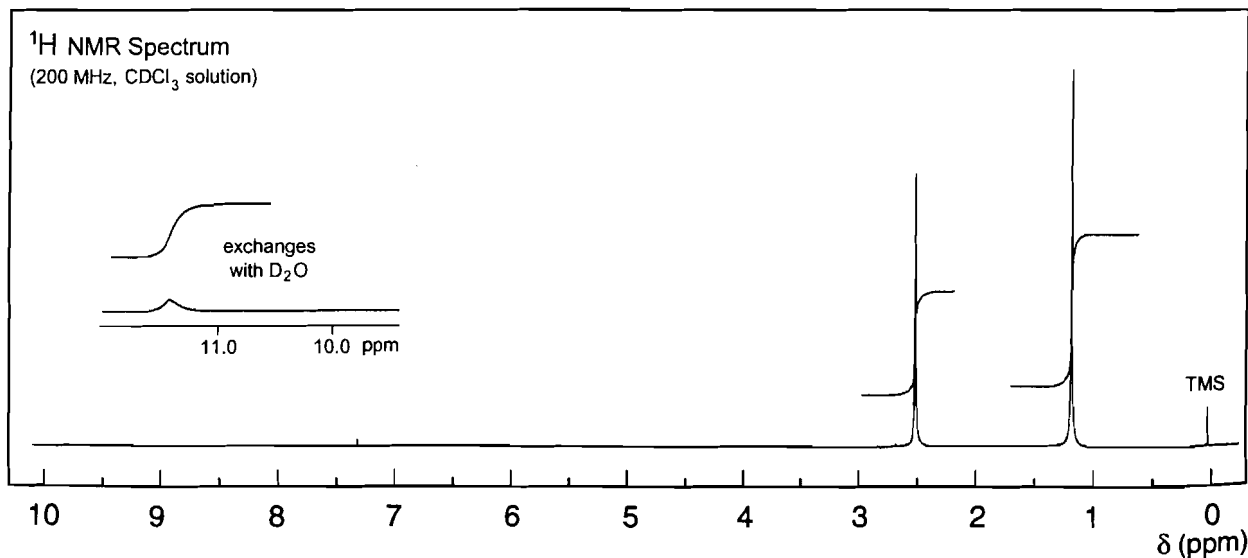
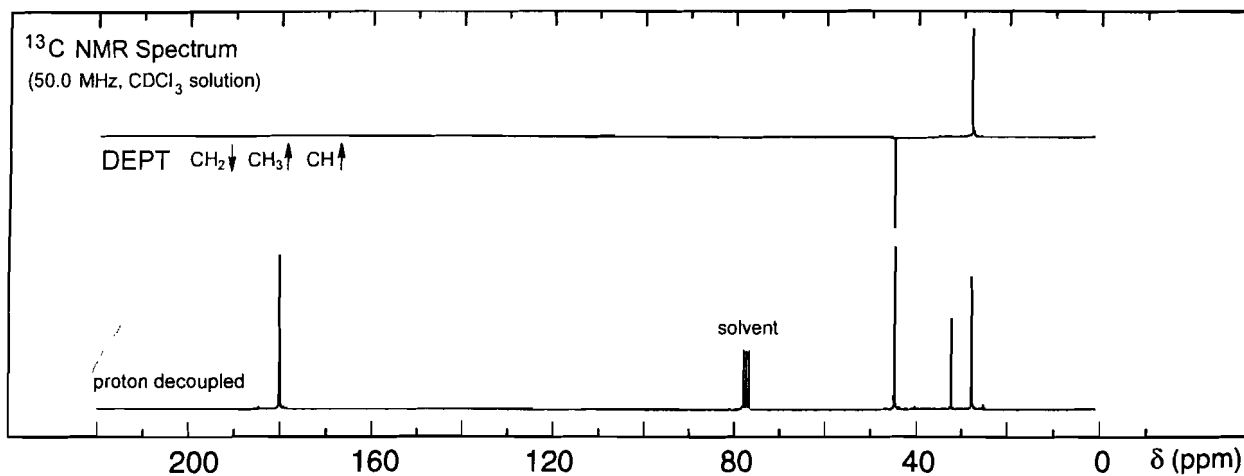

# Problem 78

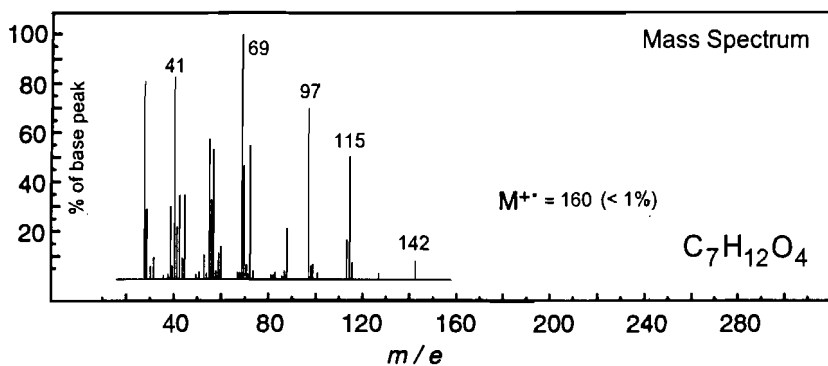
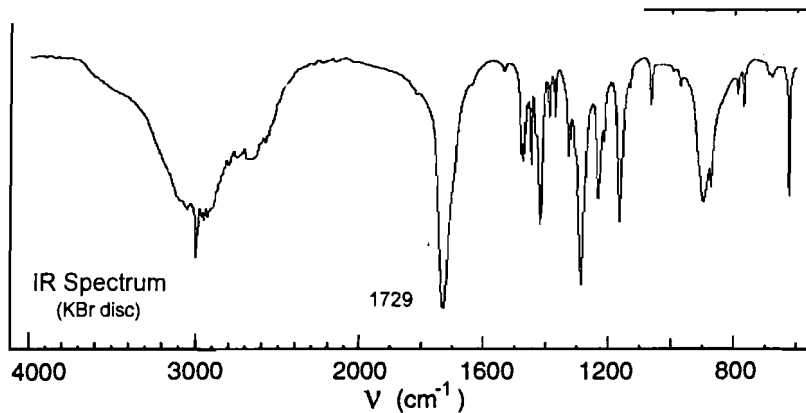

No significant UV absorption above 220 nm

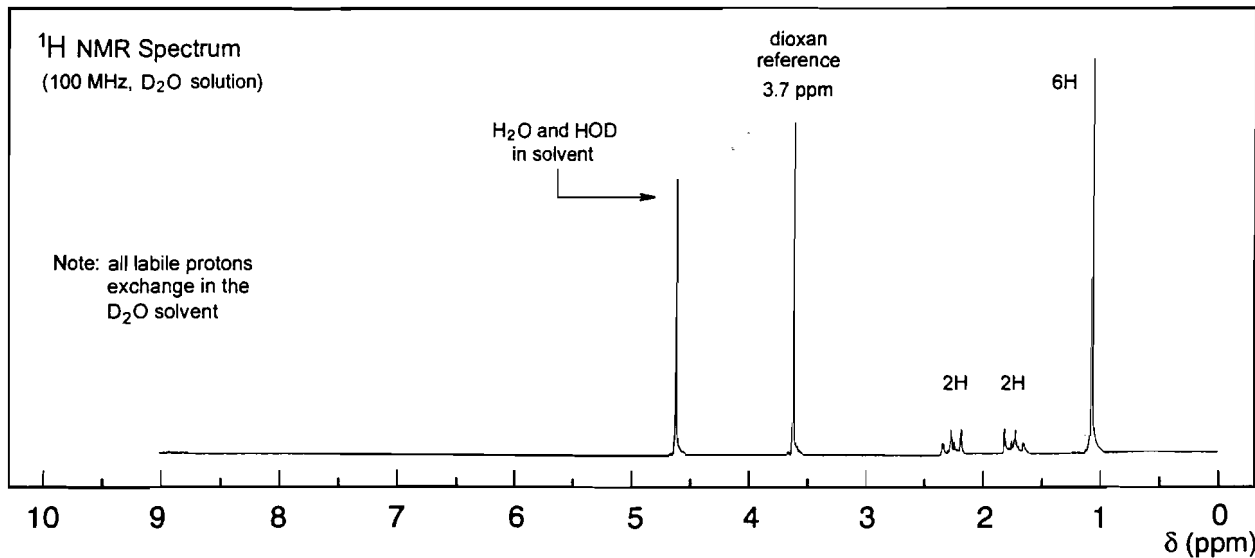
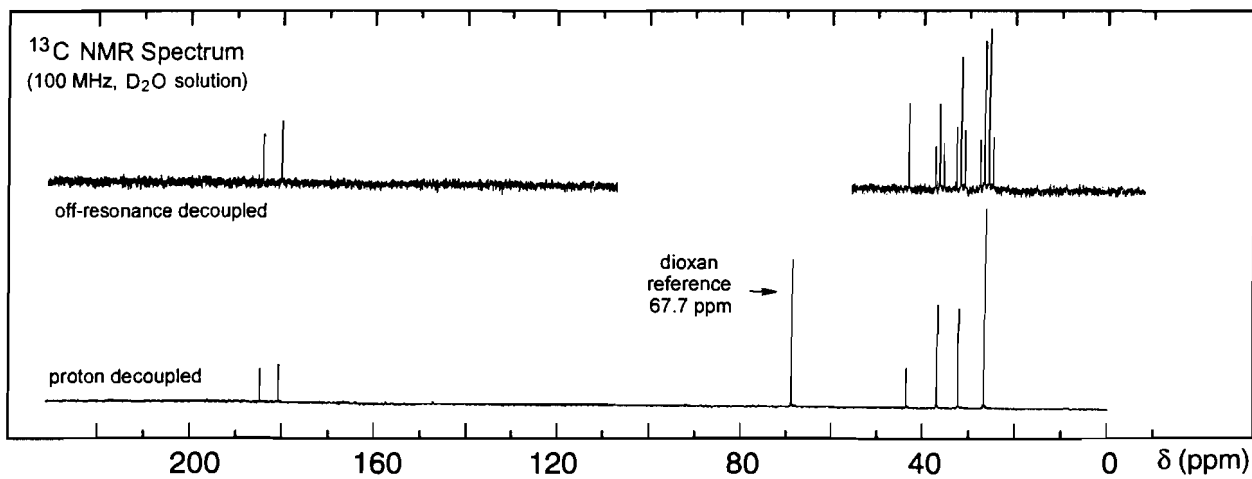



## Problem 79

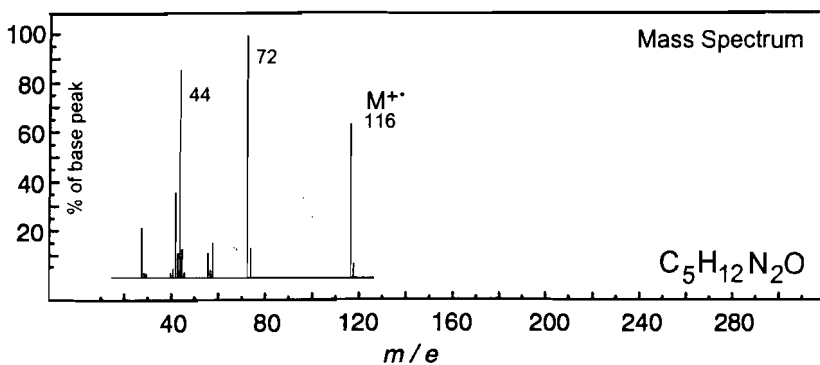
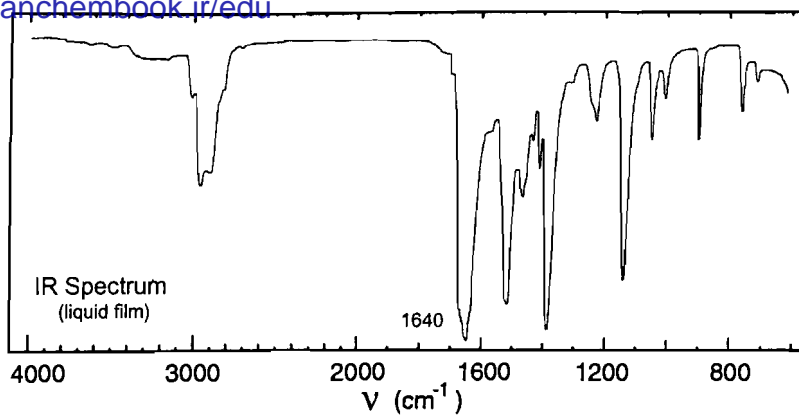

No significant UV  
absorption above 220 nm

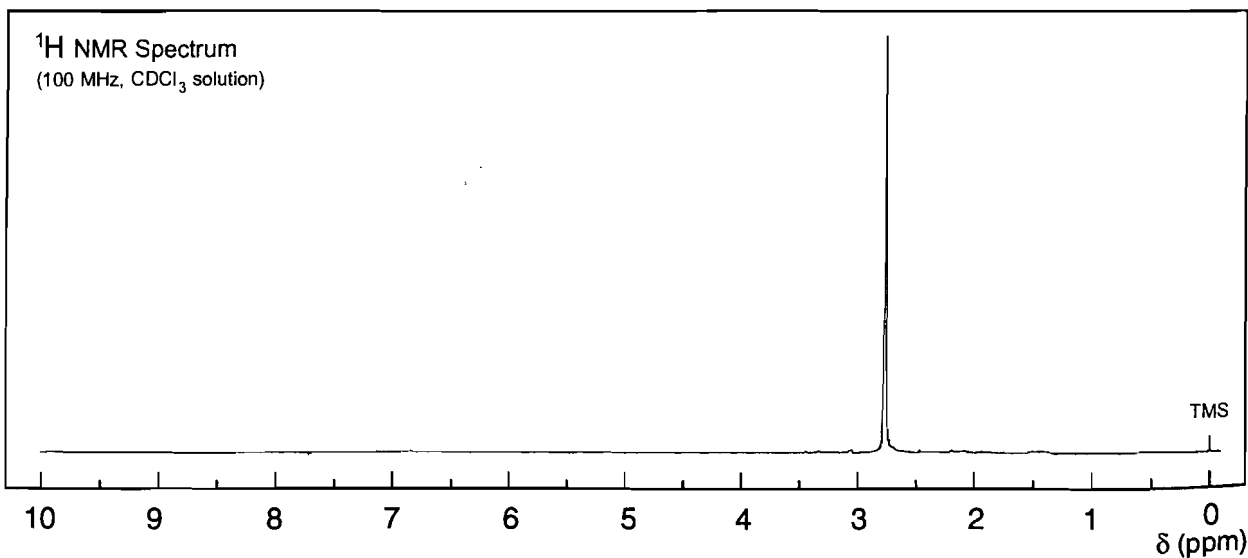
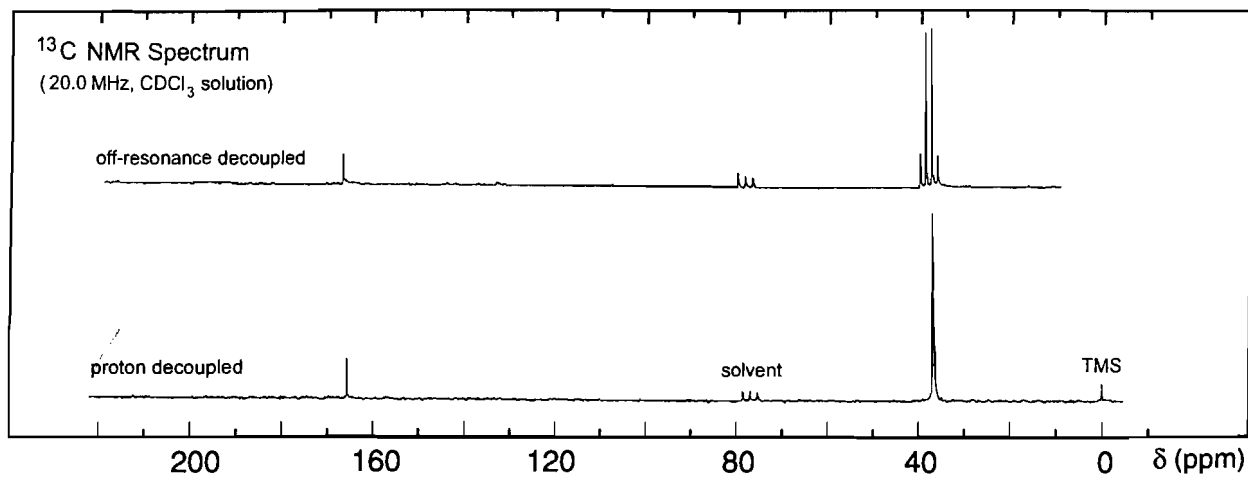

## Problem 80

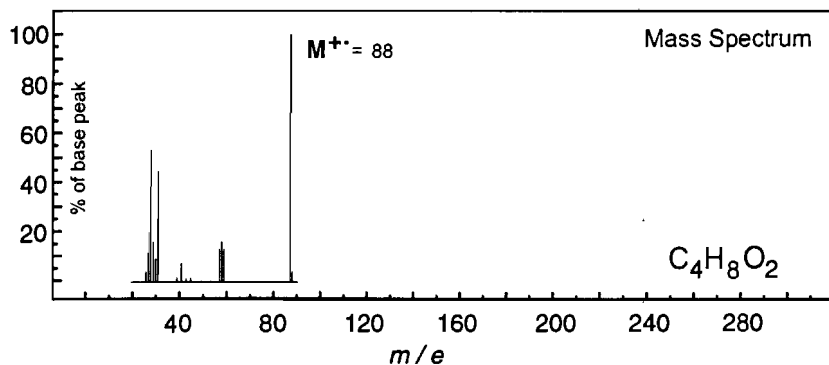
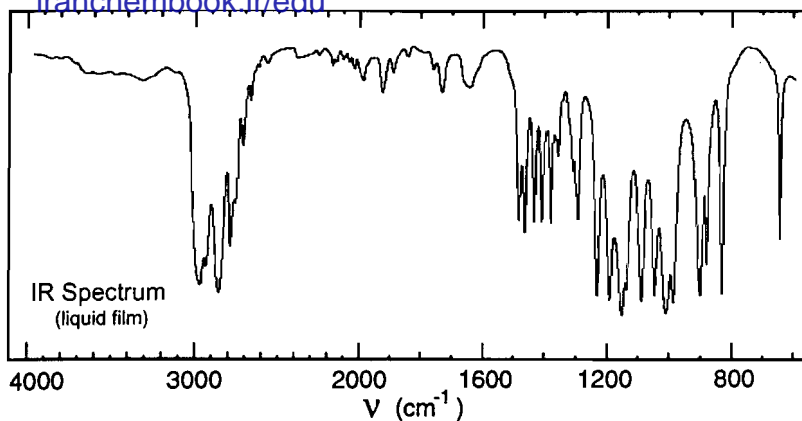

No significant UV  
absorption above 220 nm

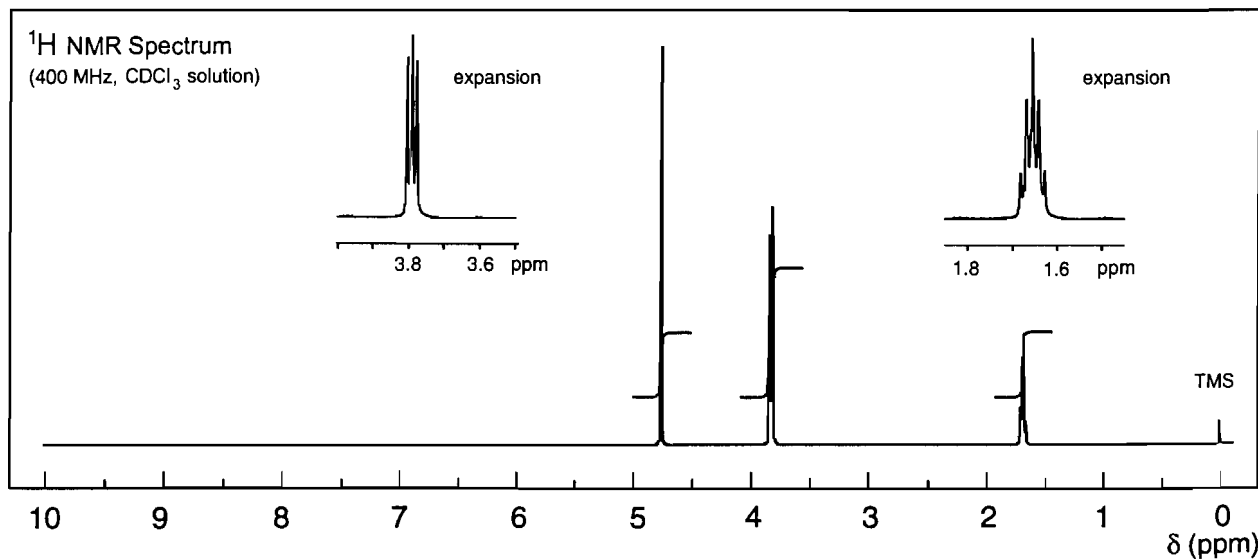
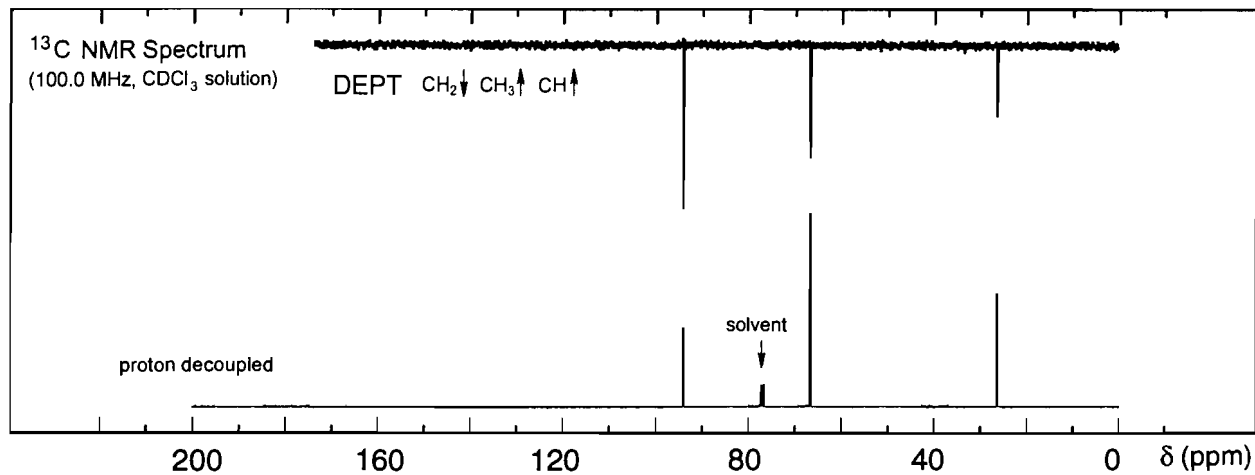

# Problem 81

iranchembook.ir/edu

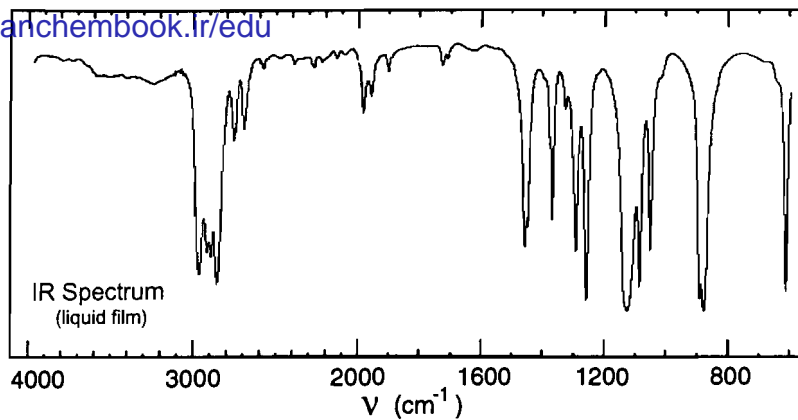

No significant UV  
absorption above 220 nm

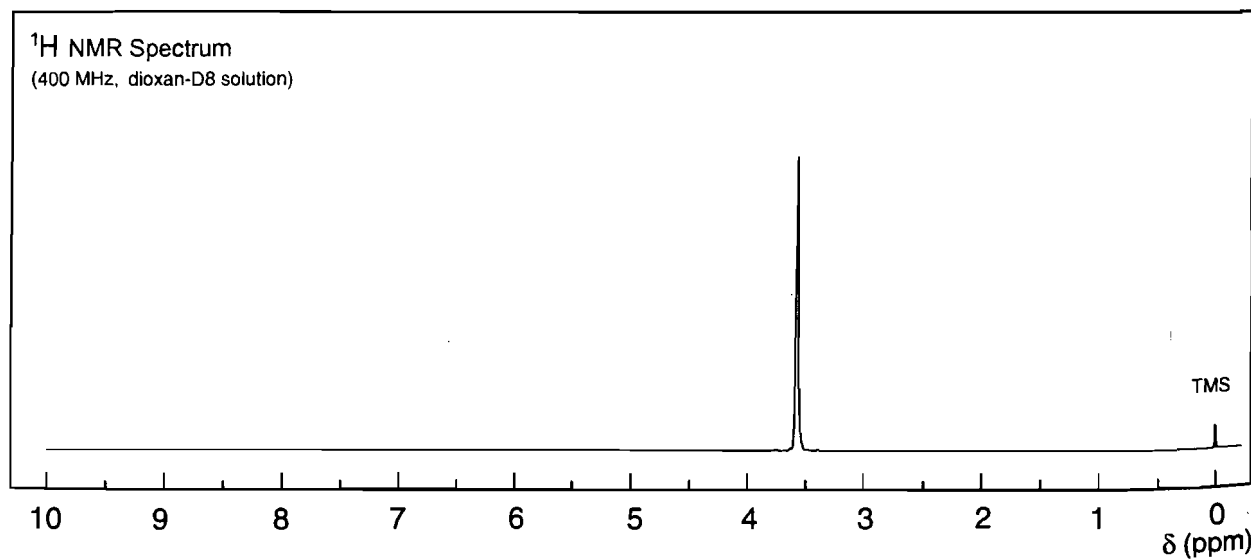
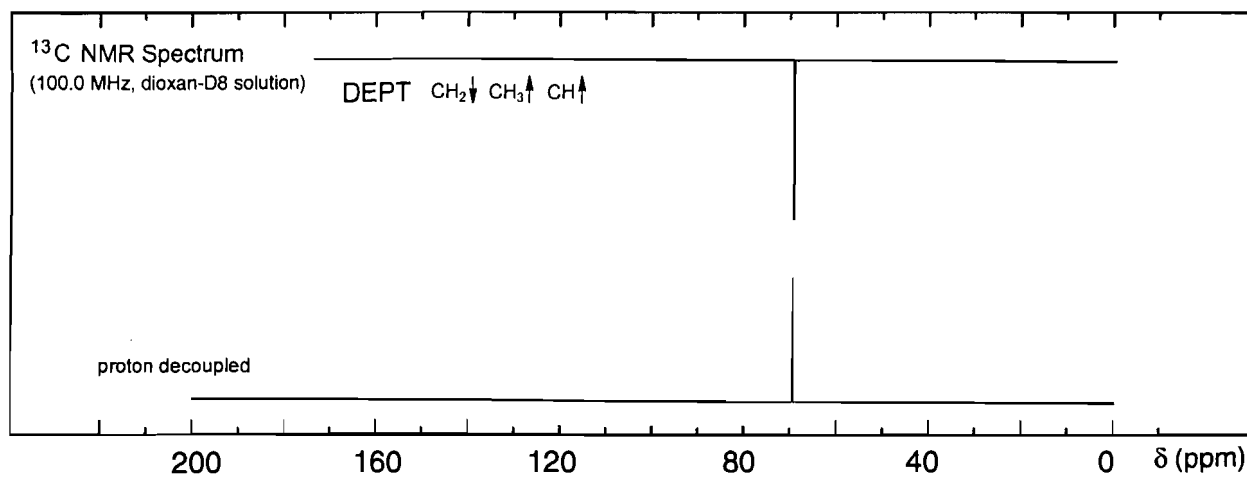
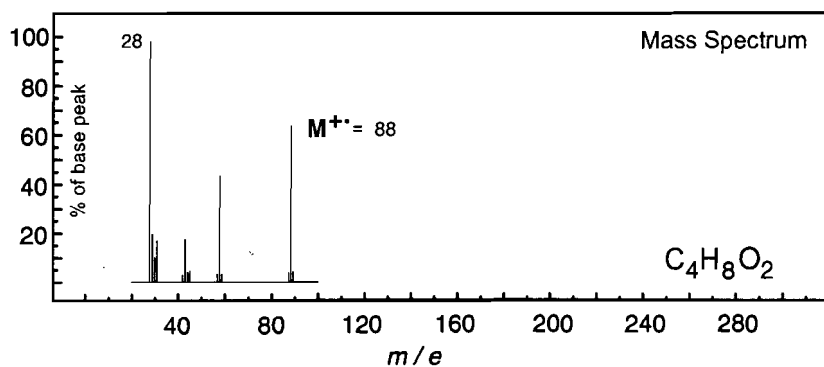

## Problem 82

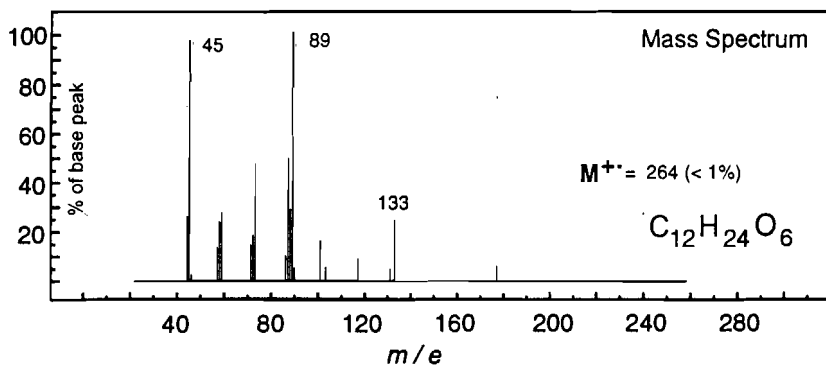
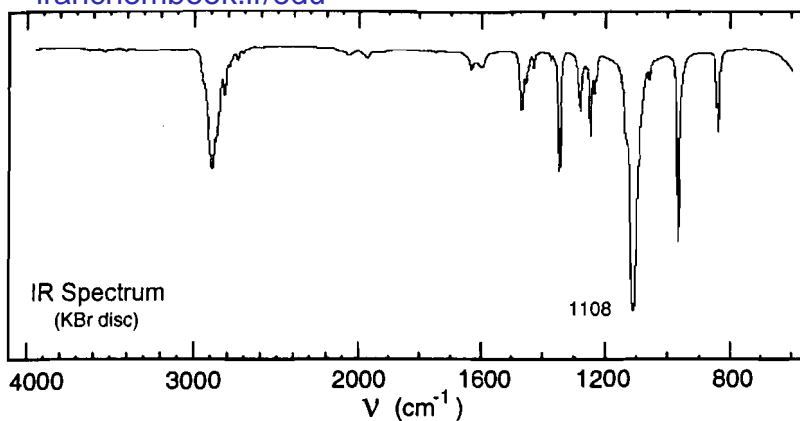

No significant UV  
absorption above 220 nm

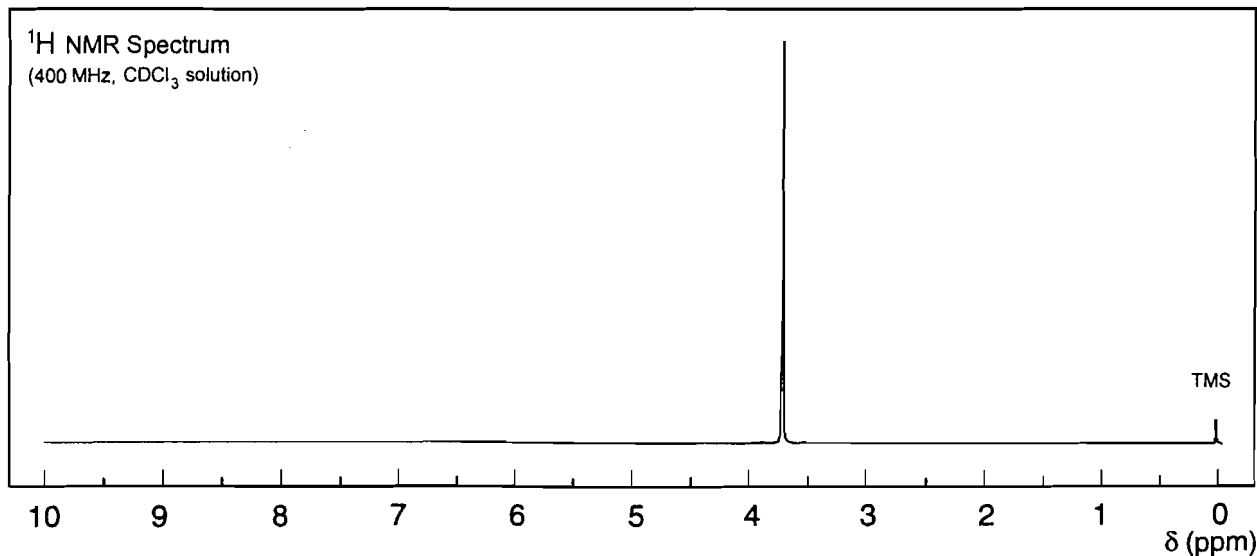
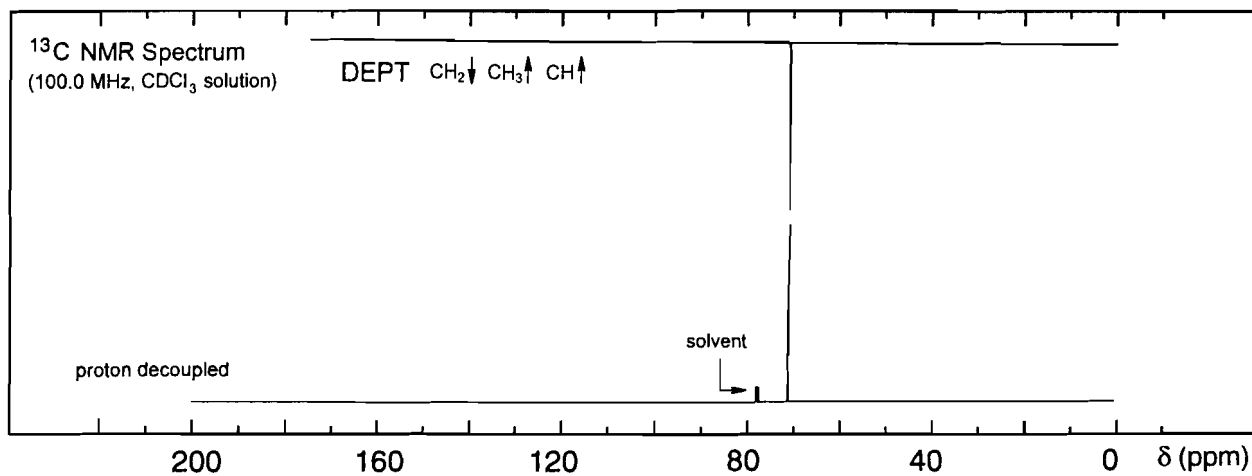

## Problem 83

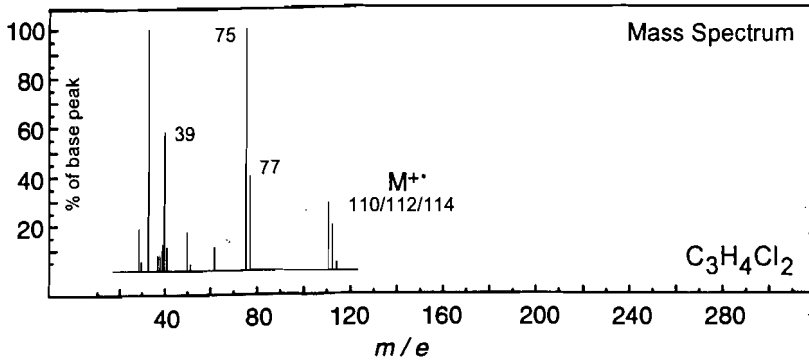
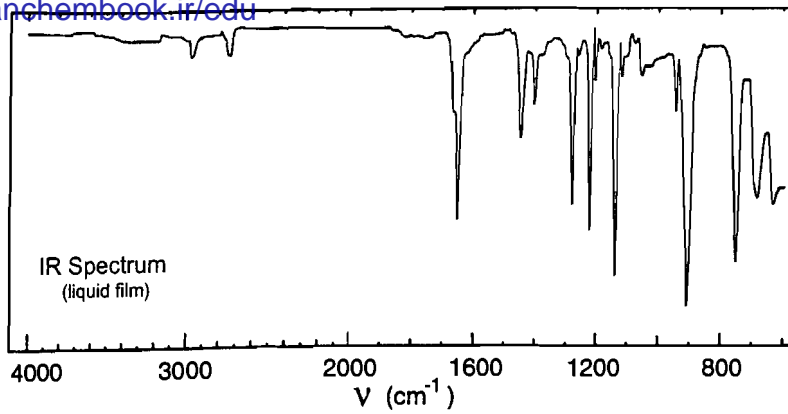

No significant UV  
absorption above 220 nm

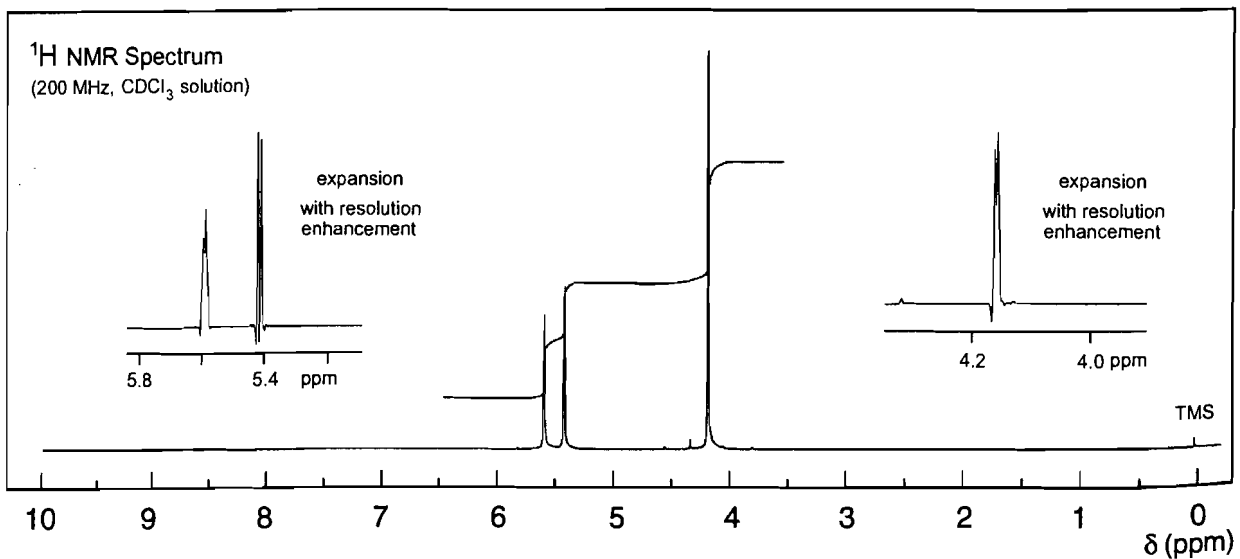
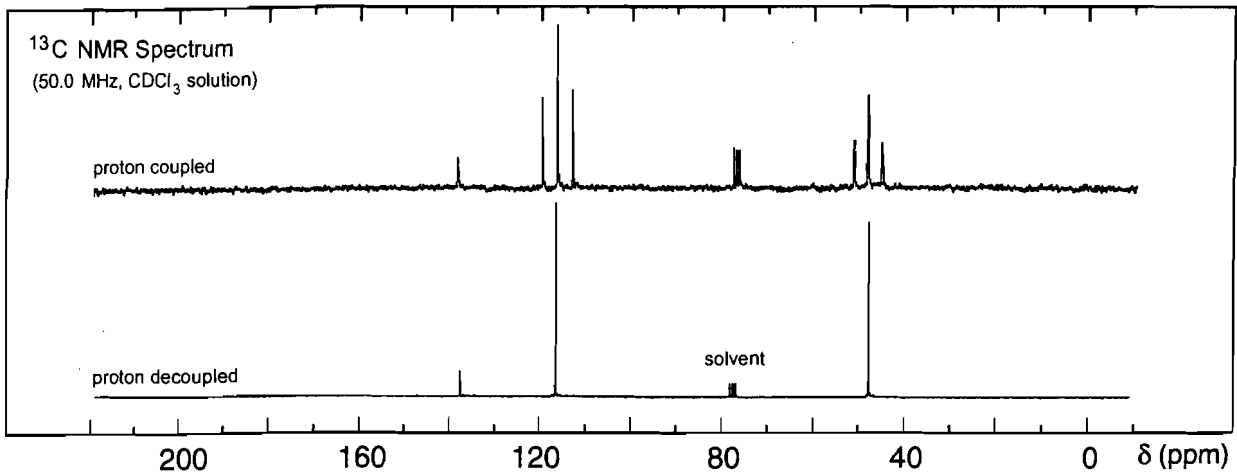

## Problem 84

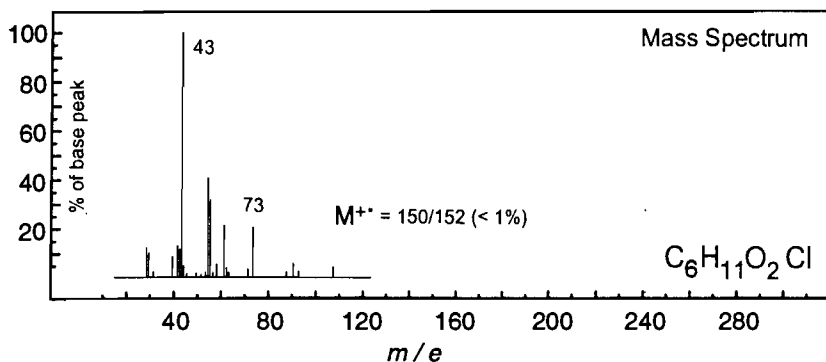
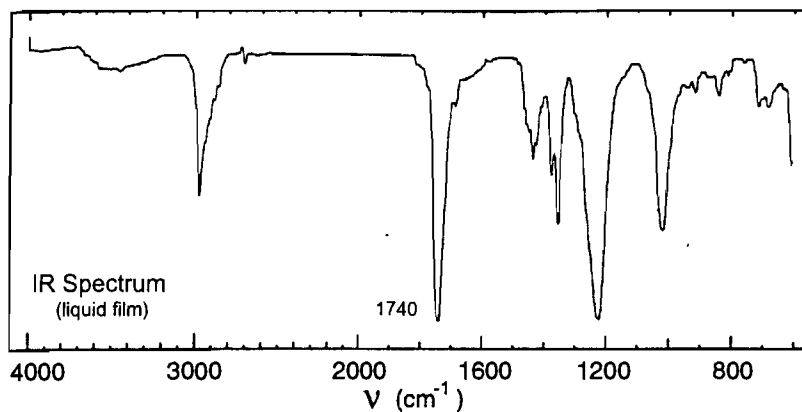

No significant UV  
absorption above 220 nm

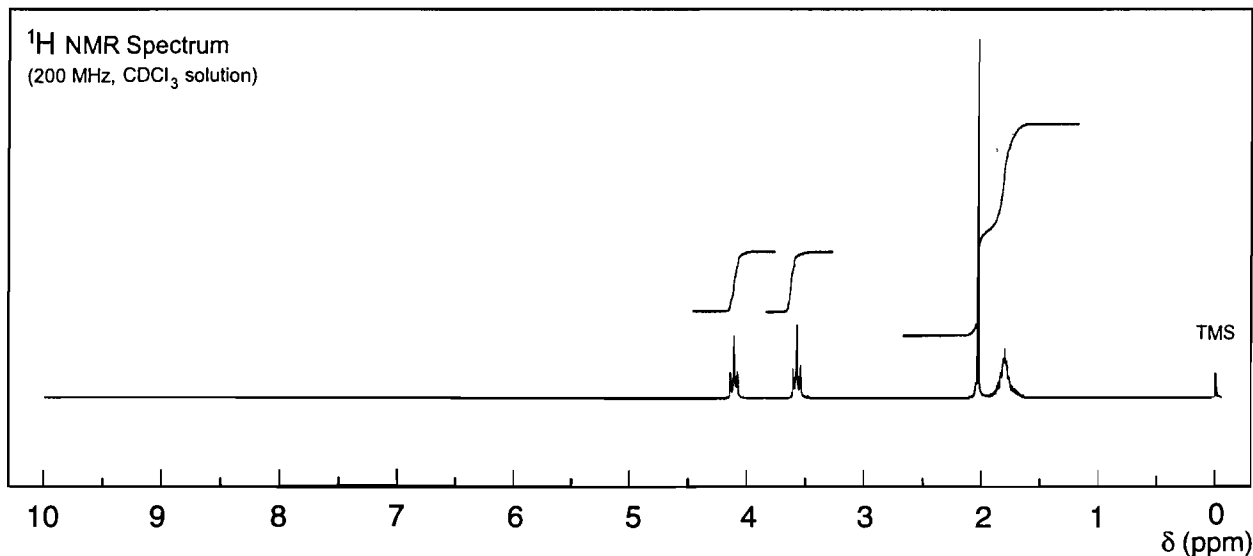
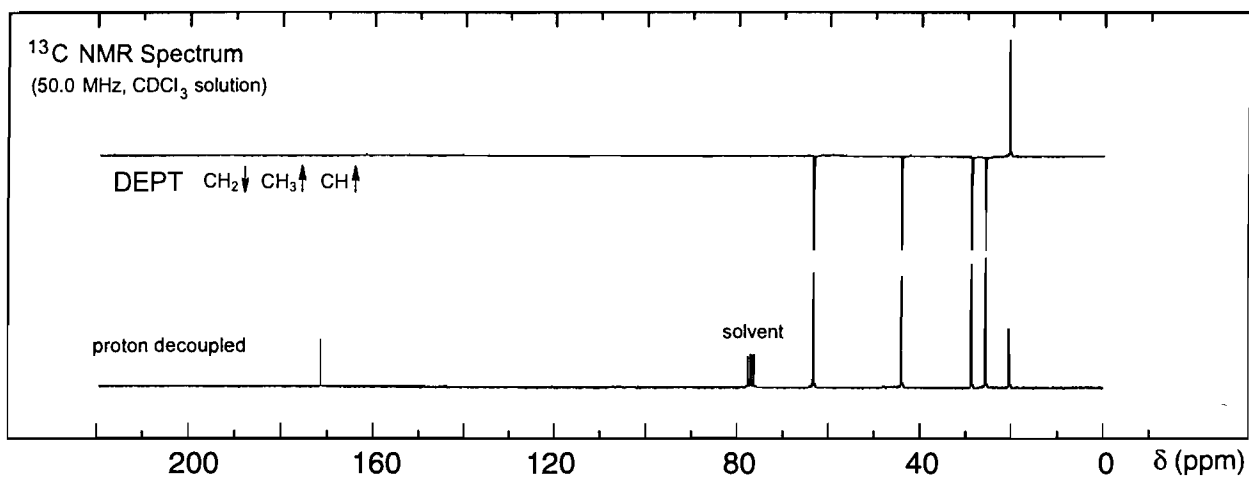

## Problem 85

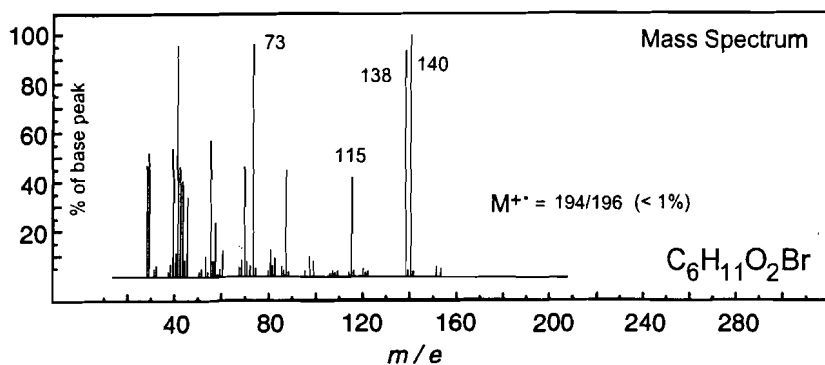
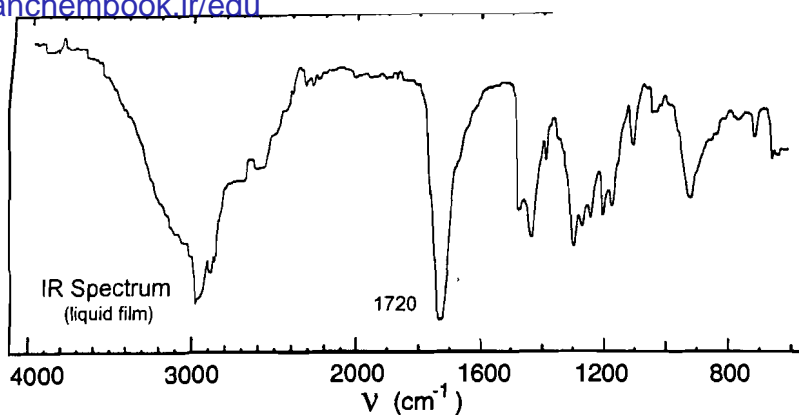

No significant UV  
absorption above 220 nm

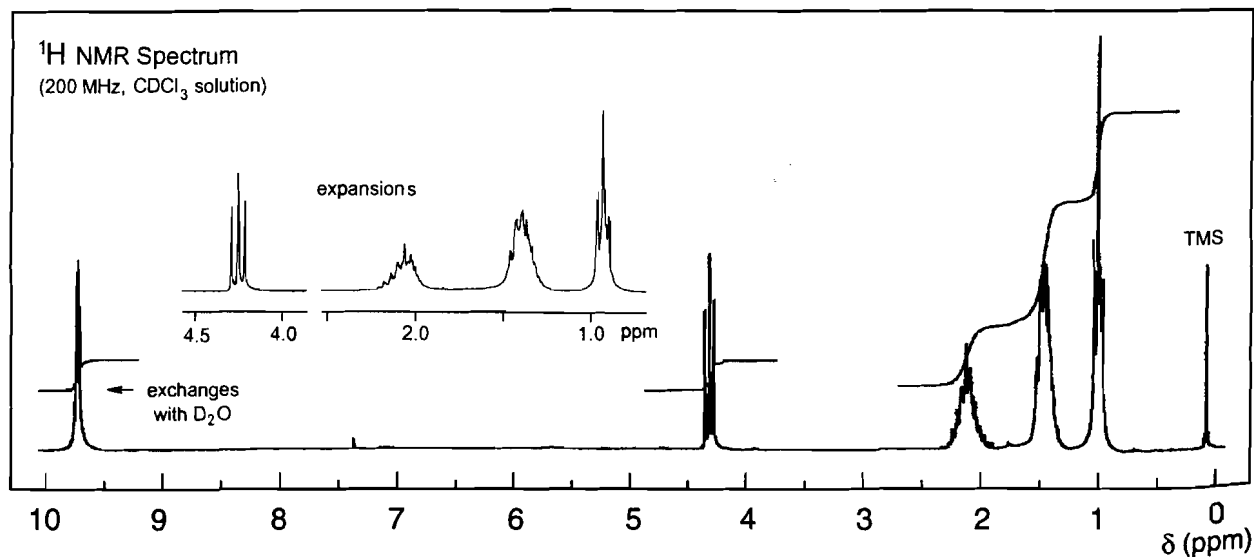
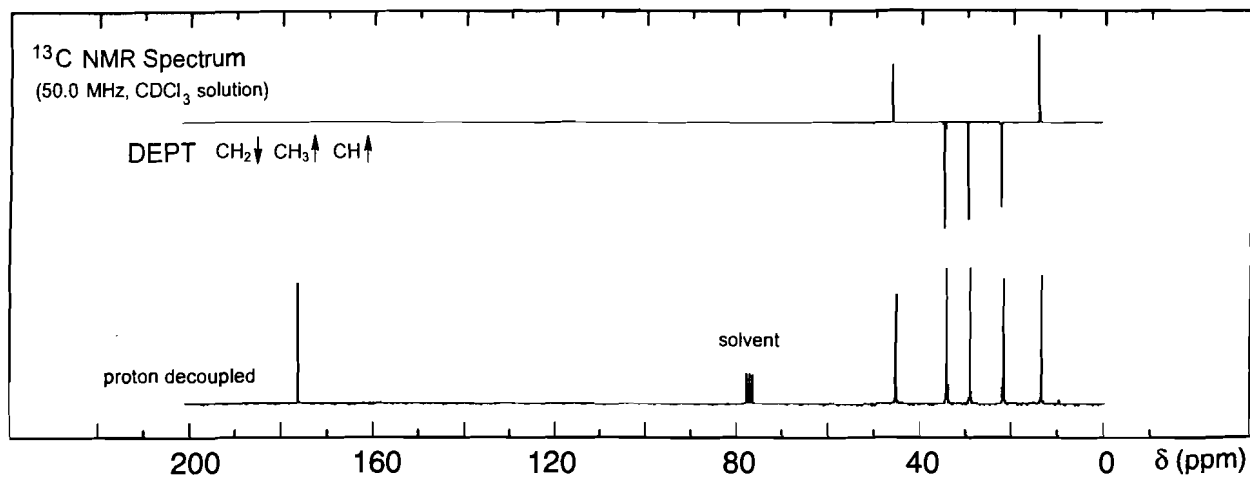

## Problem 86

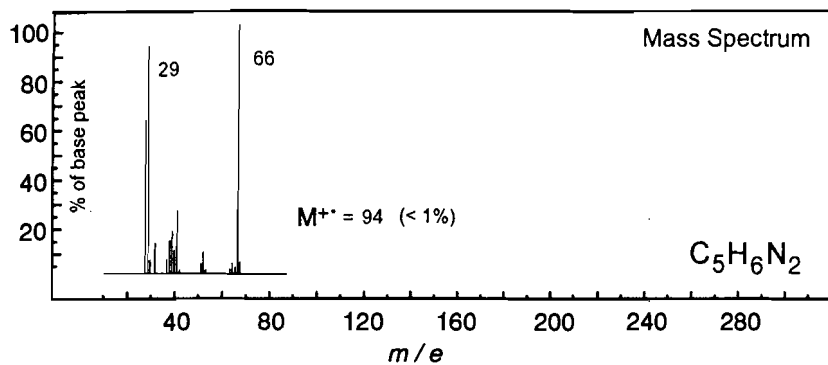
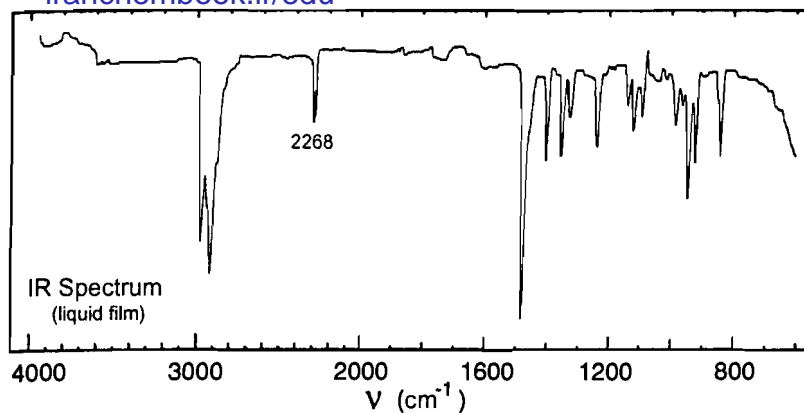

No significant UV  
absorption above 220 nm

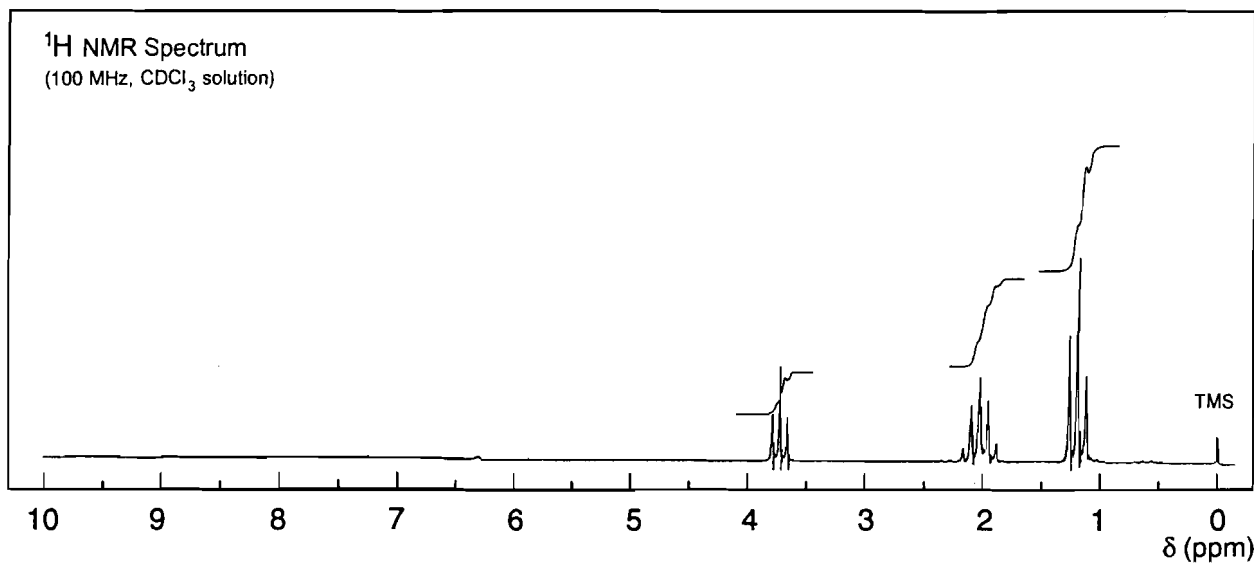
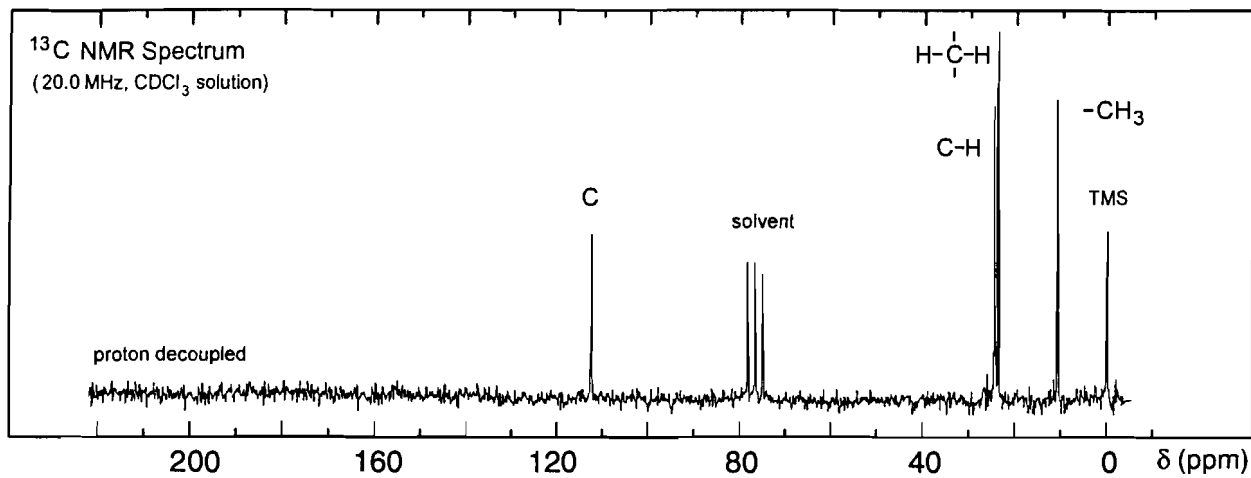



## Problem 87

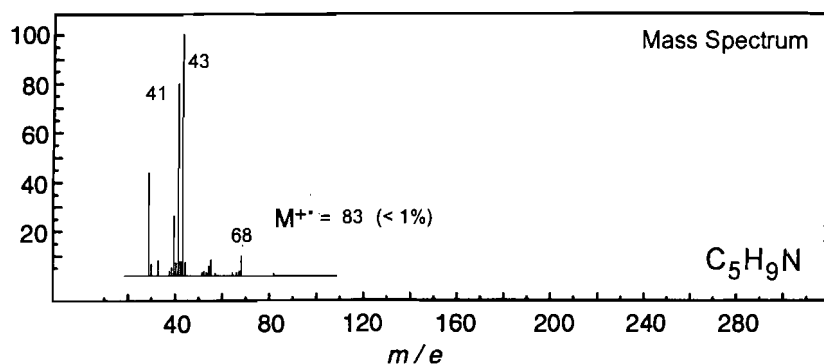
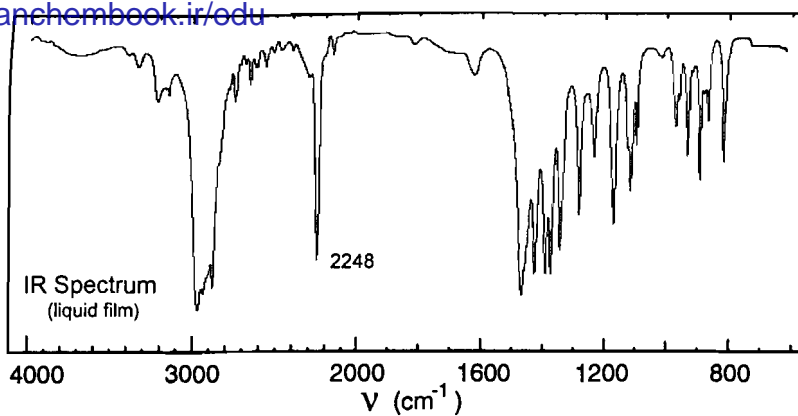

No significant UV  
absorption above 220 nm

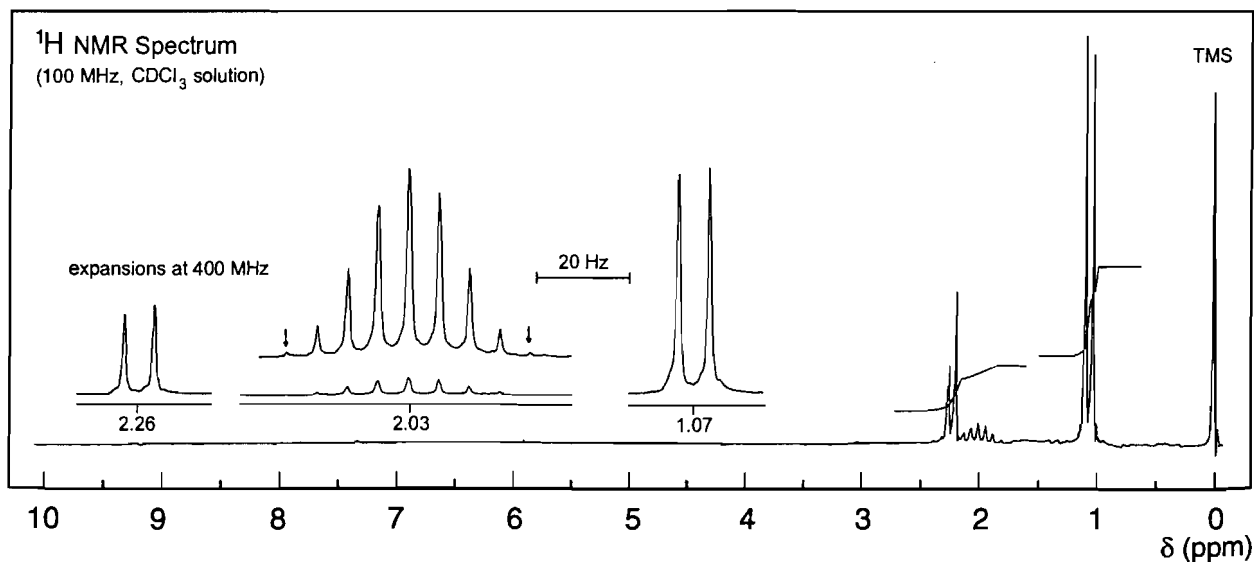
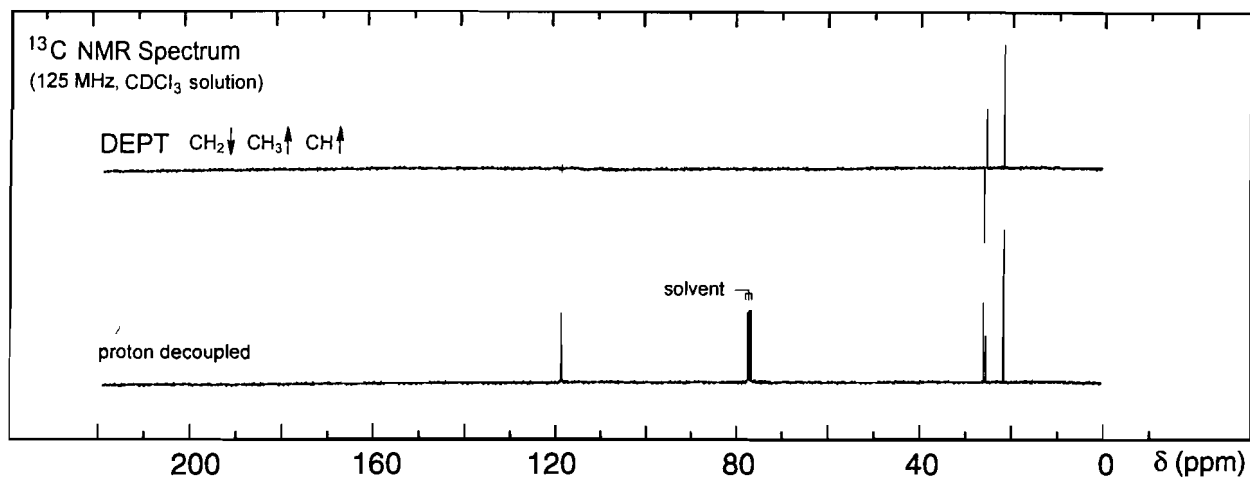

## Problem 88

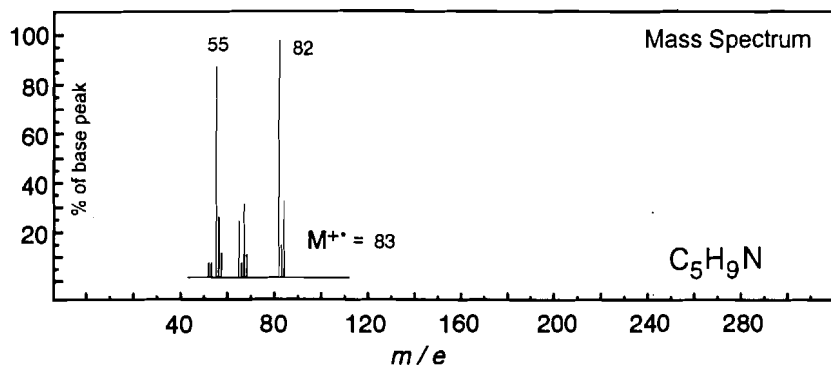
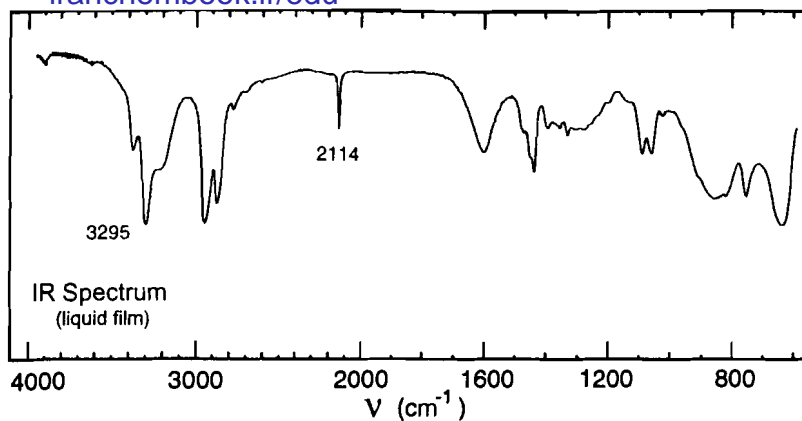

No significant UV  
absorption above 220 nm

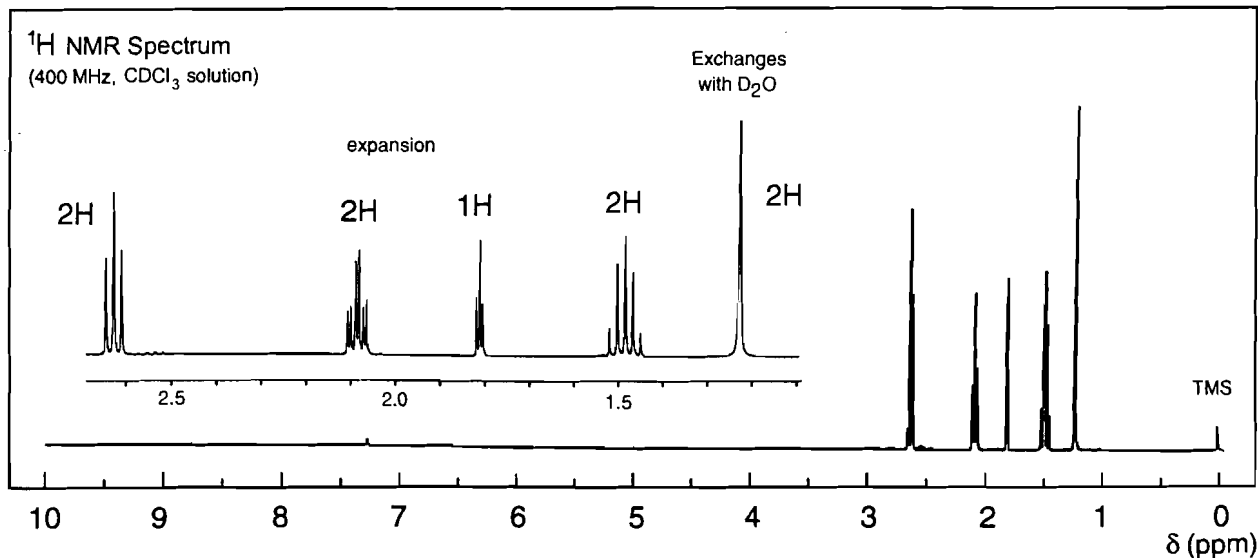
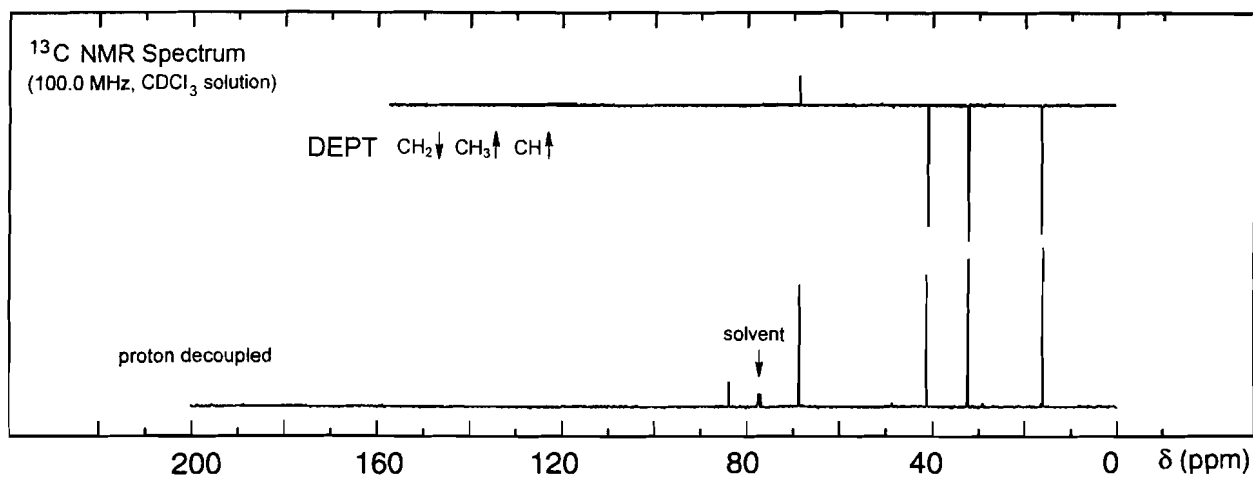

## Problem 89

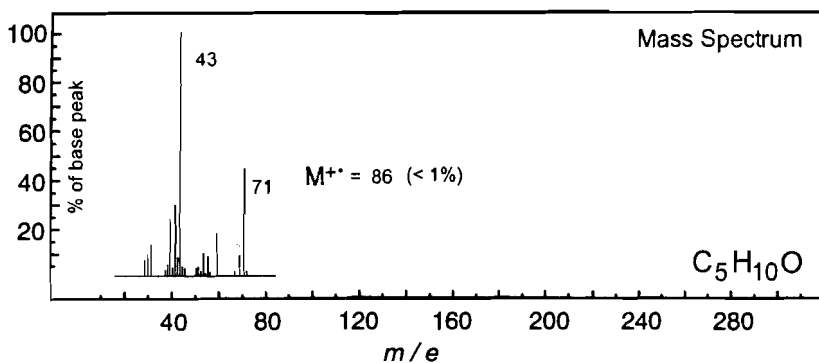
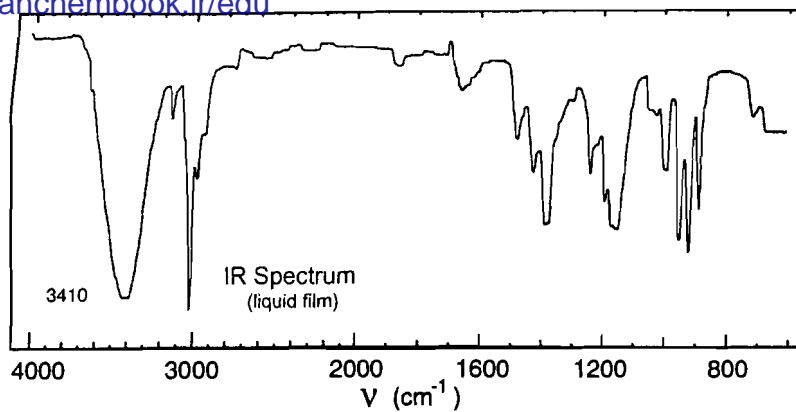

No significant UV  
absorption above 220 nm

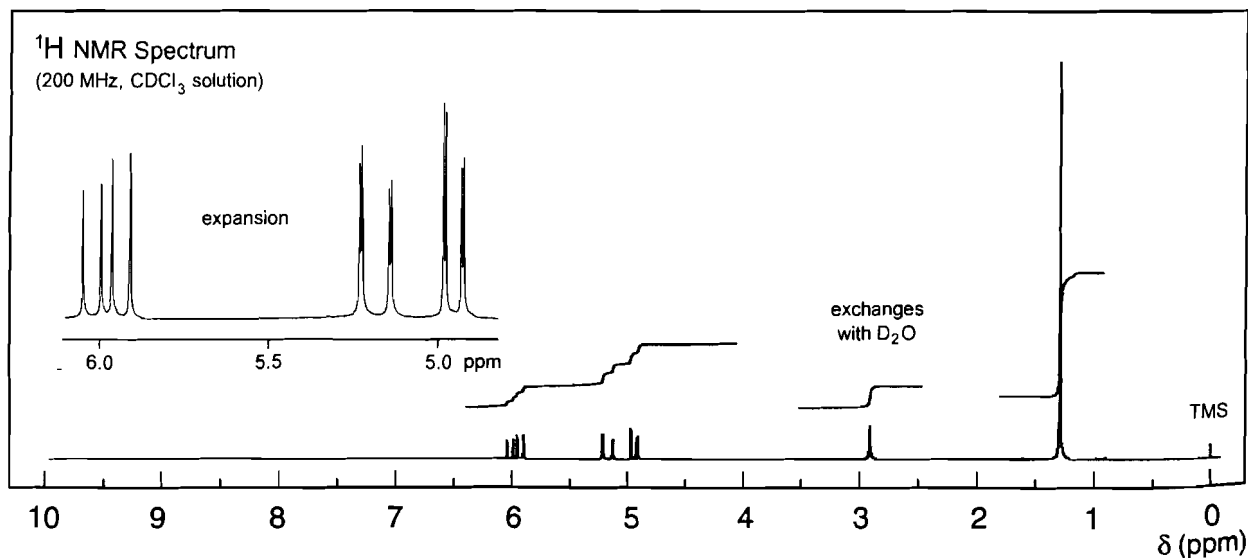
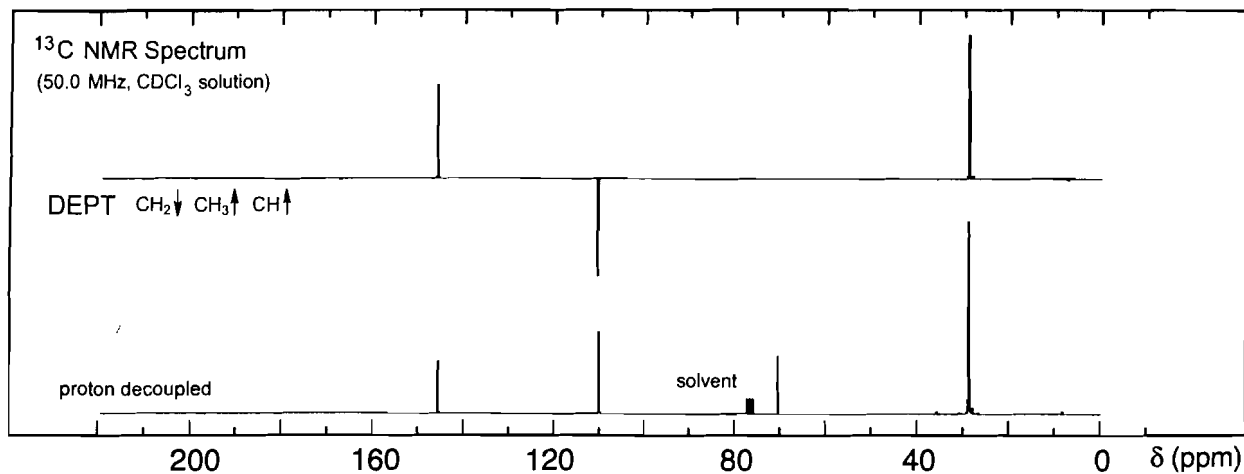

# Problem 90

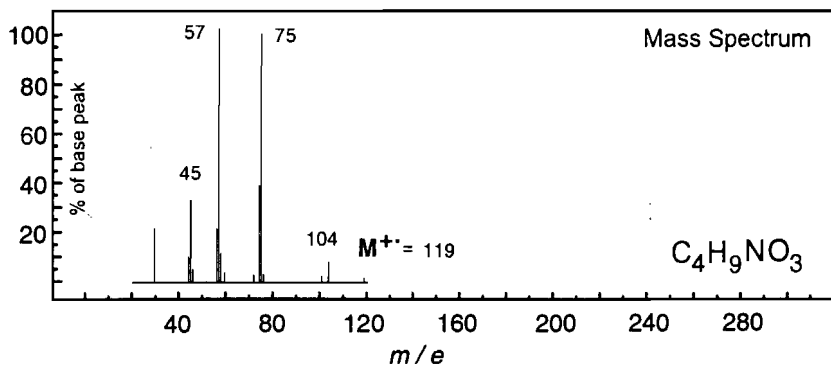
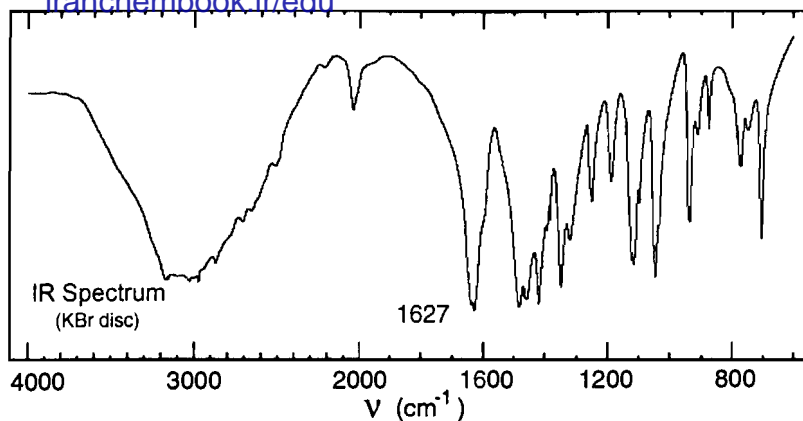

No significant UV absorption above 220 nm

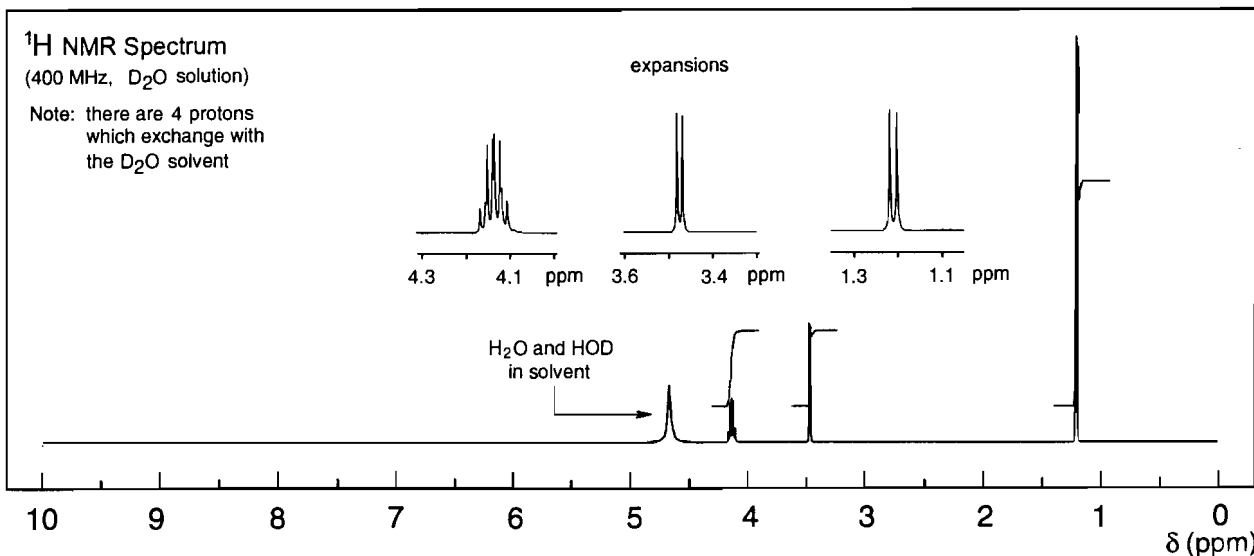
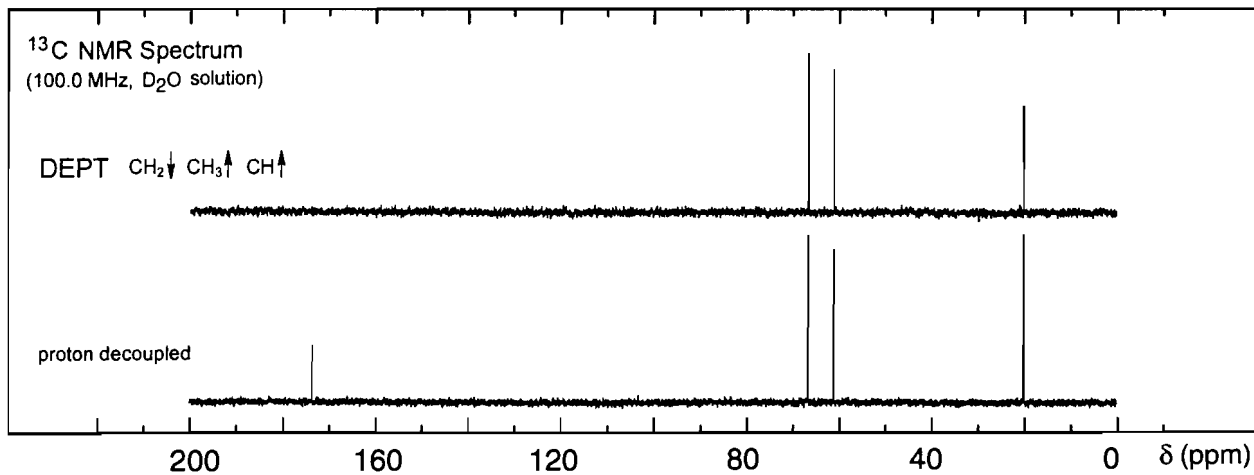

# Problem 91

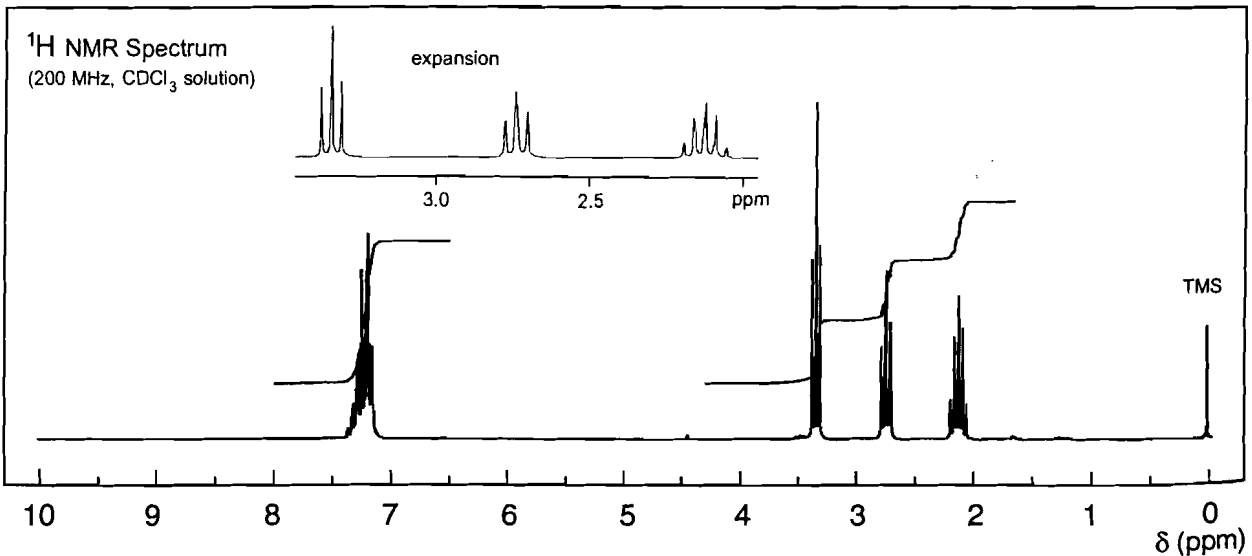
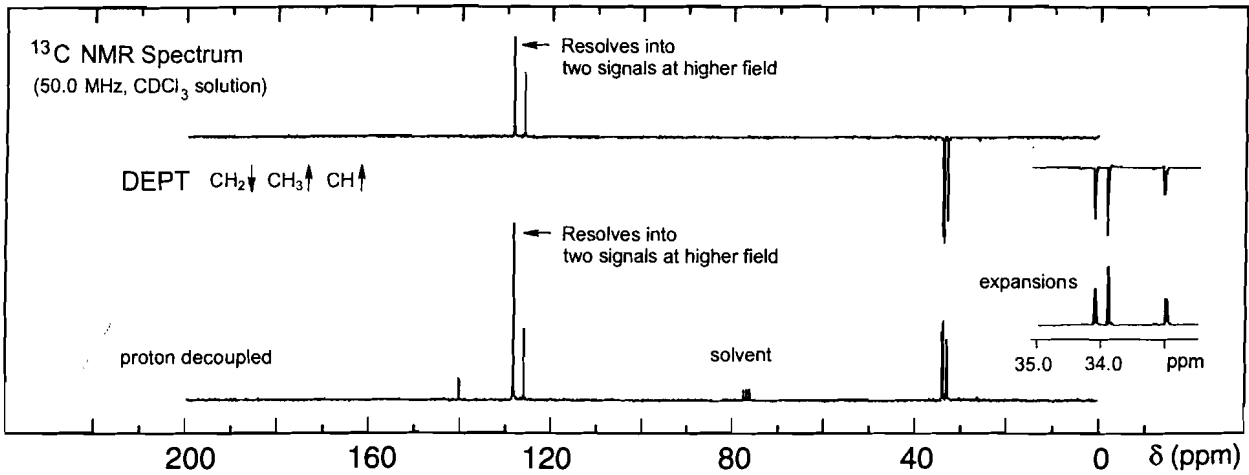
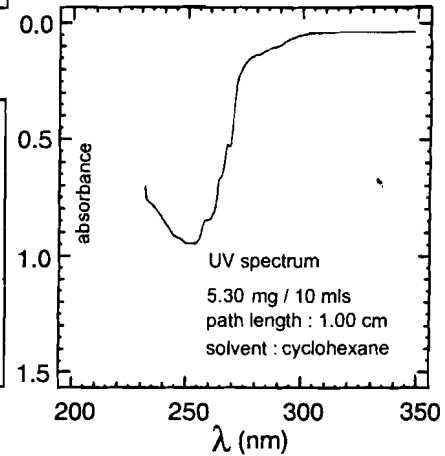
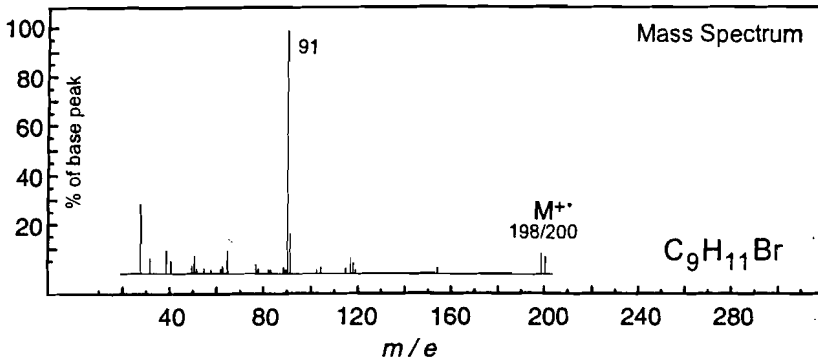
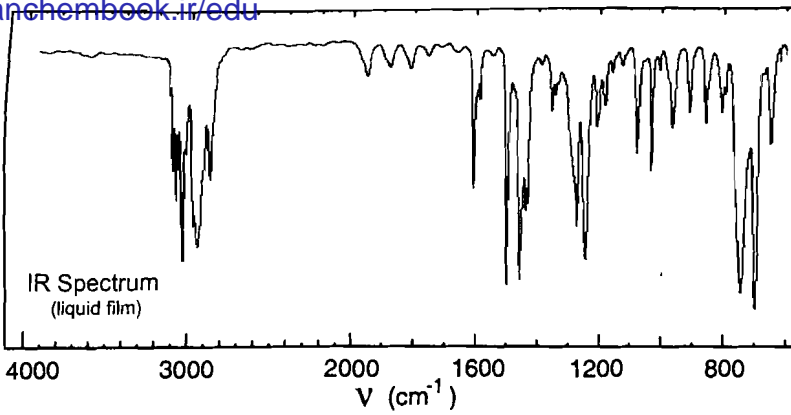

## Problem 92

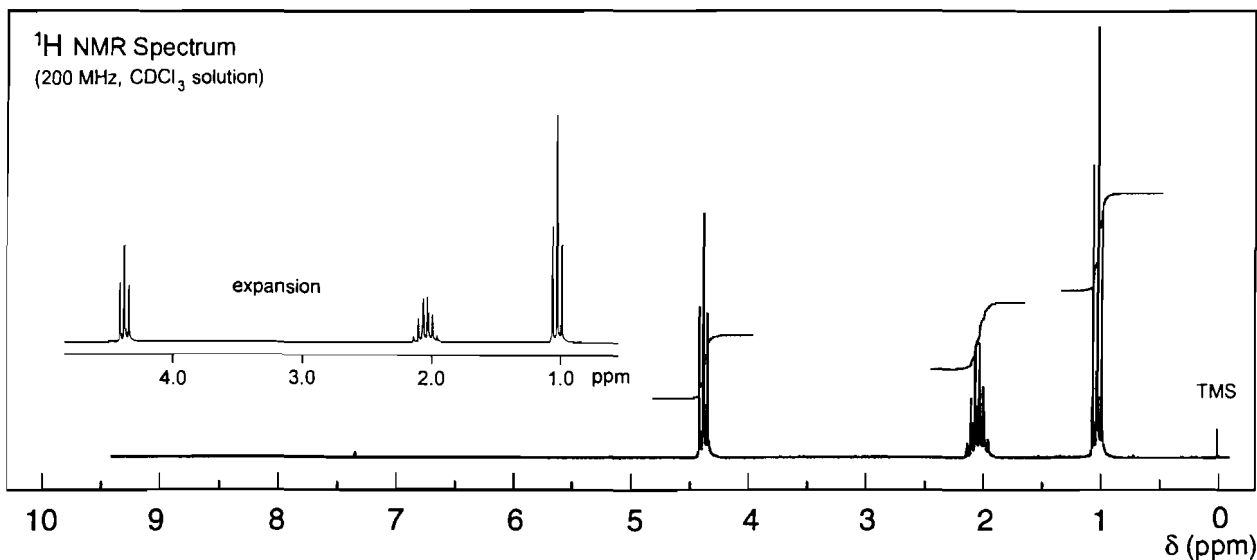
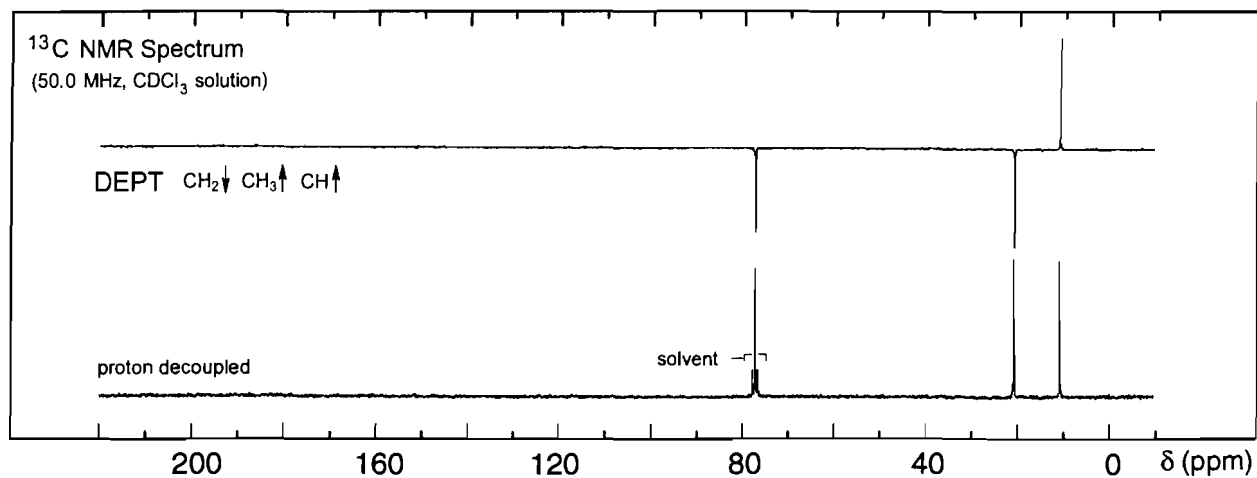
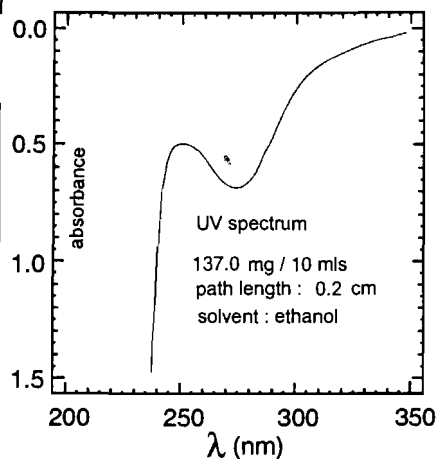
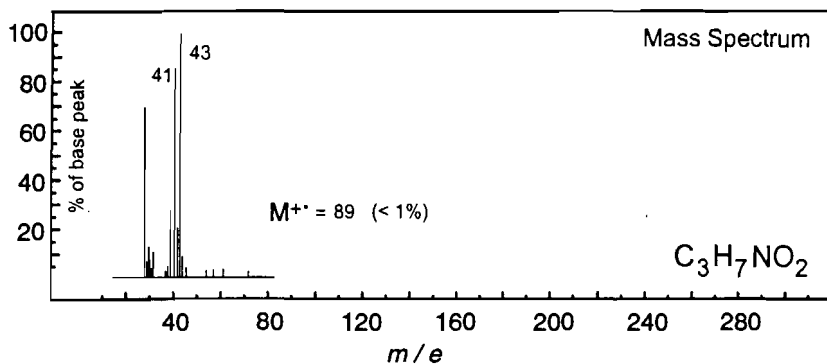
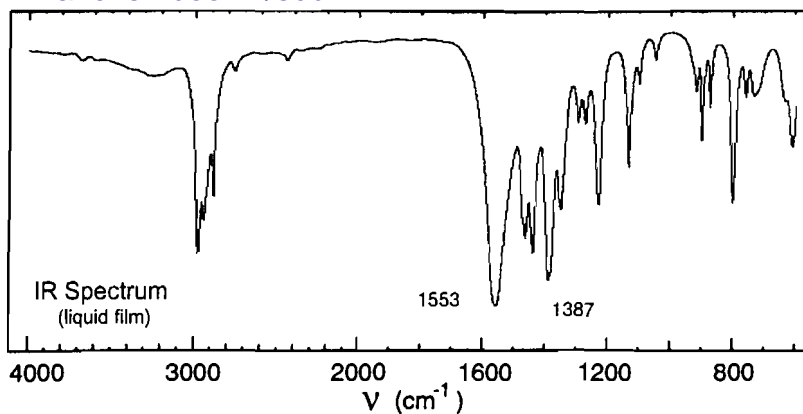

# Problem 93

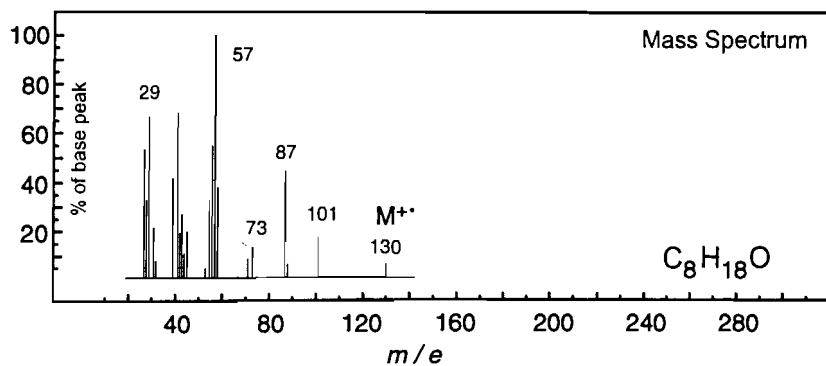
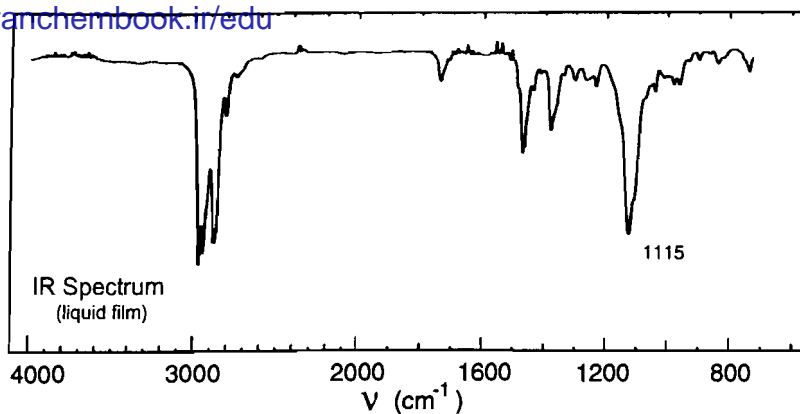

No significant UV  
absorption above 220 nm

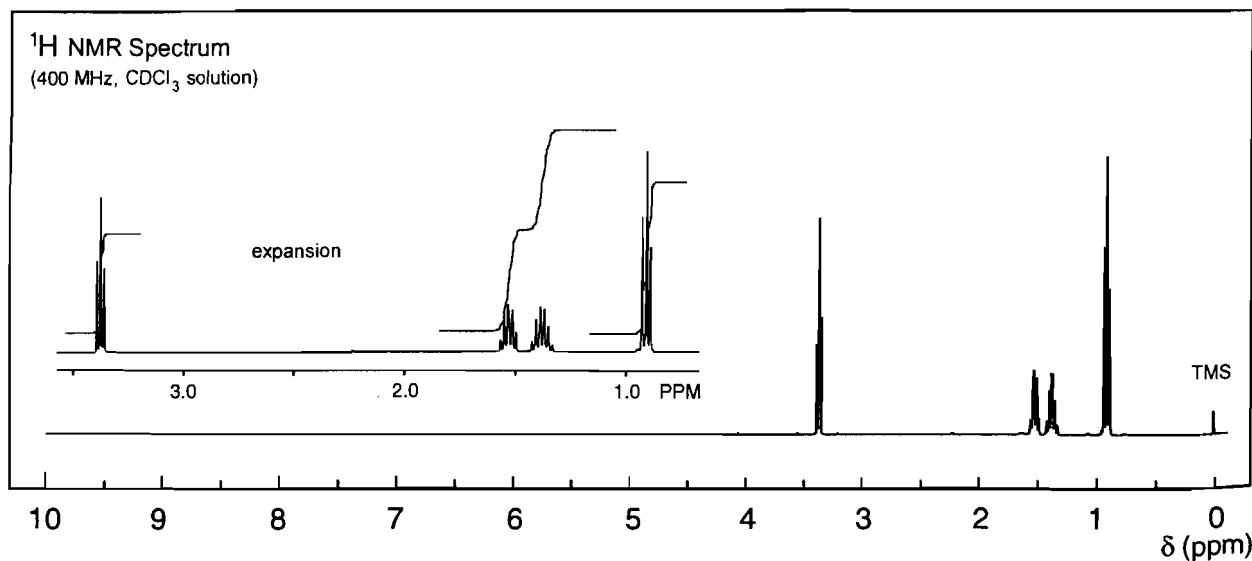
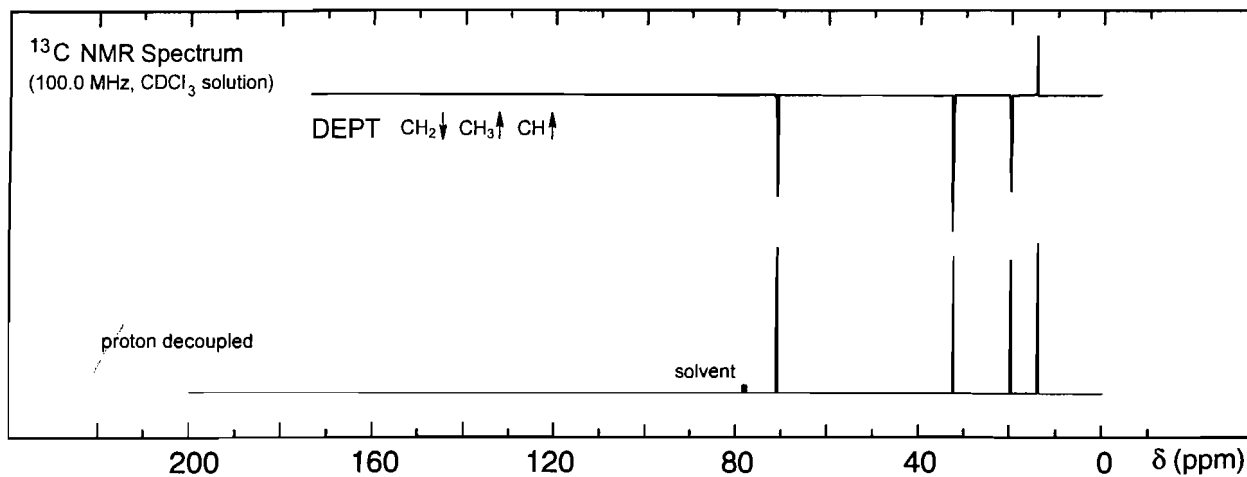

## Problem 94

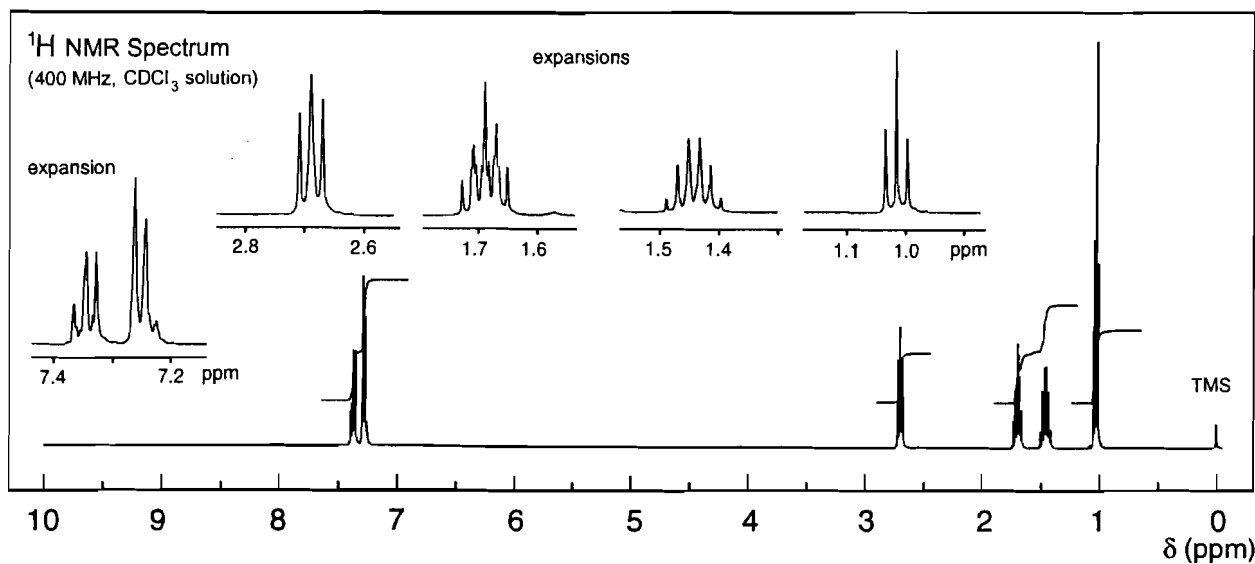
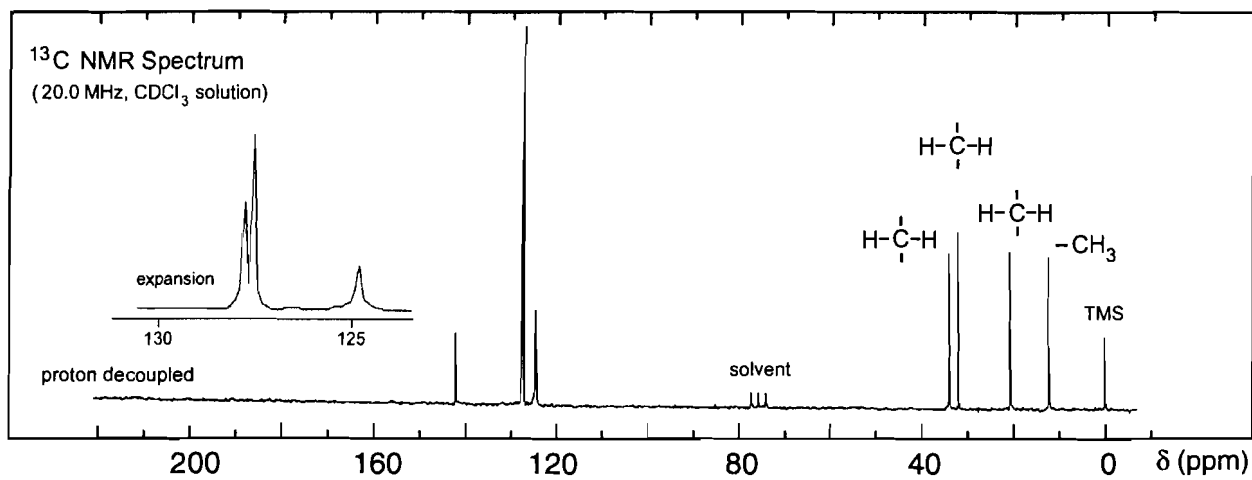
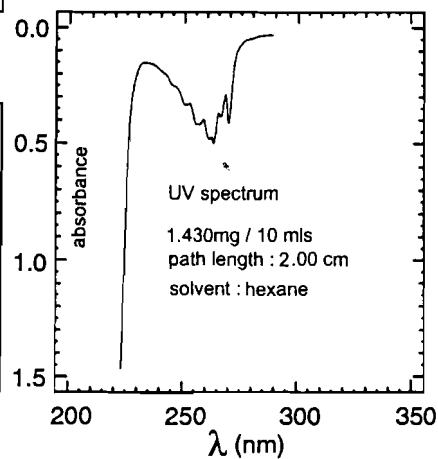
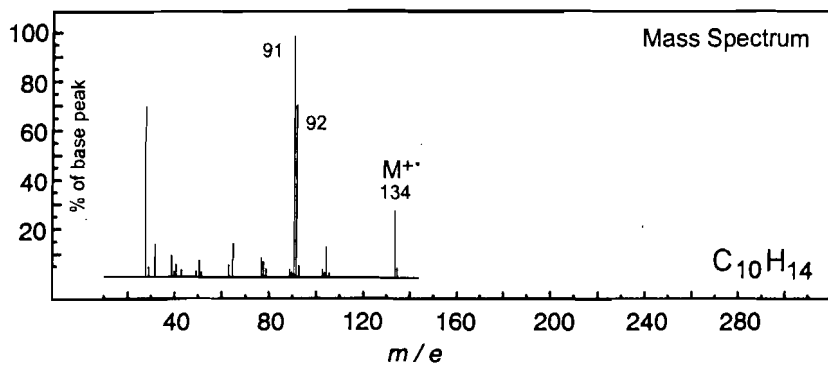
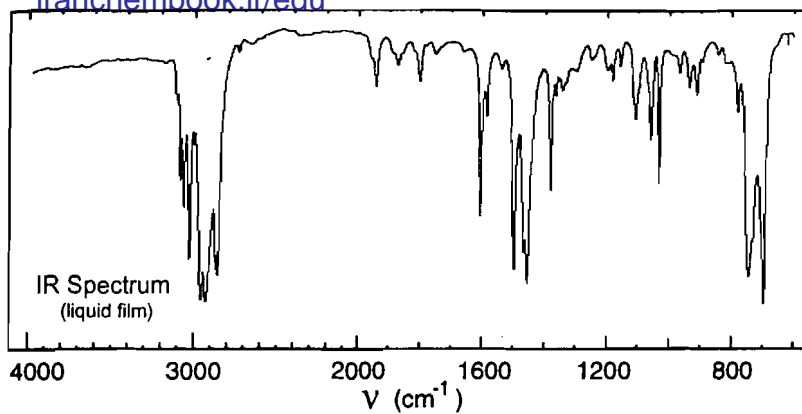



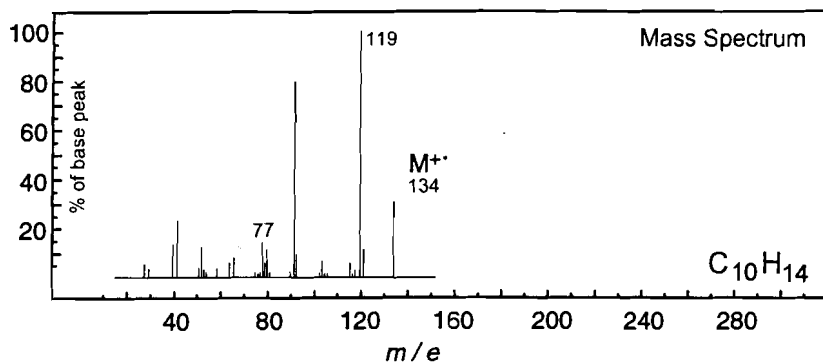
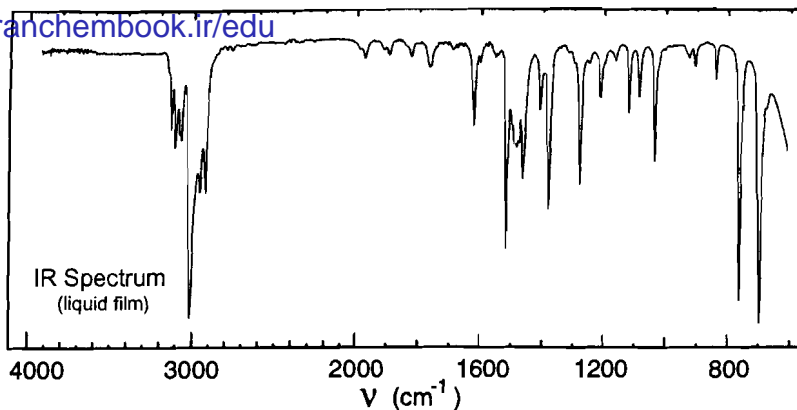

UV Spectrum

$$\lambda_{\max} 262 \text{ nm } (\log_{10} \epsilon 2.5)$$

solvent: ethanol

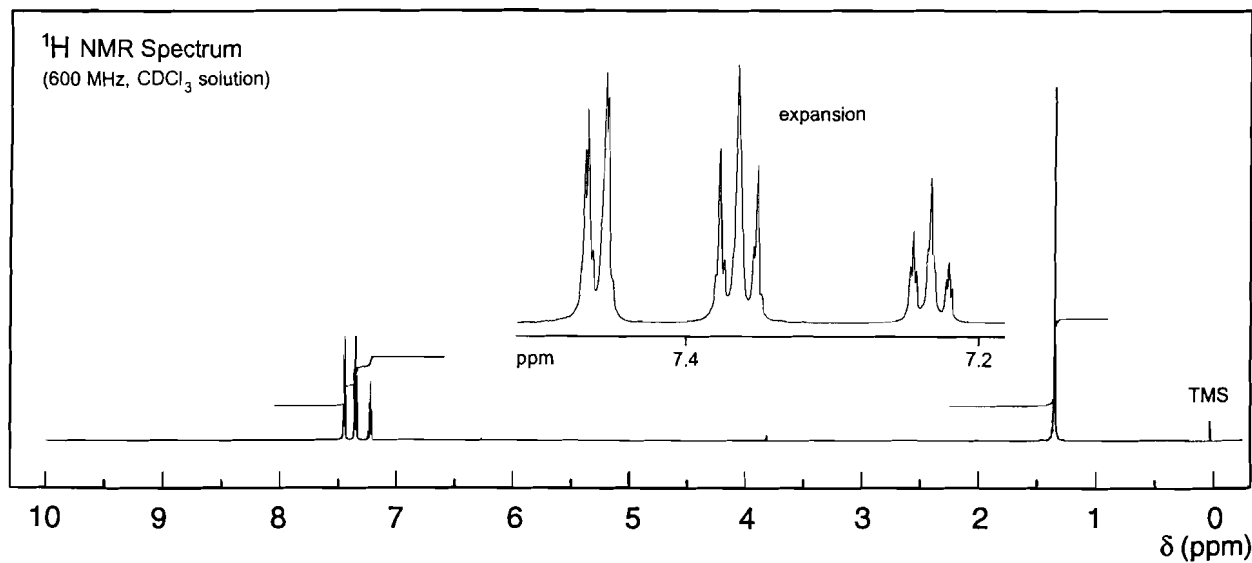
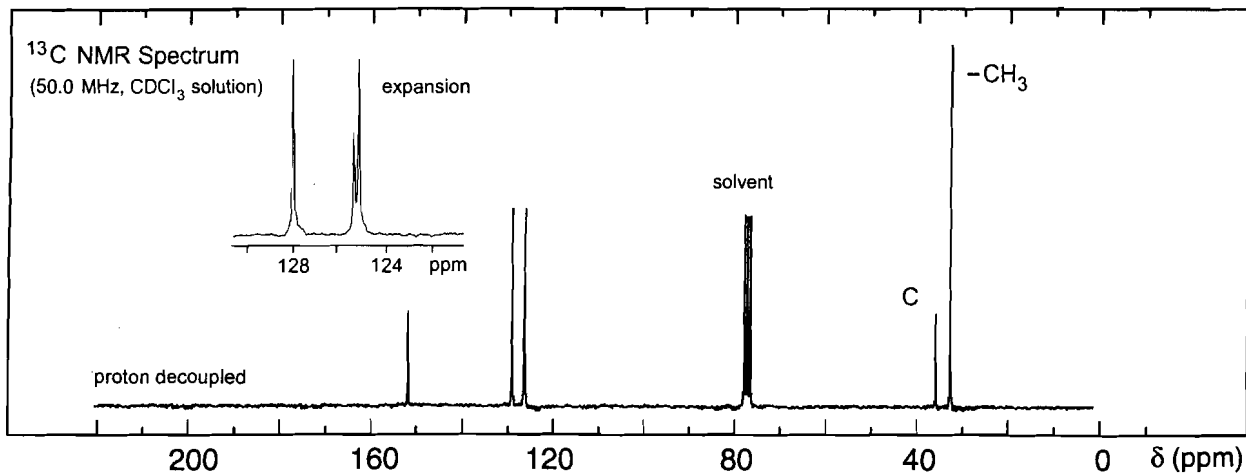

## Problem 96

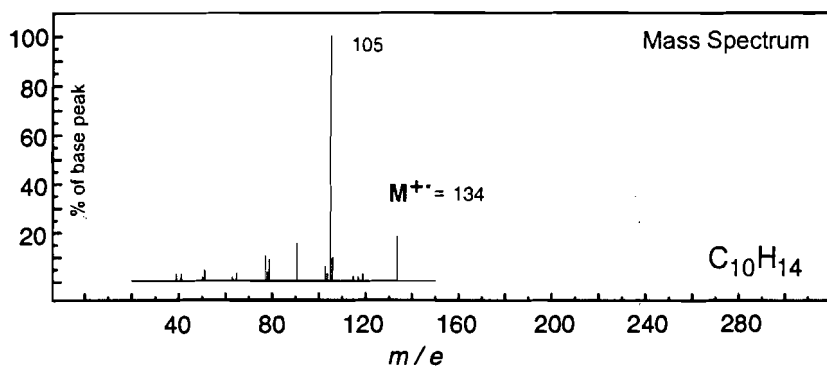
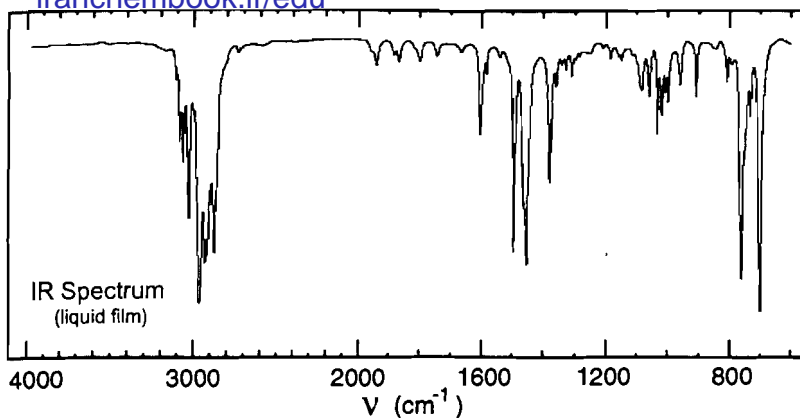

UV Spectrum

$$\lambda_{\text{max}} \approx 260 \text{ nm} \quad (\log_{10} \epsilon \approx 2.5)$$

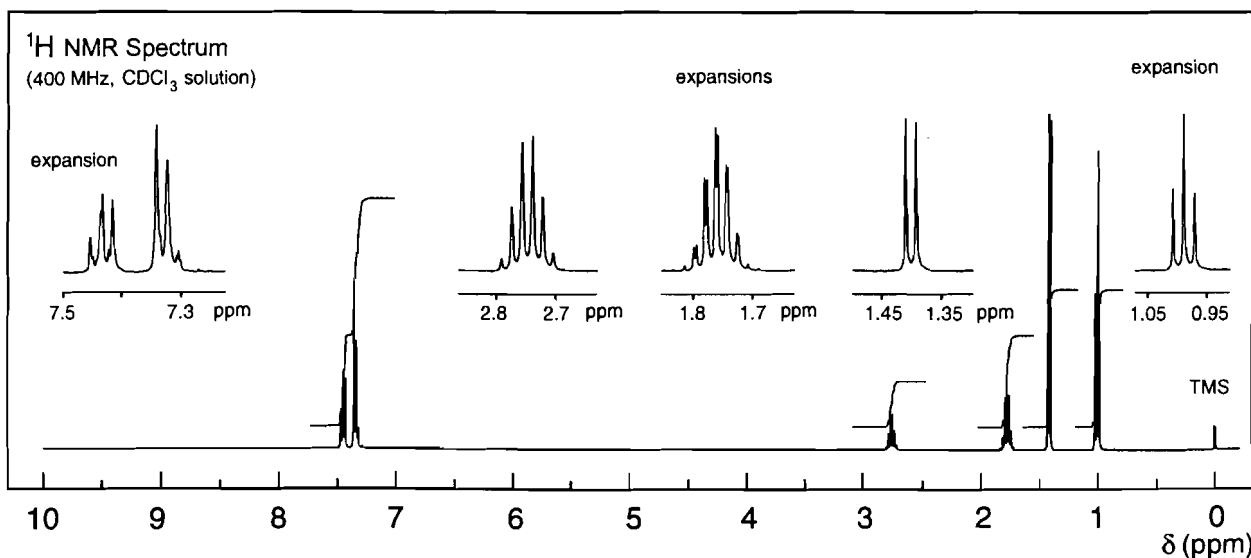
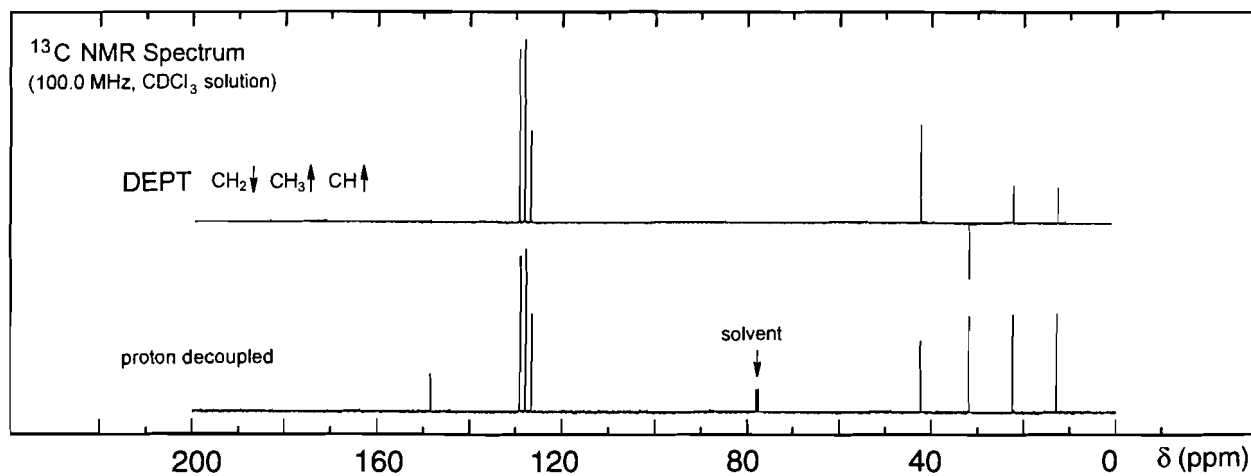

## Problem 97

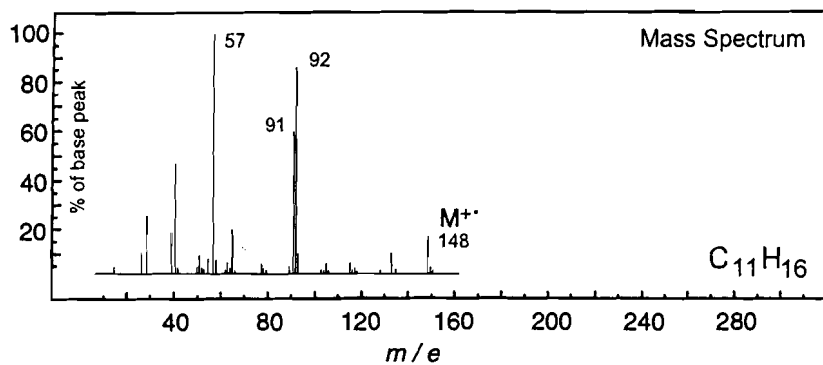
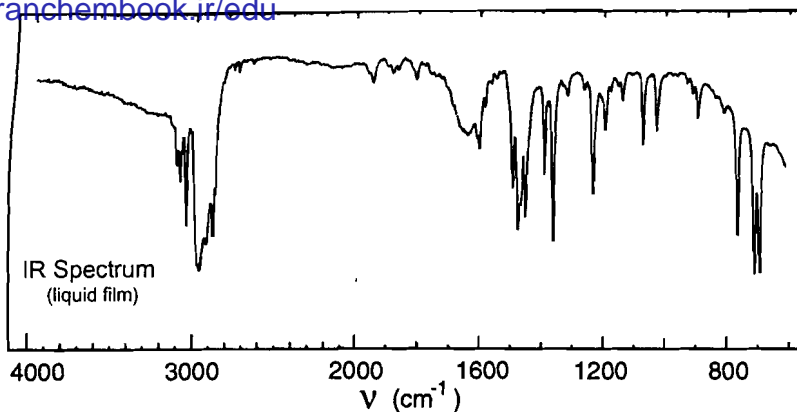

UV Spectrum

 $\lambda_{\max}$  260 nm ( $\log_{10} \epsilon$  2.5)

solvent : methanol

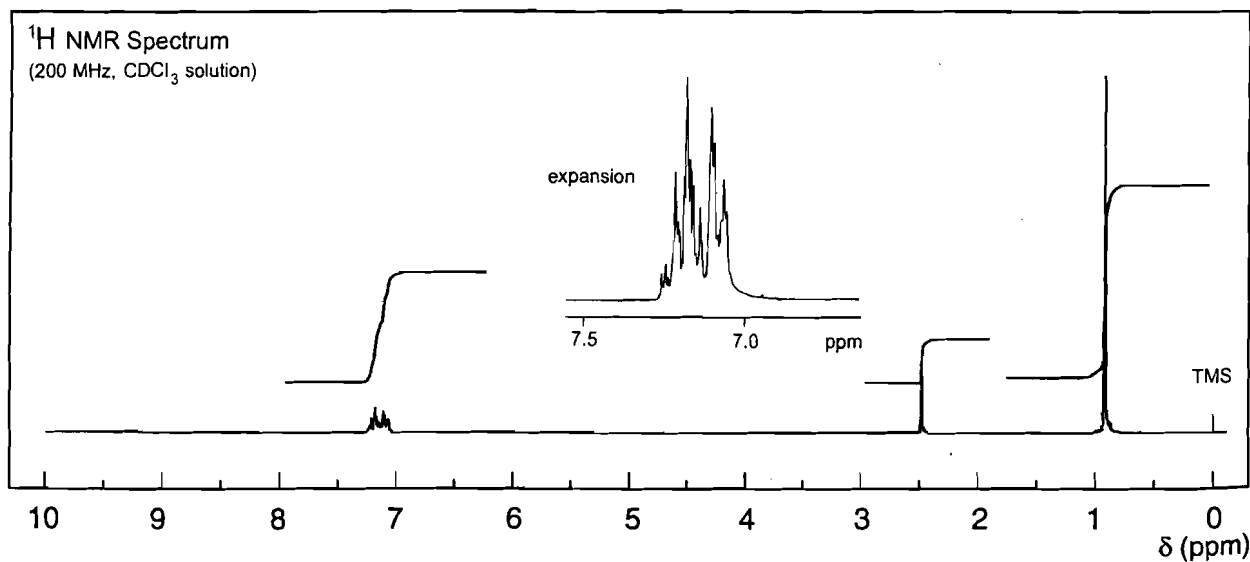
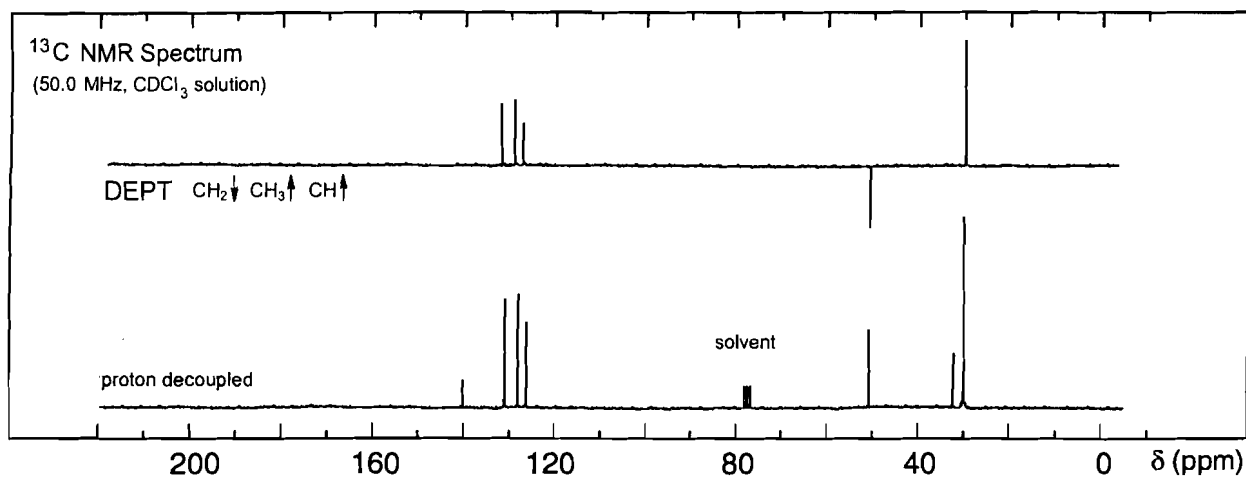

## Problem 98

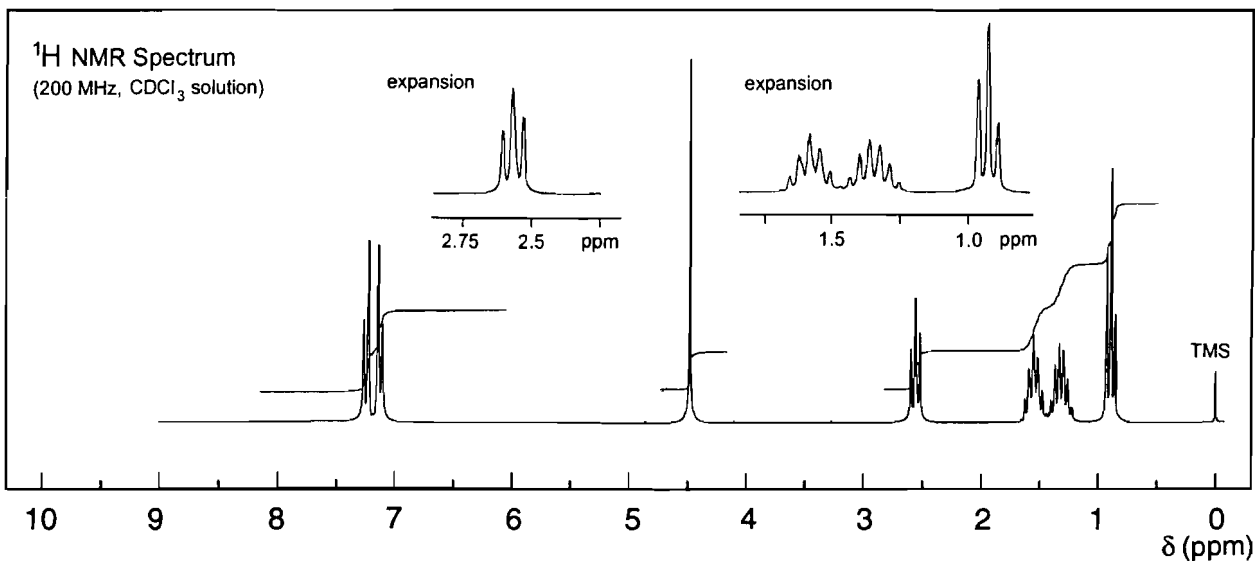
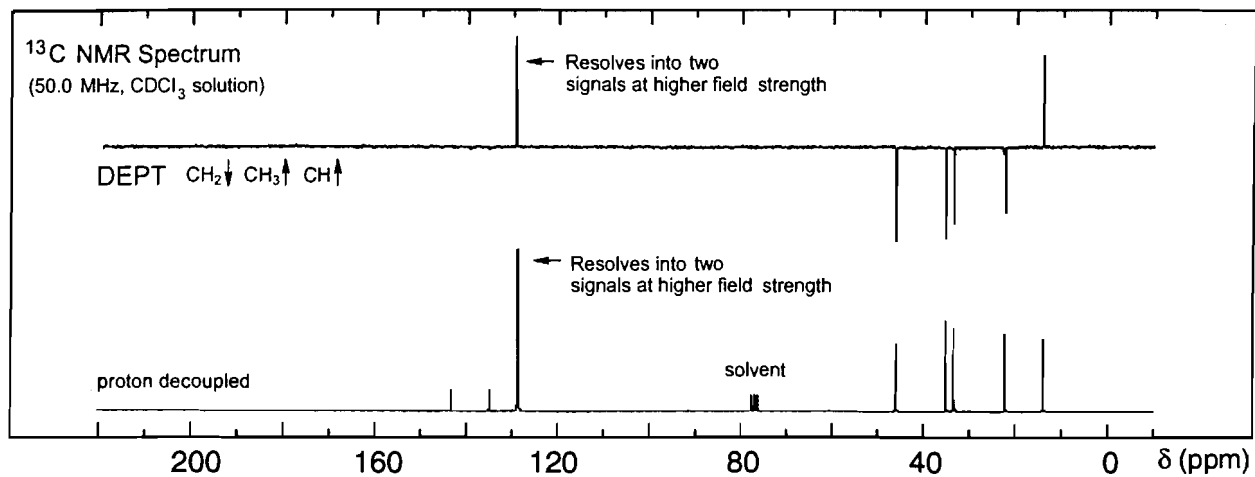
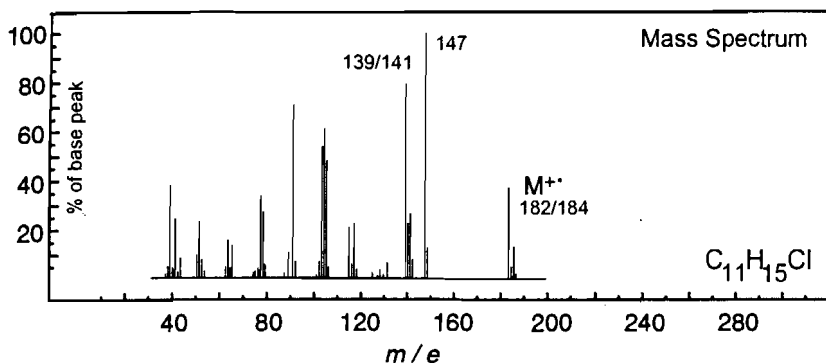
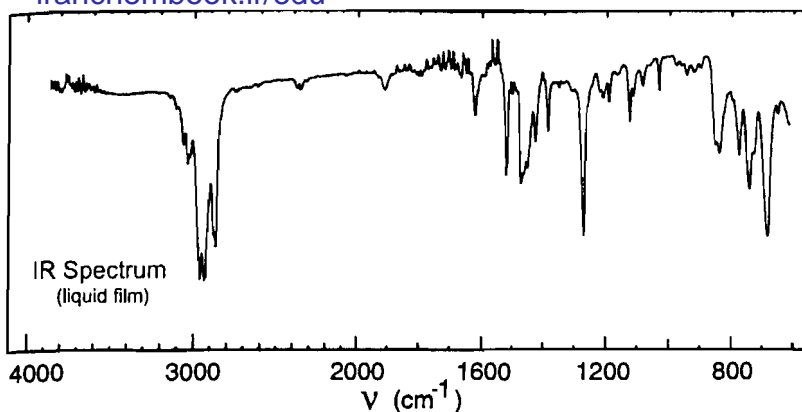

## Problem 99

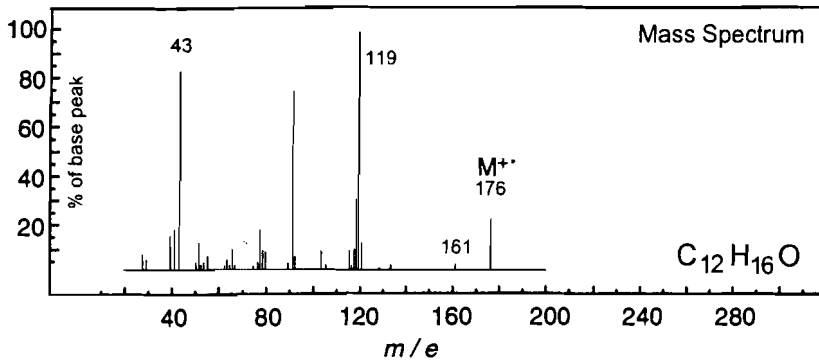
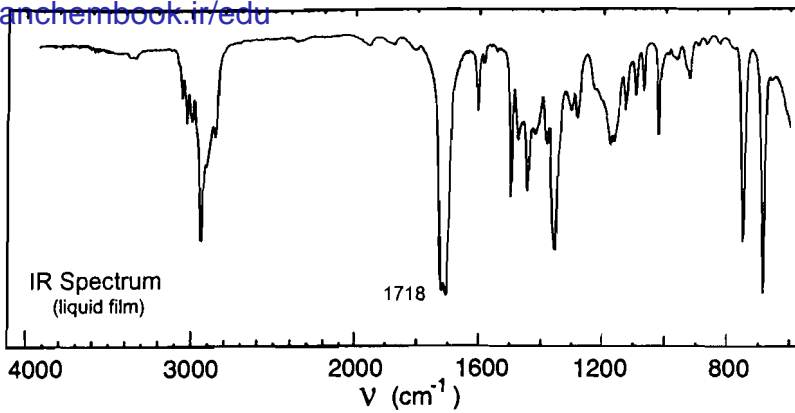

UV Spectrum

$$\lambda_{\max} 262 \text{ nm } (\log_{10} \epsilon 2.5)$$

solvent : methanol

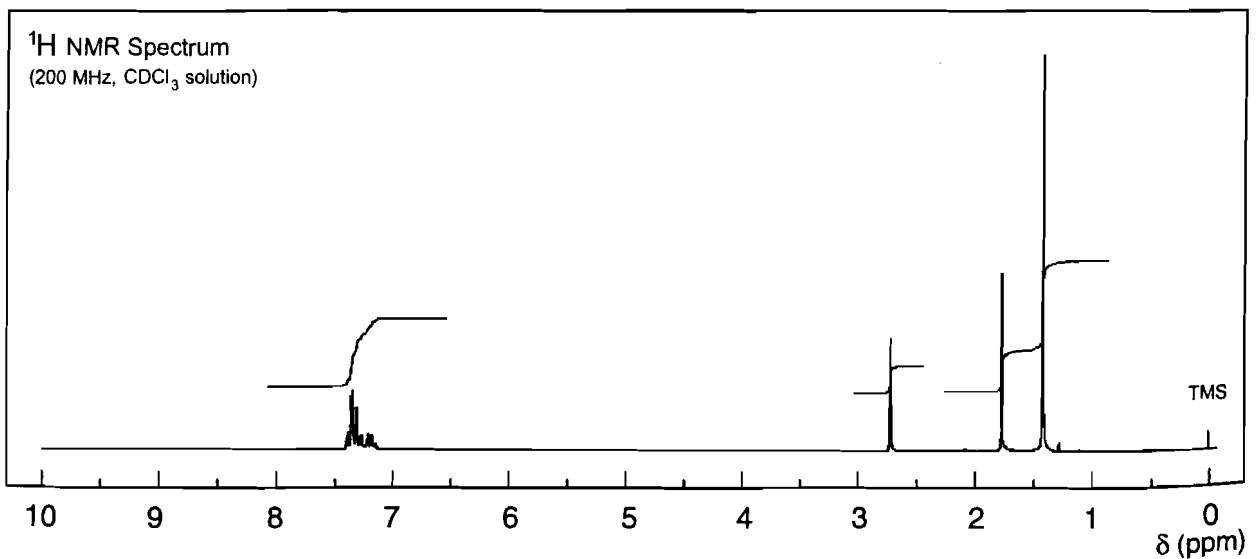
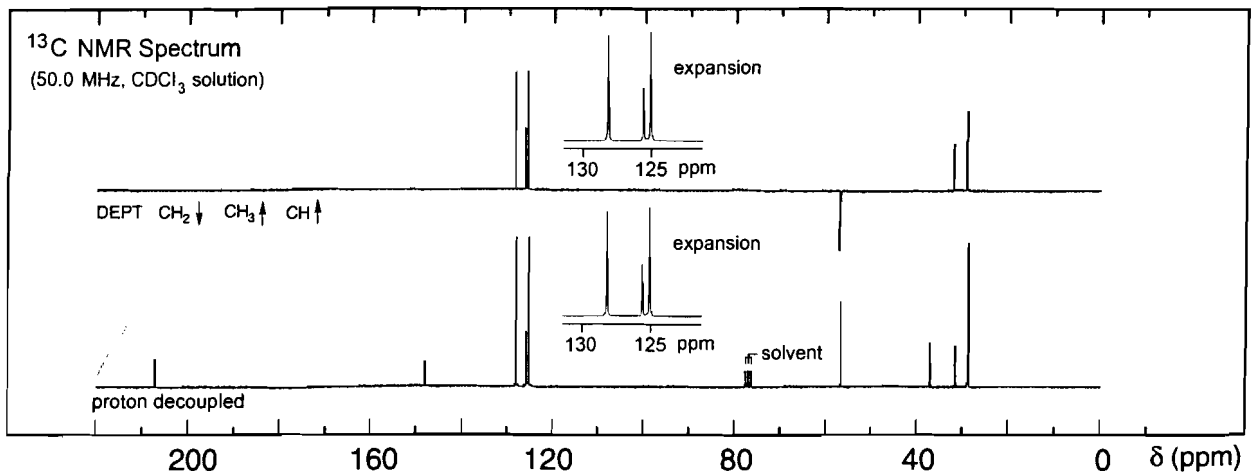

## Problem 100

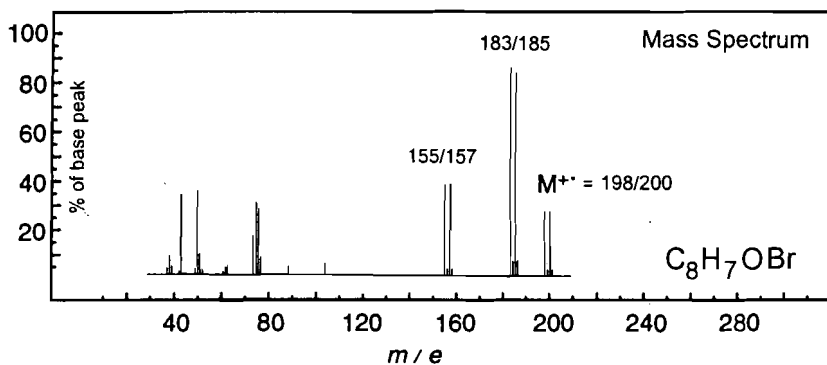
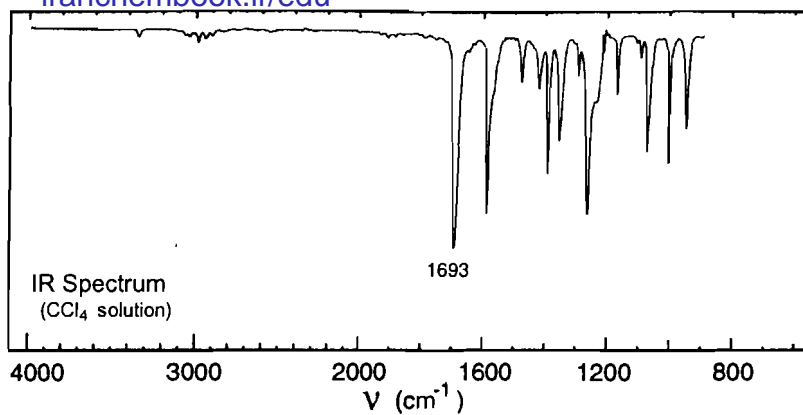

UV Spectrum

 $\lambda_{\max}$  258 nm (log<sub>10</sub>  $\epsilon$  4.2)

solvent: ethanol

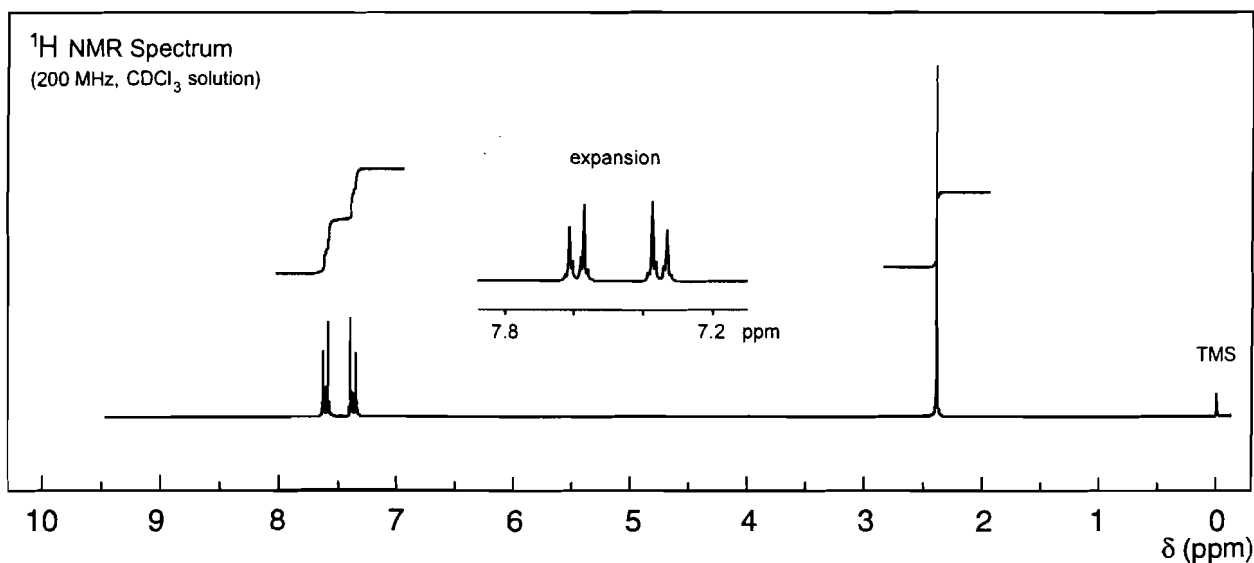
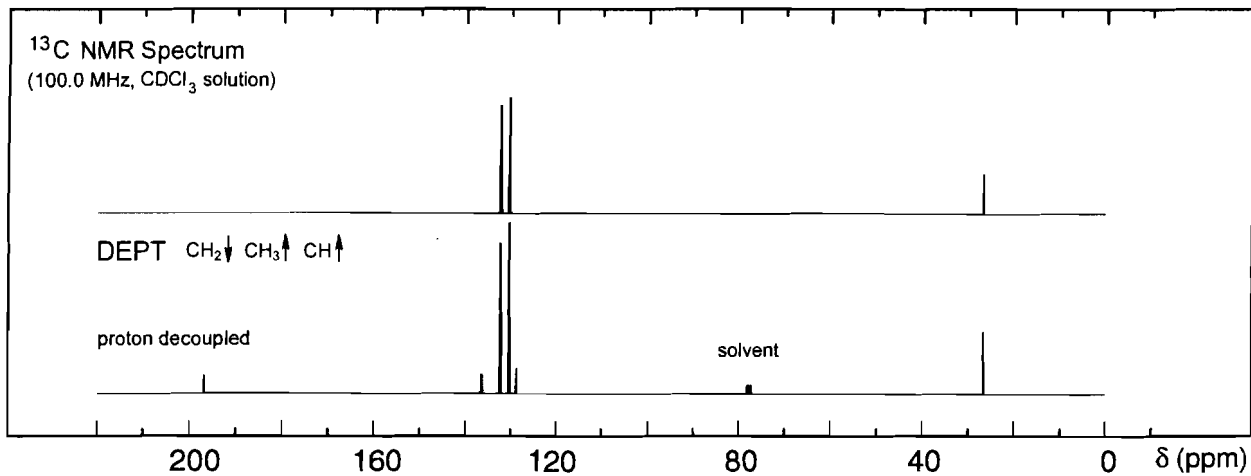

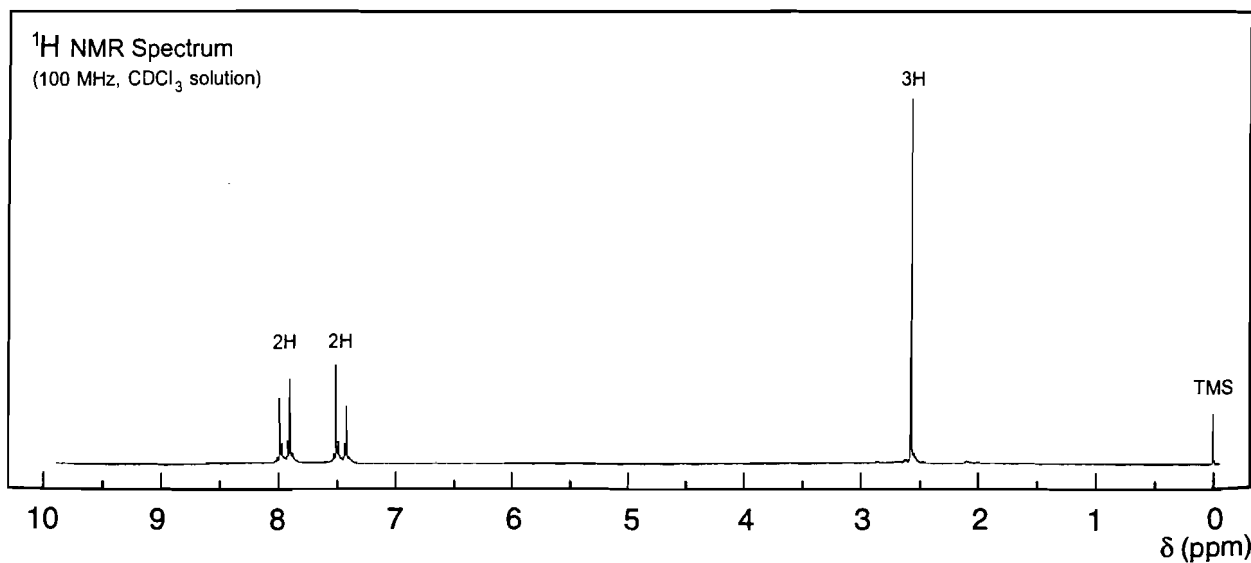
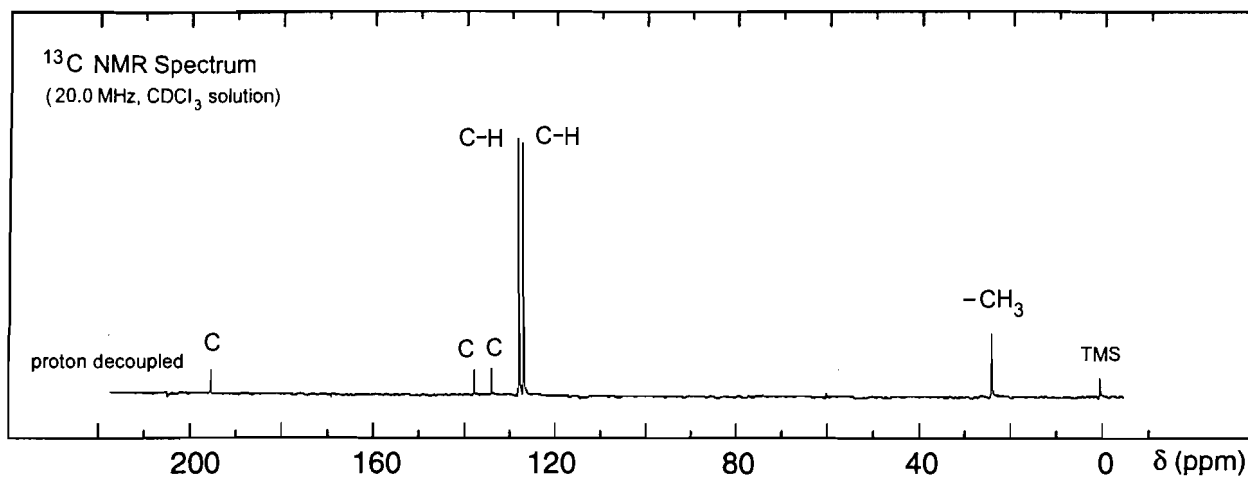
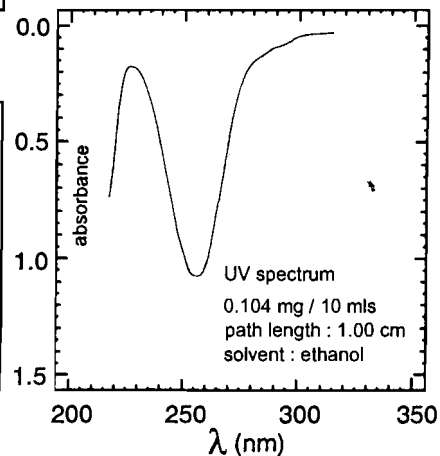
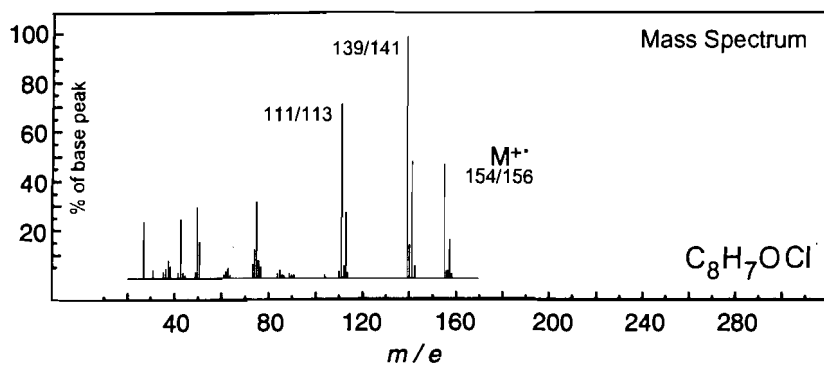
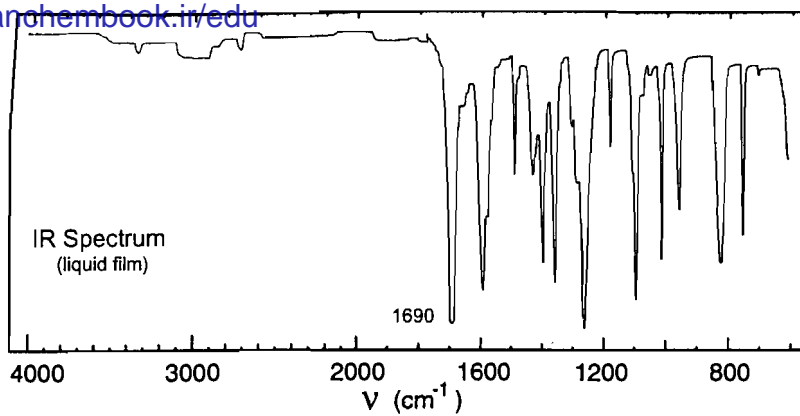

## Problem 102

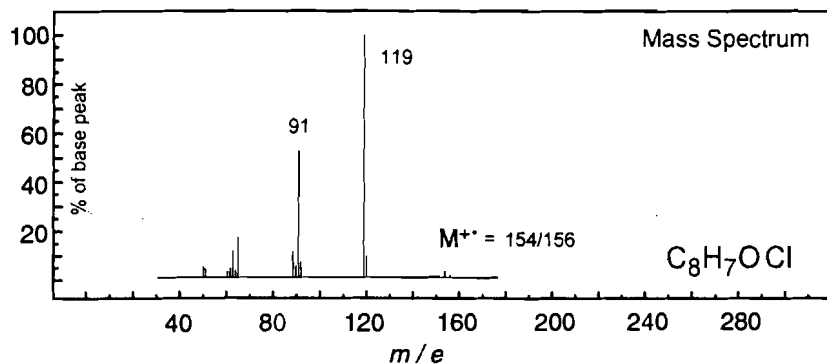
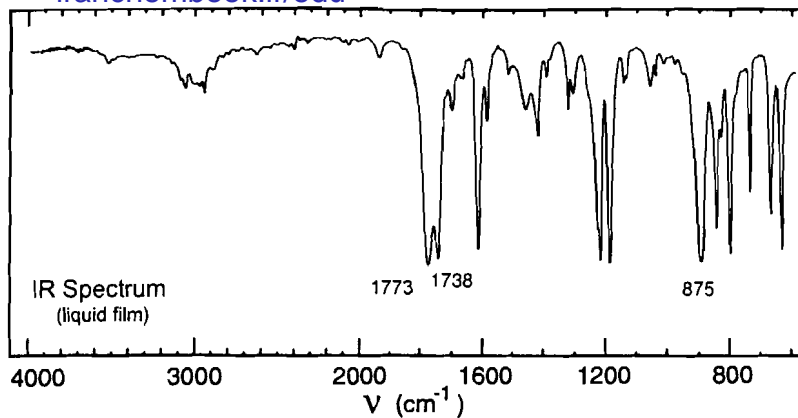

UV Spectrum

 $\lambda_{\text{max}}$  254 nm ( $\log_{10} \epsilon$  4.3) $\lambda_{\text{max}}$  258 nm ( $\log_{10} \epsilon$  4.2) $\lambda_{\text{max}}$  279 nm ( $\log_{10} \epsilon$  3.3) $\lambda_{\text{max}}$  290 nm ( $\log_{10} \epsilon$  3.0)

solvent: hexane

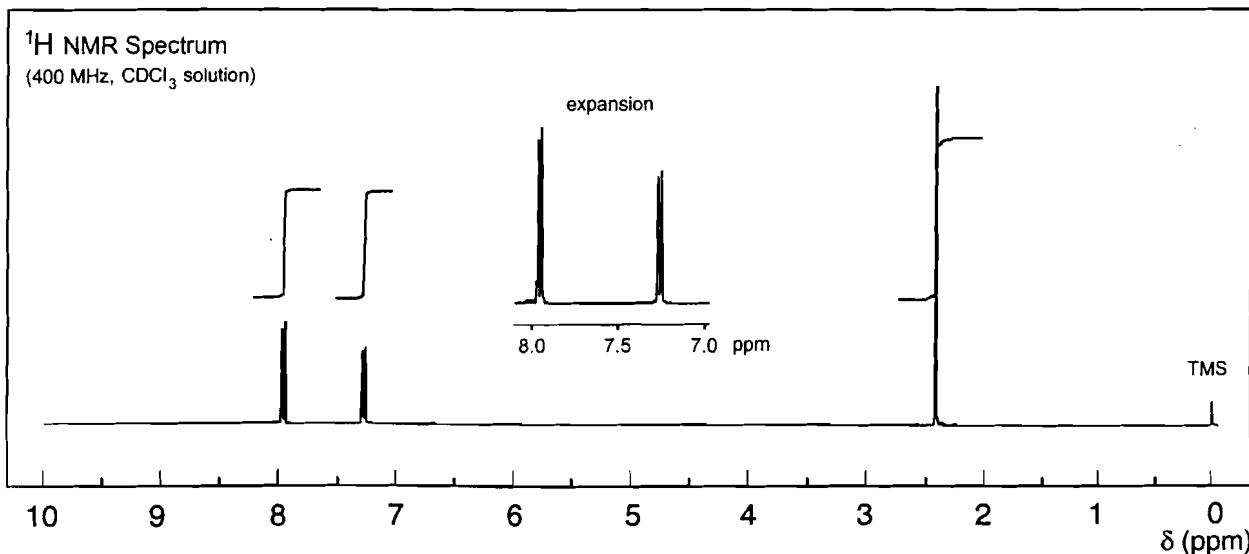
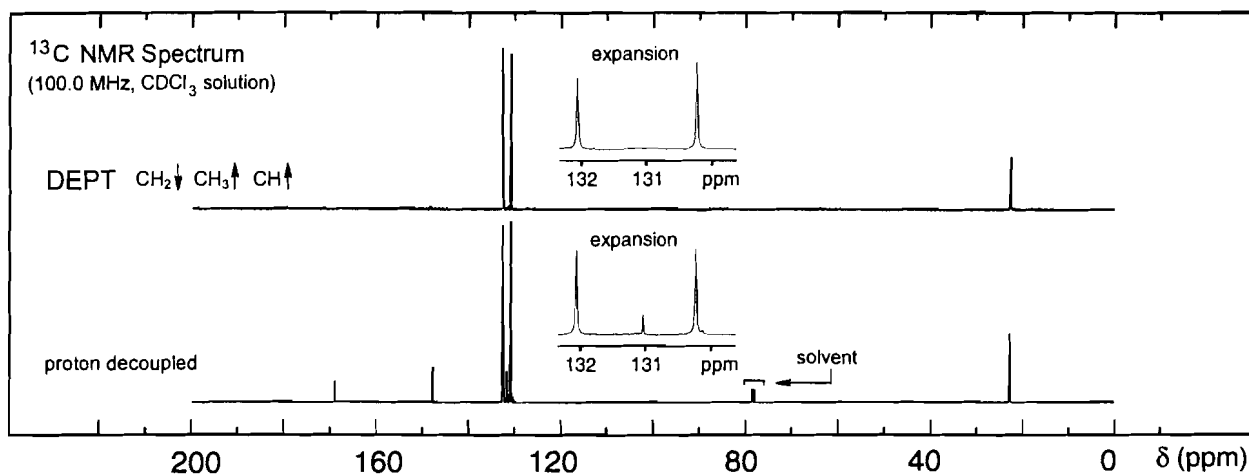



# Problem 103

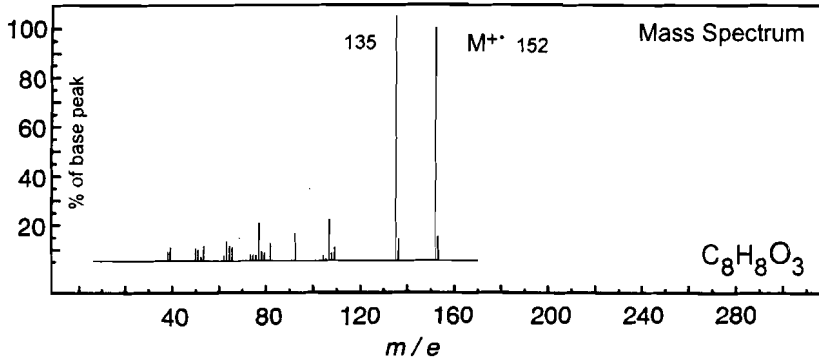
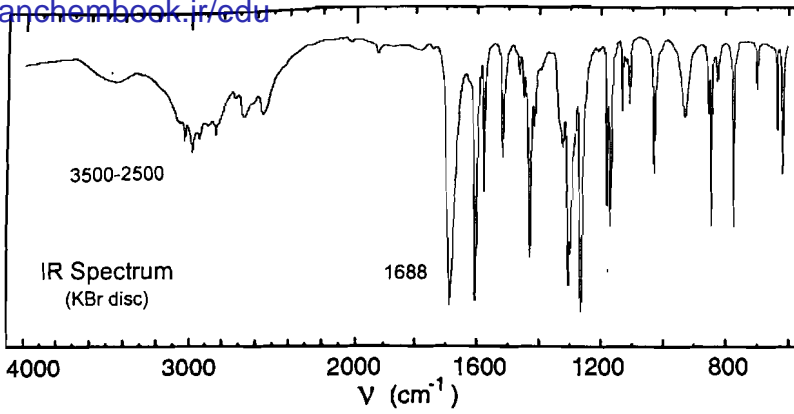

UV Spectrum

$$\lambda_{\text{max}} 224 \text{ nm } (\log_{10} \epsilon 3.4)$$

solvent: methanol

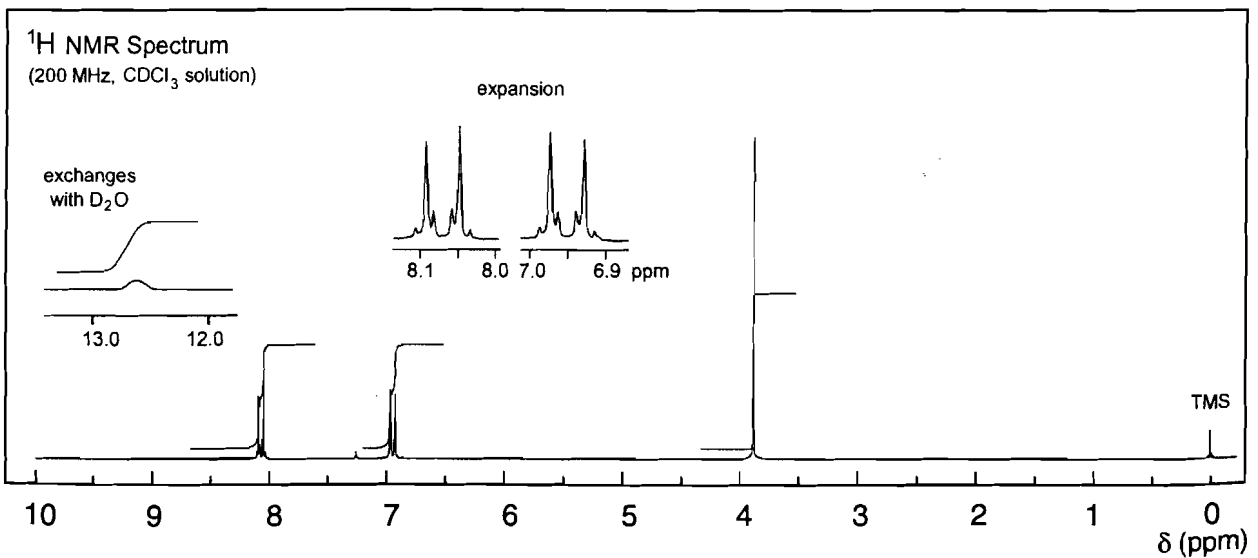
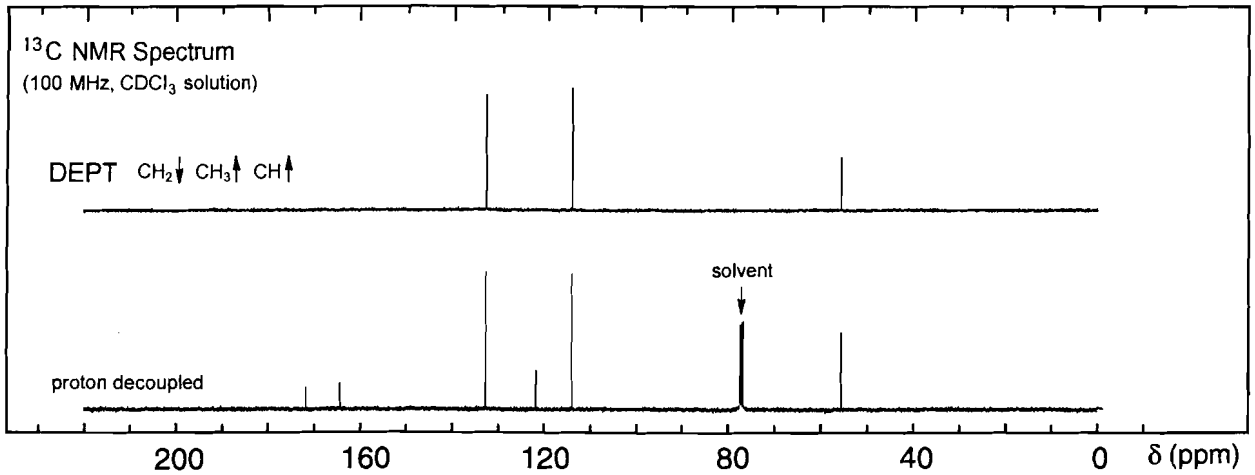

## Problem 104

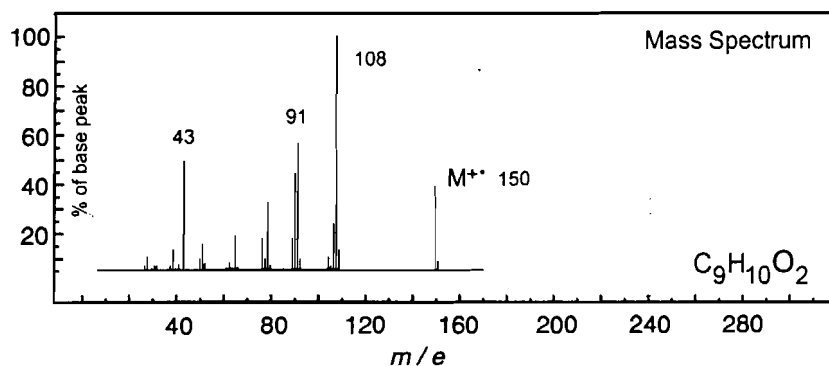
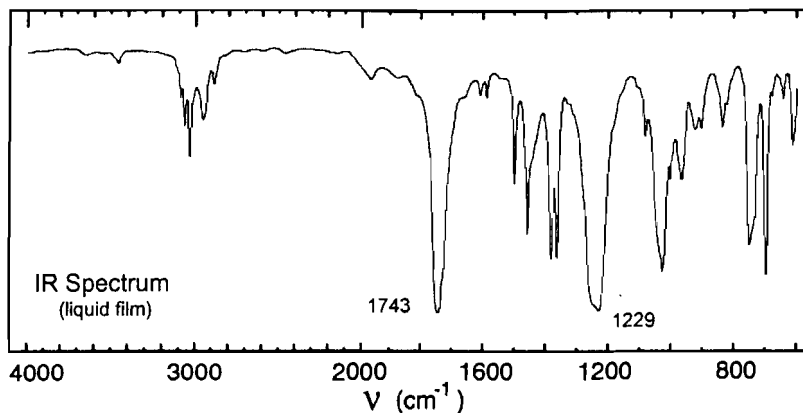

## UV Spectrum

 $\lambda_{\text{max}}$  252 nm ( $\log_{10} \epsilon$  2.2)

 $\lambda_{\text{max}}$  257 nm ( $\log_{10} \epsilon$  2.3)

 $\lambda_{\text{max}}$  262 nm ( $\log_{10} \epsilon$  2.2)

 $\lambda_{\text{max}}$  264 nm ( $\log_{10} \epsilon$  2.2)

 $\lambda_{\text{max}}$  268 nm ( $\log_{10} \epsilon$  2.0)

solvent : ethanol

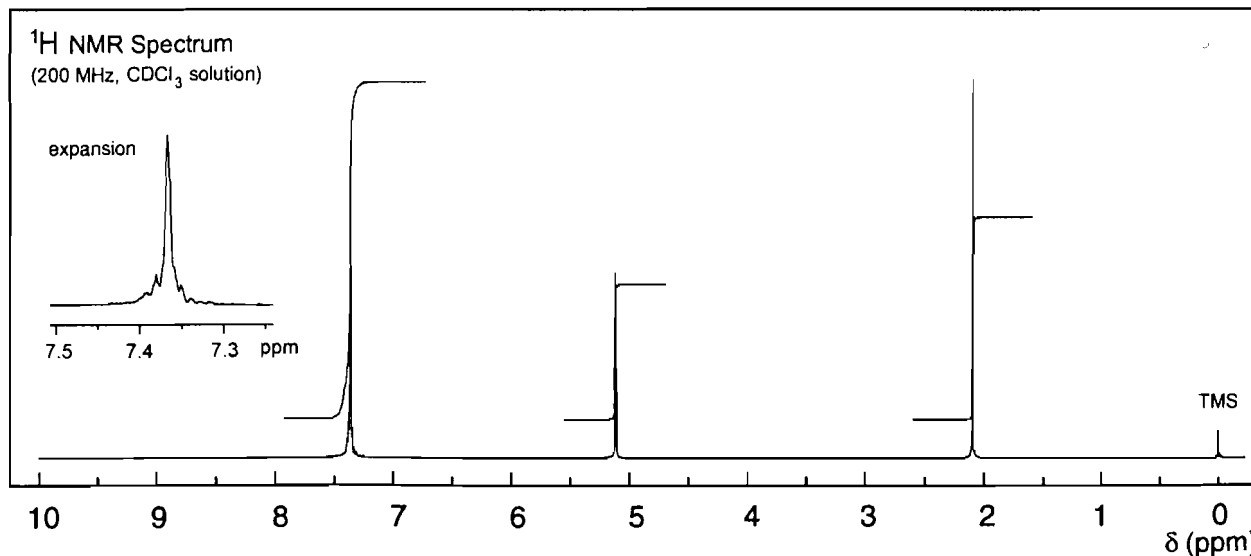
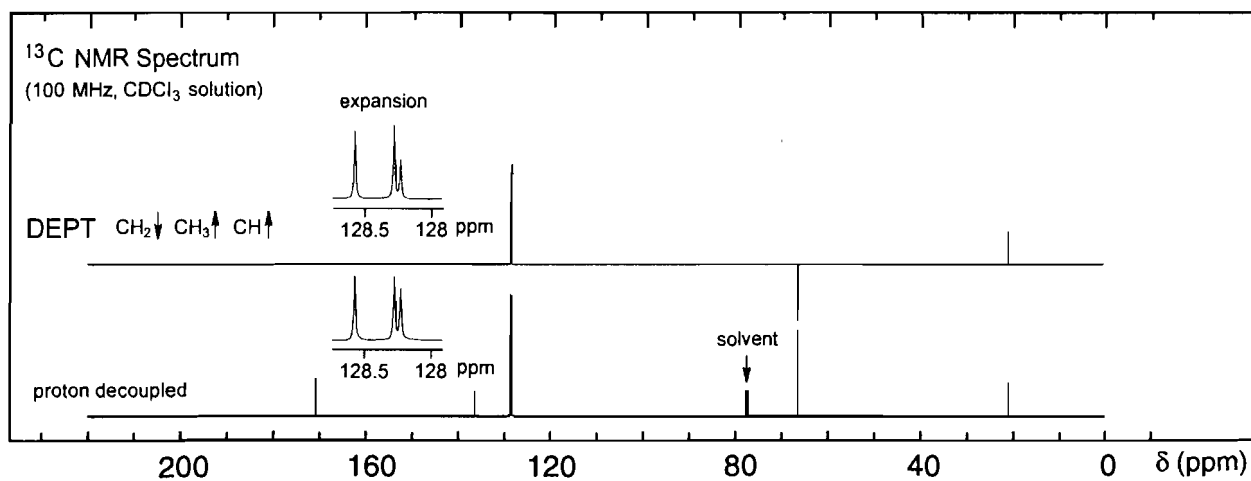

## Problem 105

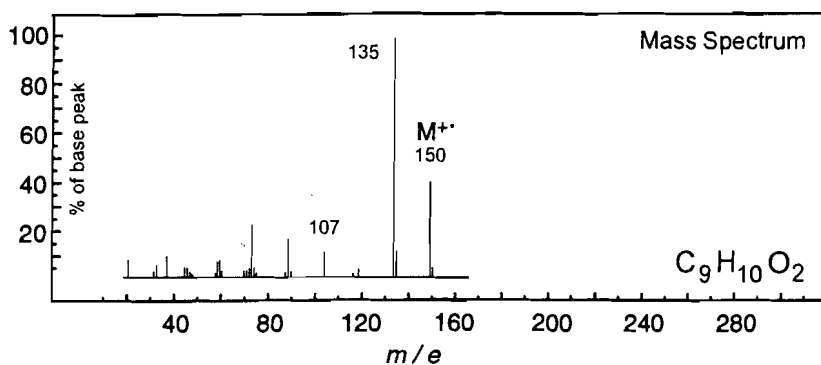
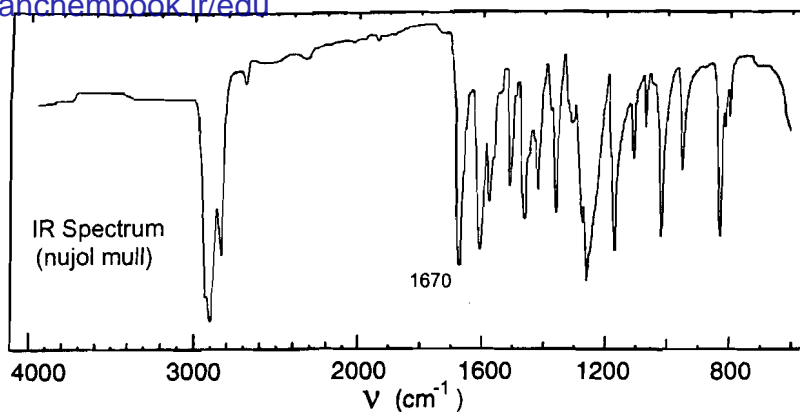

UV Spectrum

$$\lambda_{\max} 270 (\log_{10} \epsilon 4.2)$$

solvent : methanol

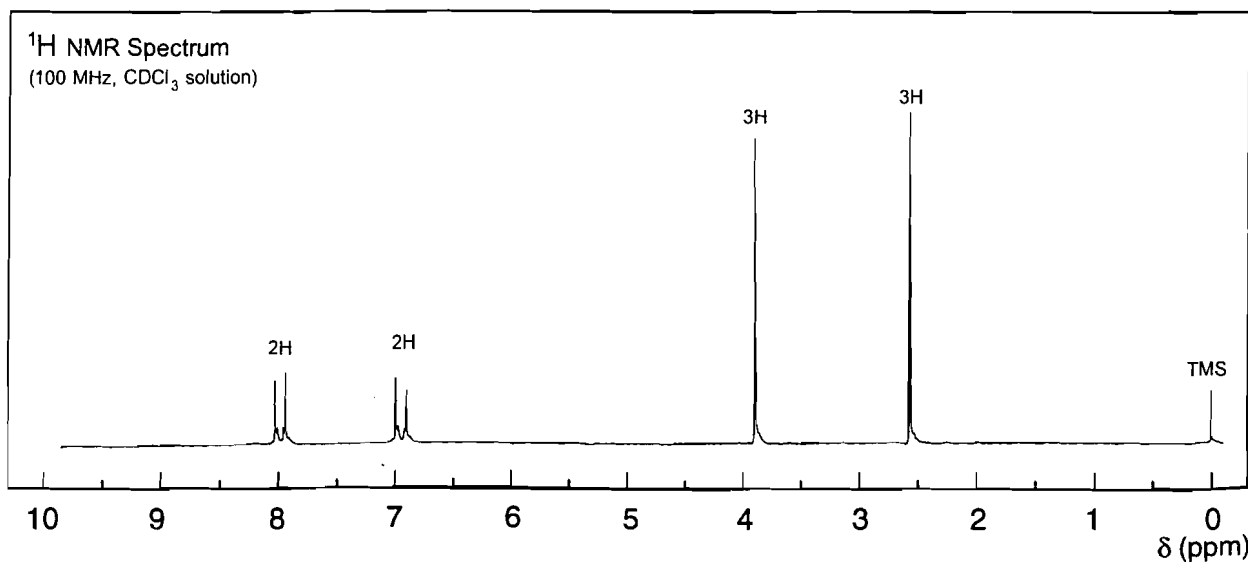
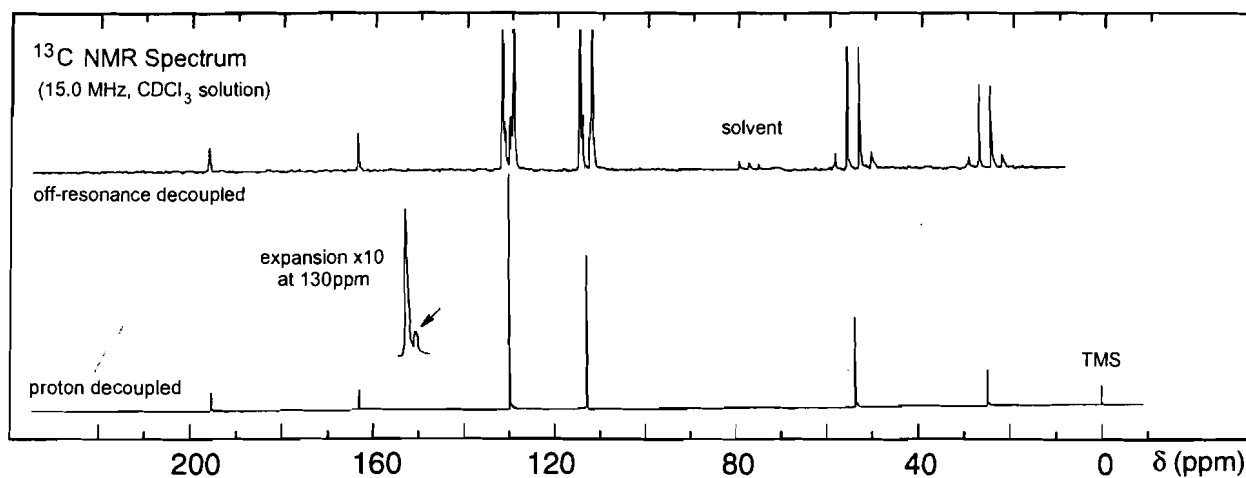

# Problem 106

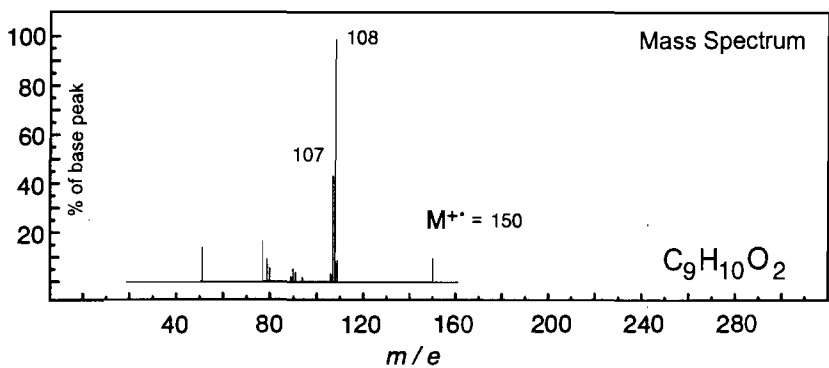
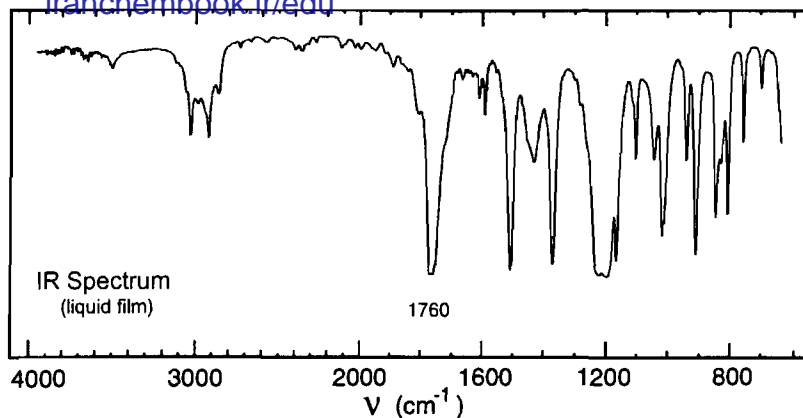

UV Spectrum

$\lambda_{\max} 265 \text{ nm (log}_{10}\epsilon 2.6)$

$\lambda_{\max} 271 \text{ nm (log}_{10}\epsilon 2.6)$

solvent : methanol

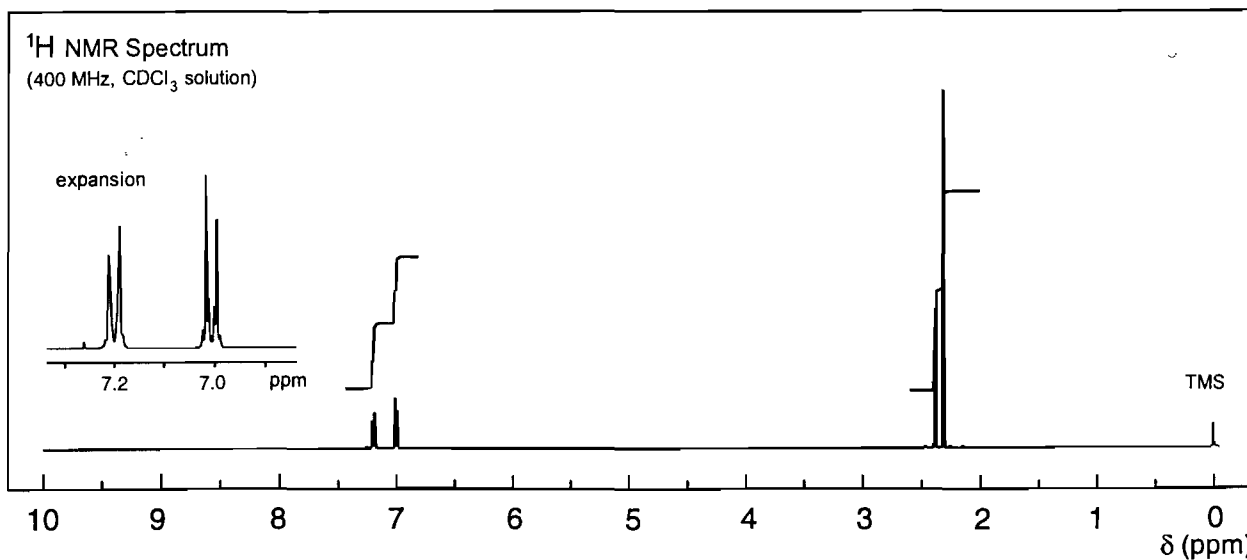
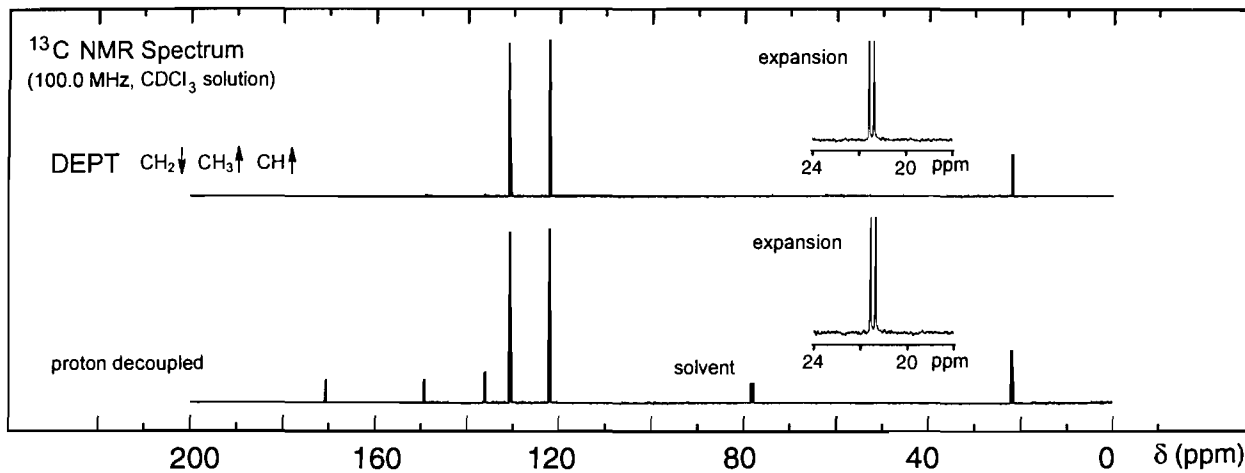

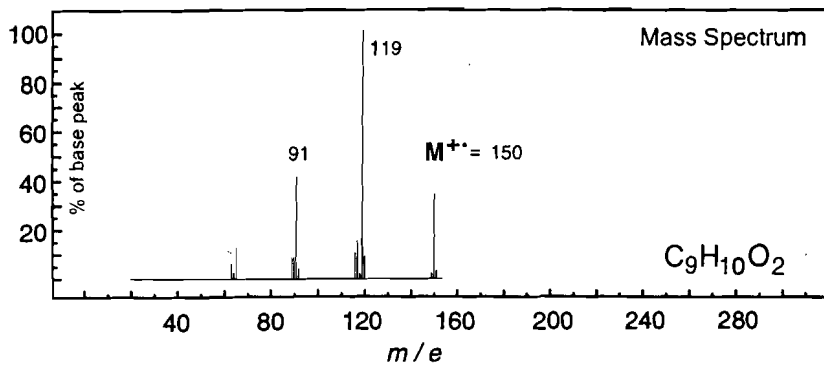
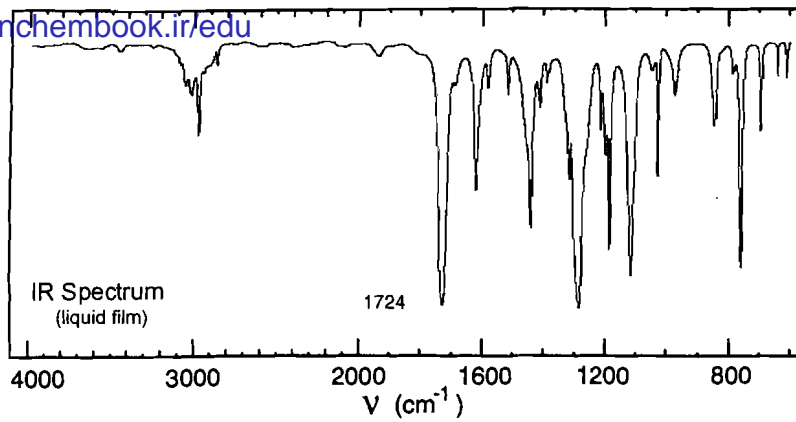

UV Spectrum

 $\lambda_{\text{max}}$  238 nm ( $\log_{10} \epsilon$  4.2) $\lambda_{\text{max}}$  281 nm ( $\log_{10} \epsilon$  2.7)

solvent: methanol

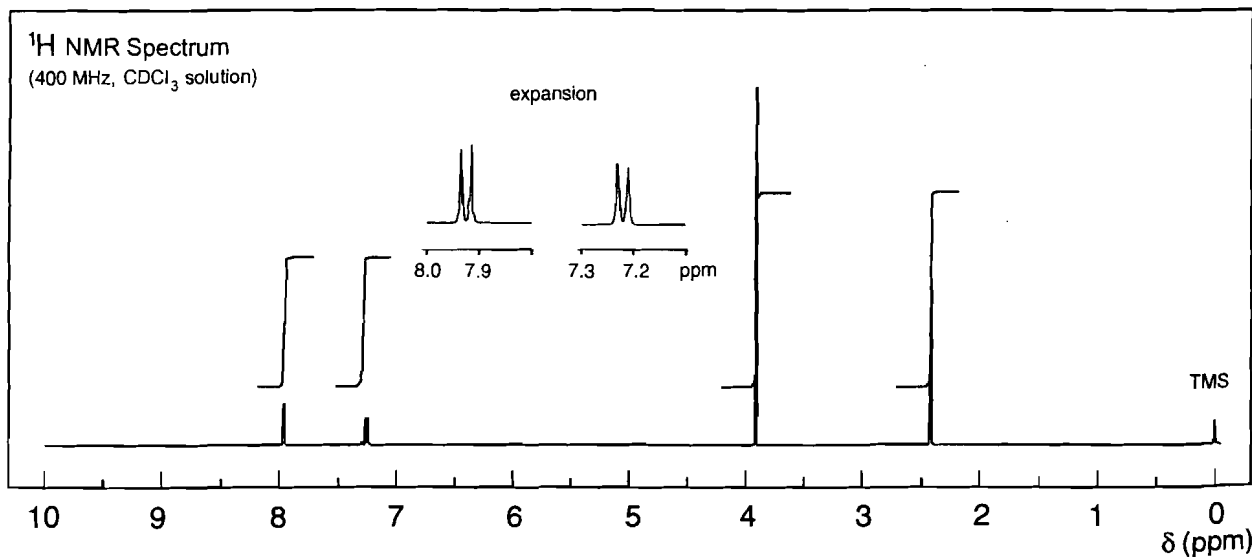
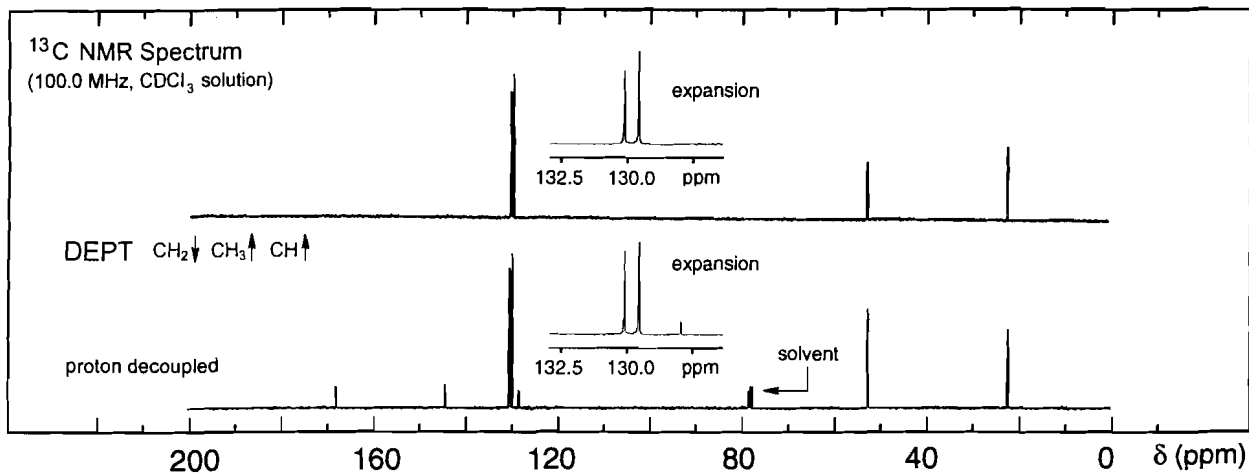

## Problem 108

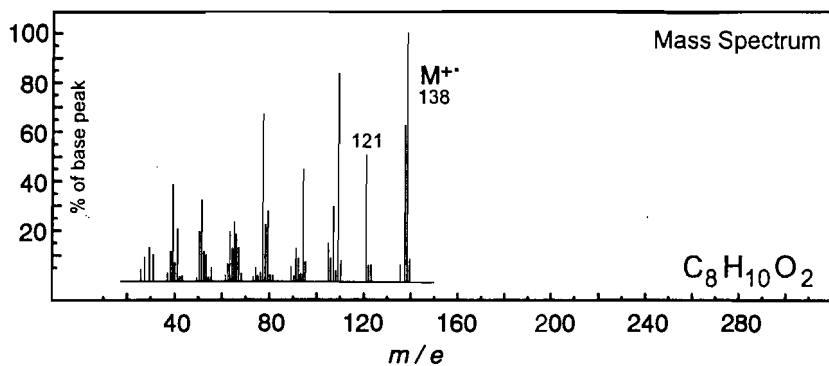
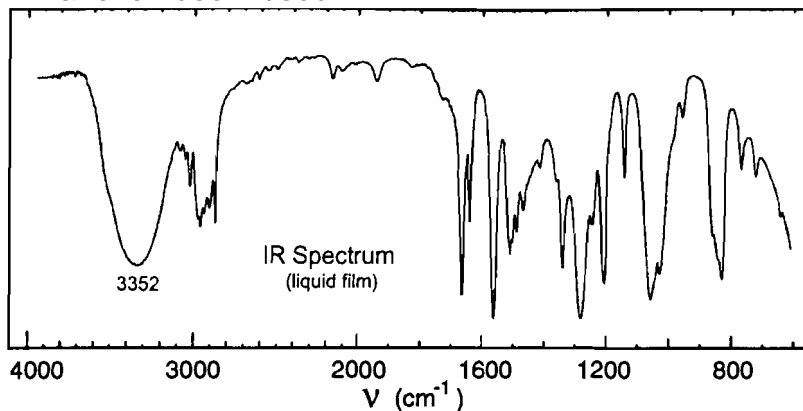

UV Spectrum

 $\lambda_{\text{max}}$  270 nm ( $\log_{10} \epsilon$  3.1) $\lambda_{\text{max}}$  282 nm ( $\log_{10} \epsilon$  3.1)

solvent : hexane

Note: UV spectrum not changed significantly on addition of base

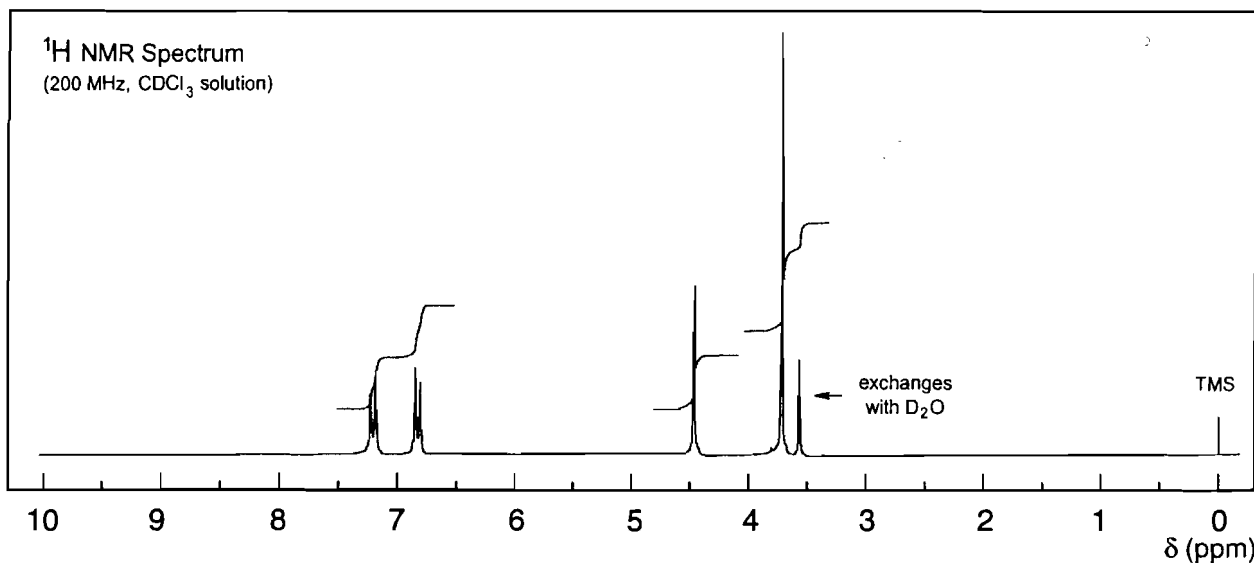
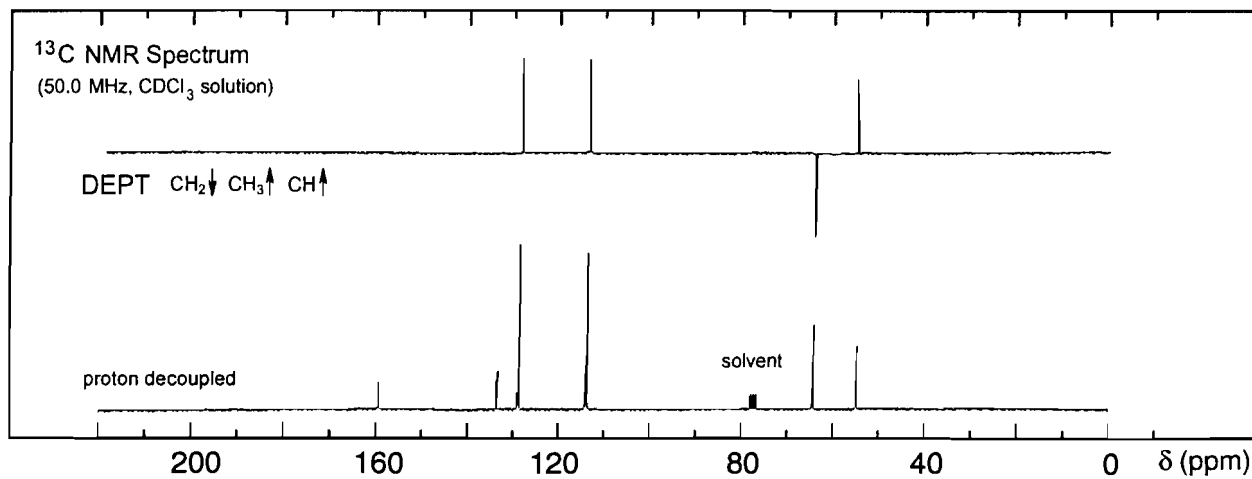

## Problem 109

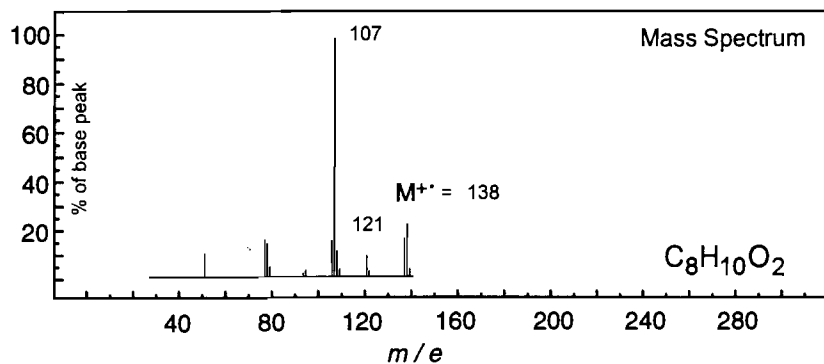
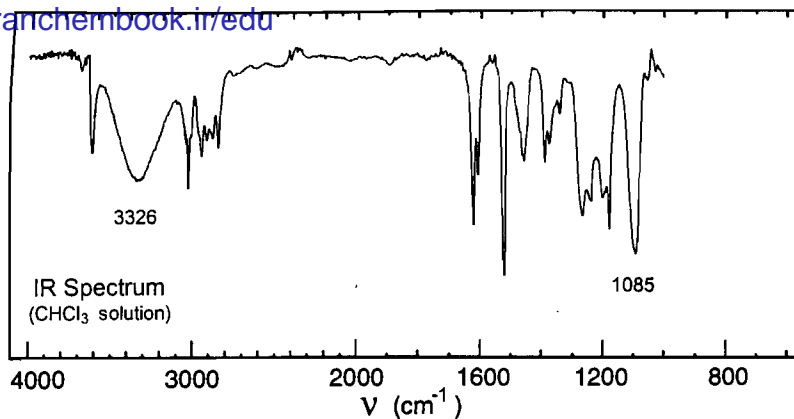

UV Spectrum

$$\log_{10} \epsilon \approx 3 - 4$$

Note: UV spectrum changed significantly on addition of base

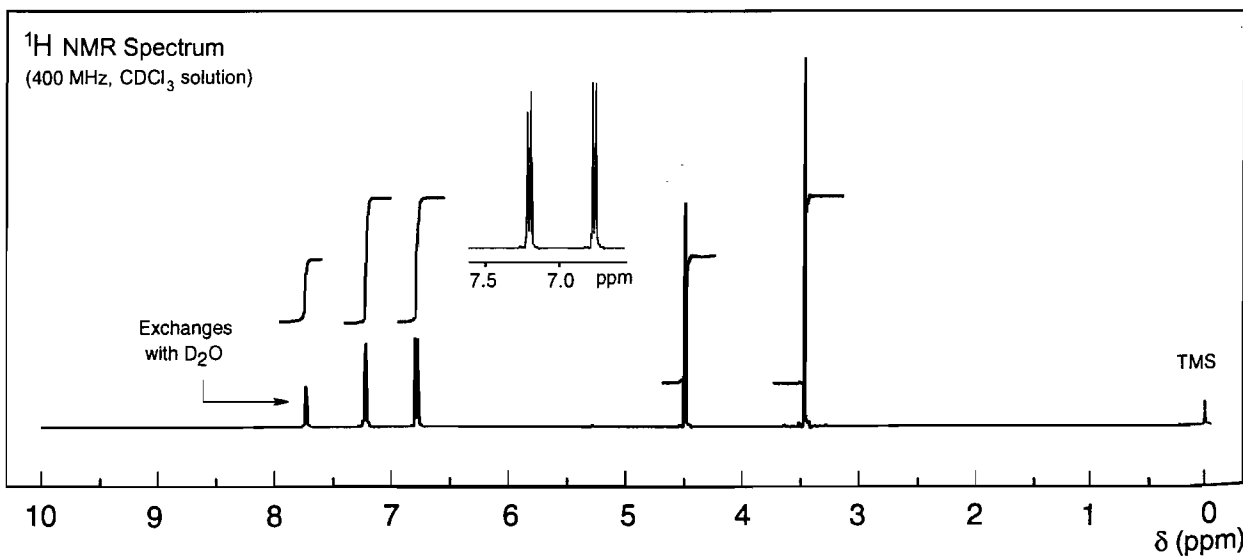
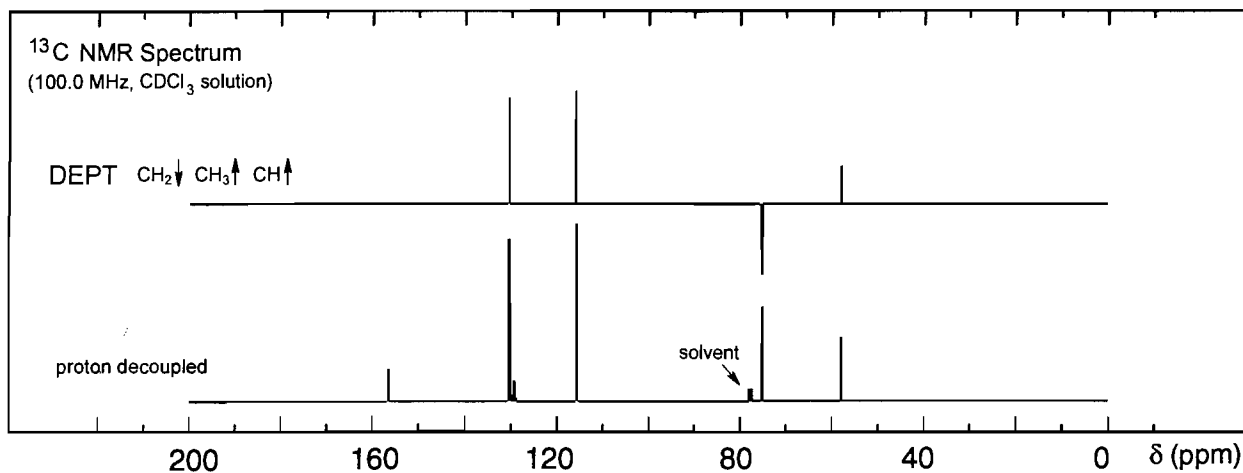

## Problem 110

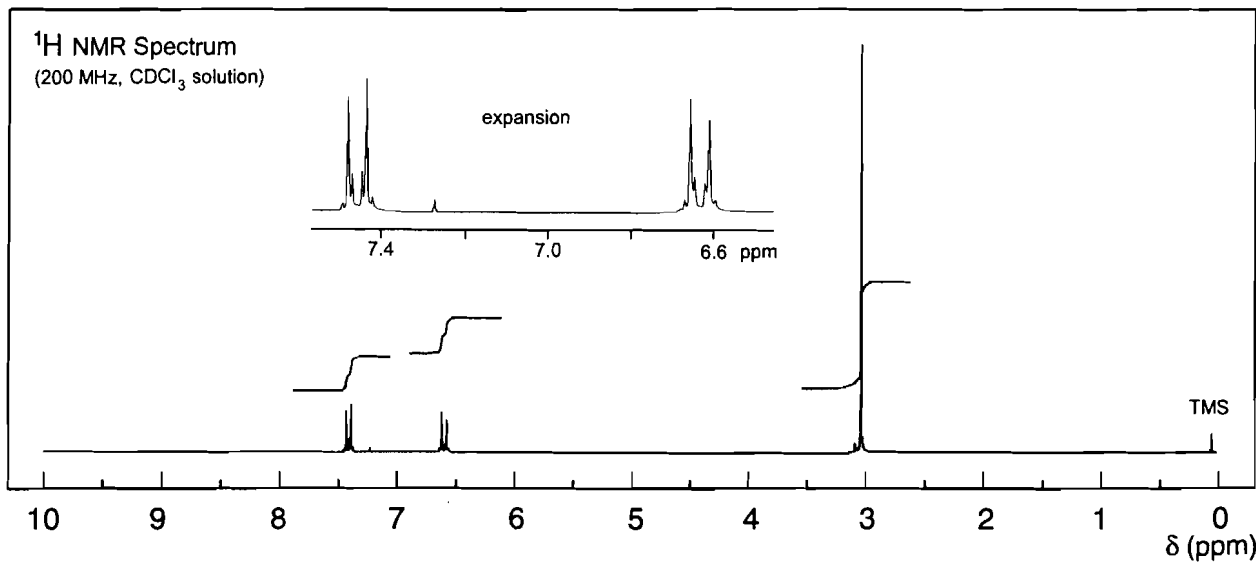
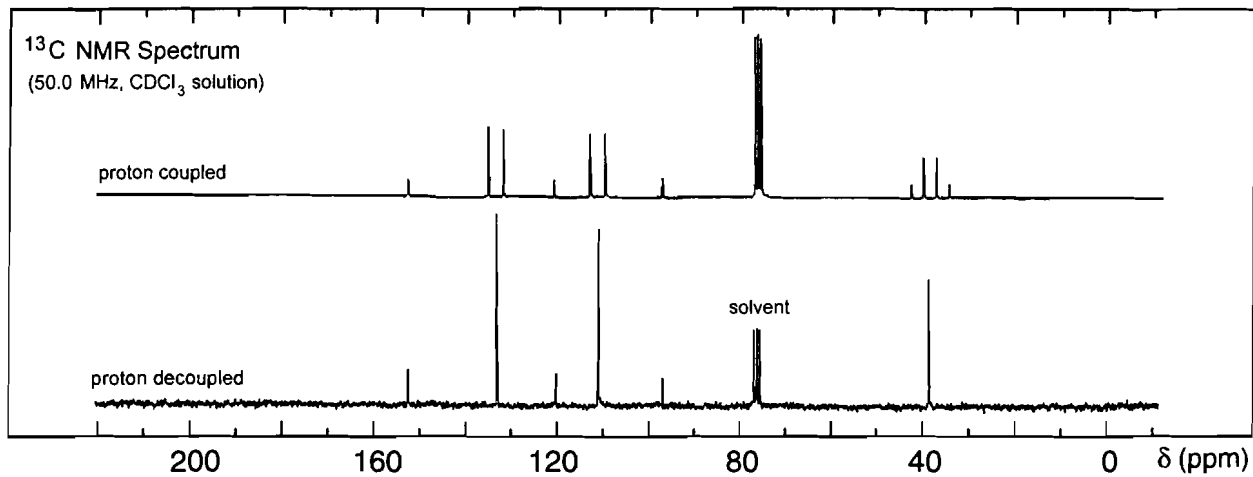
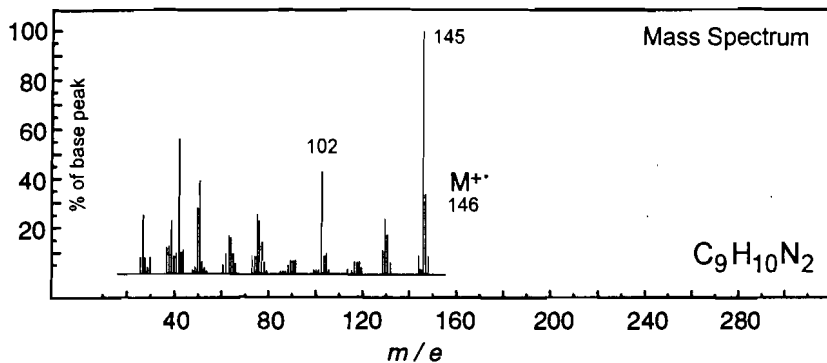
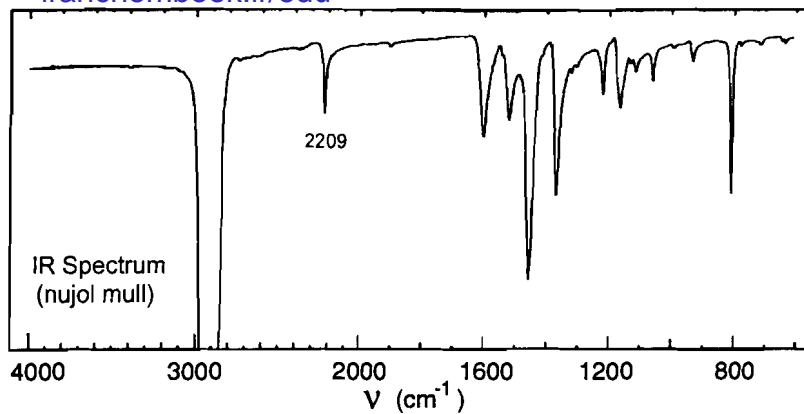



## Problem 111

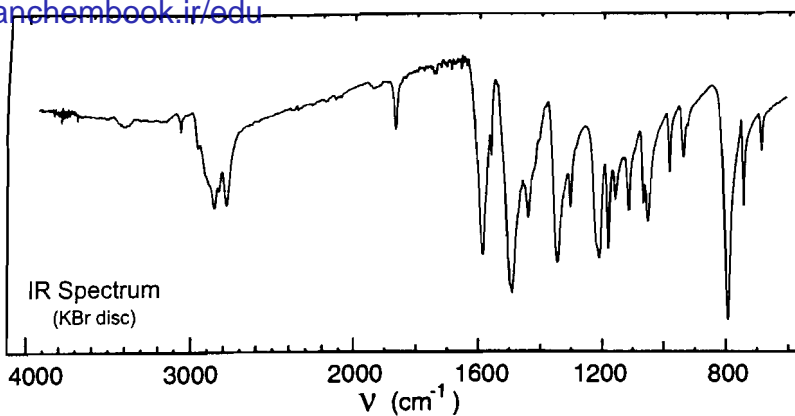

UV Spectrum

 $\lambda_{\max}$  310 nm ( $\log_{10} \epsilon$  3.3) $\lambda_{\max}$  261 nm ( $\log_{10} \epsilon$  4.3)

solvent : methanol

 $\lambda_{\max}$  262 nm ( $\log_{10} \epsilon$  3.0) $\lambda_{\max}$  257 nm ( $\log_{10} \epsilon$  3.0) $\lambda_{\max}$  222 nm ( $\log_{10} \epsilon$  4.0)

solvent : methanol / HCl

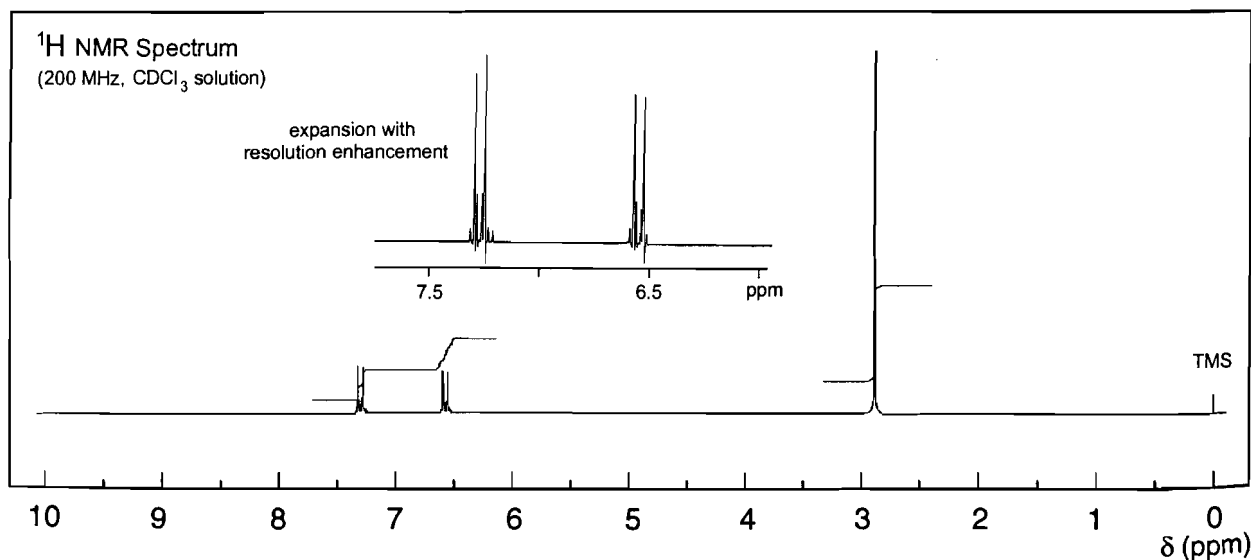
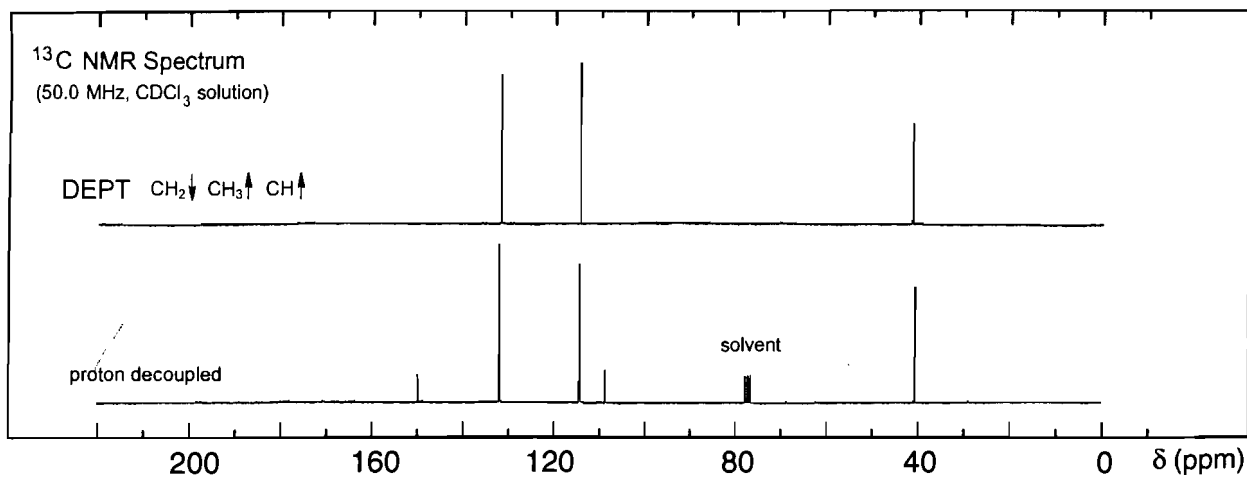
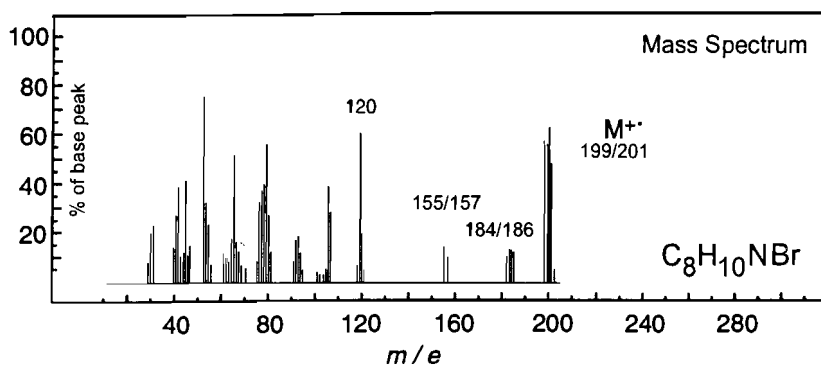

## Problem 112

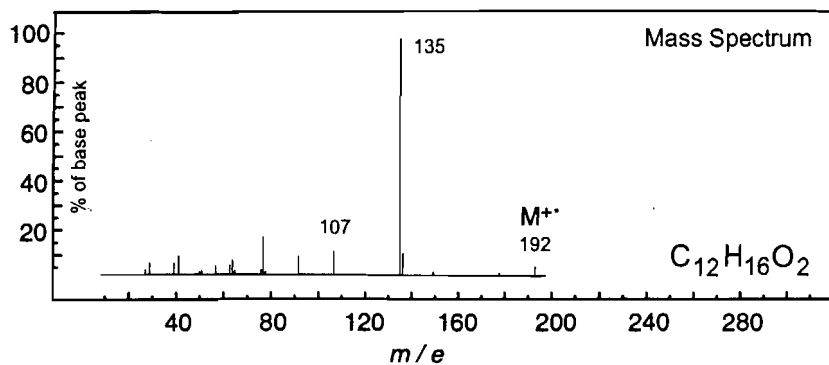
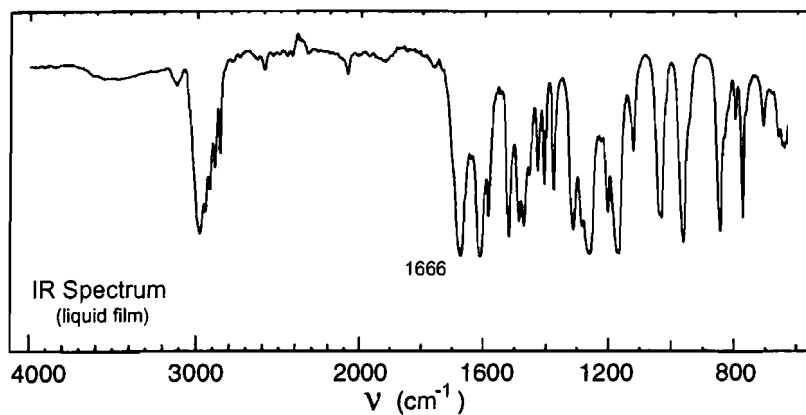

UV Spectrum

$$\log_{10} \epsilon \approx 4$$

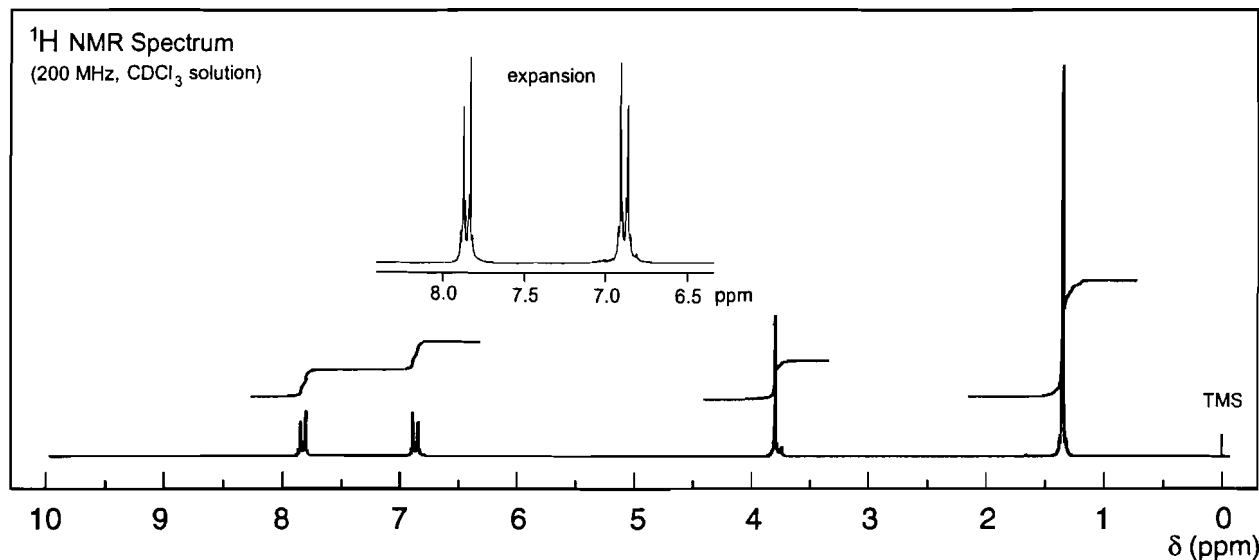
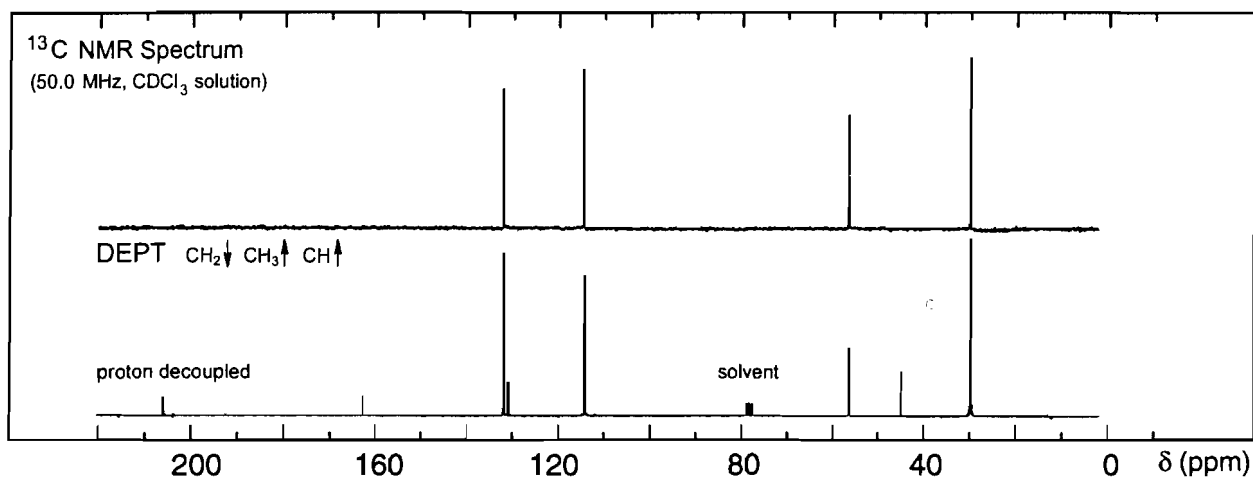

# Problem 113

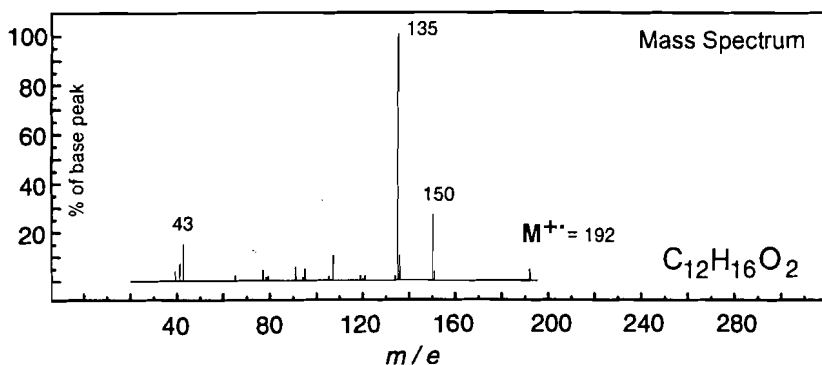
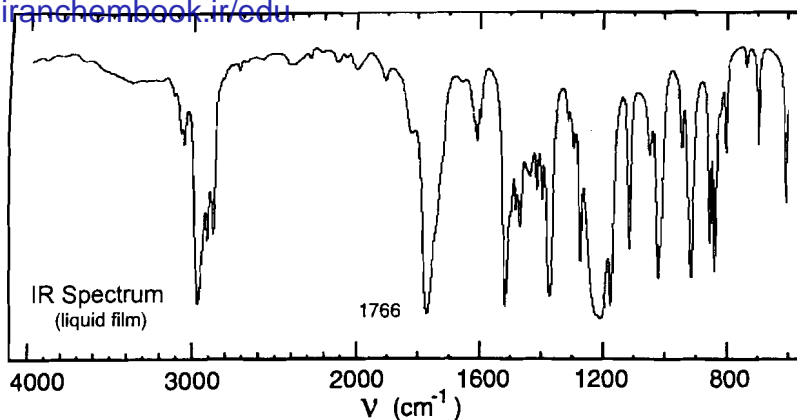

UV Spectrum

$\lambda_{\max} 262 \text{ nm (log}_{10}\epsilon 2.6)$

$\lambda_{\max} 269 \text{ nm (log}_{10}\epsilon 2.6)$

solvent : methanol

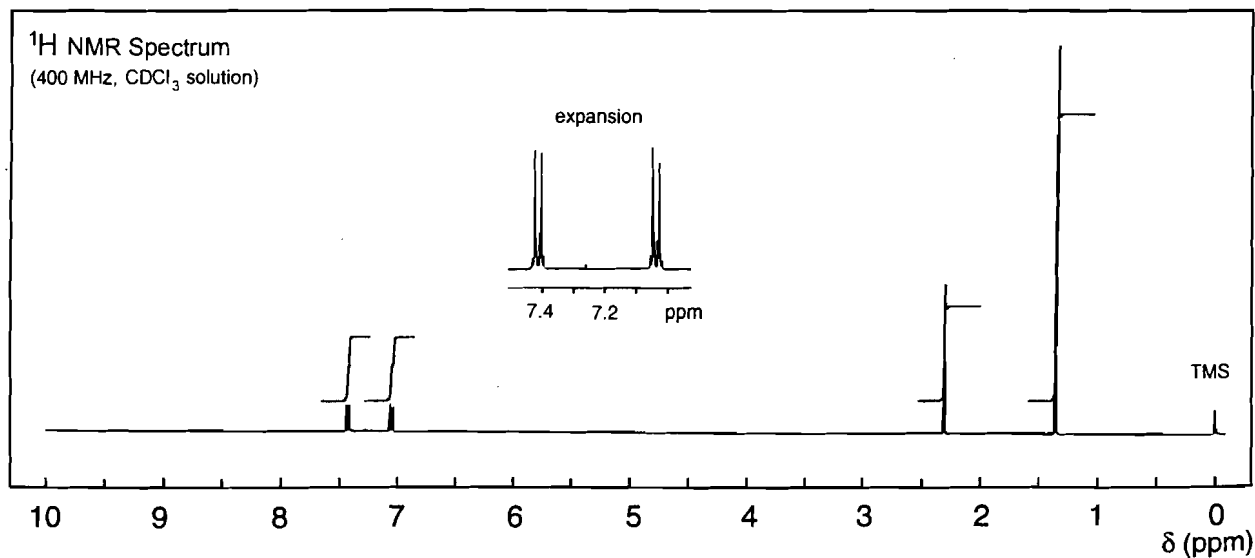
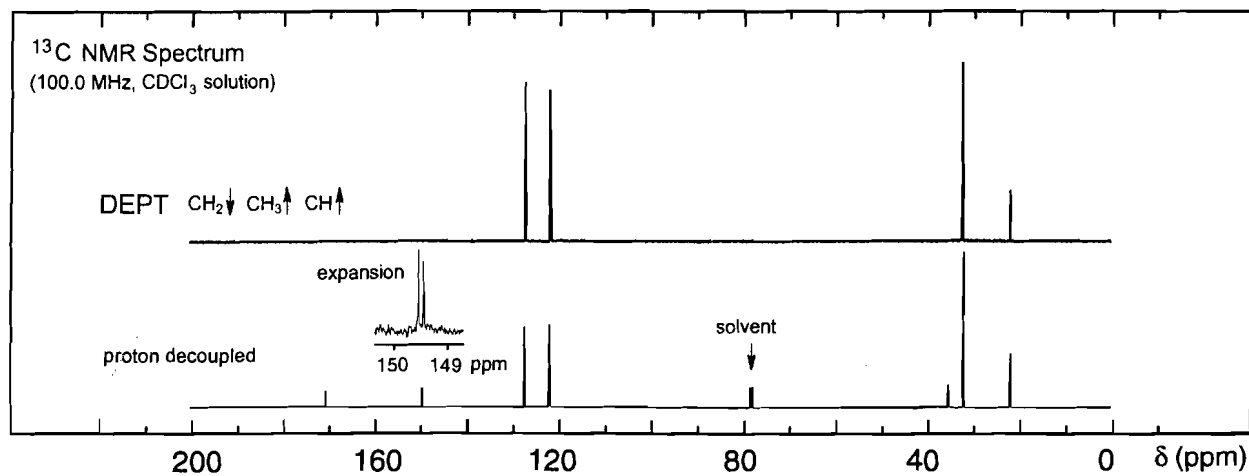

## Problem 114

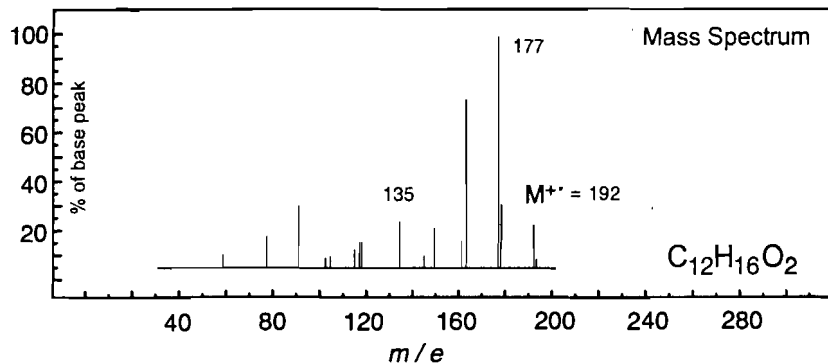
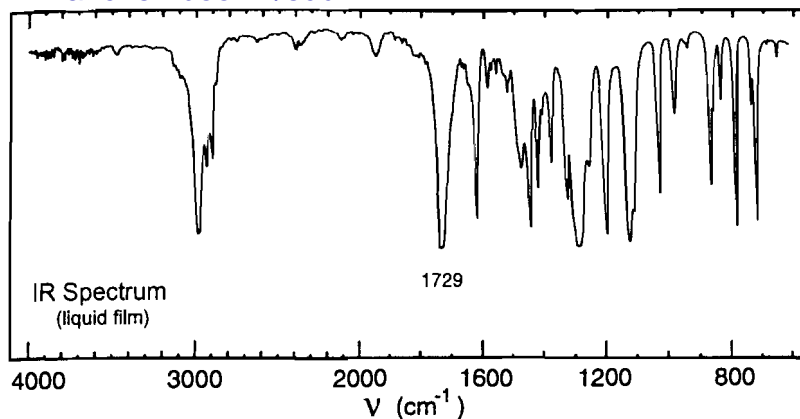

UV Spectrum

$$\lambda_{\text{max}} \approx 240 \text{ nm } (\log_{10} \epsilon > 4.0)$$

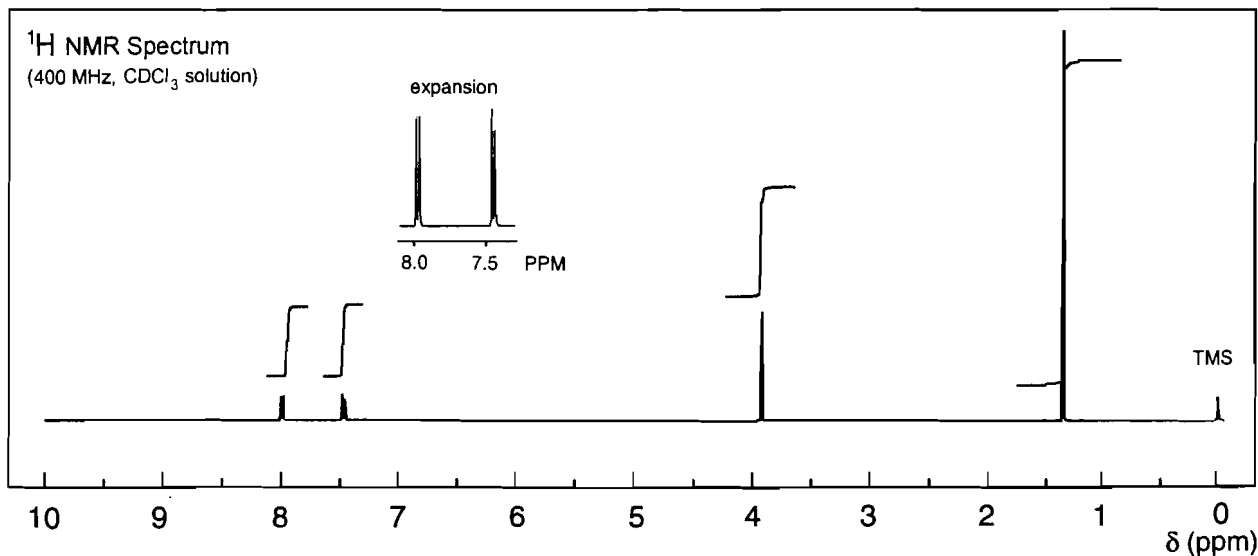
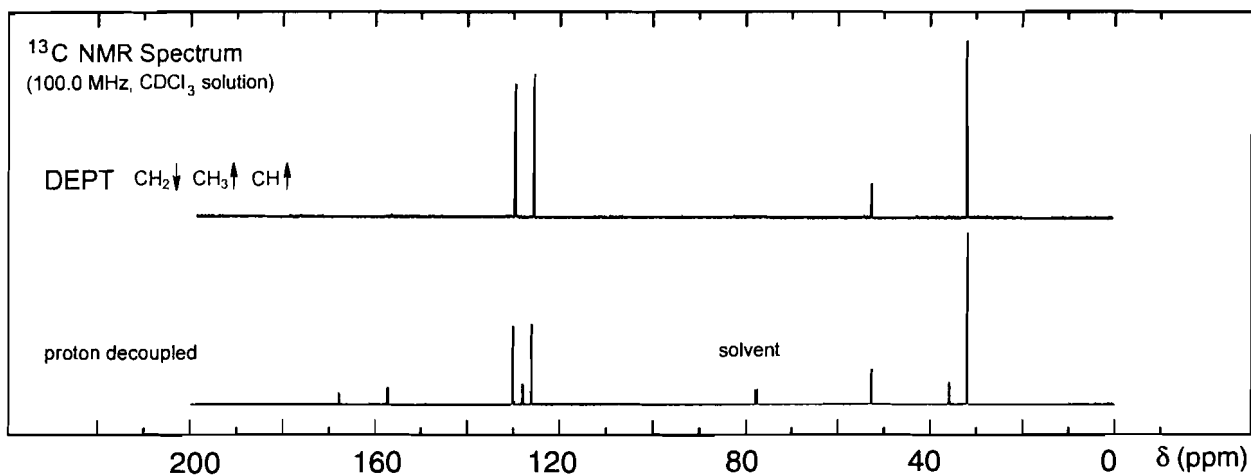

## Problem 115

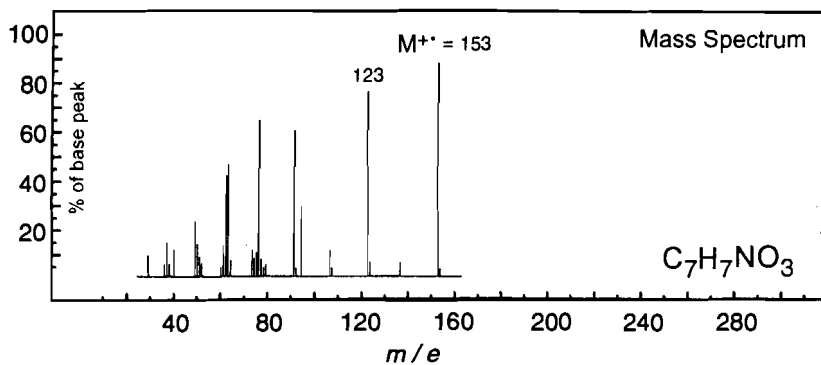
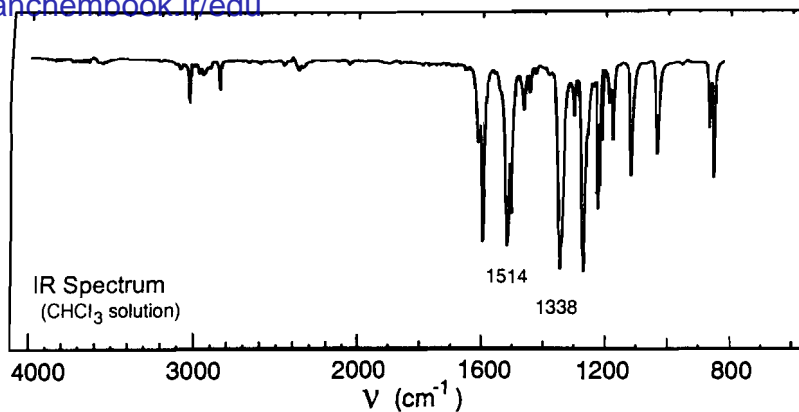

UV Spectrum

 $\lambda_{\max}$  227 nm ( $\log_{10} \epsilon$  3.9) $\lambda_{\max}$  305 nm ( $\log_{10} \epsilon$  4.0)

solvent : methanol

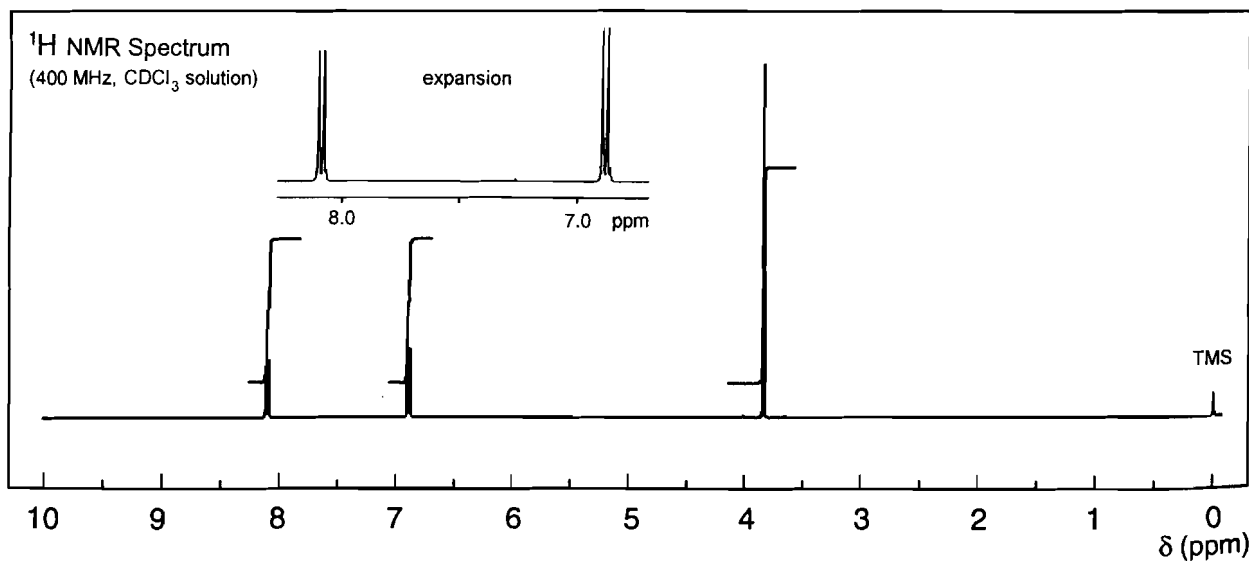
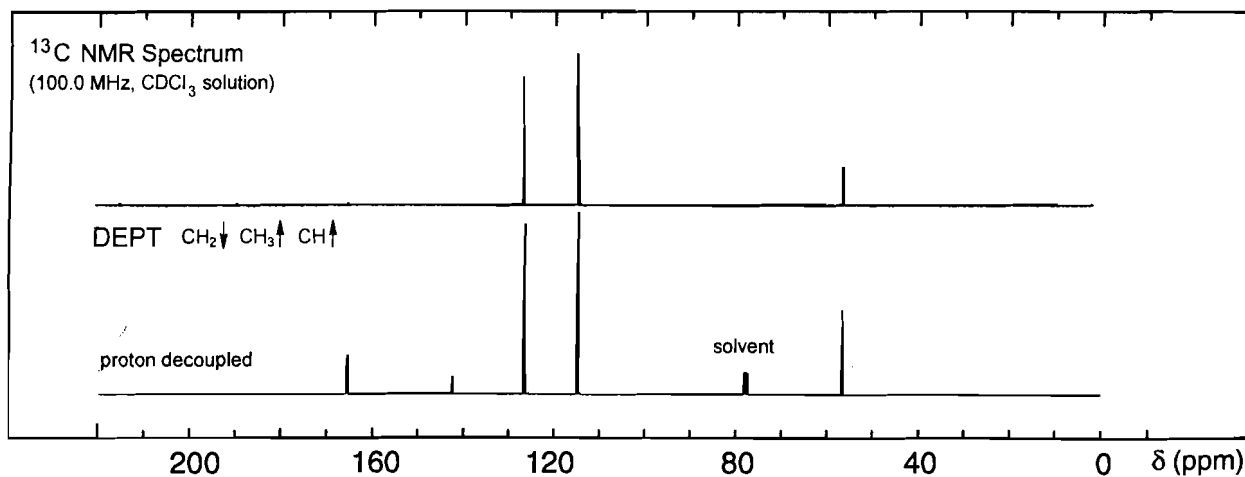

## Problem 116

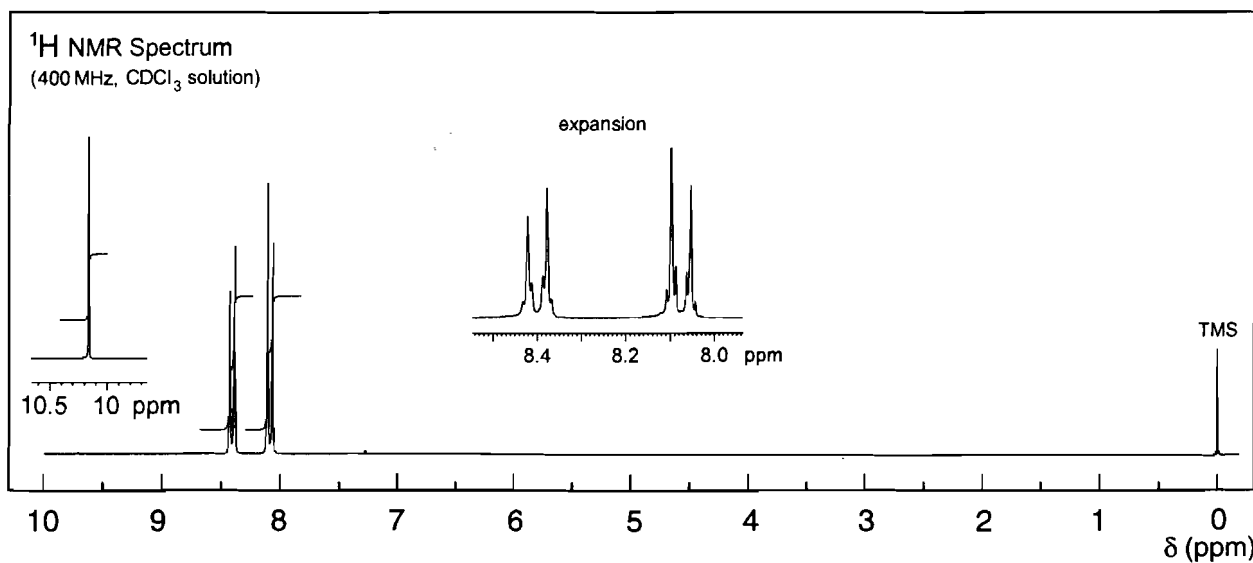
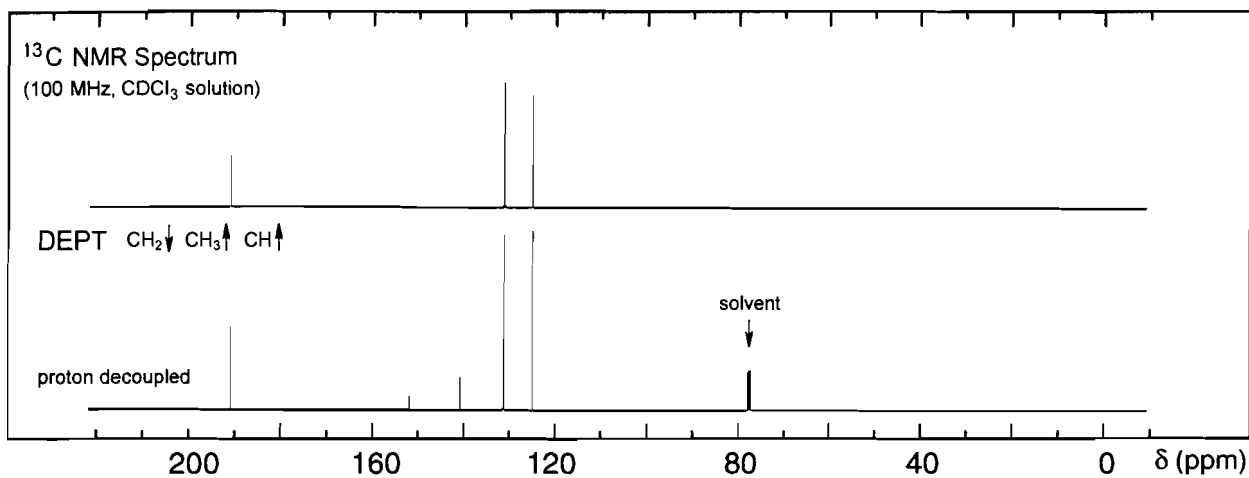
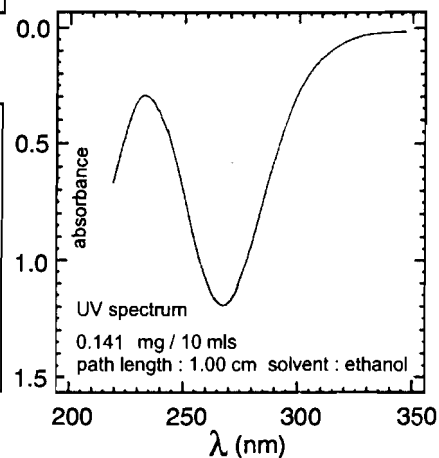
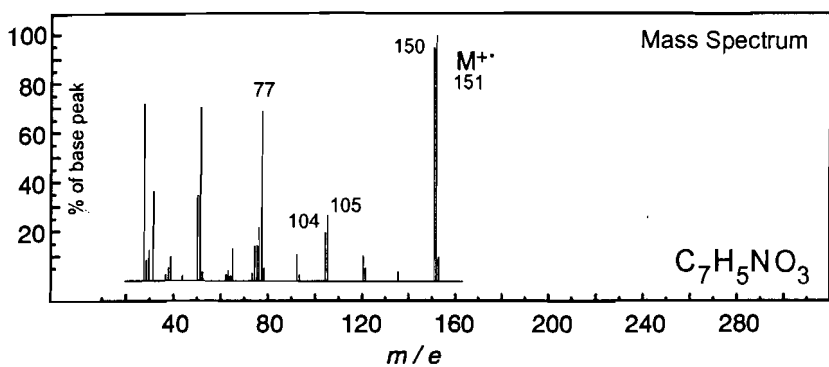
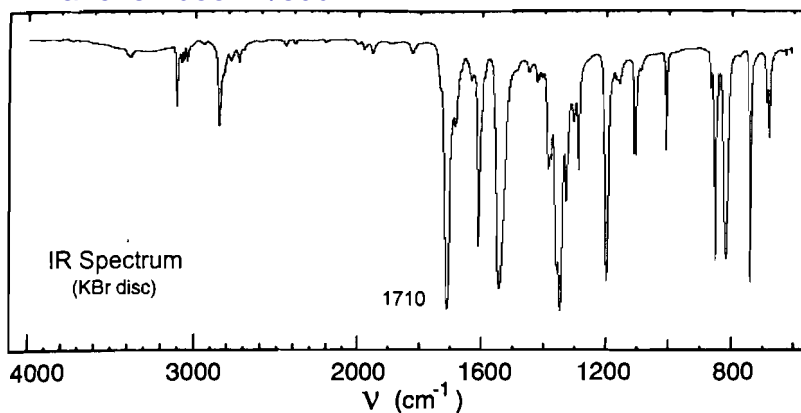

## Problem 117

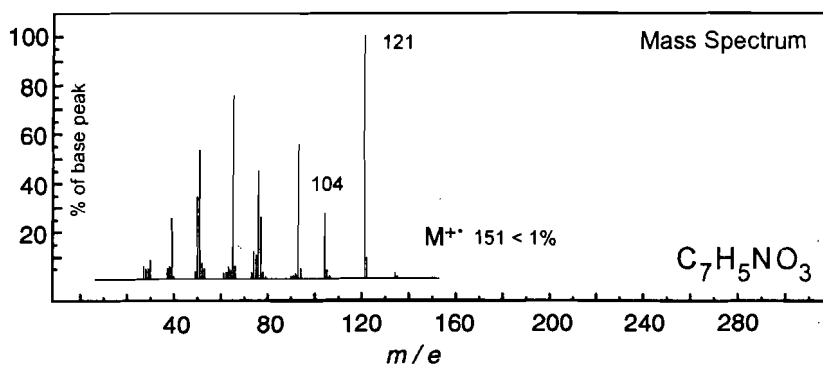
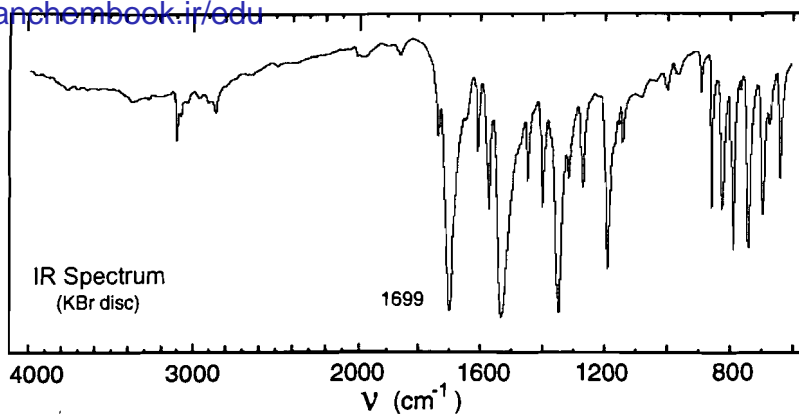

UV Spectrum

 $\lambda_{\text{max}}$  225 nm ( $\log_{10} \epsilon$  4.2) $\lambda_{\text{max}}$  250 nm ( $\log_{10} \epsilon$  3.8) $\lambda_{\text{max}}$  293 nm ( $\log_{10} \epsilon$  3.2) $\lambda_{\text{max}}$  330 nm ( $\log_{10} \epsilon$  2.6)

solvent : methanol

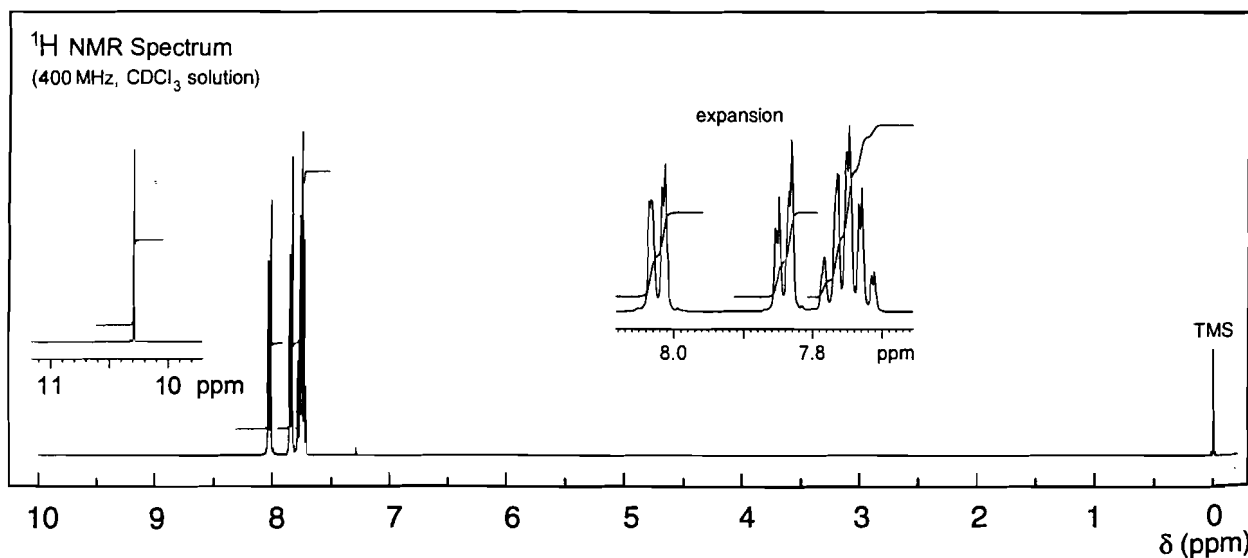
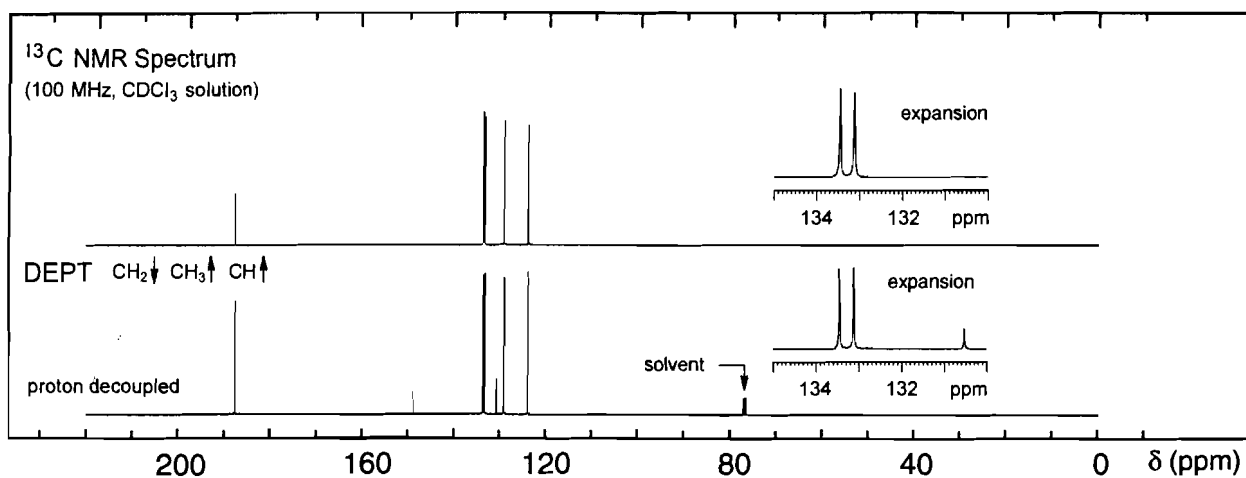

## Problem 118

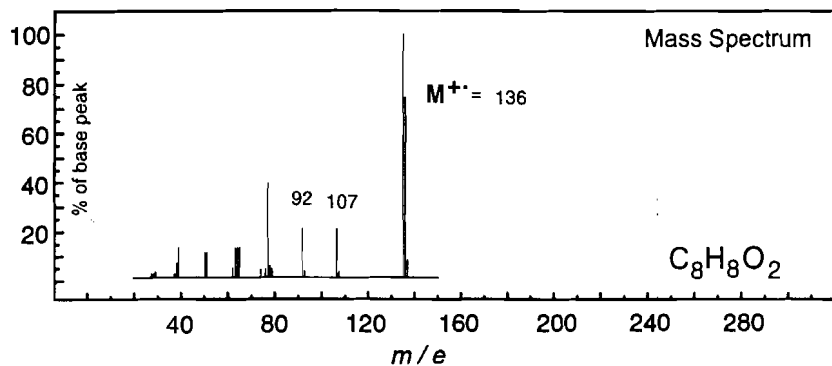
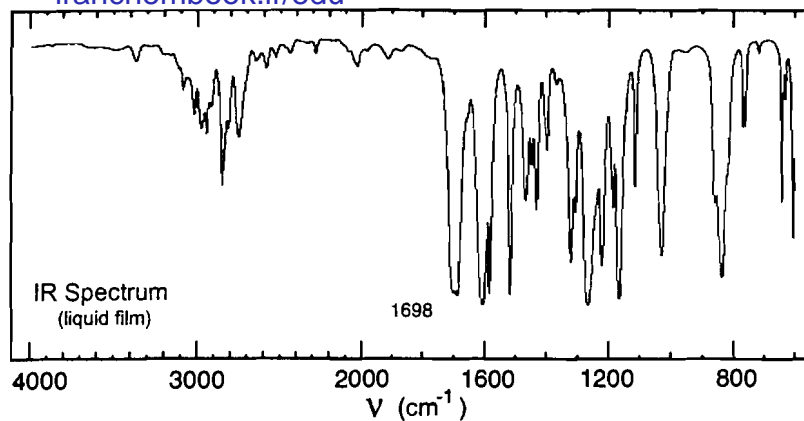

UV Spectrum

 $\lambda_{\text{max}} 277 \text{ nm}$  ( $\log_{10} \epsilon 4.2$ )

solvent: methanol

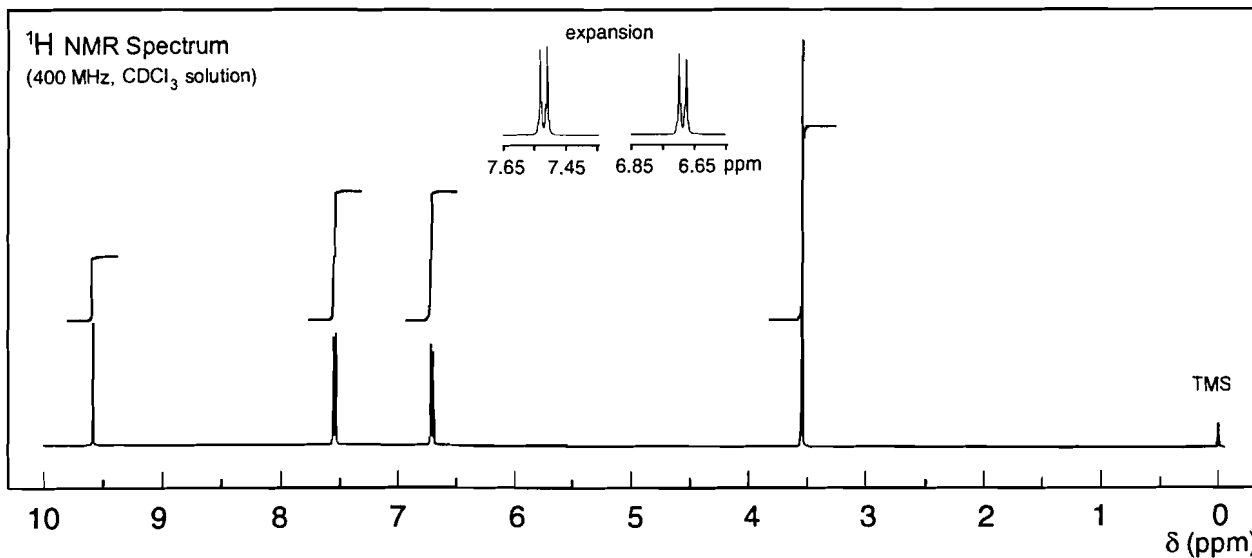
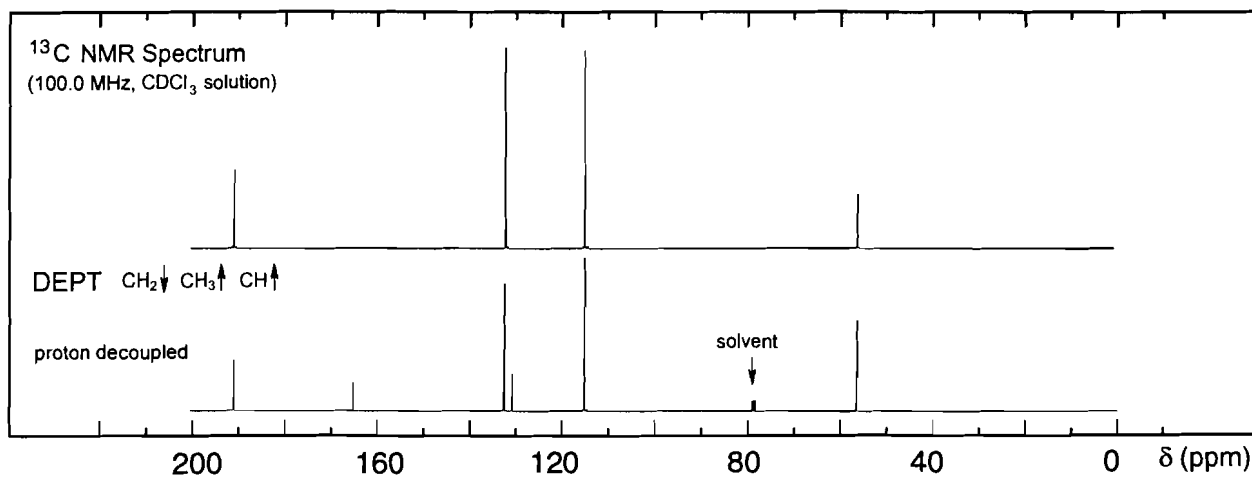



## Problem 119

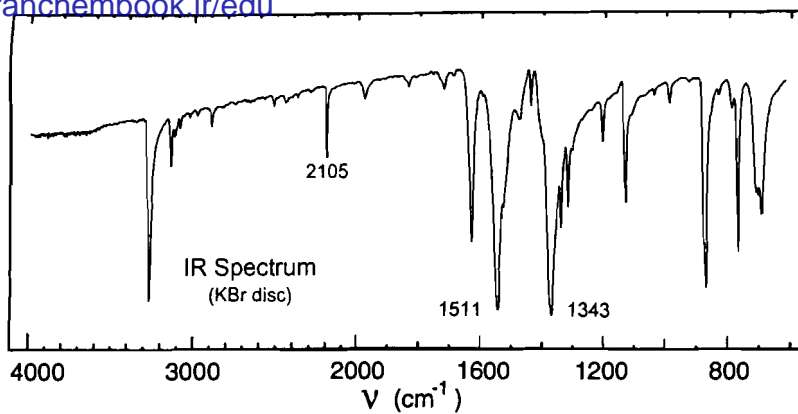

UV Spectrum

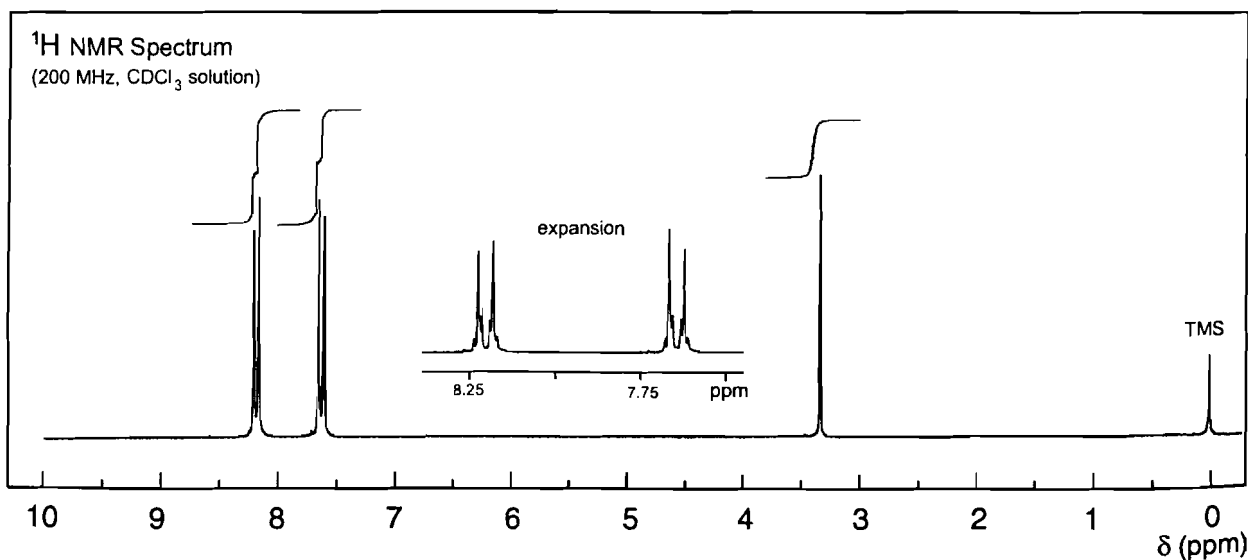
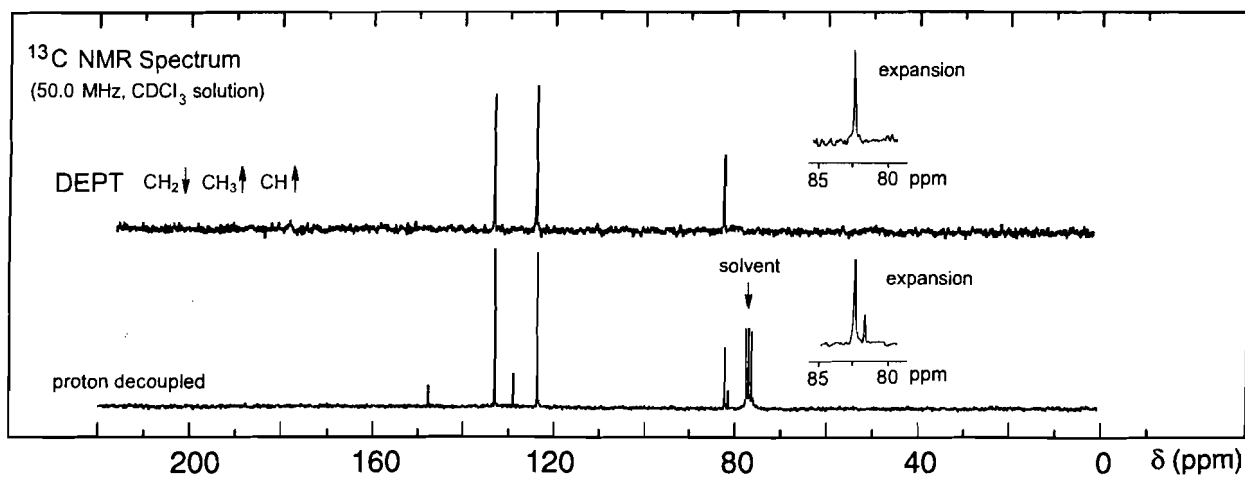
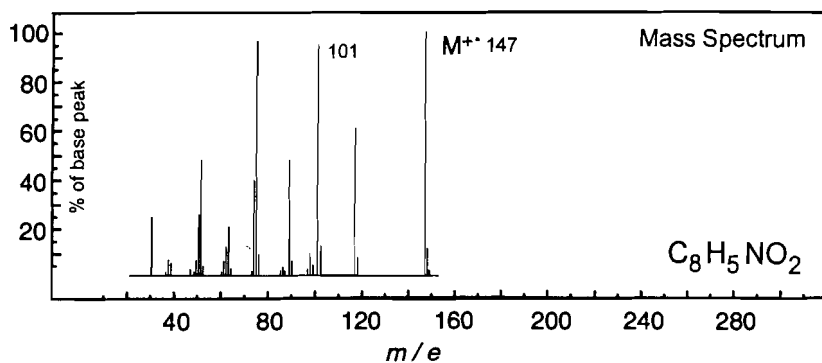
 $\log_{10} \epsilon > 4$ 

# Problem 120

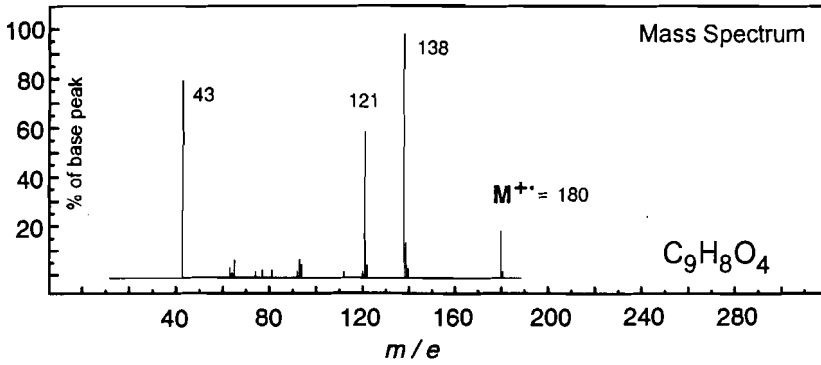
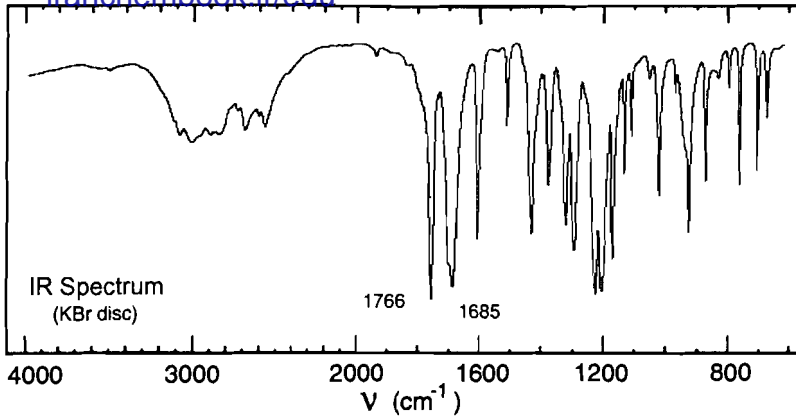

UV Spectrum

$\lambda_{\max} 235 \text{ nm (log}_{10}\epsilon 4.1)$

$\lambda_{\max} 265 \text{ nm (log}_{10}\epsilon 3.0)$

solvent: ethanol

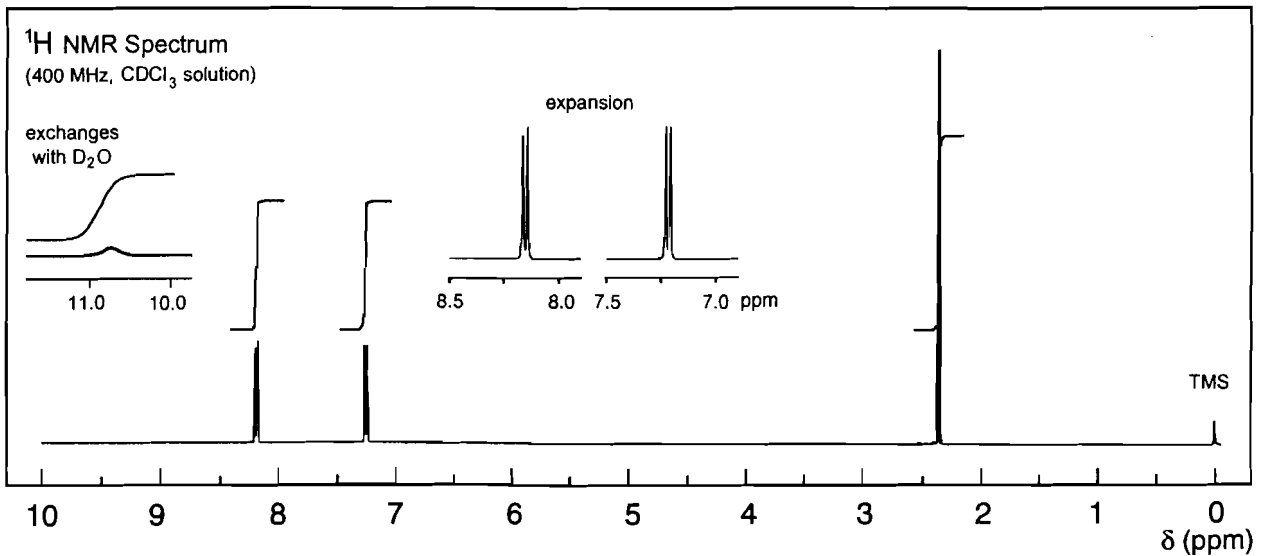
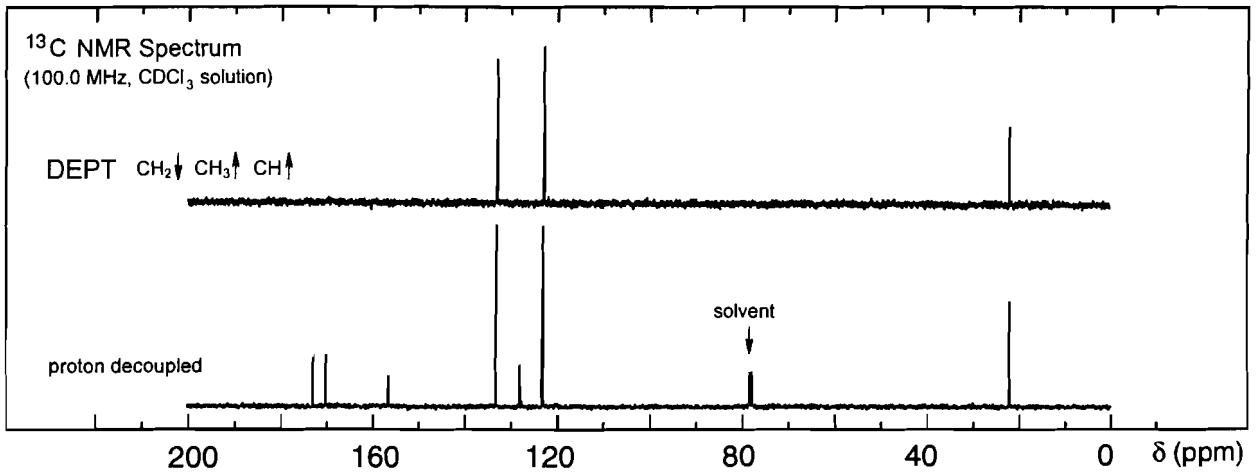

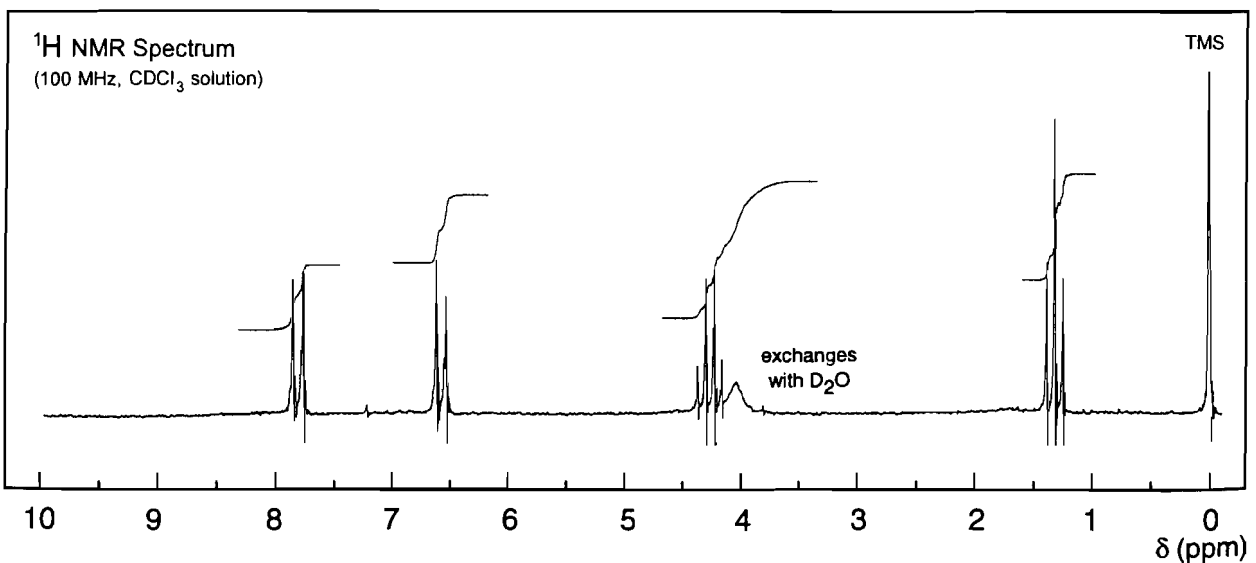
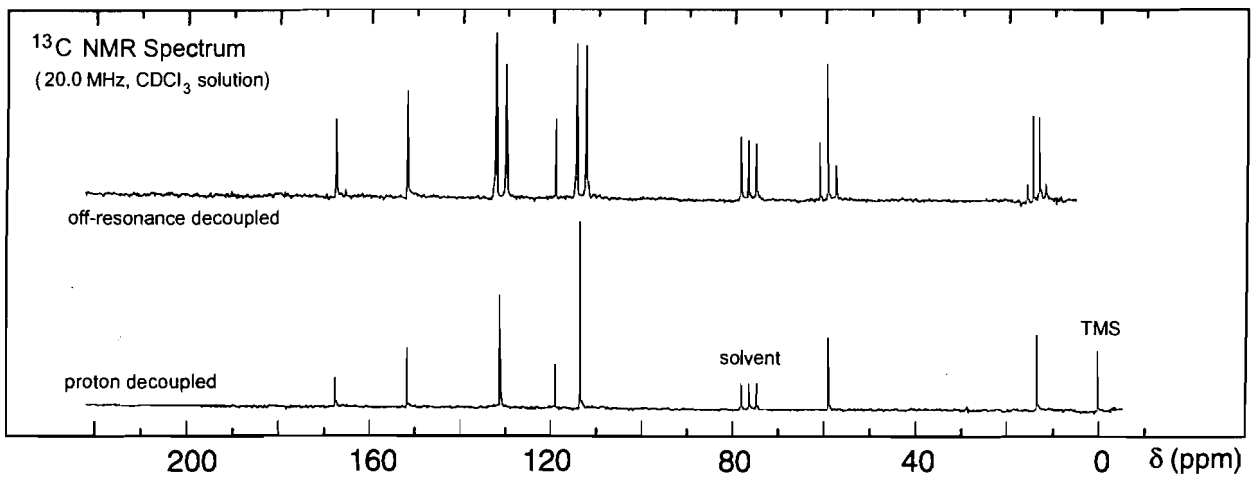
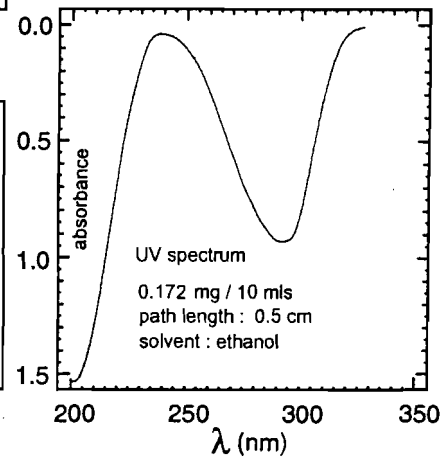
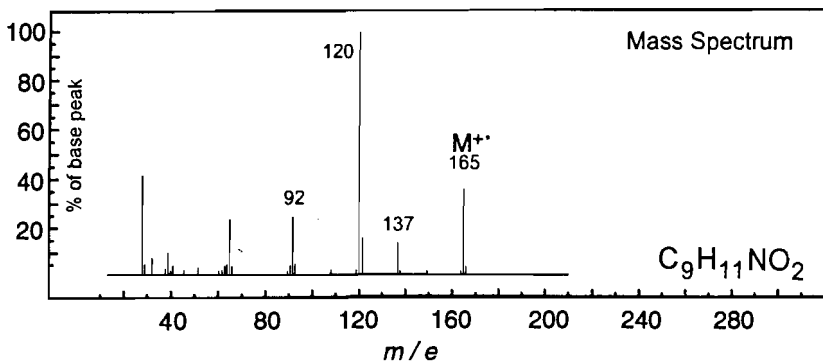
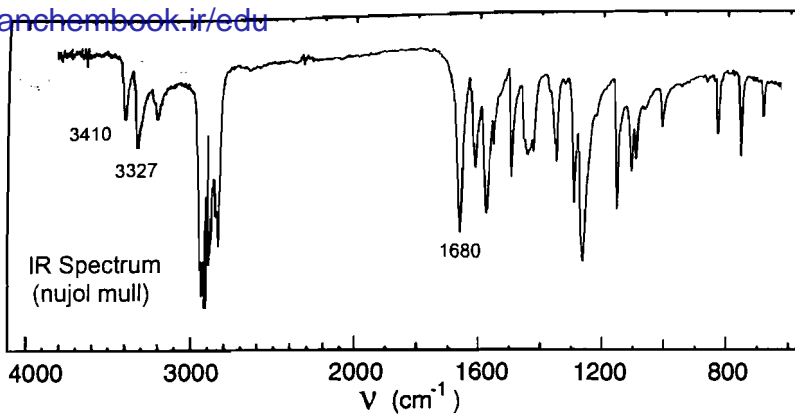

## Problem 122

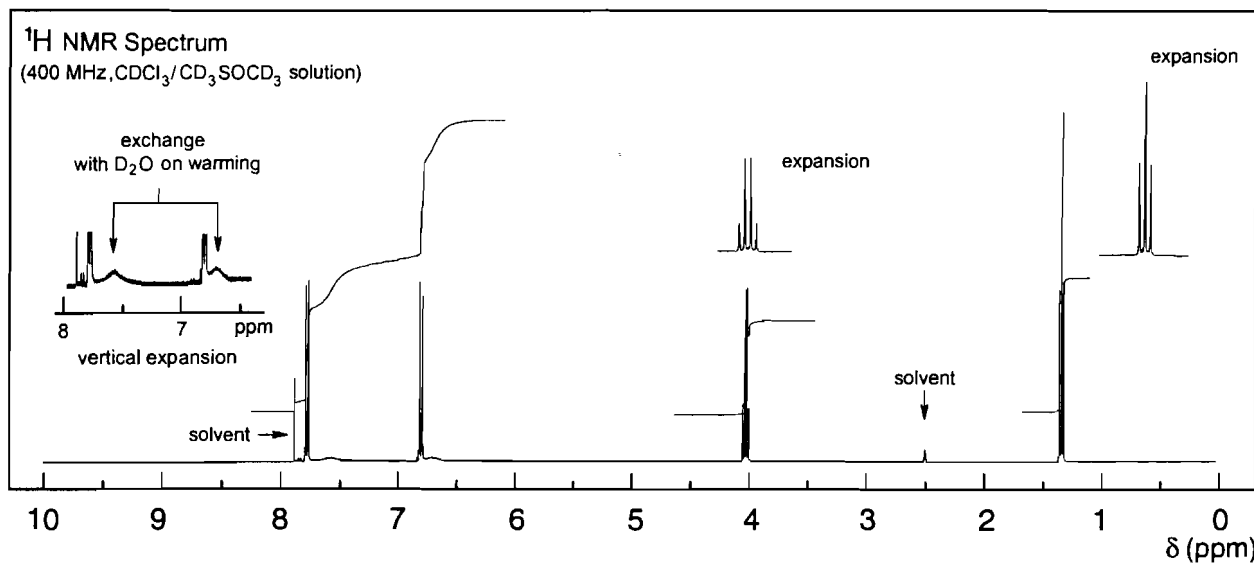
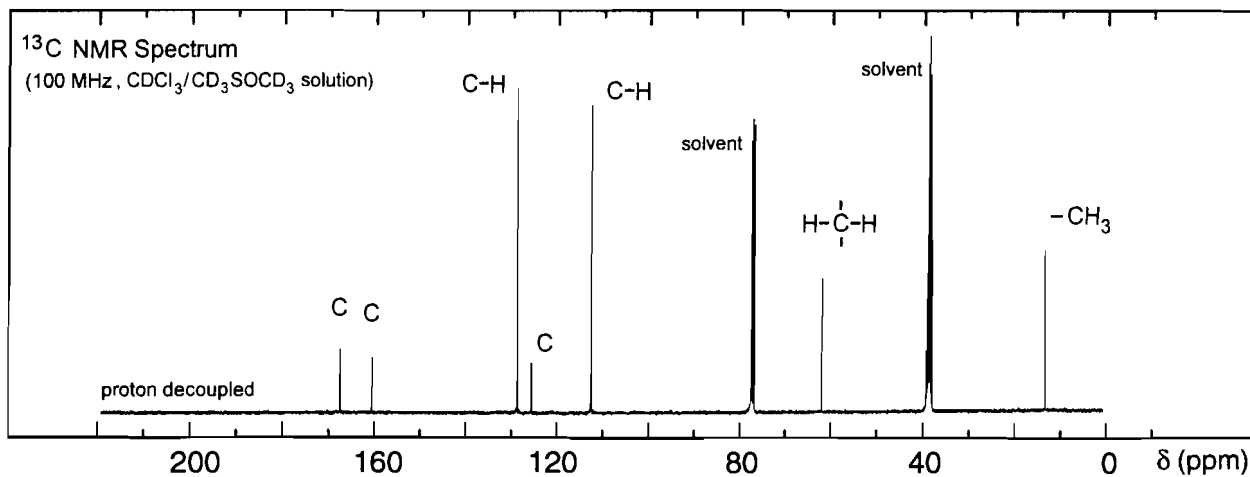
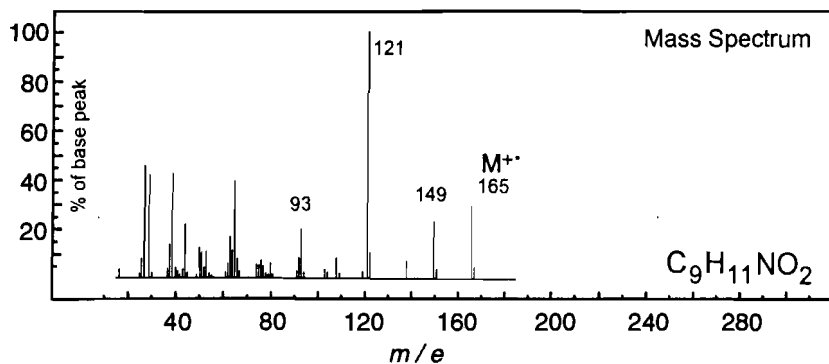
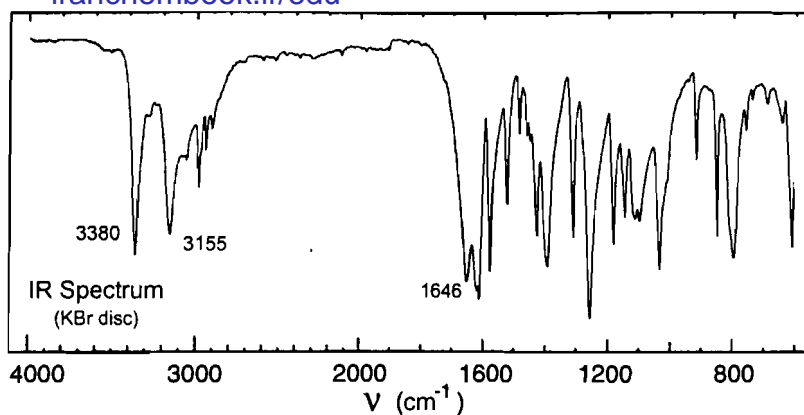

## Problem 123

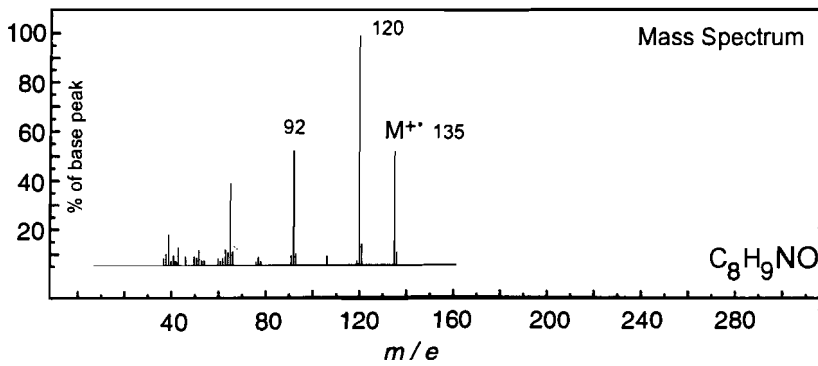
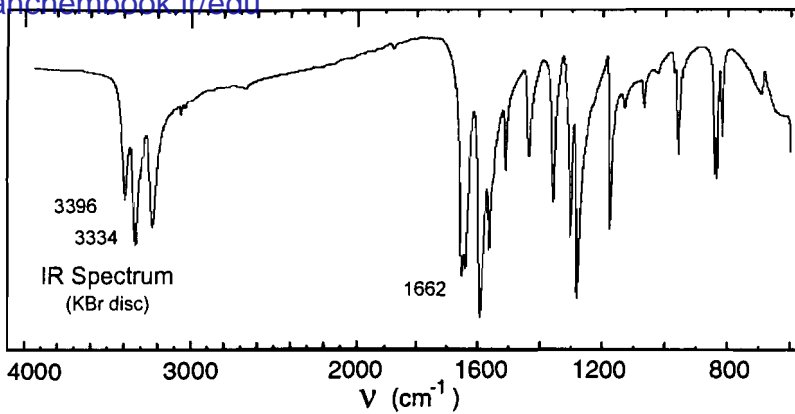

UV Spectrum

 $\lambda_{\max}$  312 nm (log<sub>10</sub>  $\epsilon$  4.3)

solvent: methanol

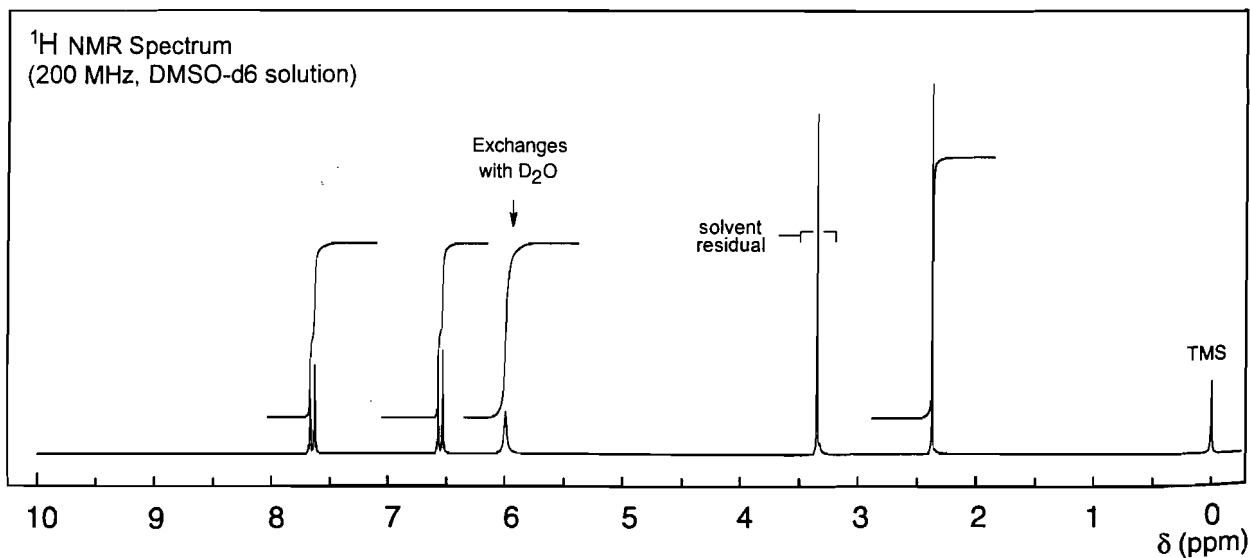
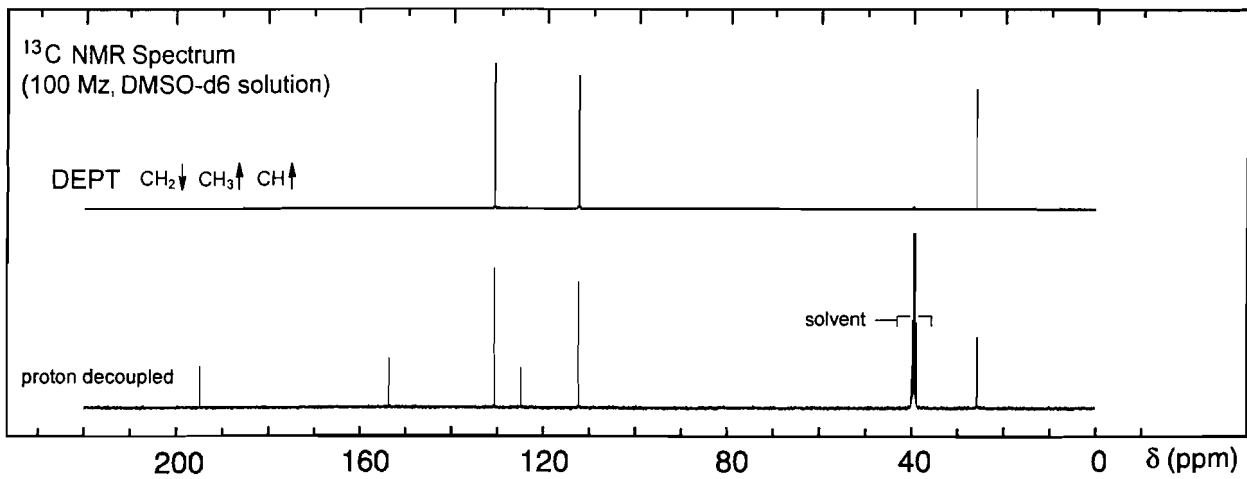

## Problem 124

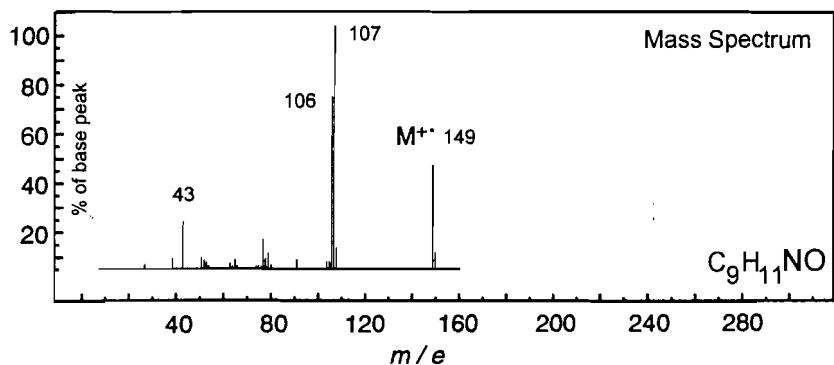
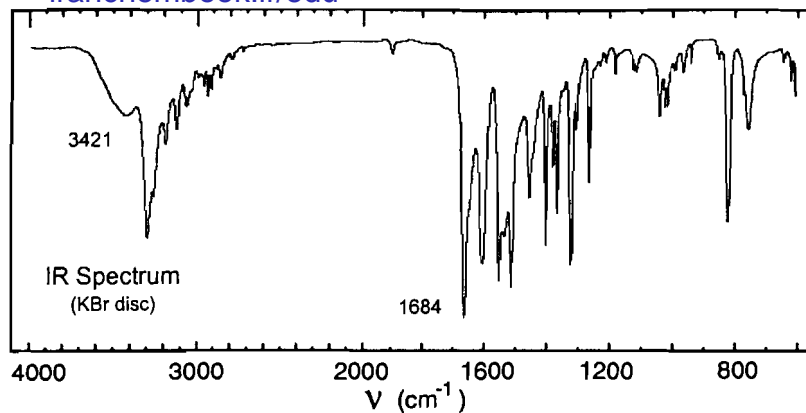

UV Spectrum

 $\lambda_{\text{max}}$  246 nm ( $\log_{10}\epsilon$  4.2) $\lambda_{\text{max}}$  280 nm ( $\log_{10}\epsilon$  3.1)

solvent: methanol

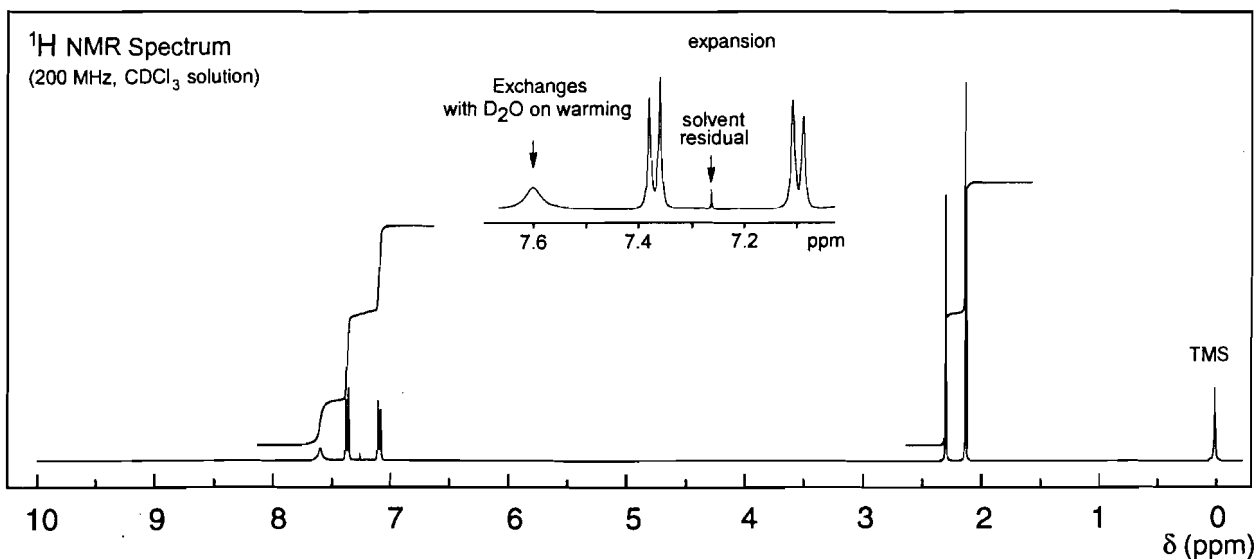
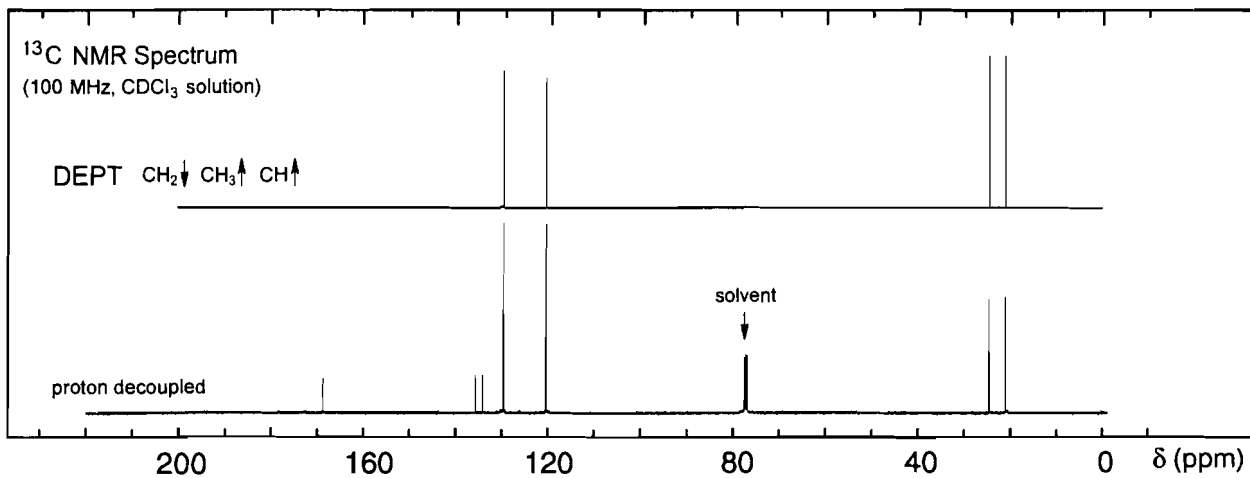

## Problem 125

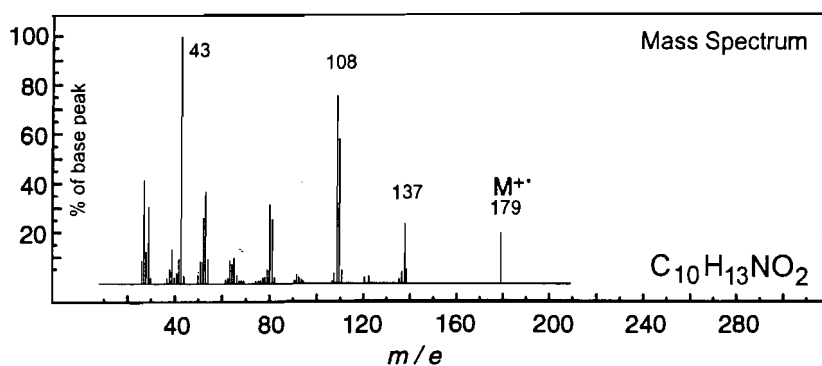
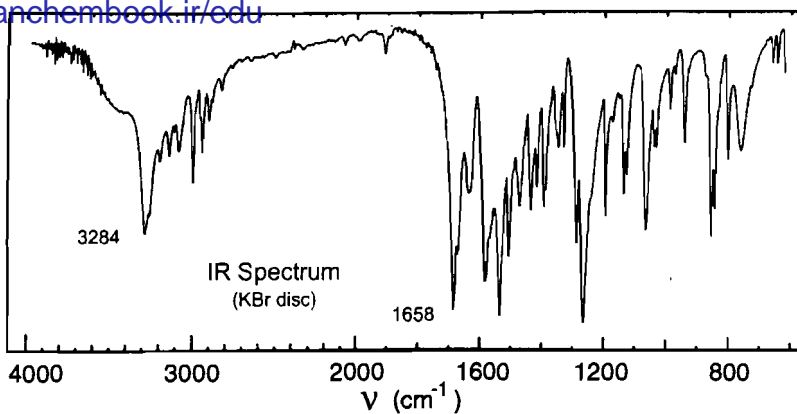

UV Spectrum

 $\lambda_{\text{max}}$  250 nm ( $\log_{10} \epsilon$  3.1) $\lambda_{\text{max}}$  287 nm ( $\log_{10} \epsilon$  2.2)

solvent: chloroform

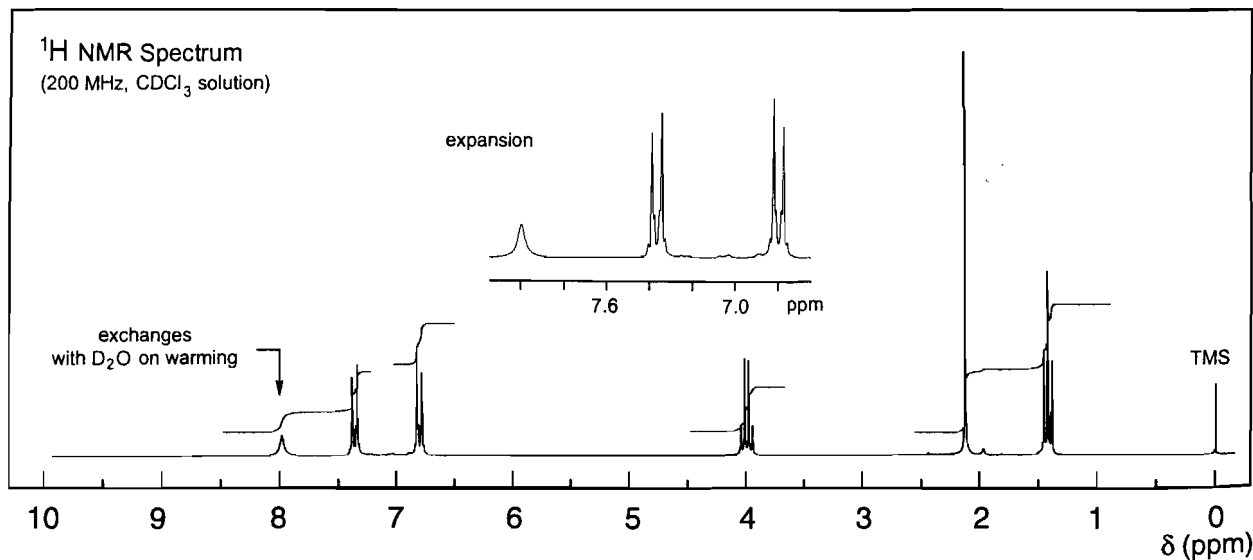
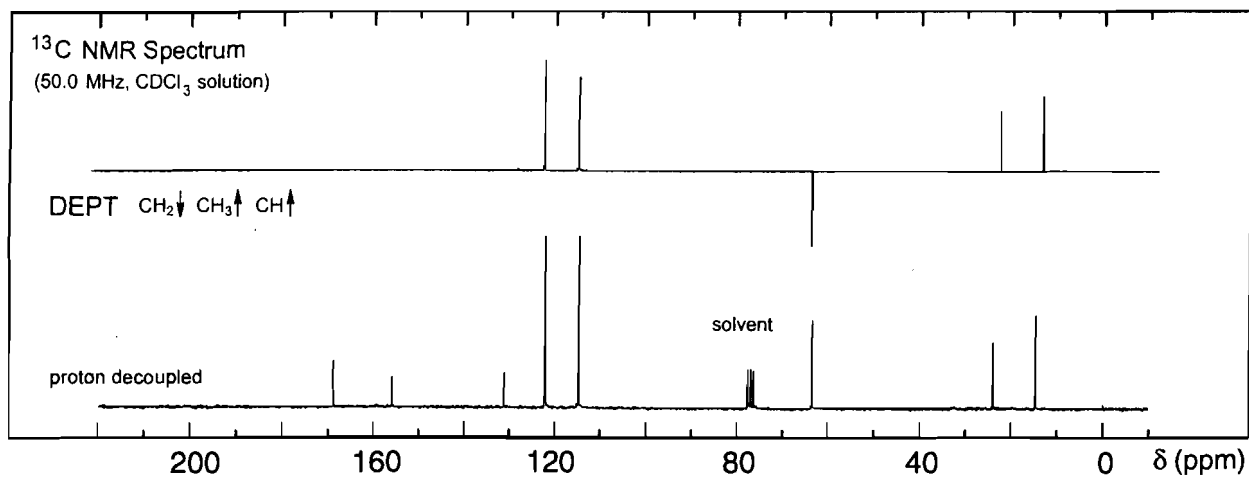

## Problem 126

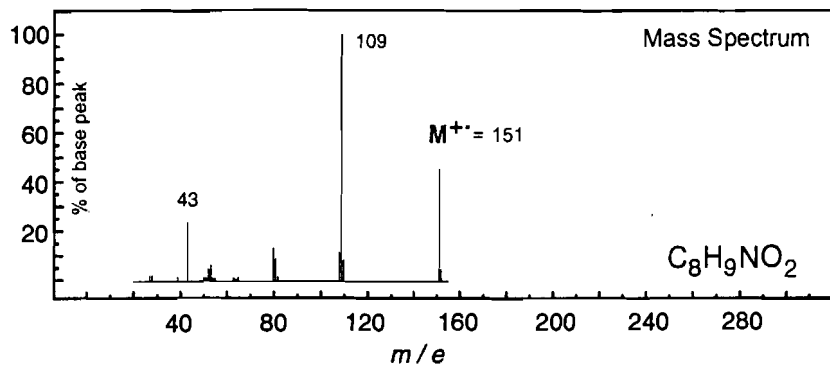
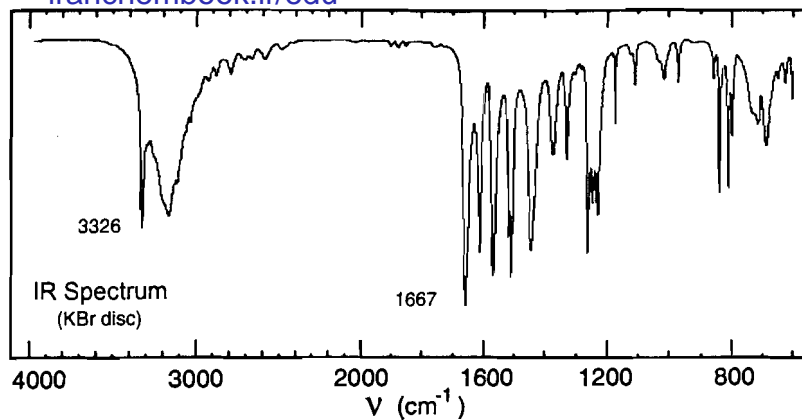

UV Spectrum

 $\lambda_{\text{max}}$  250 nm ( $\log_{10}\epsilon$  4.1) $\lambda_{\text{max}}$  285 nm ( $\log_{10}\epsilon$  3.6)

solvent: ethanol

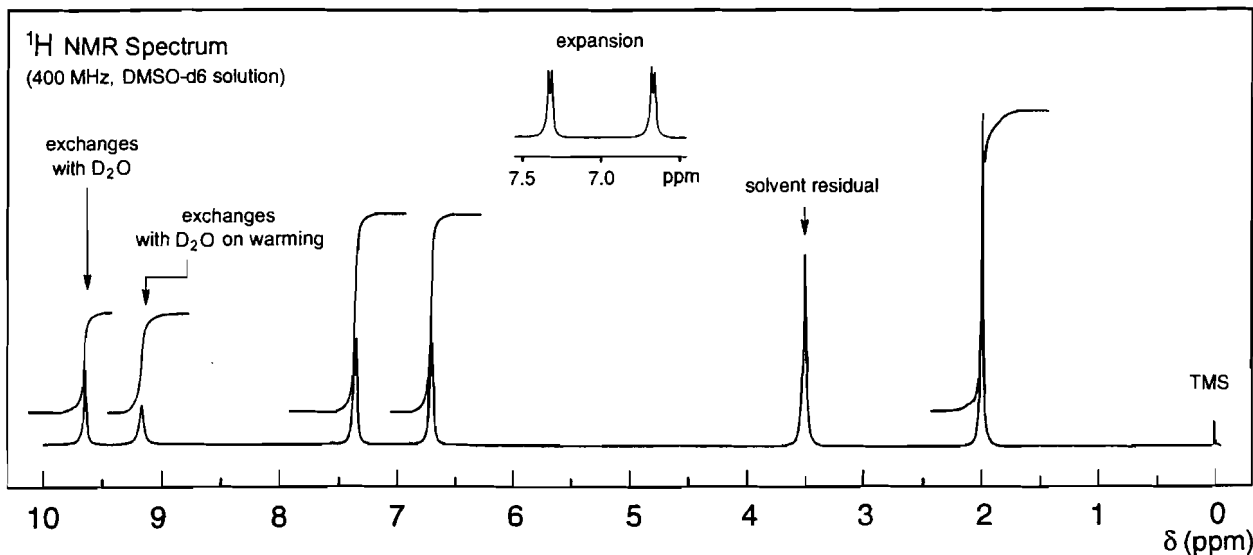
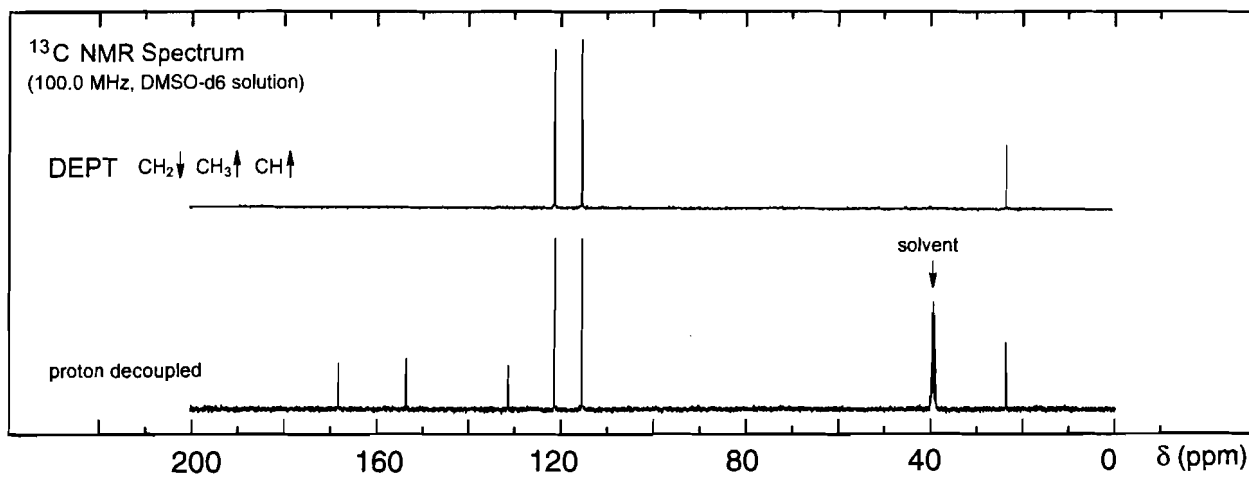



## Problem 127

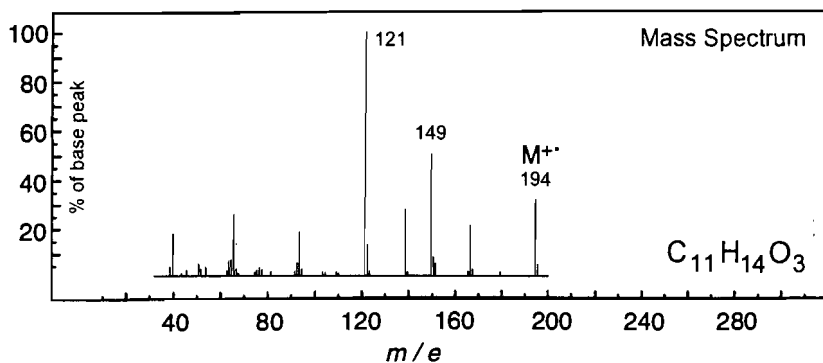
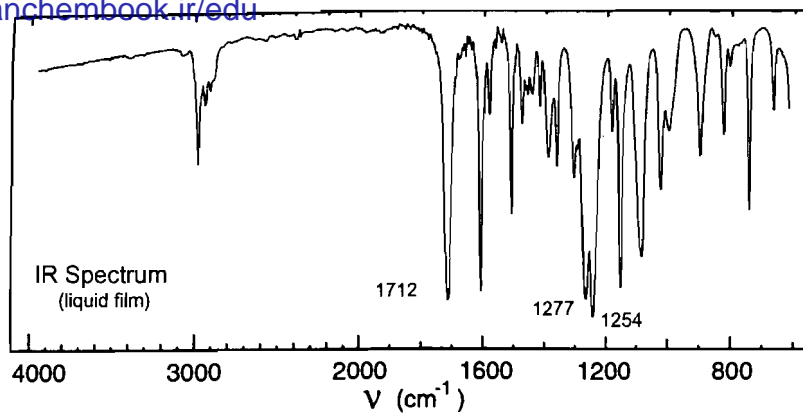

UV Spectrum

 $\lambda_{\max}$  257 nm ( $\log_{10}\epsilon$  4.3)

solvent : methanol

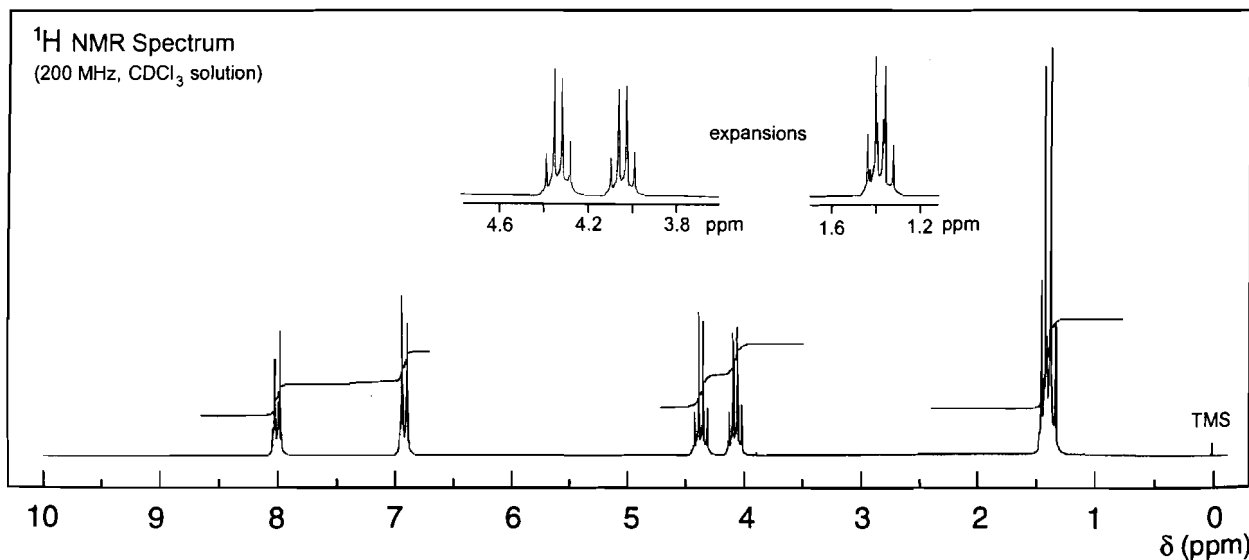
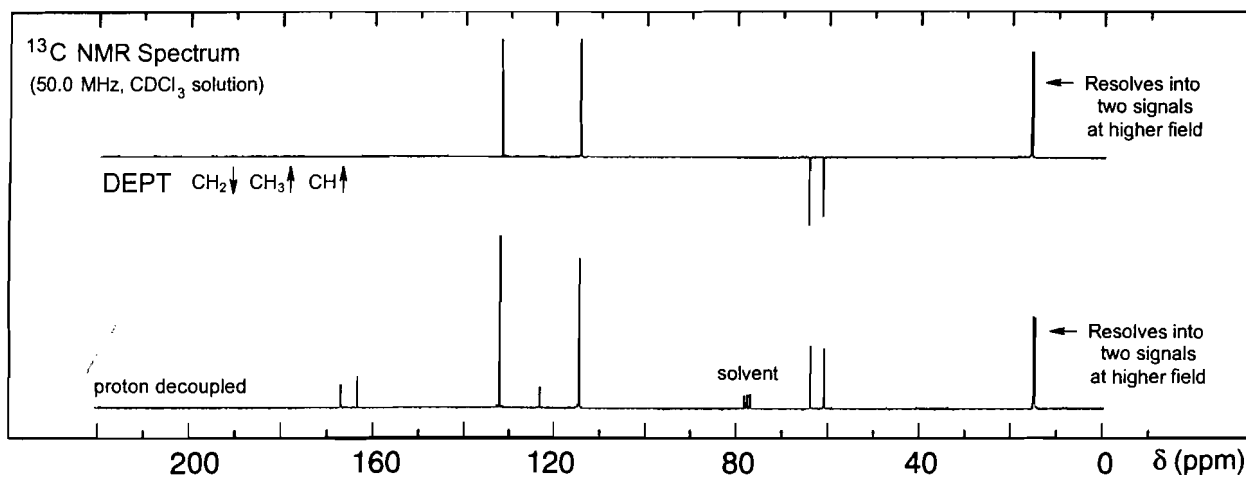

## Problem 128

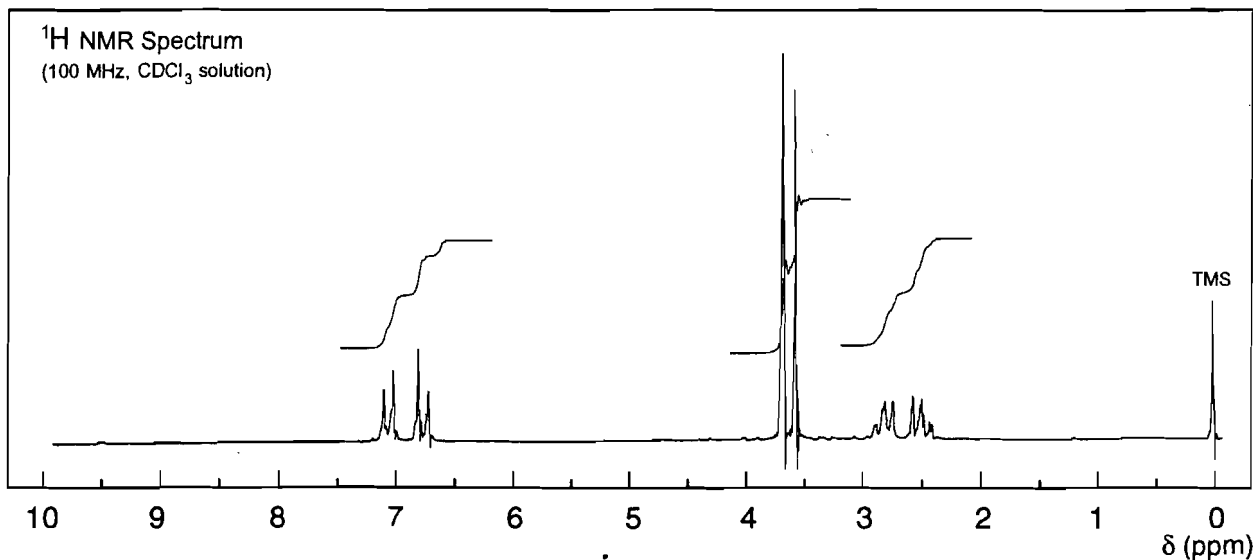
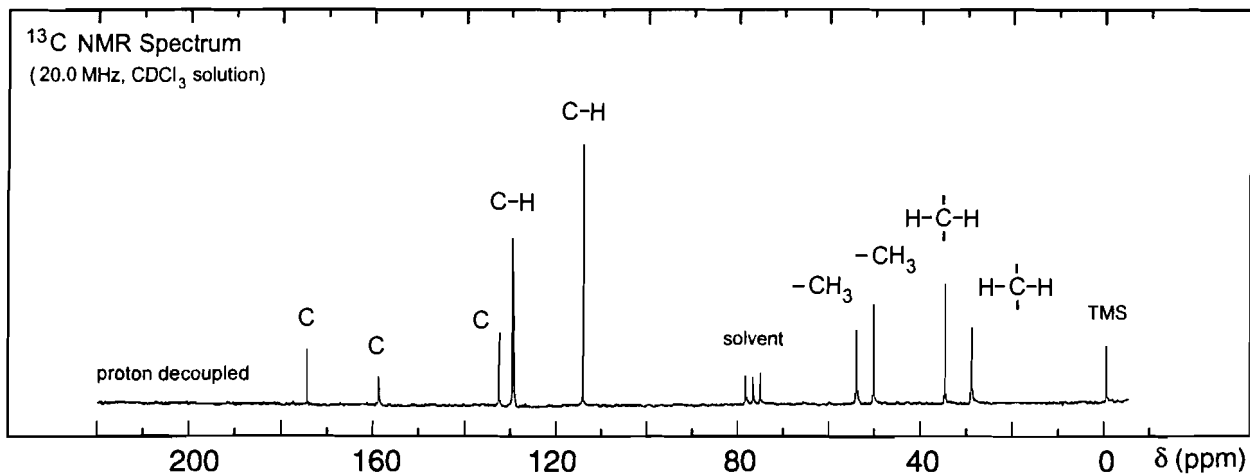
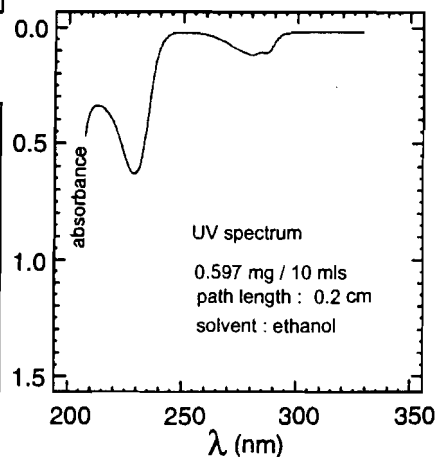
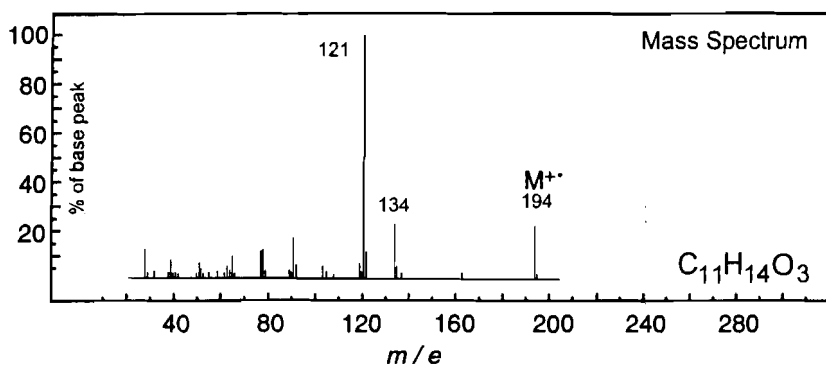
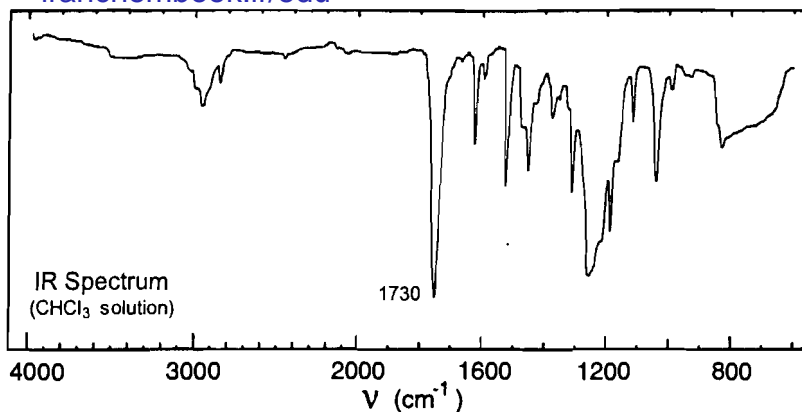

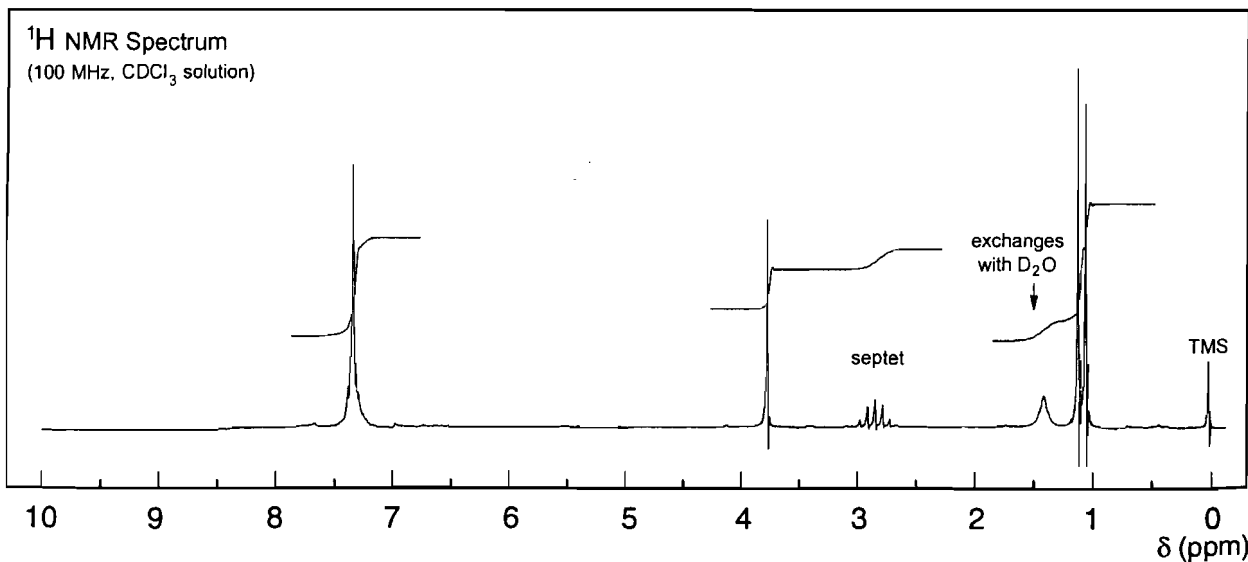
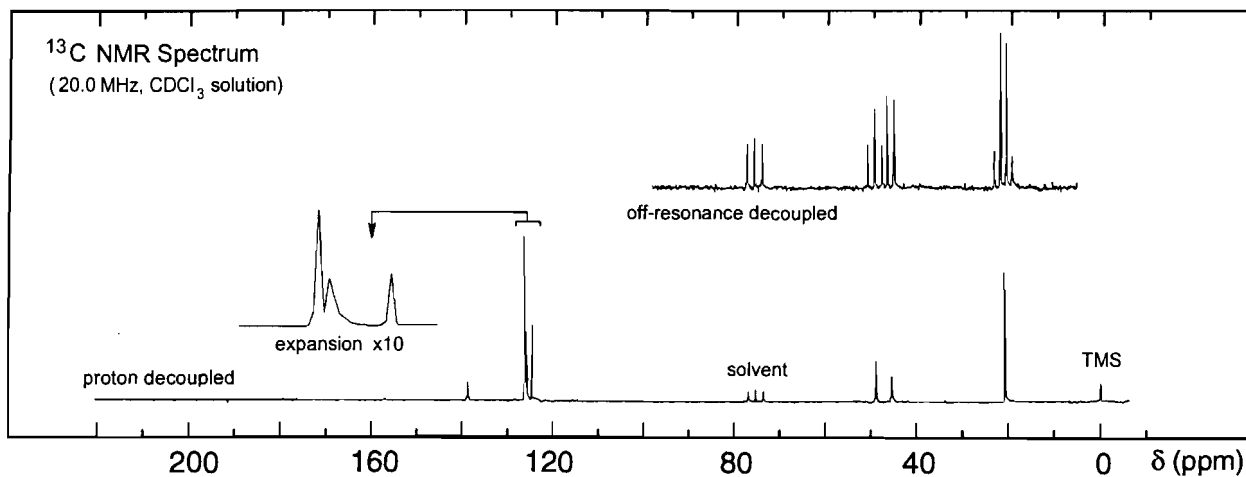
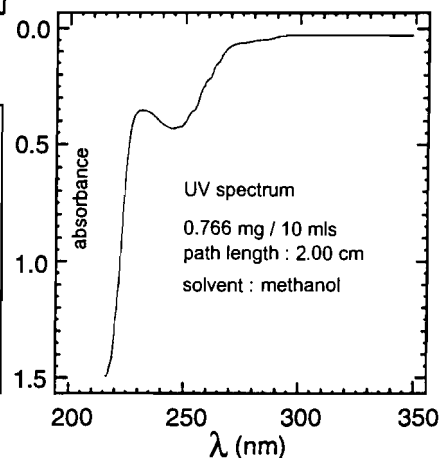
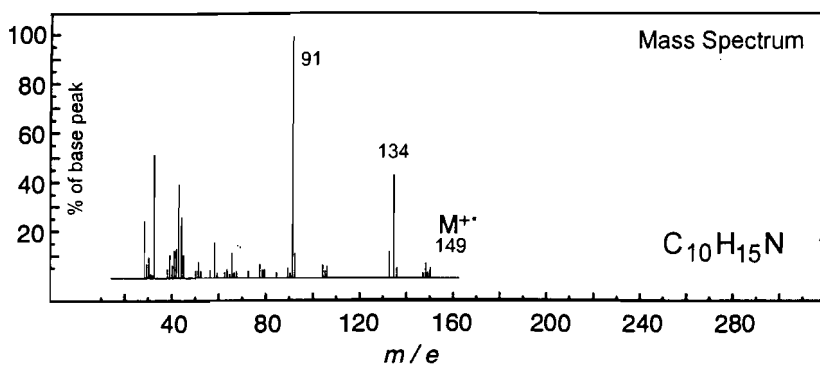
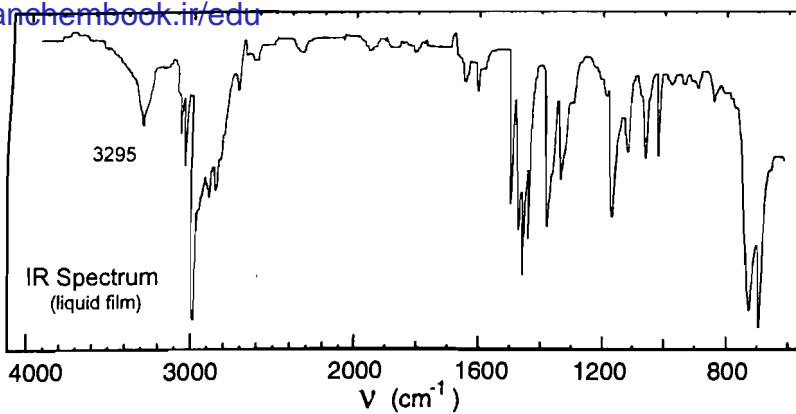

## Problem 130

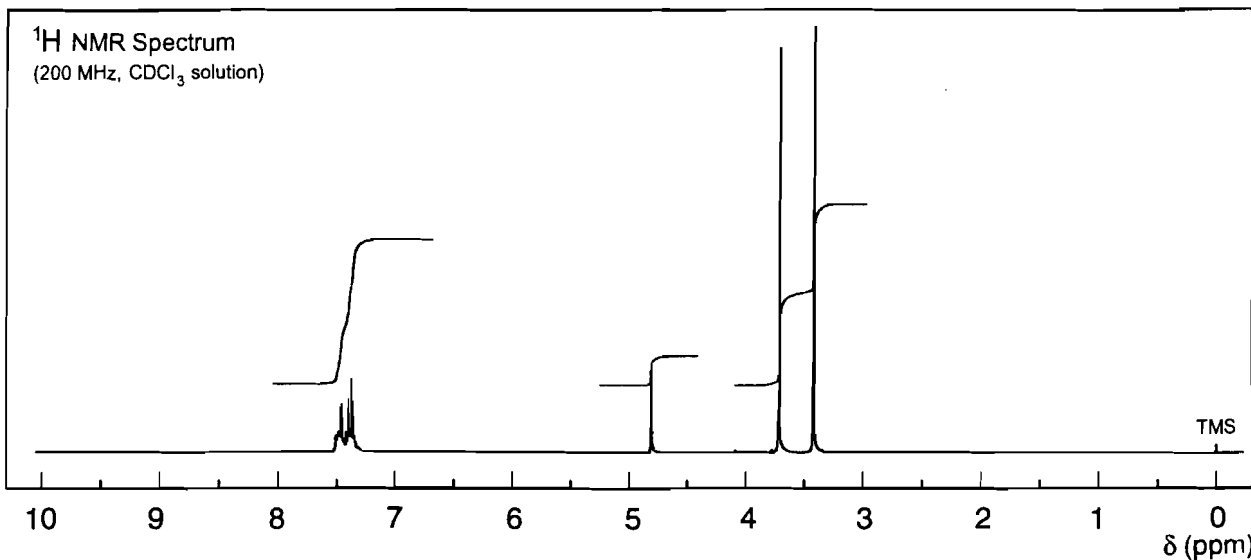
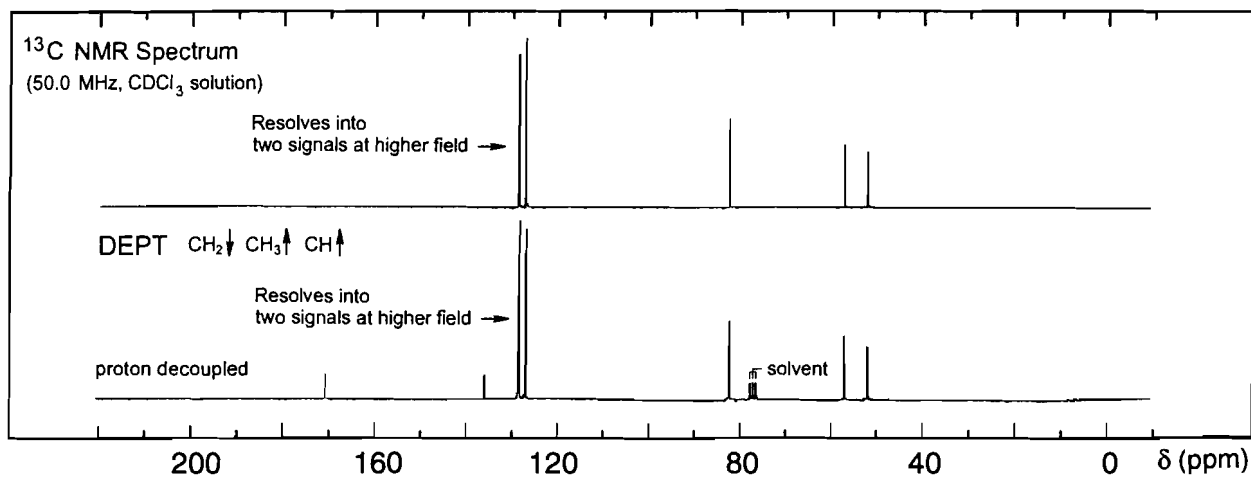
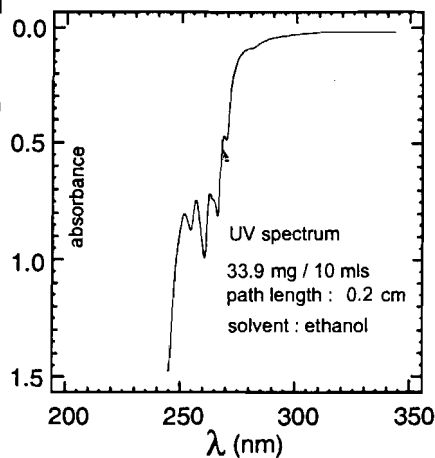
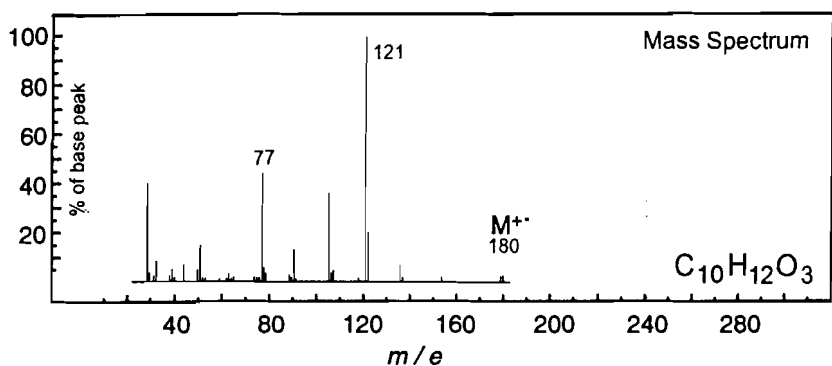
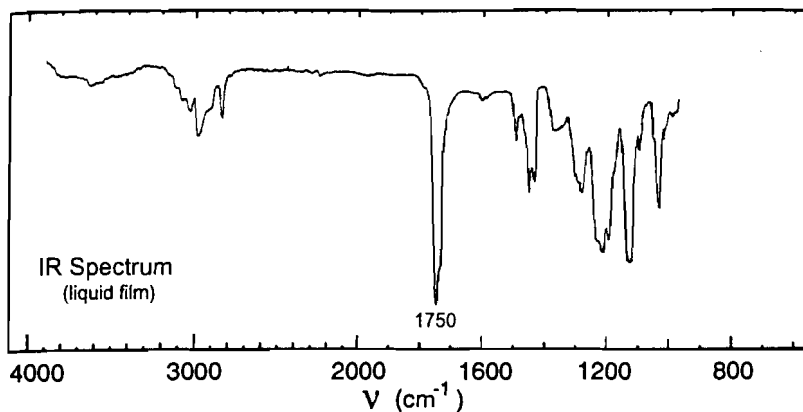

# Problem 131

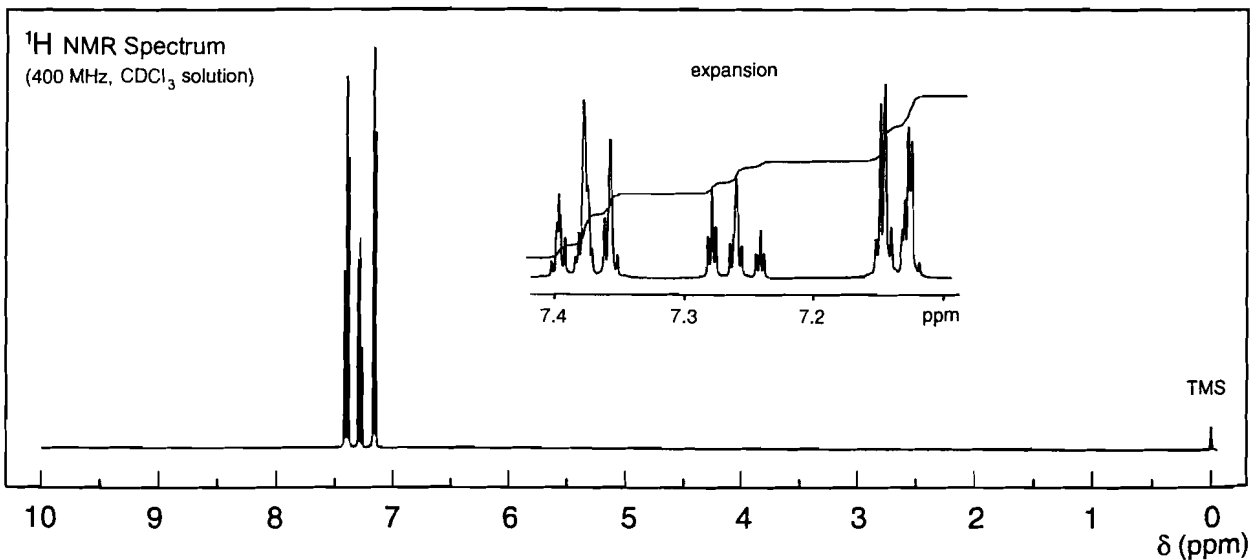
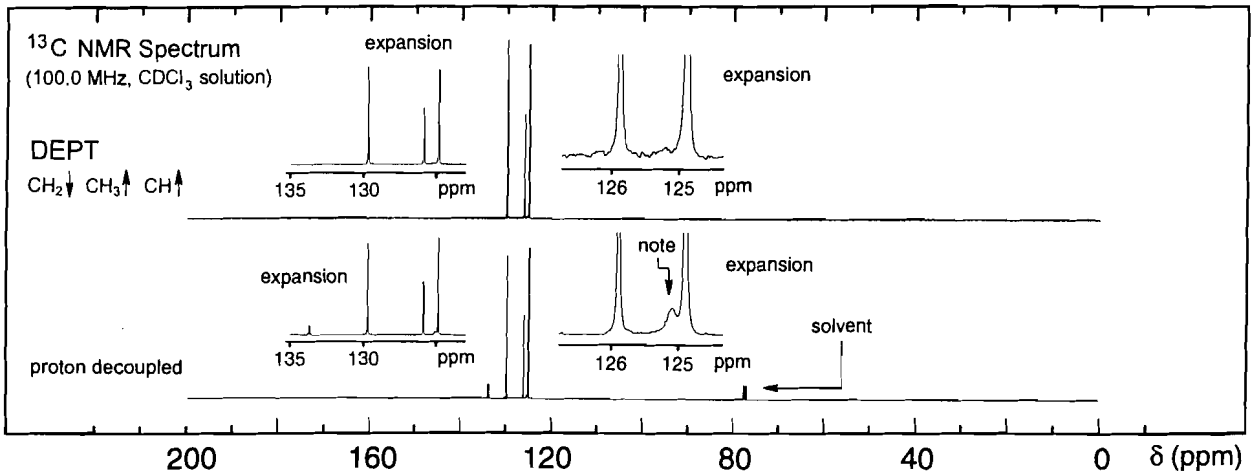
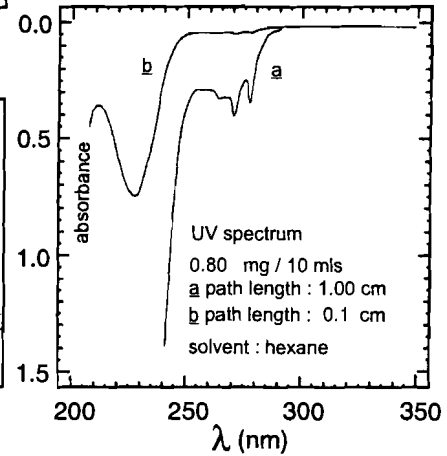
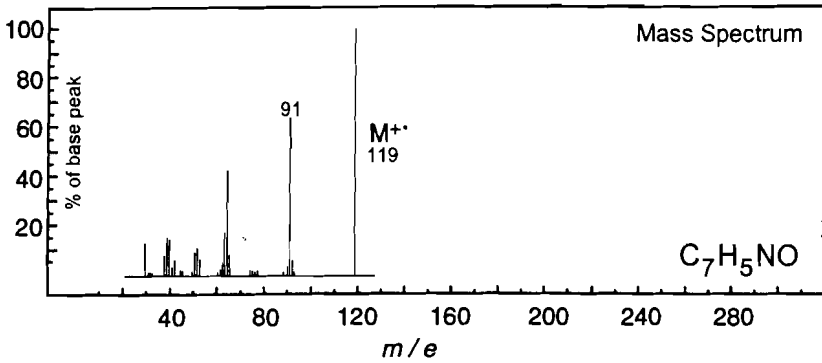
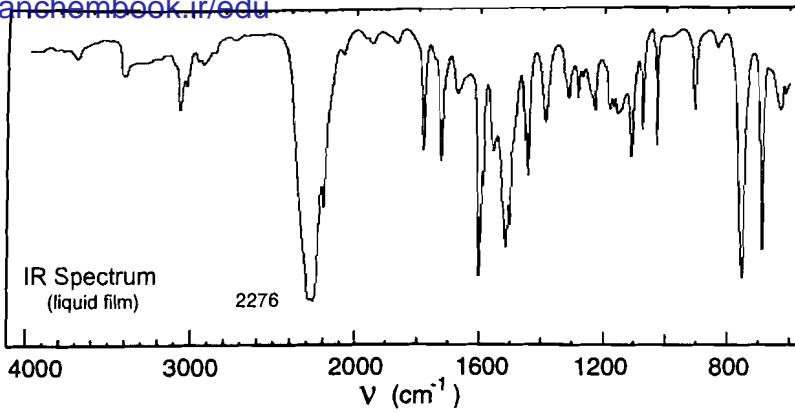

## Problem 132

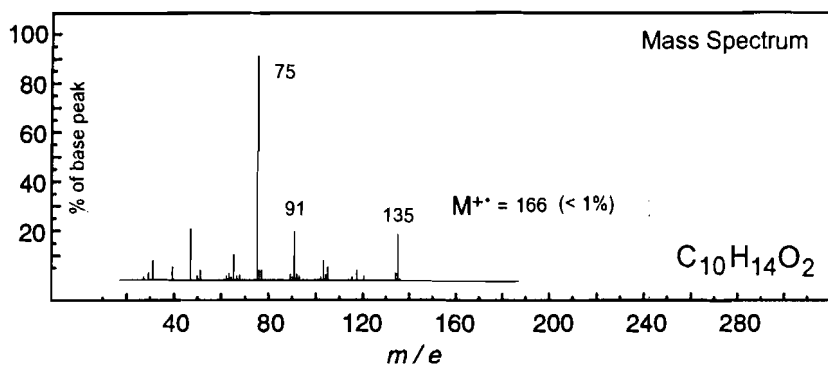
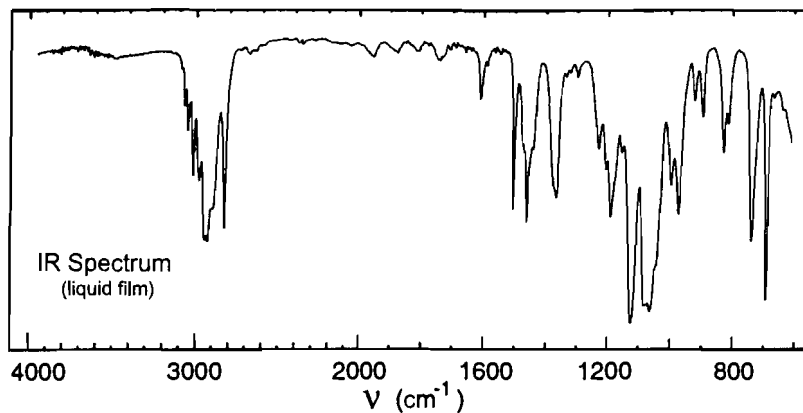

UV Spectrum

$$\lambda_{\max} 262 \text{ nm } (\log_{10} \epsilon 2.3)$$

solvent : methanol

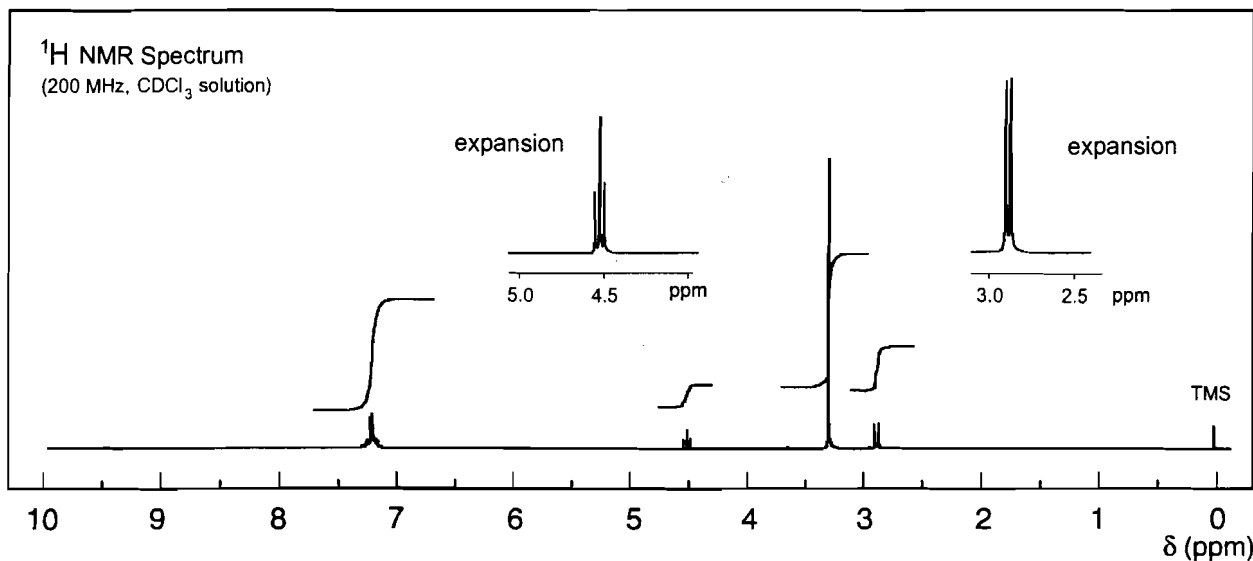
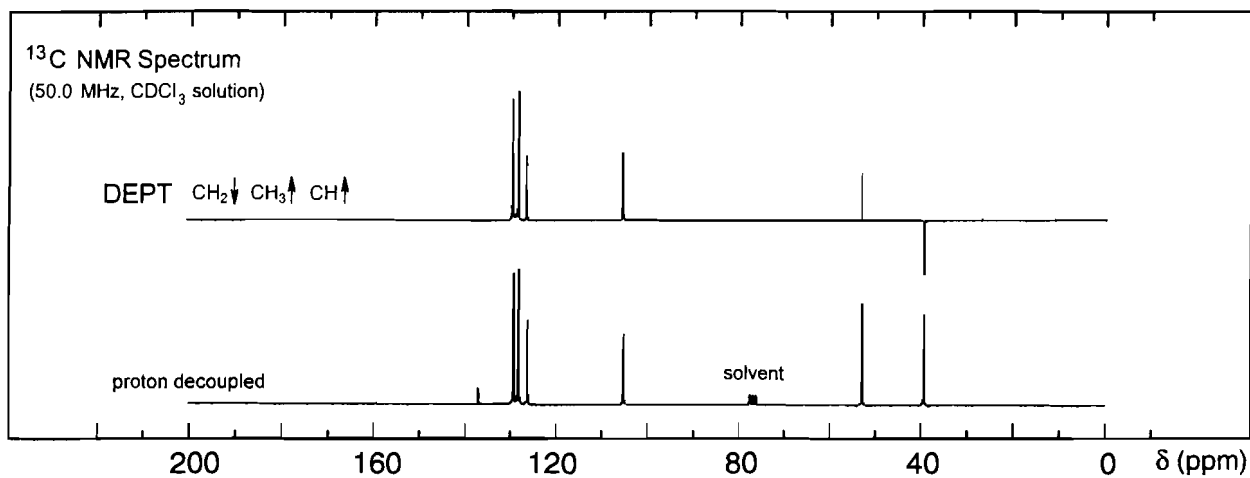

## Problem 133

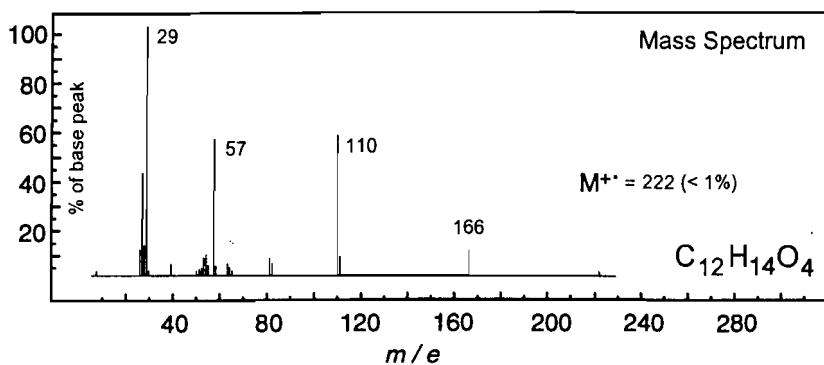
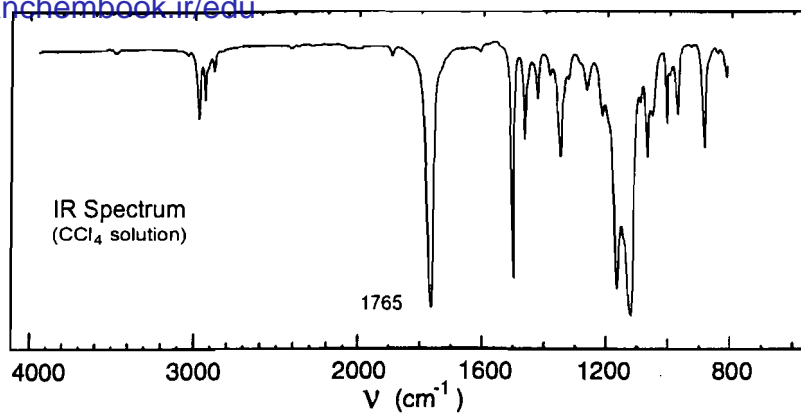

UV Spectrum

 $\lambda_{\text{max}}$  269 nm ( $\log_{10}\epsilon$  2.7) $\lambda_{\text{max}}$  263 nm ( $\log_{10}\epsilon$  2.7)

solvent : methanol

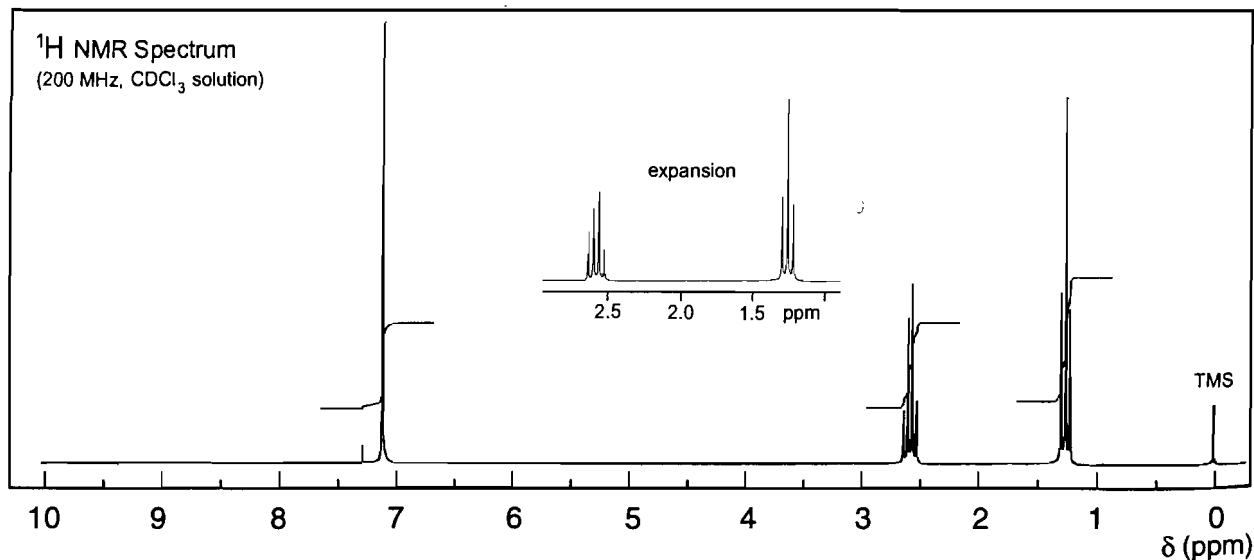
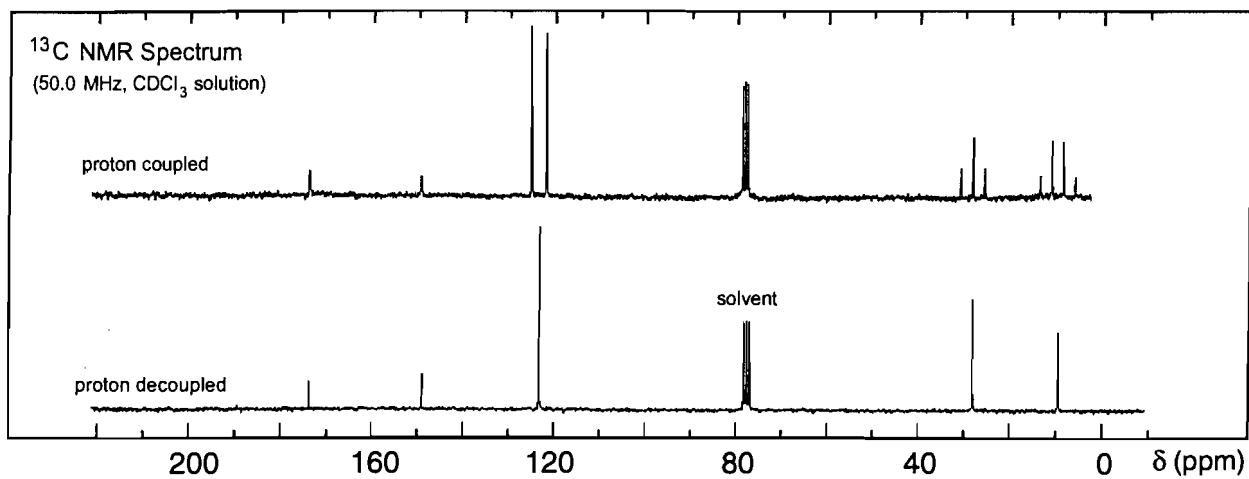

## Problem 134

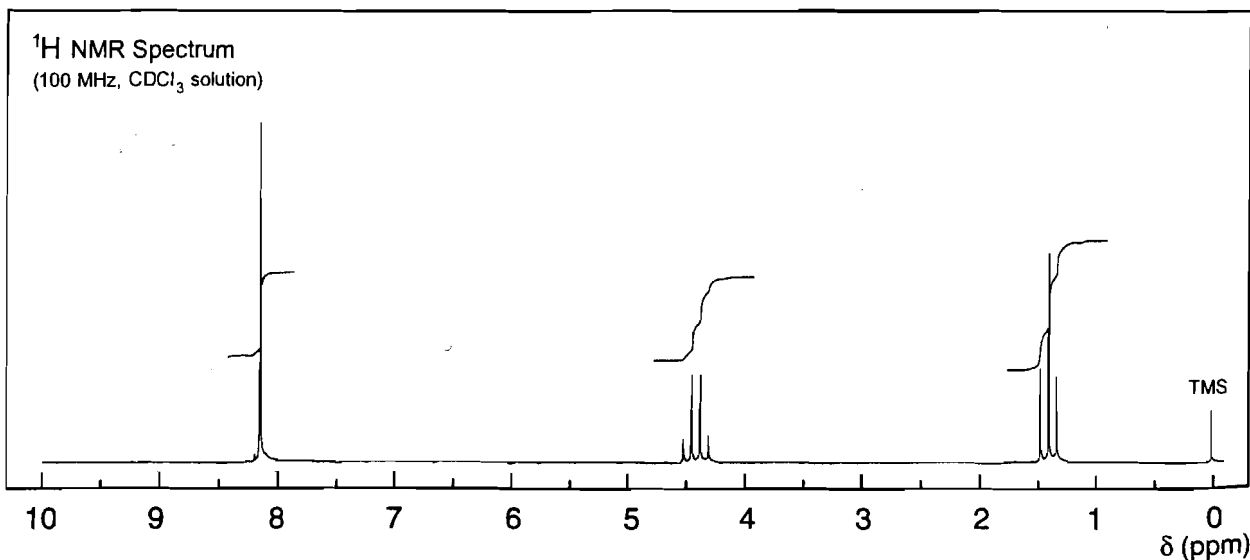
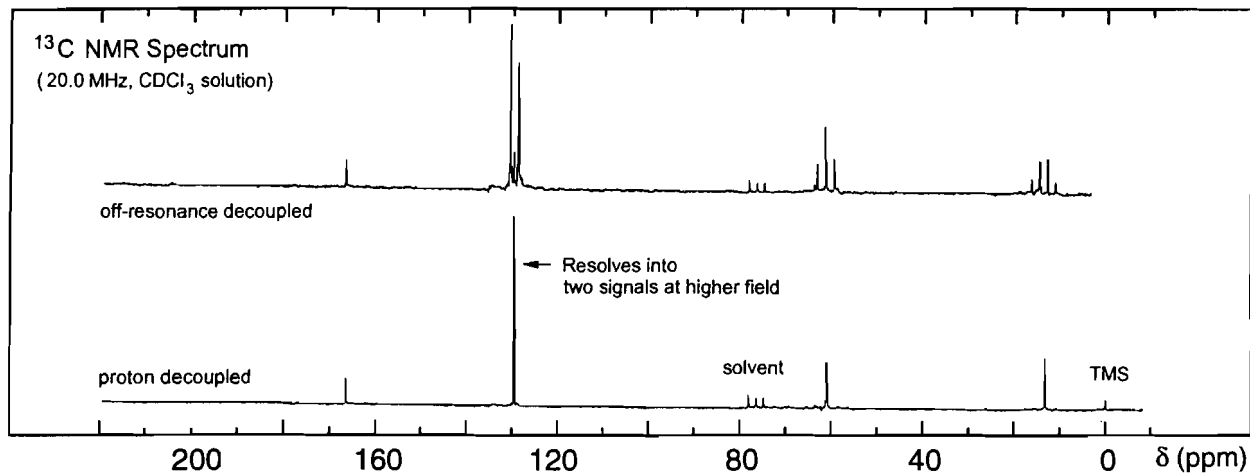
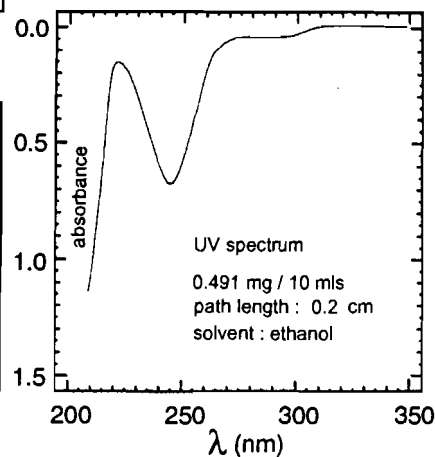
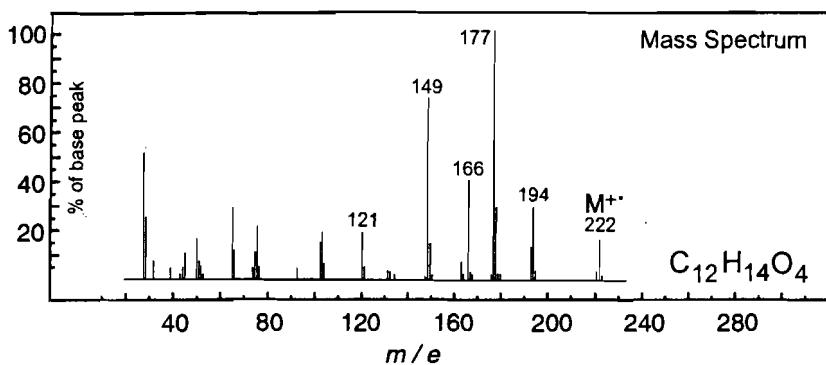
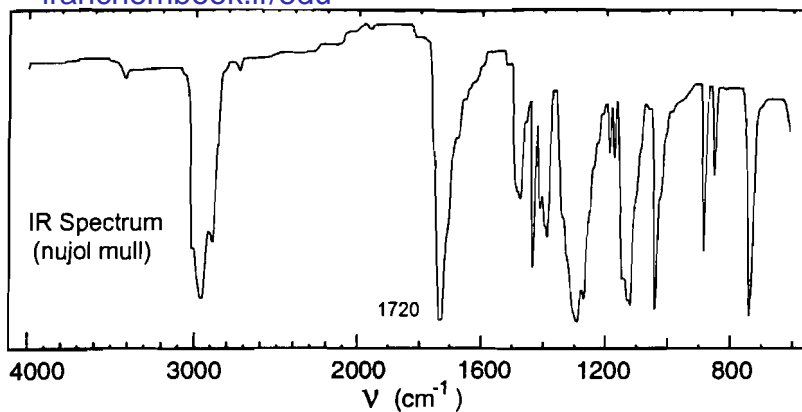



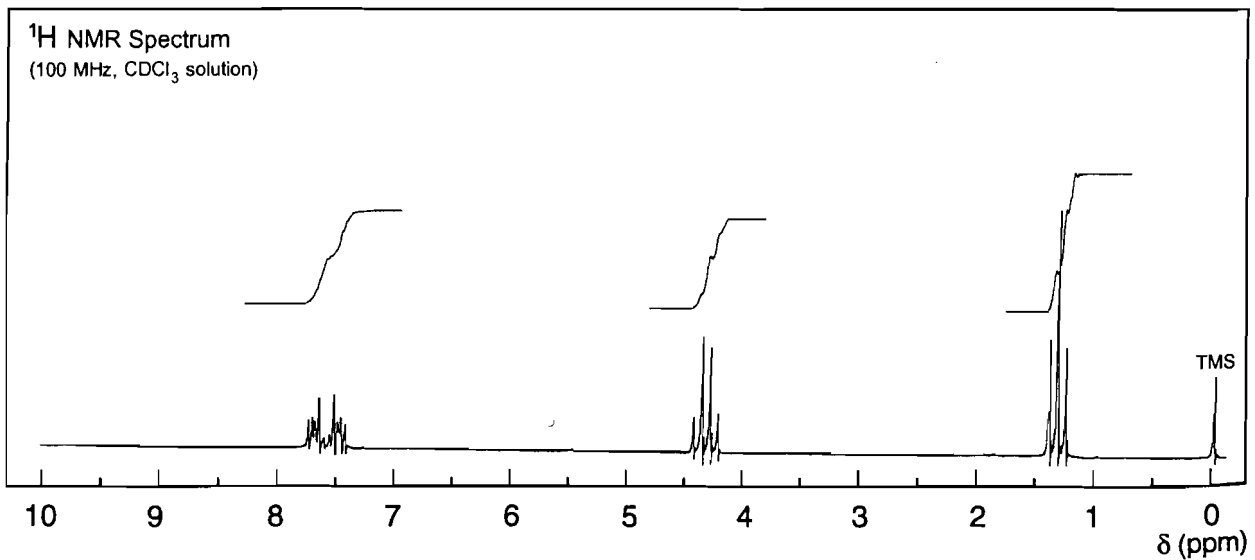
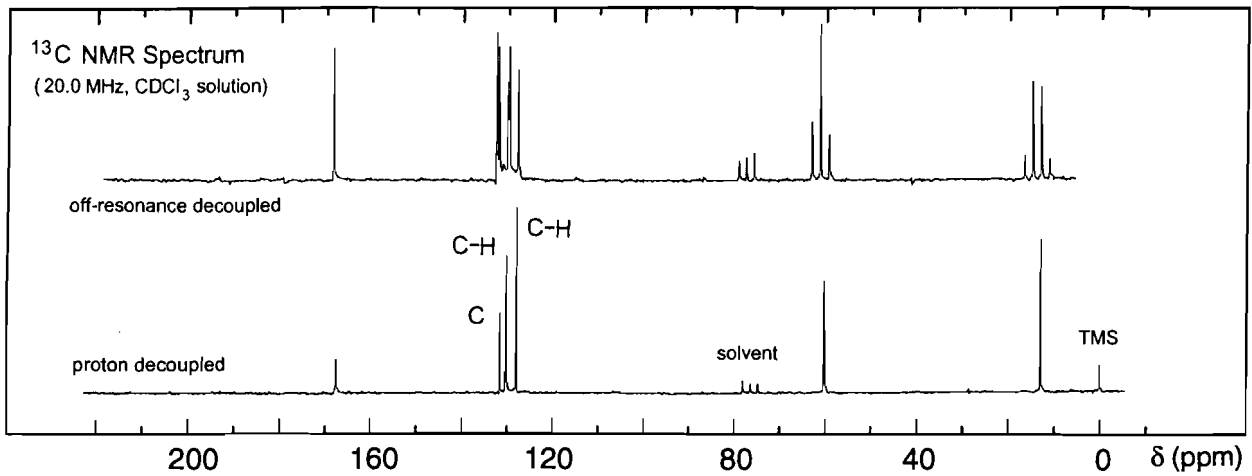
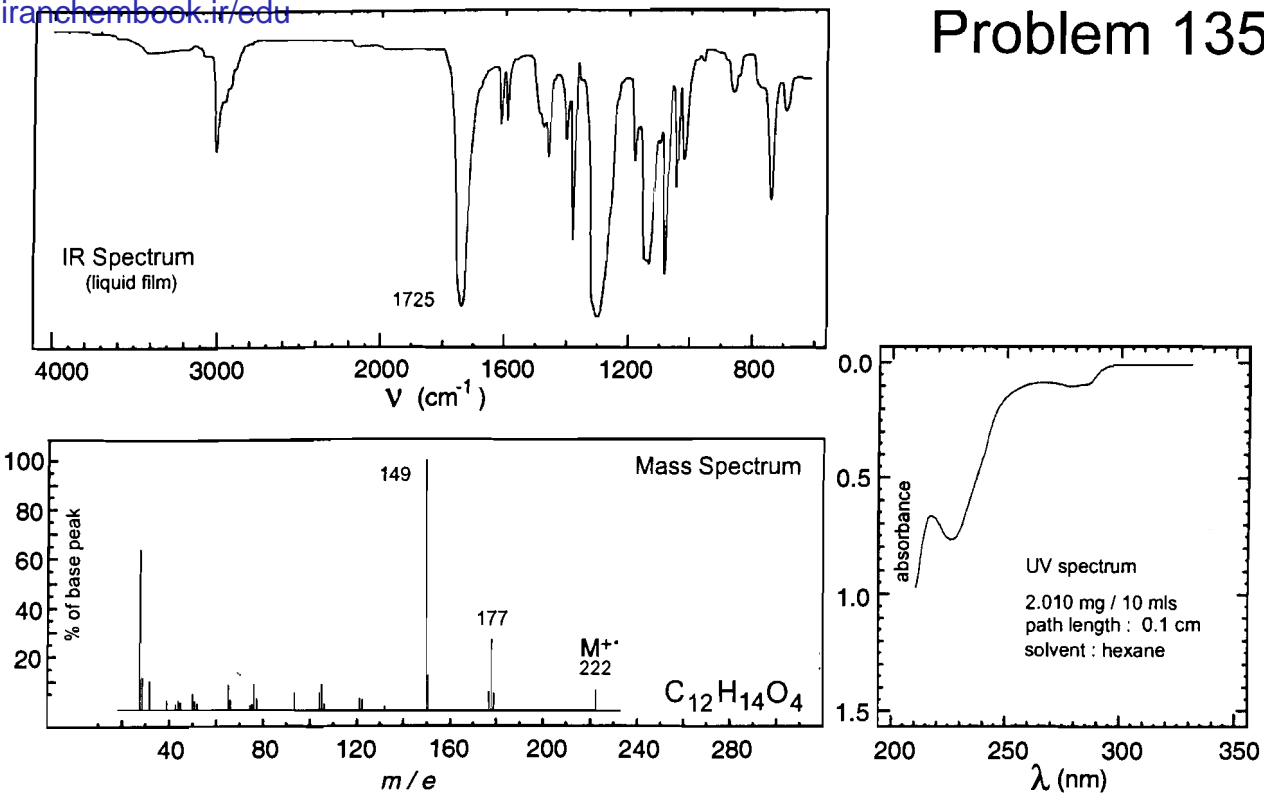

## Problem 136

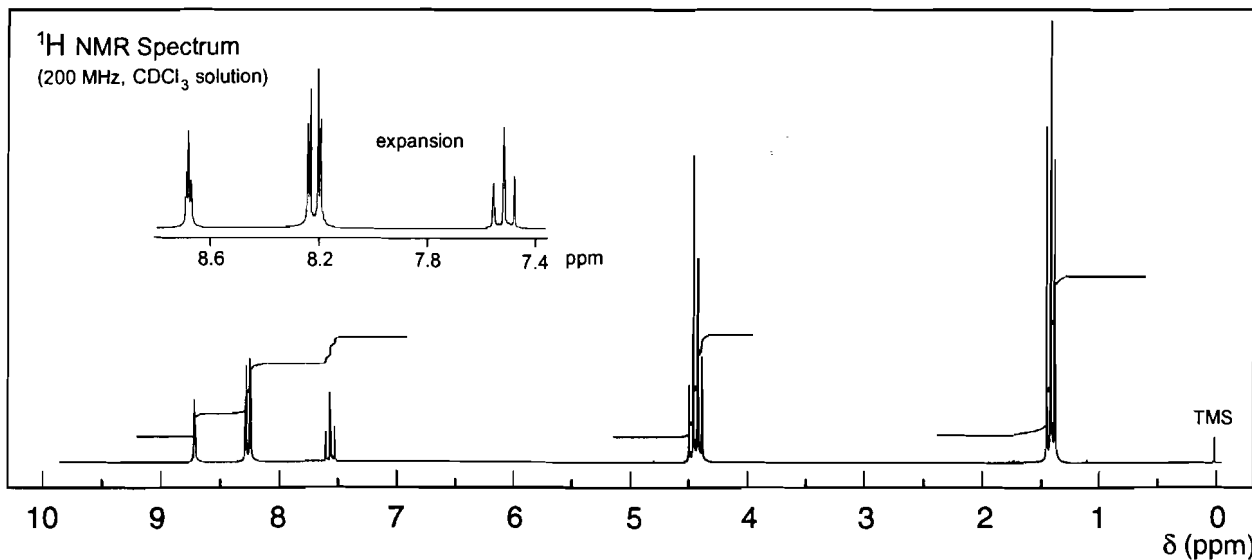
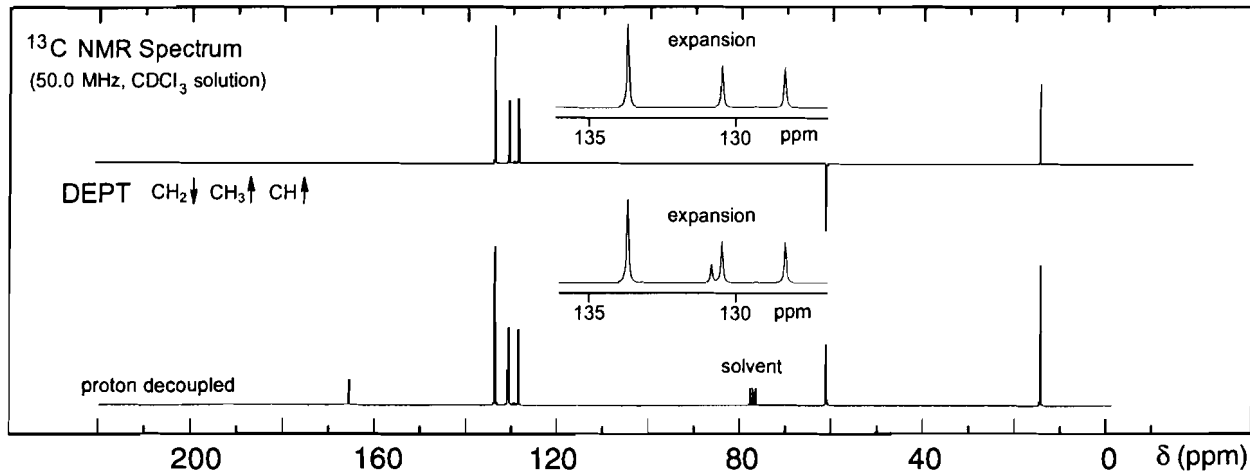
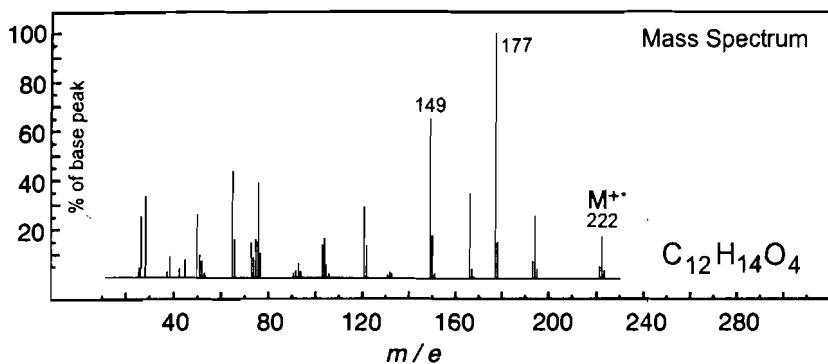
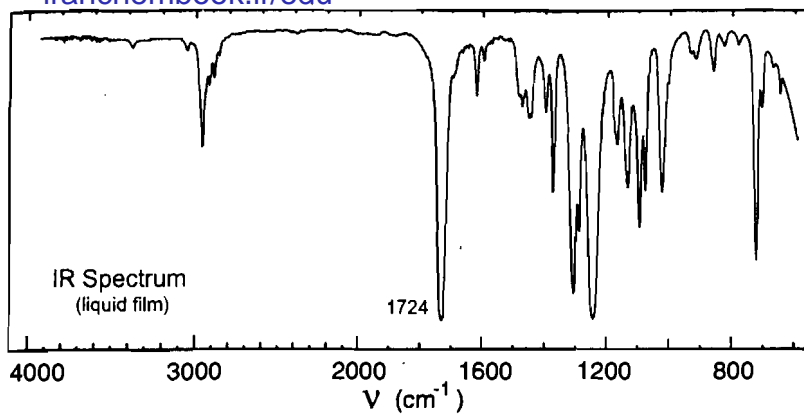

## Problem 137

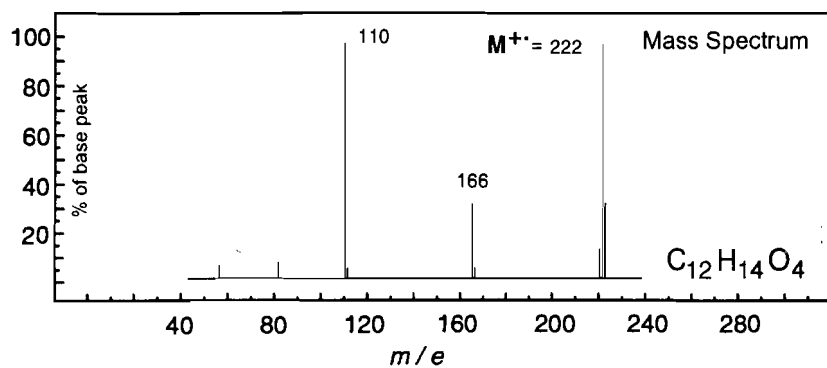
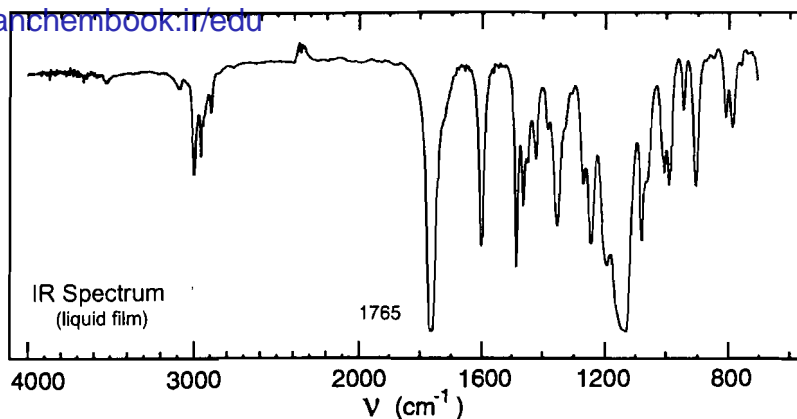

UV Spectrum

 $\lambda_{\text{max}}$  220 nm ( $\log_{10} \epsilon$  3.7) $\lambda_{\text{max}}$  274 nm ( $\log_{10} \epsilon$  3.3)

solvent: ethanol

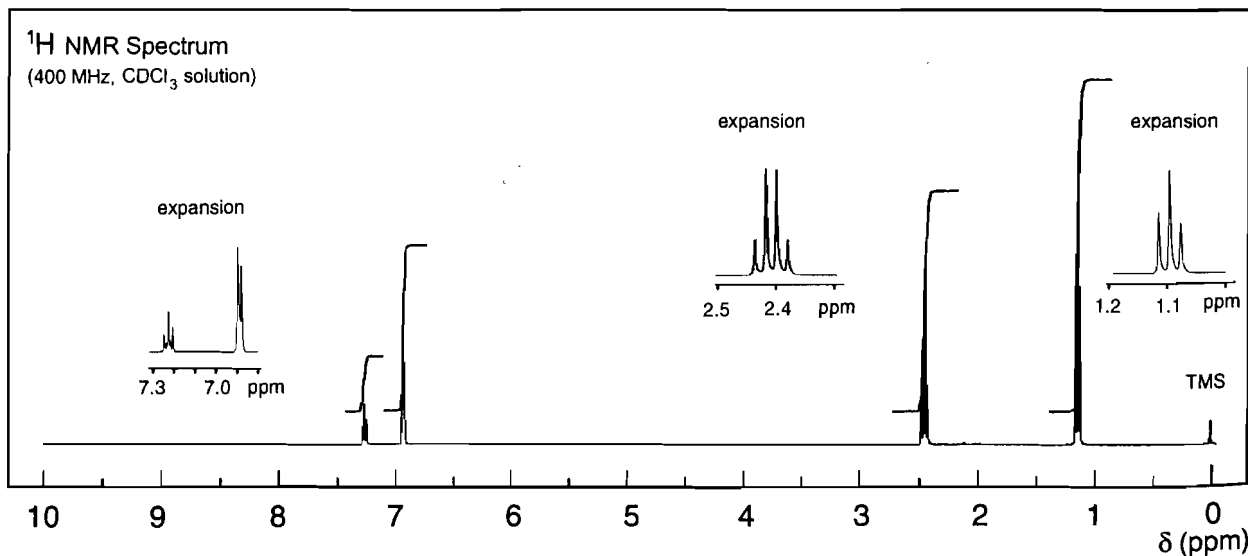
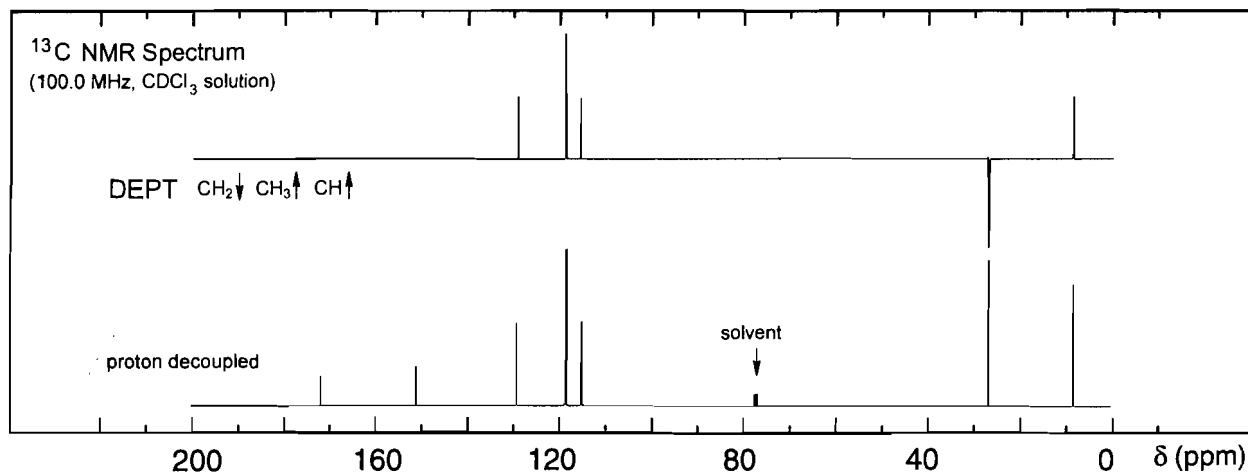

# Problem 138

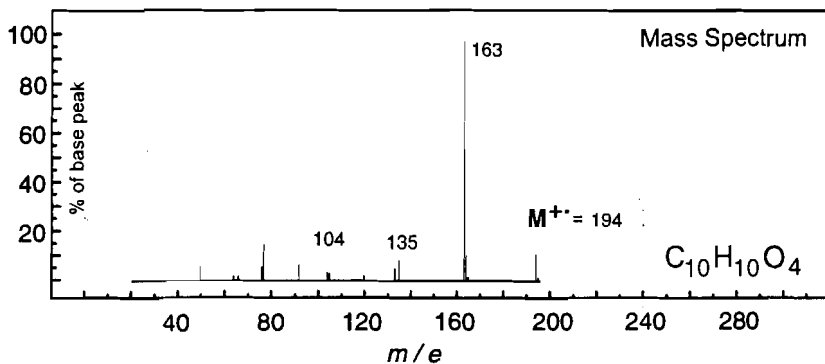
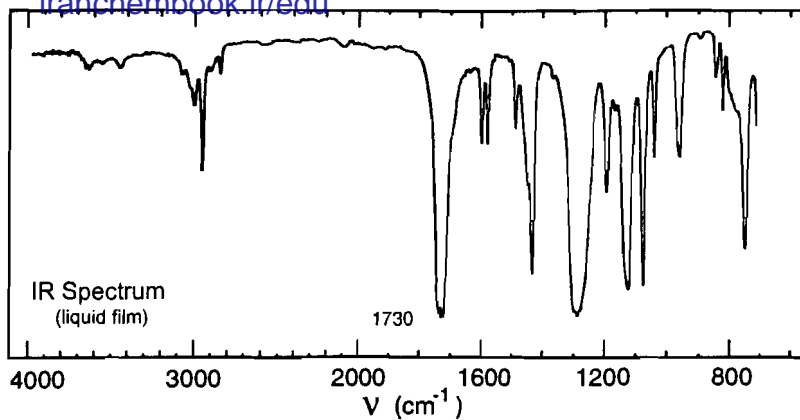

UV Spectrum

$\lambda_{\max}$  223 nm ( $\log_{10} \epsilon$  3.9)

$\lambda_{\max}$  275 nm ( $\log_{10} \epsilon$  3.1)

$\lambda_{\max}$  281 nm ( $\log_{10} \epsilon$  3.0)

solvent : ethanol

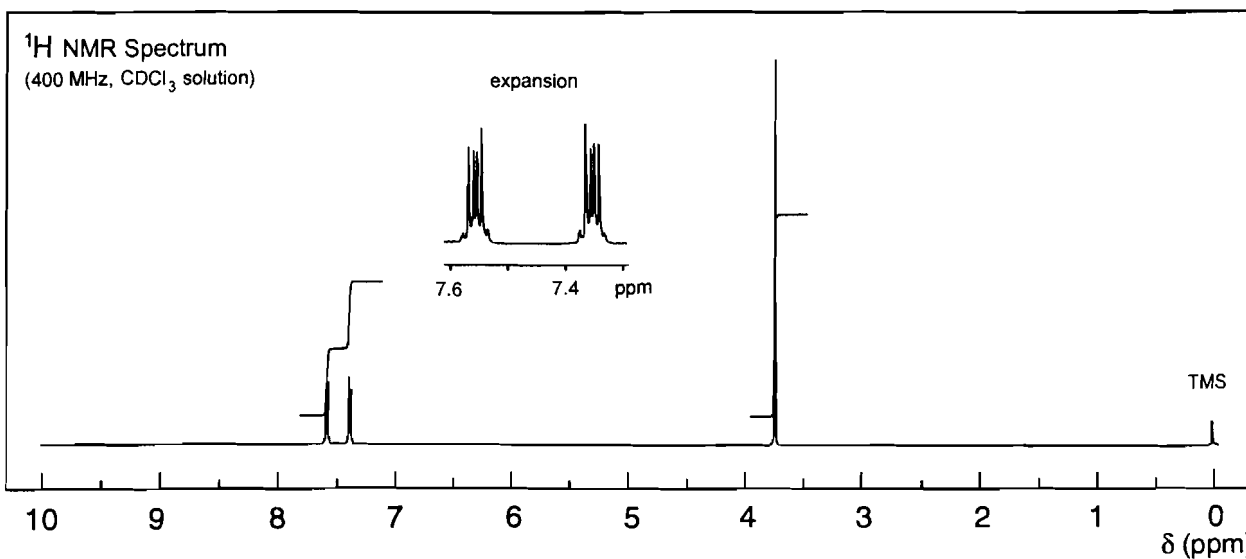
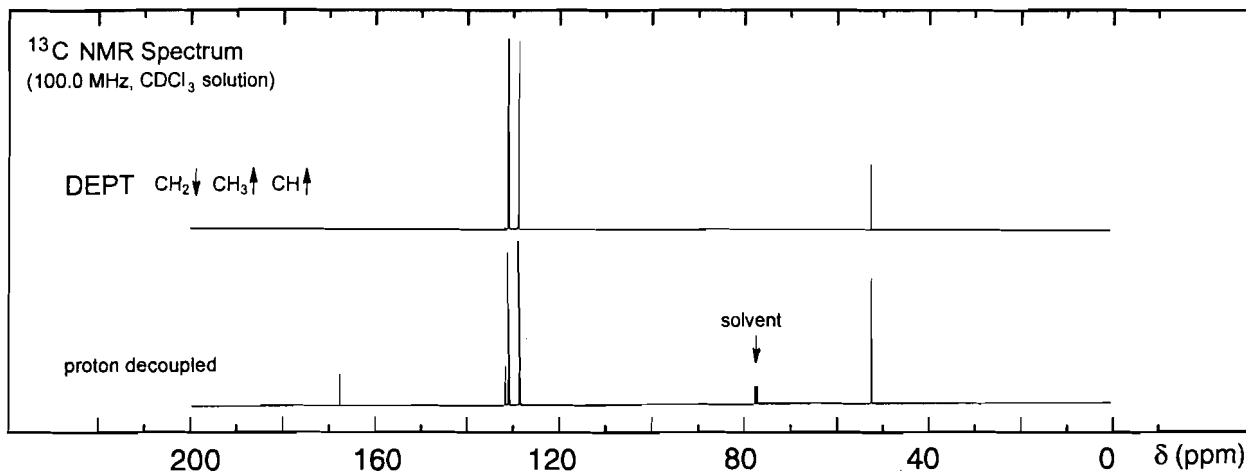

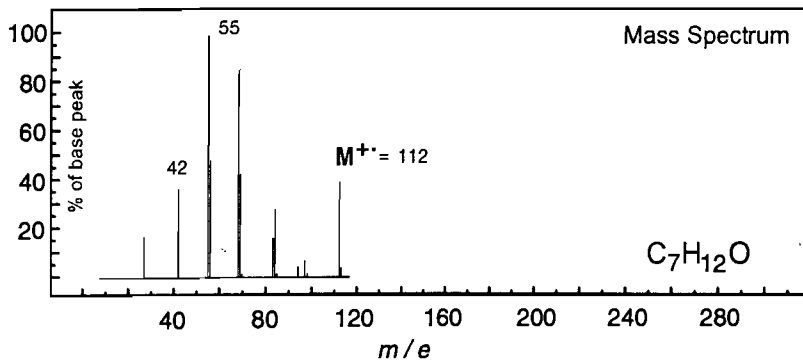
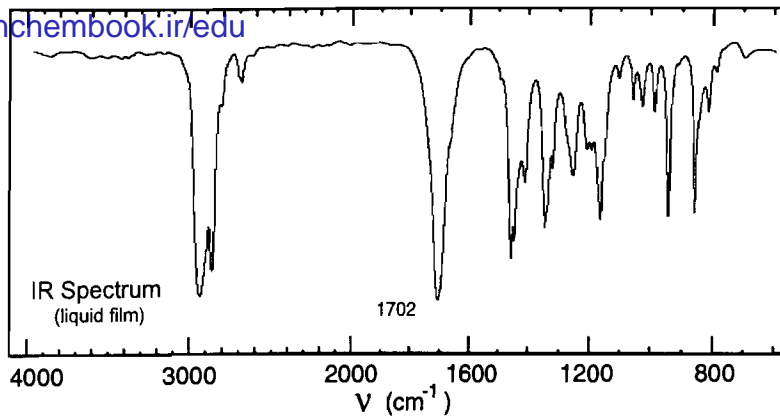

No significant UV  
absorption above 220 nm

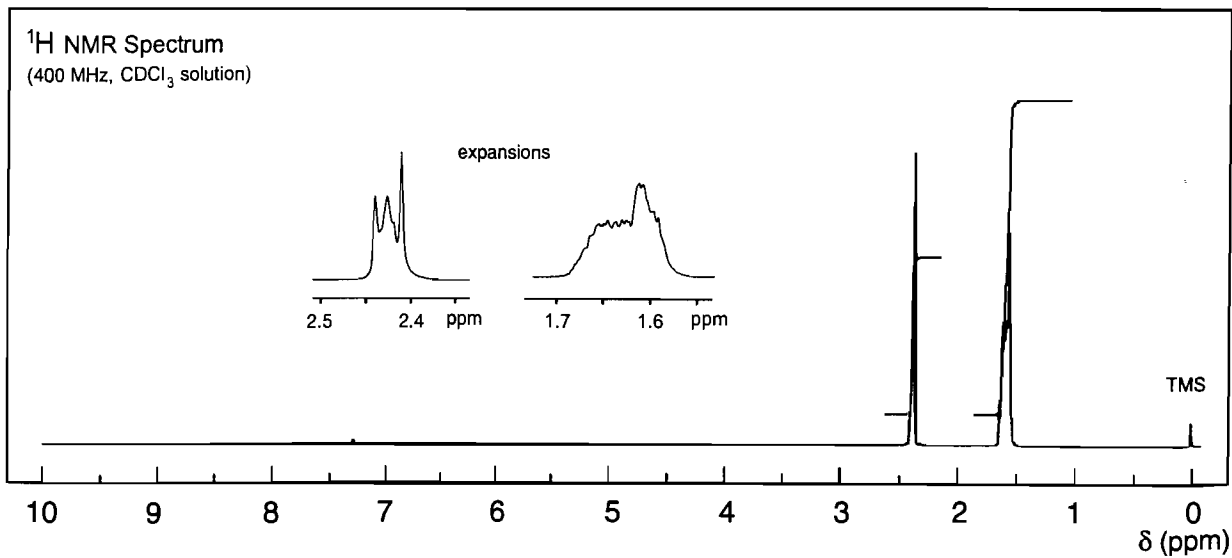
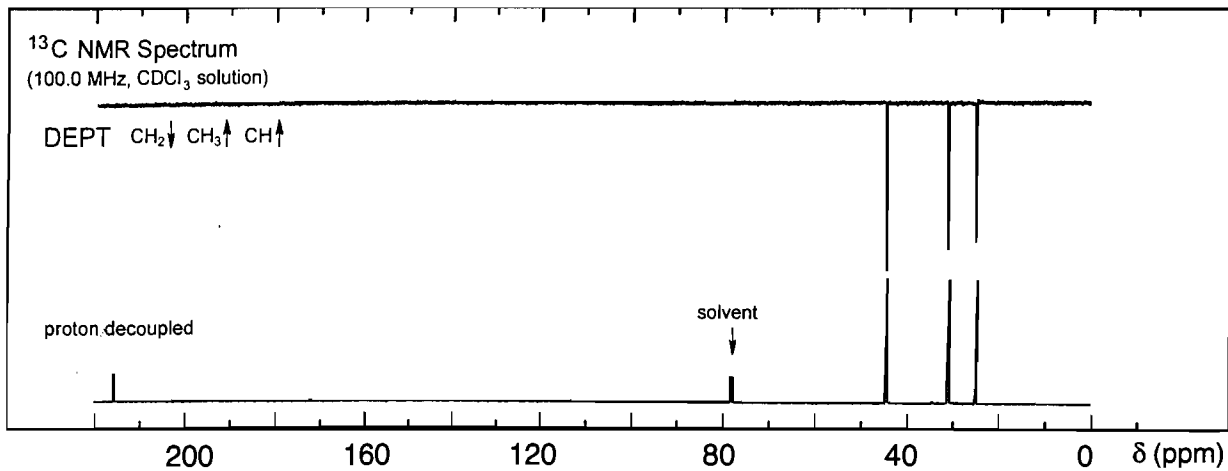

# Problem 140

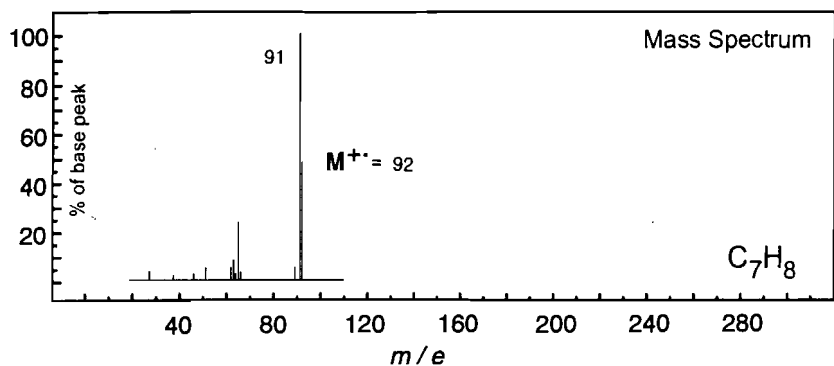
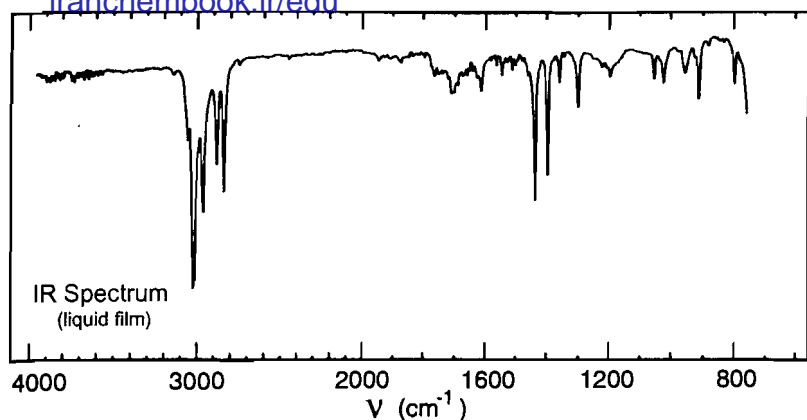

UV Spectrum

$\lambda_{\max}$  261 nm ( $\log_{10} \epsilon$  3.5)

solvent: ethanol

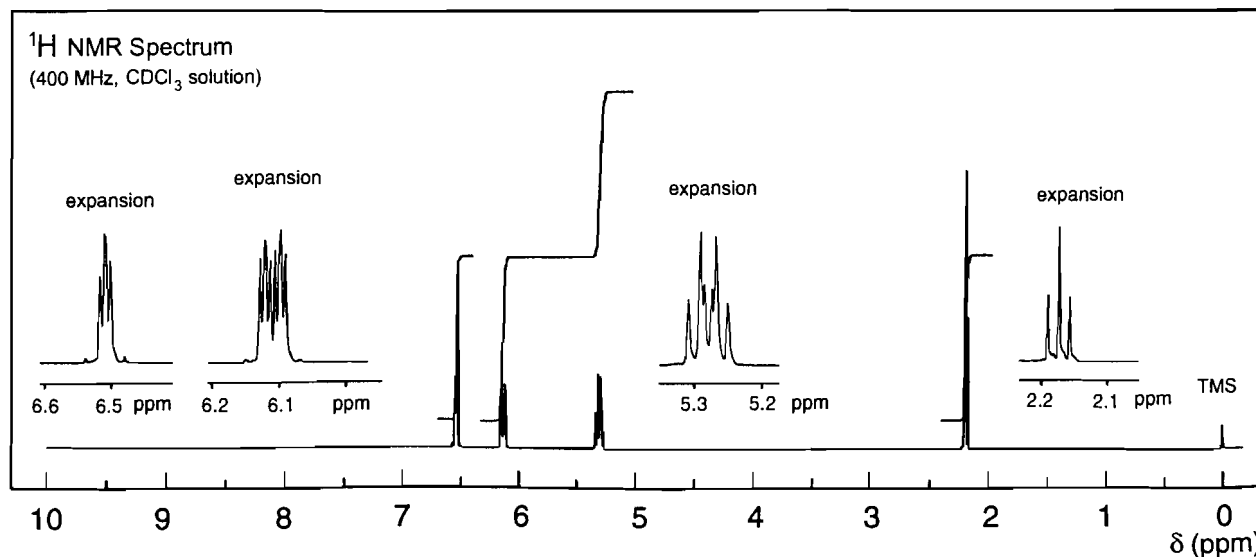
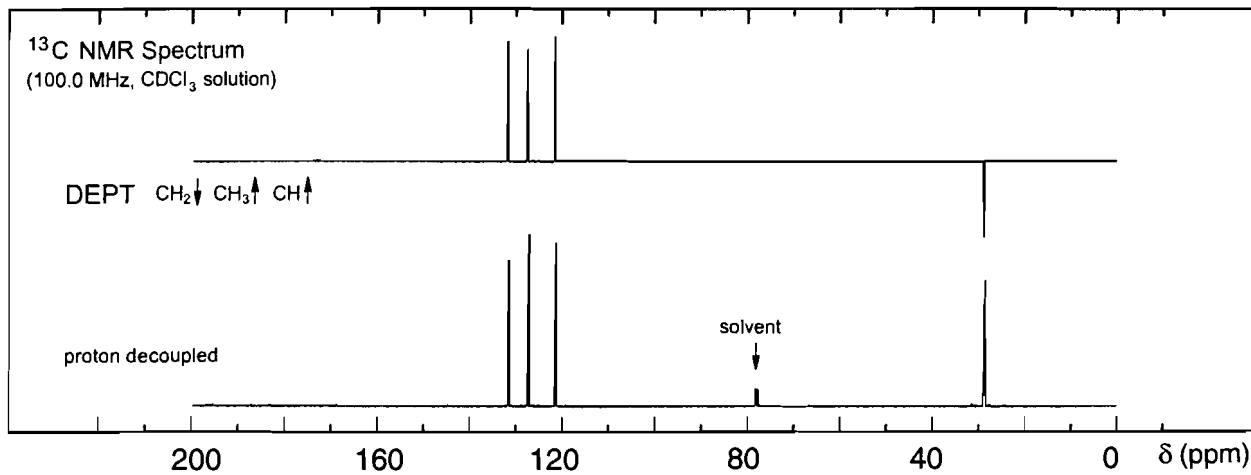

# Problem 141

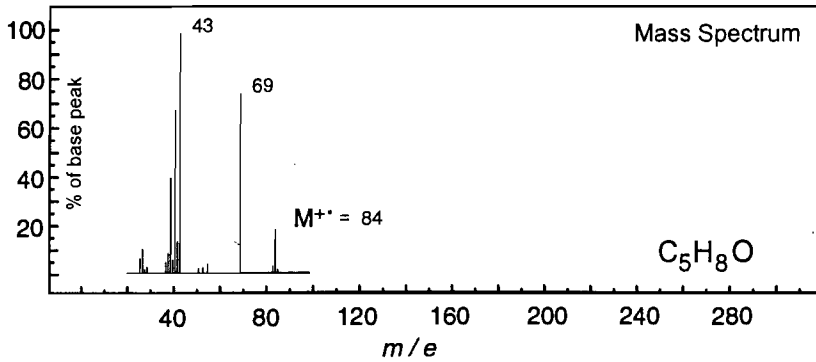
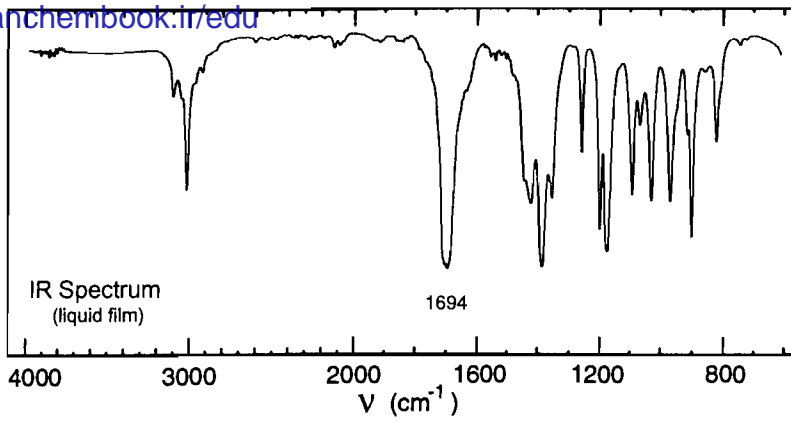

No significant UV  
absorption above 220 nm

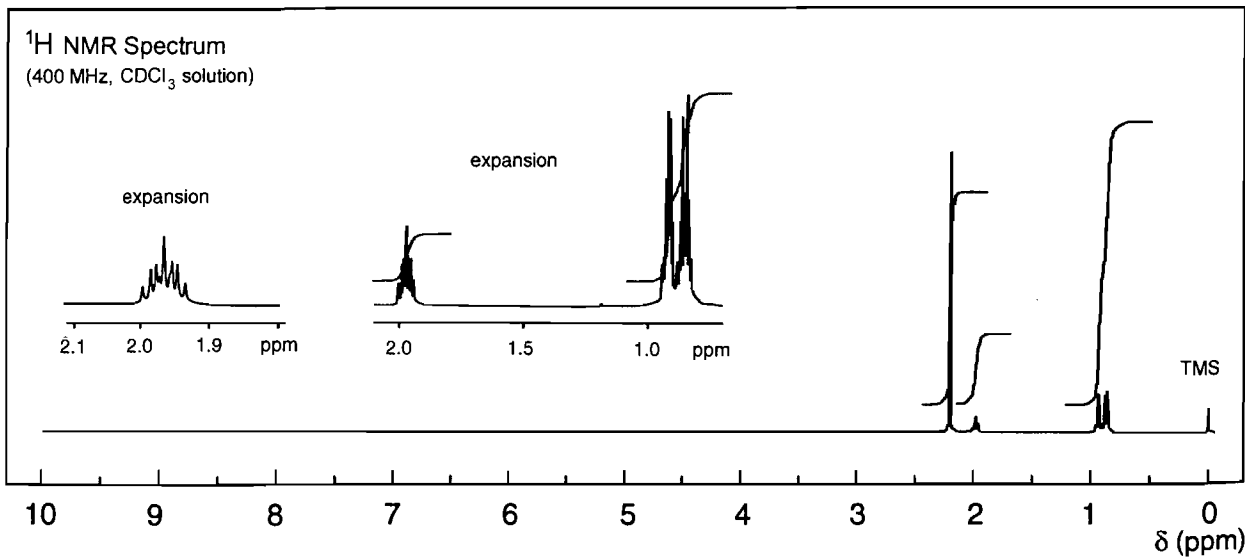
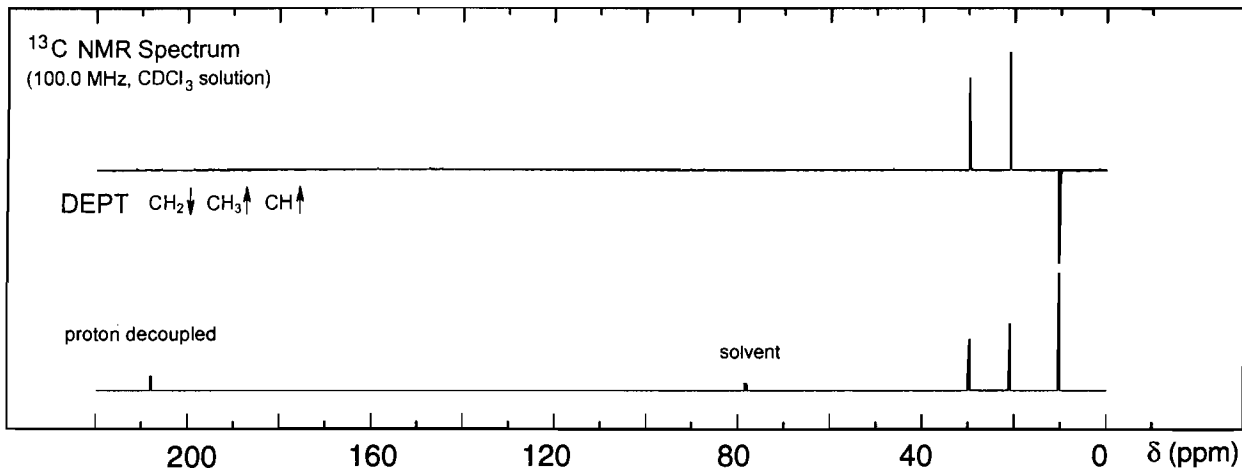

# Problem 142

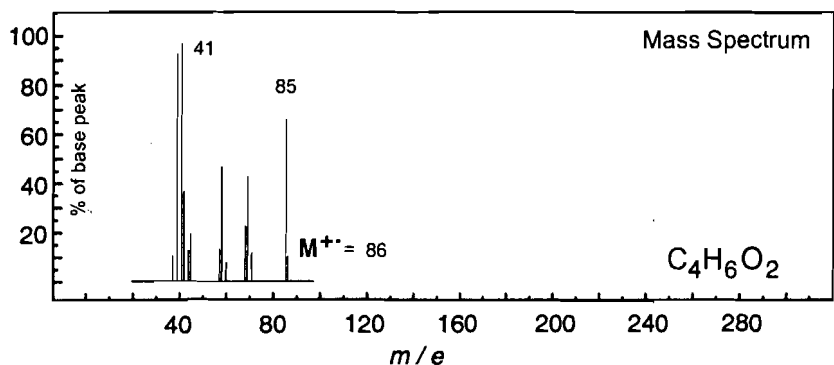
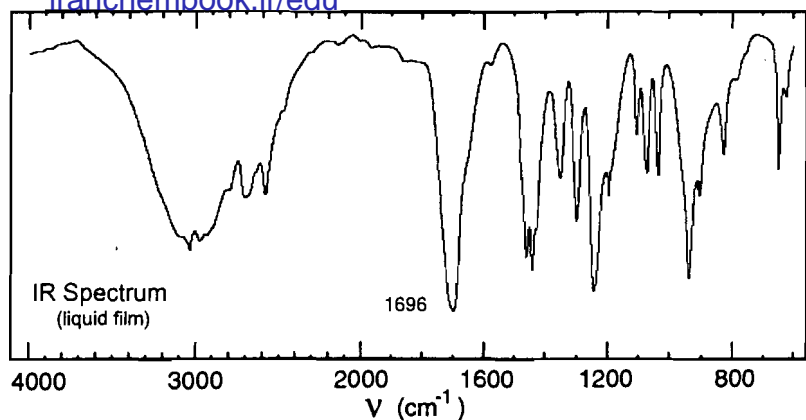

No significant UV absorption above 220 nm

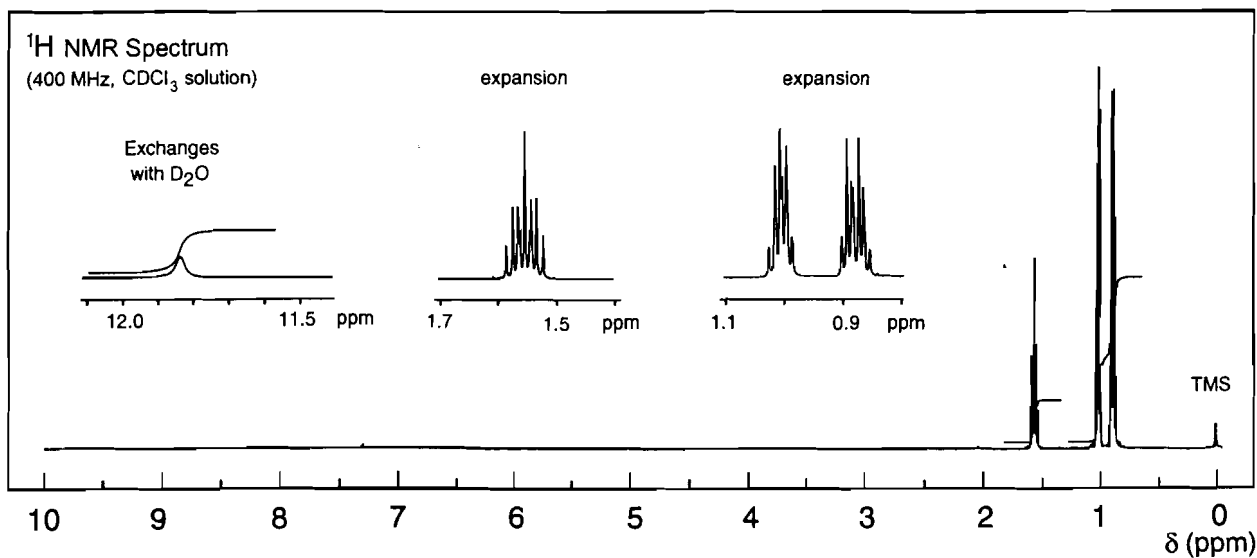
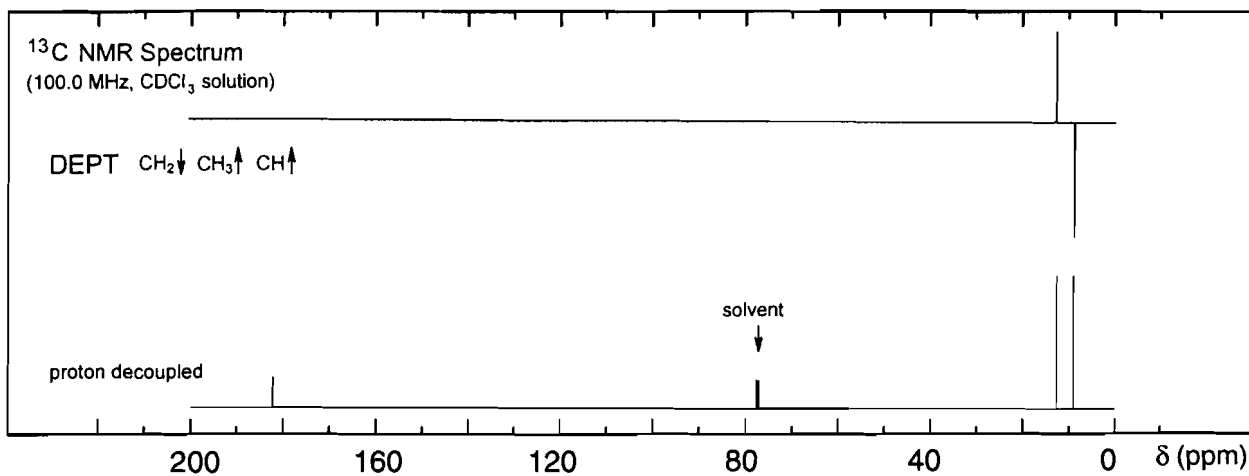



## Problem 143

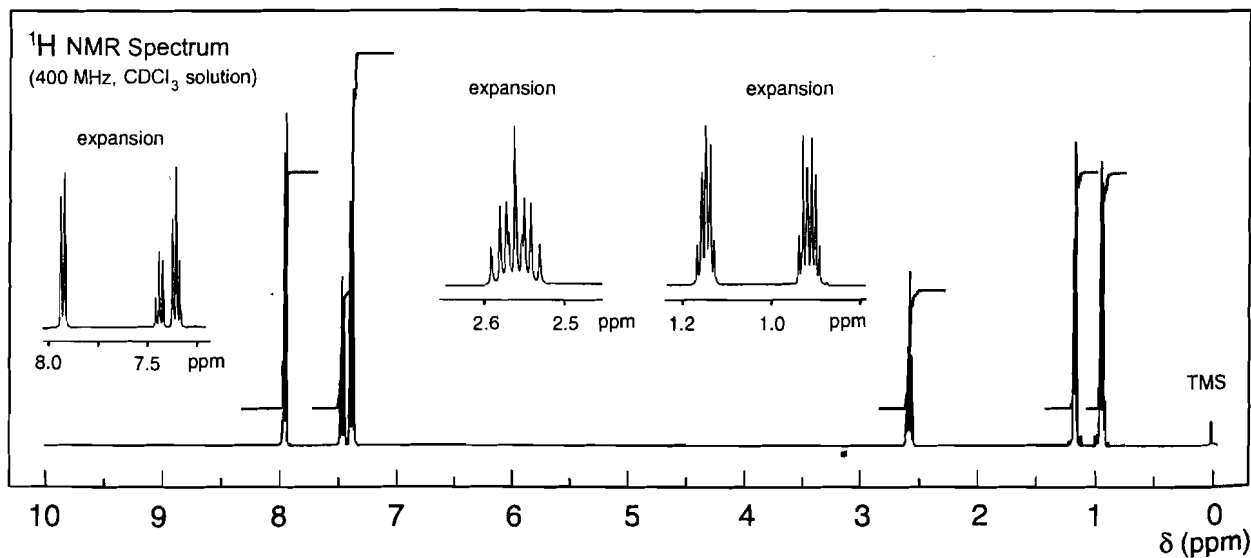
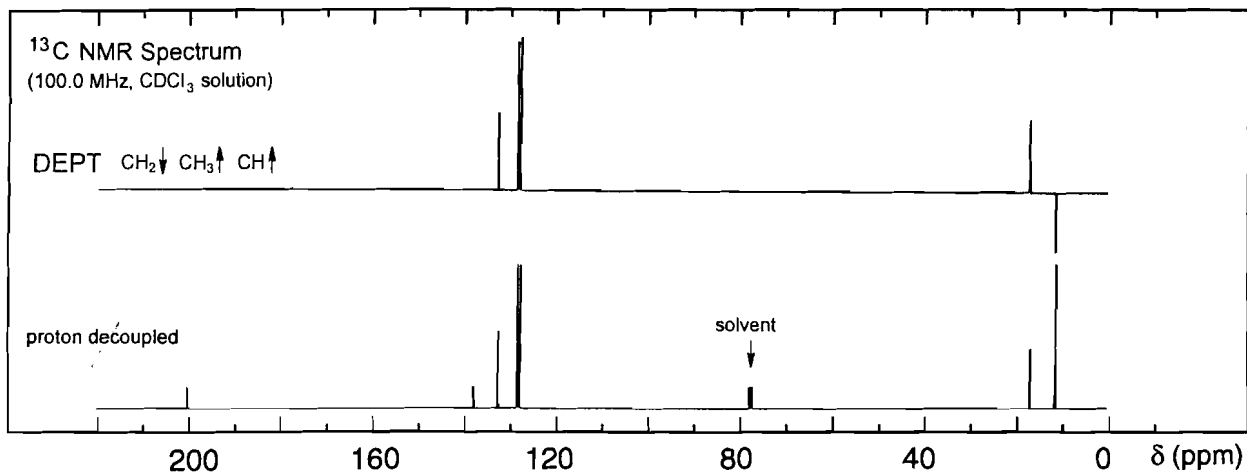
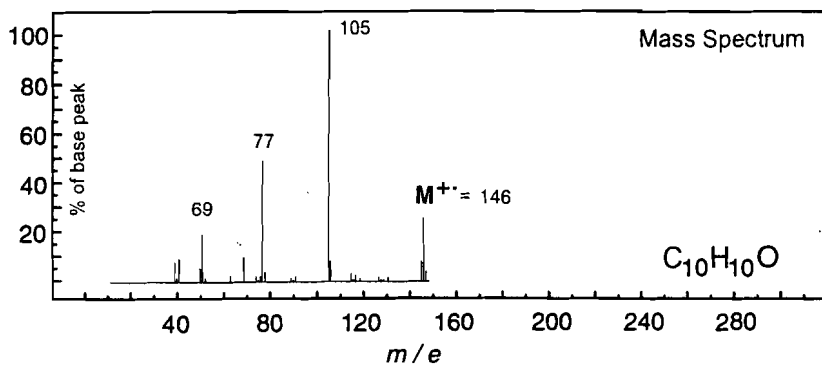
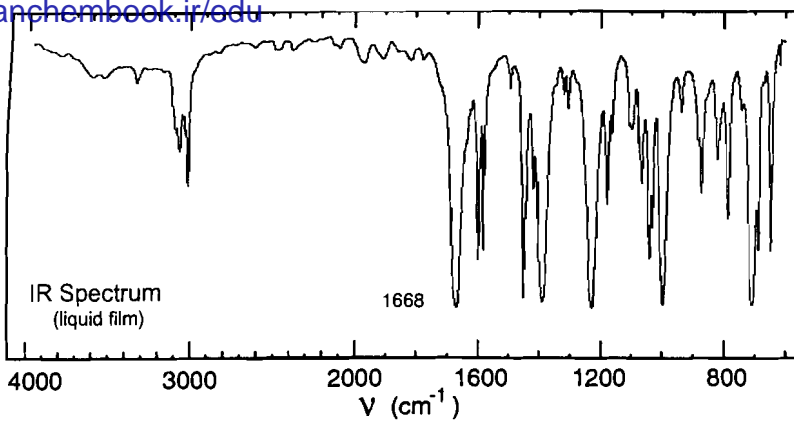

## Problem 144

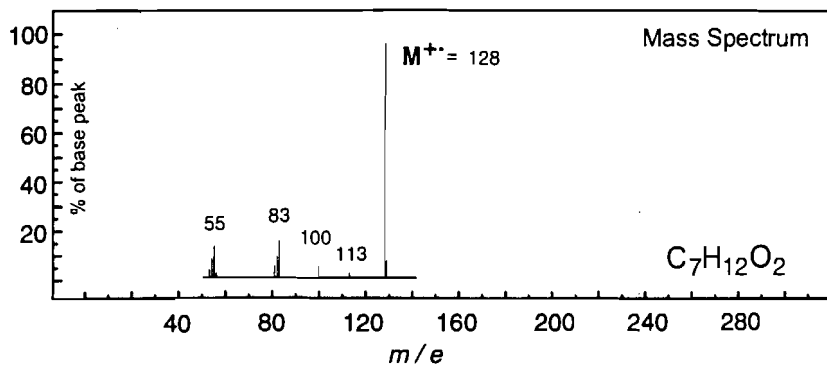
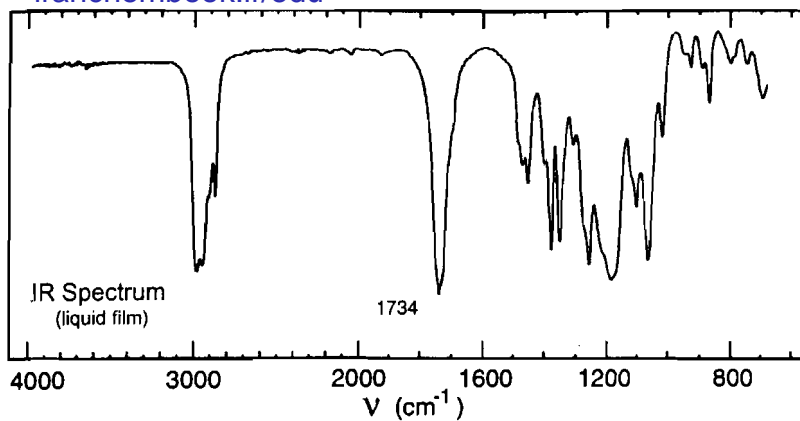

No significant UV  
absorption above 220 nm

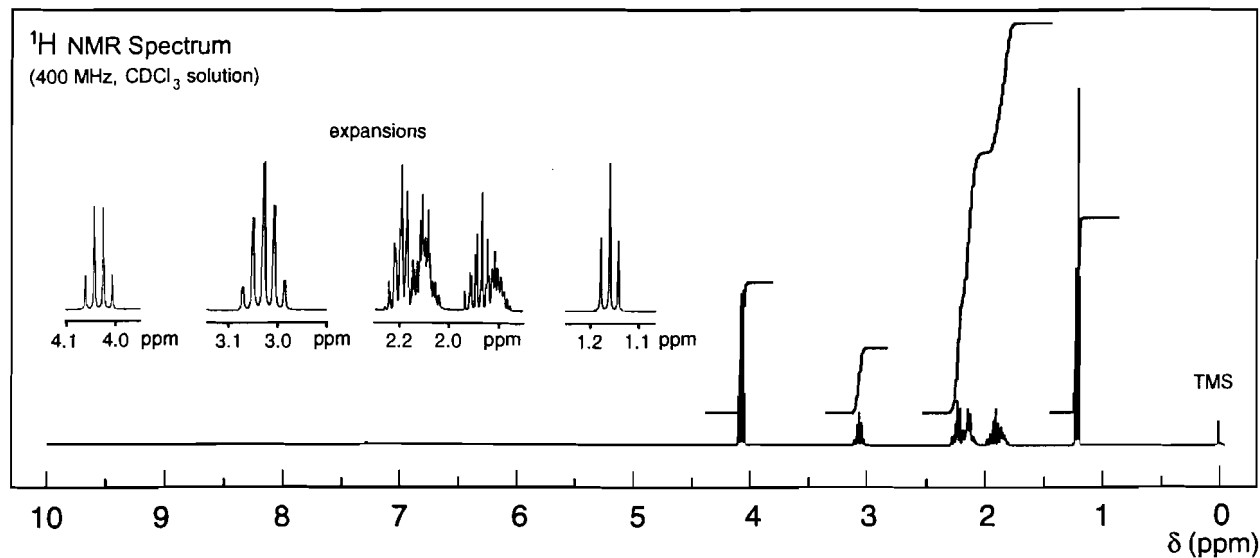
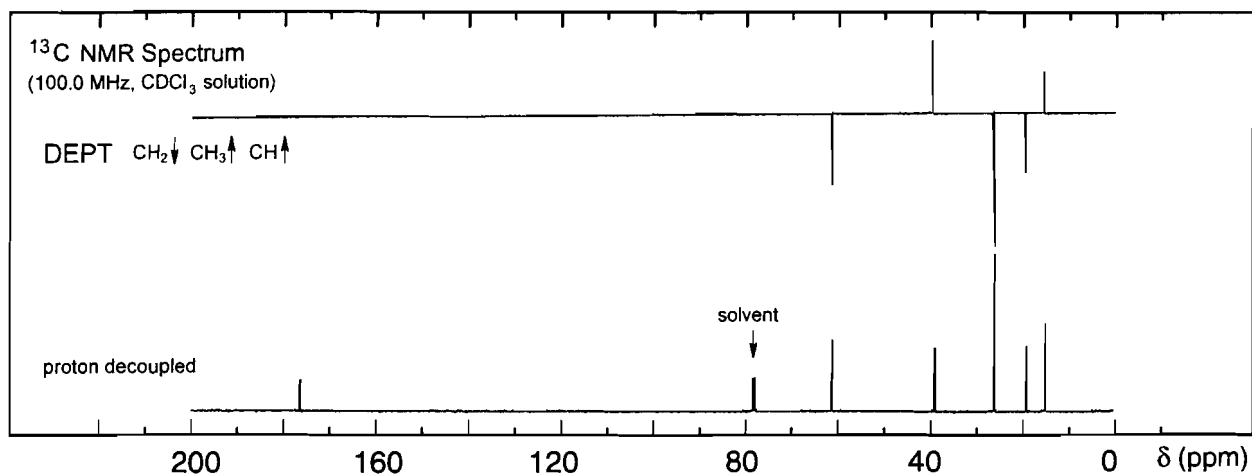

# Problem 145

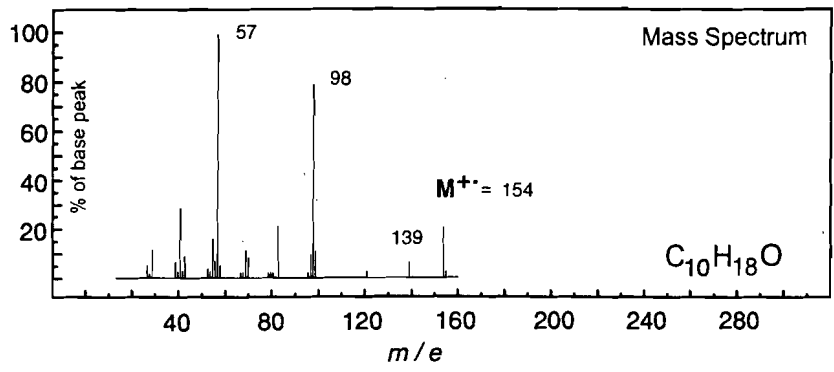
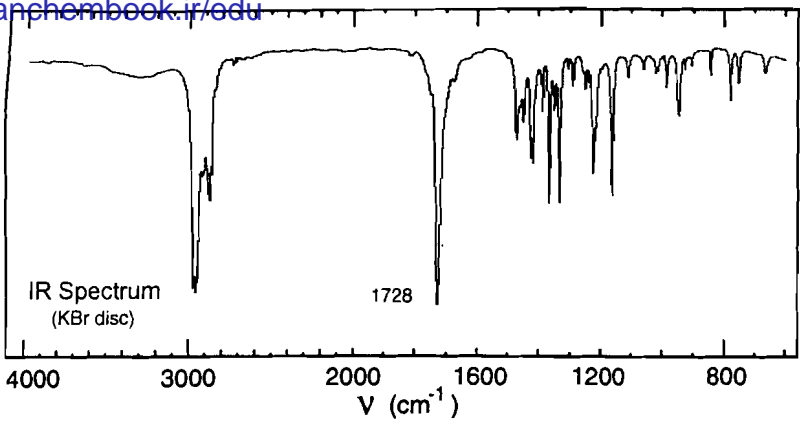

No significant UV absorption above 220 nm

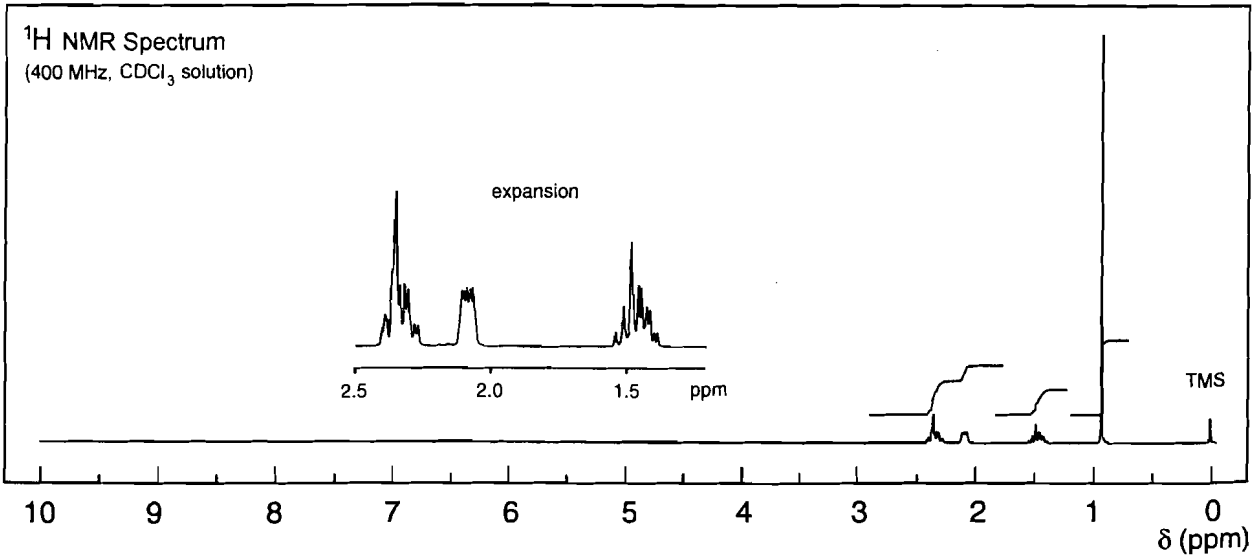
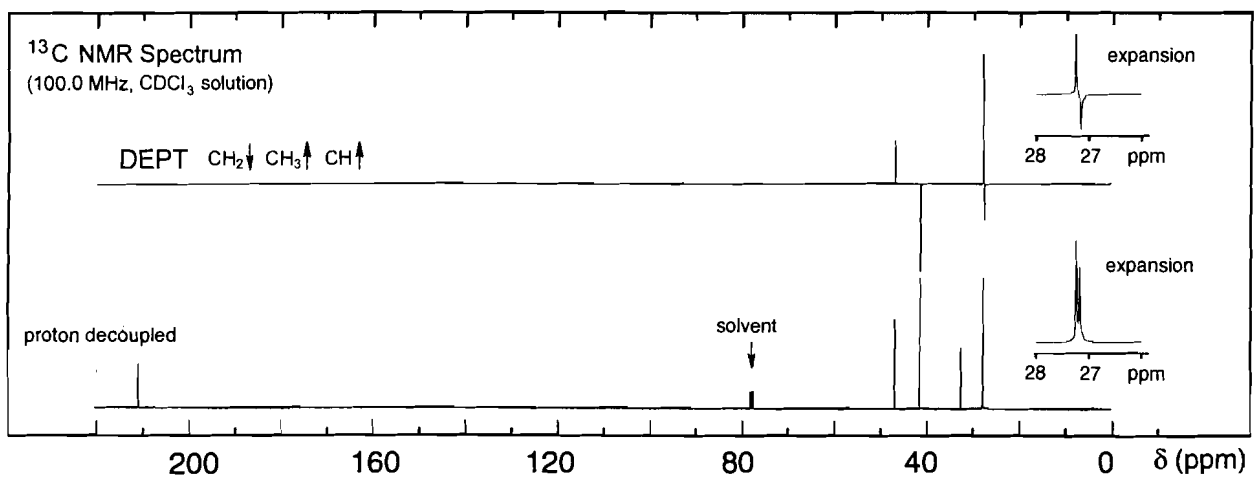

## Problem 146

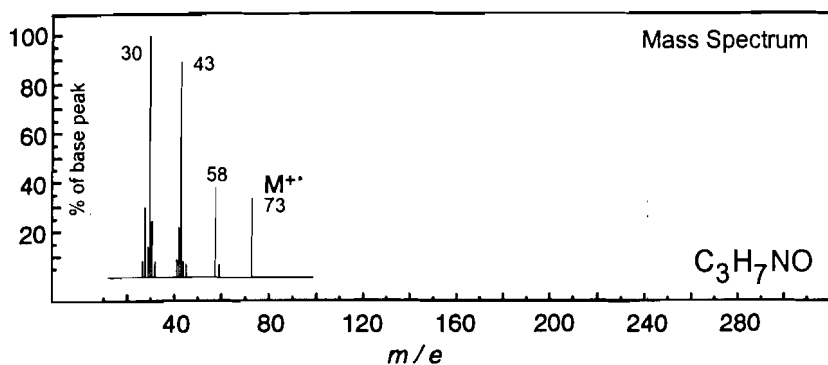
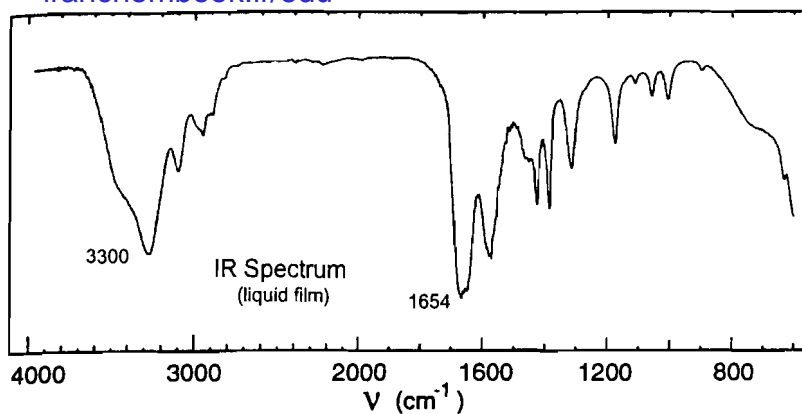

No significant UV  
absorption above 220 nm

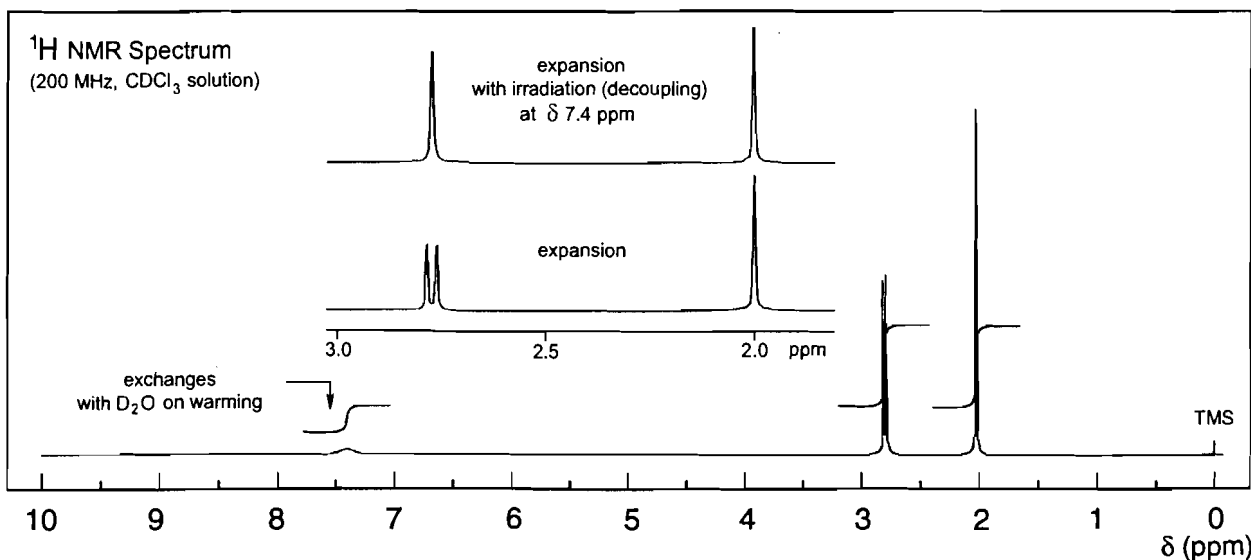
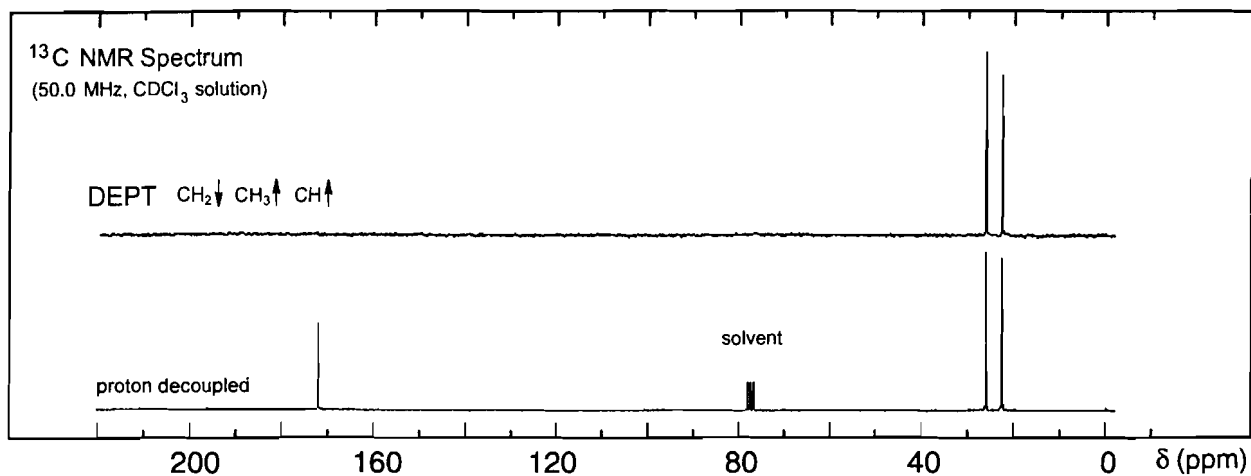

# Problem 147

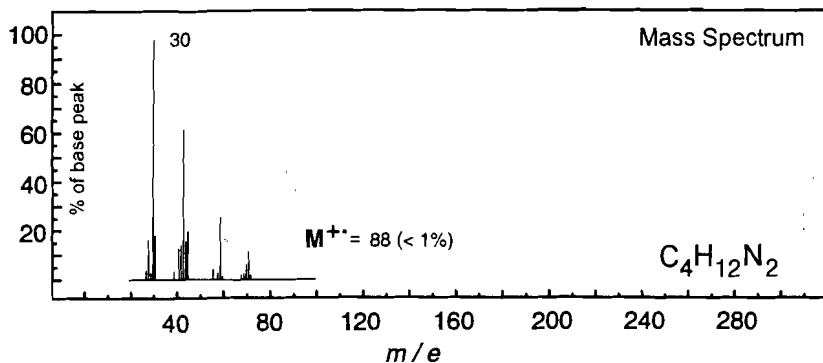
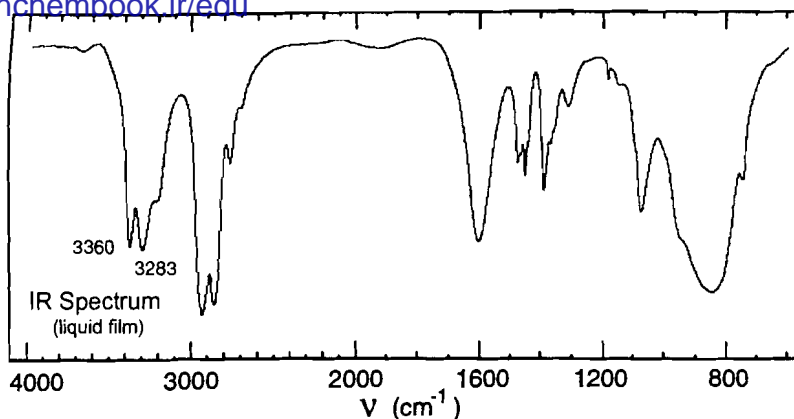

No significant UV absorption above 220 nm

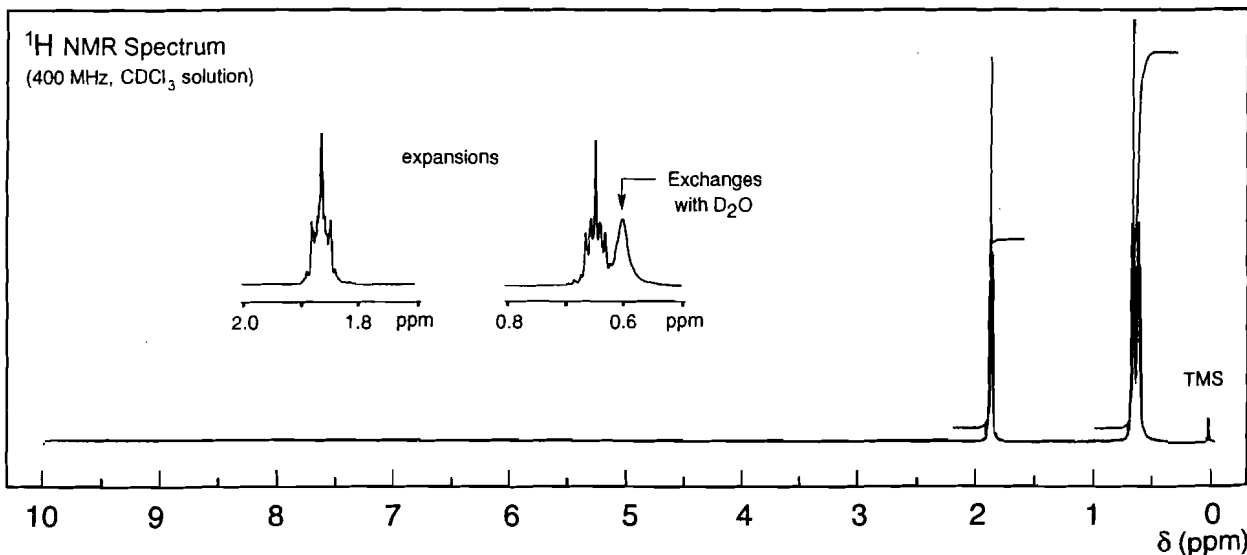
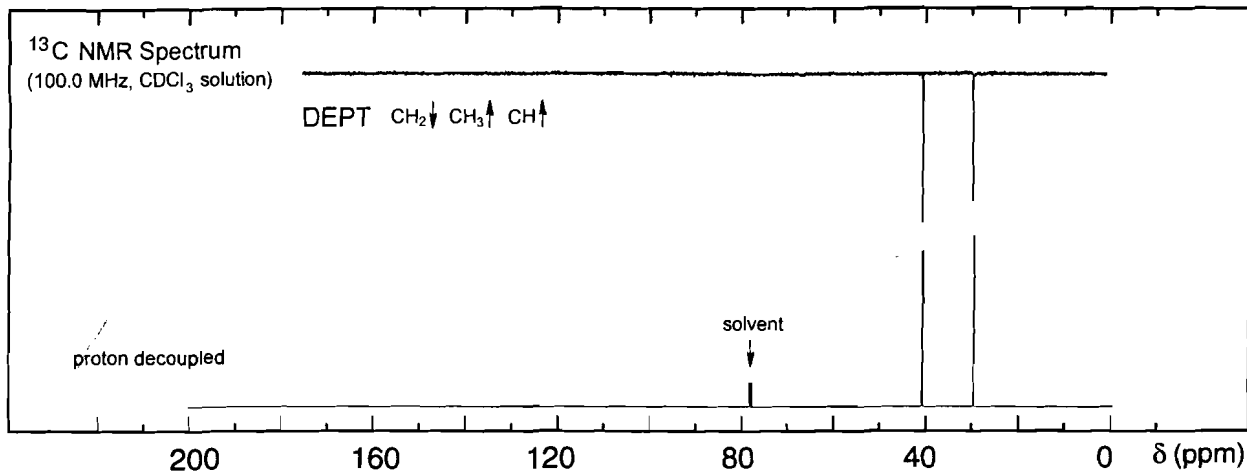

## Problem 148

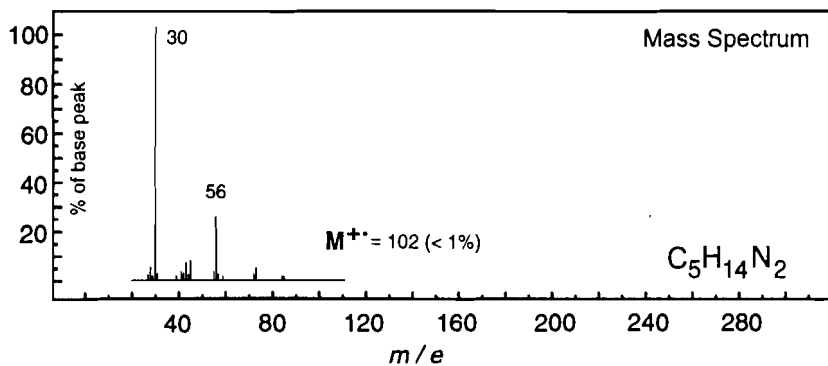
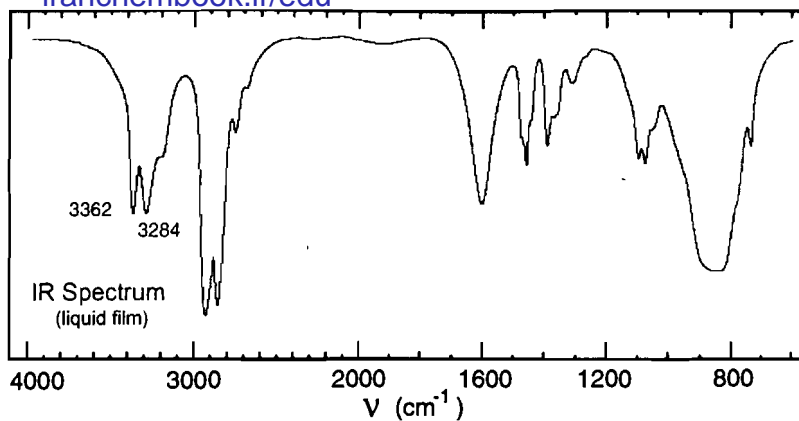

No significant UV  
absorption above 220 nm

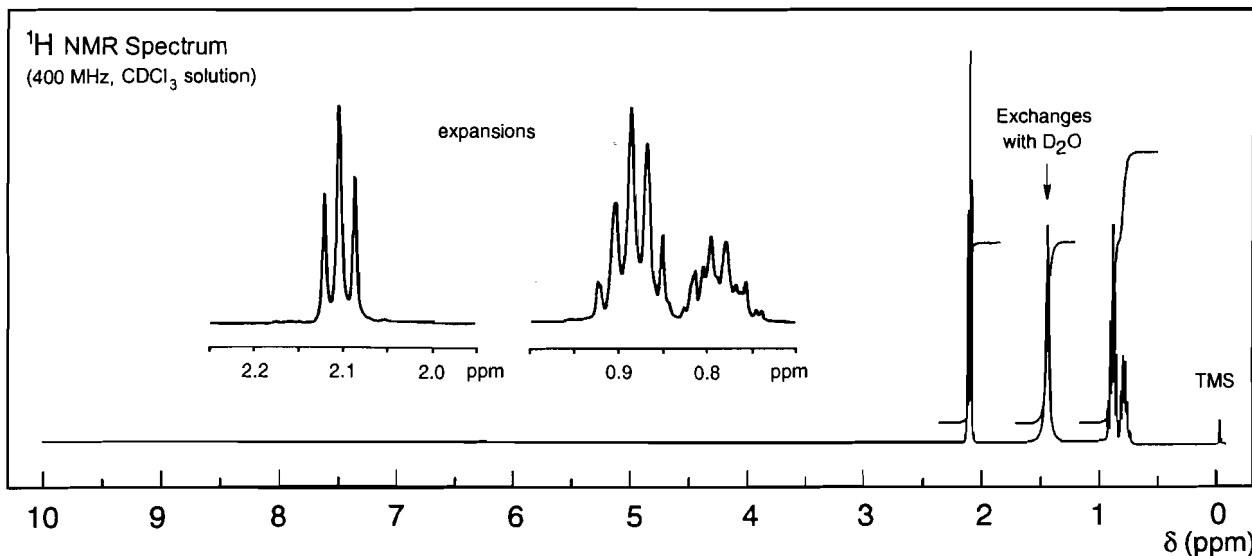
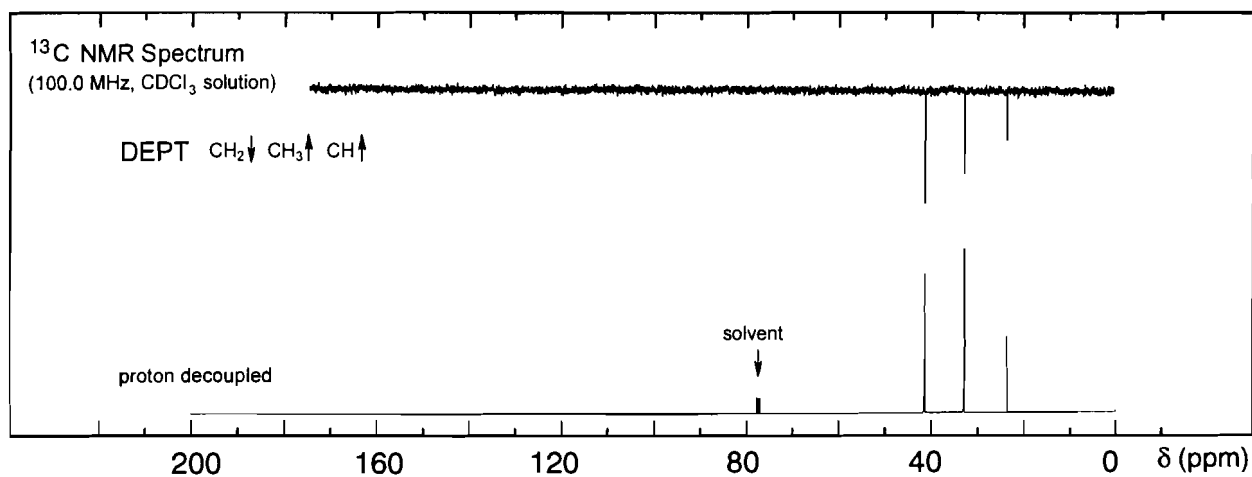

## Problem 149

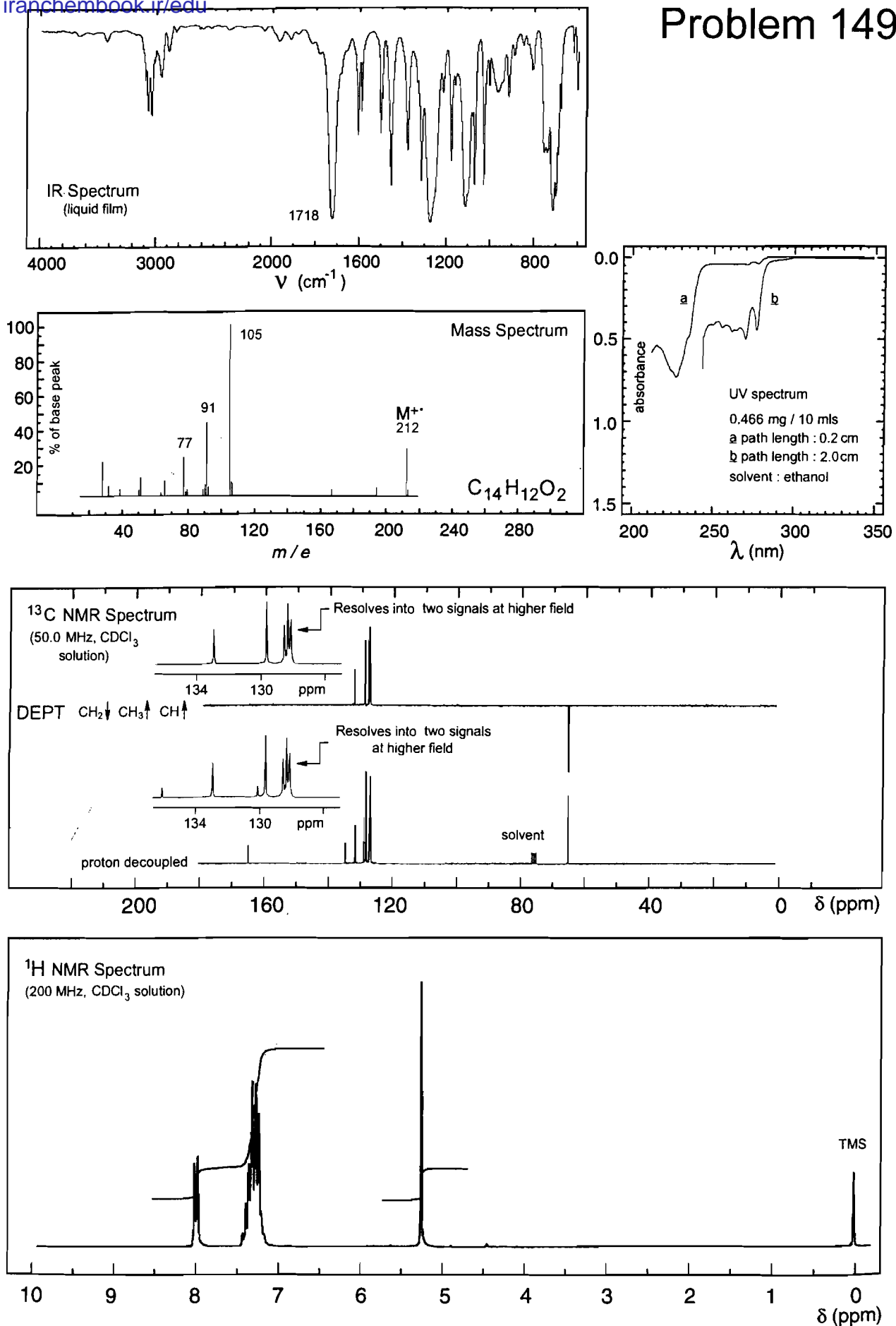

## Problem 150

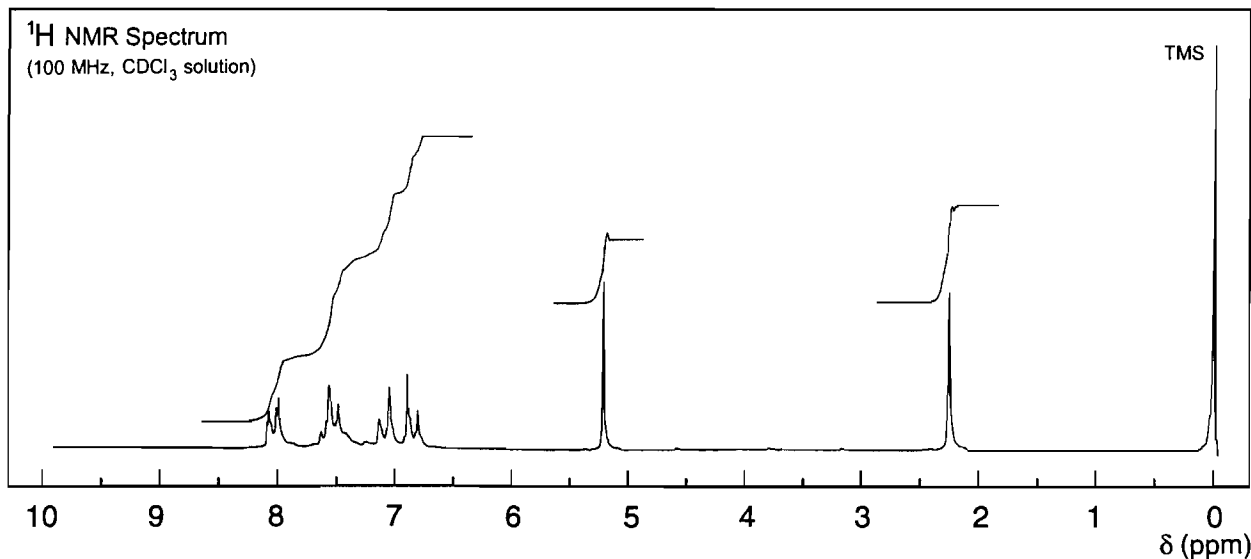
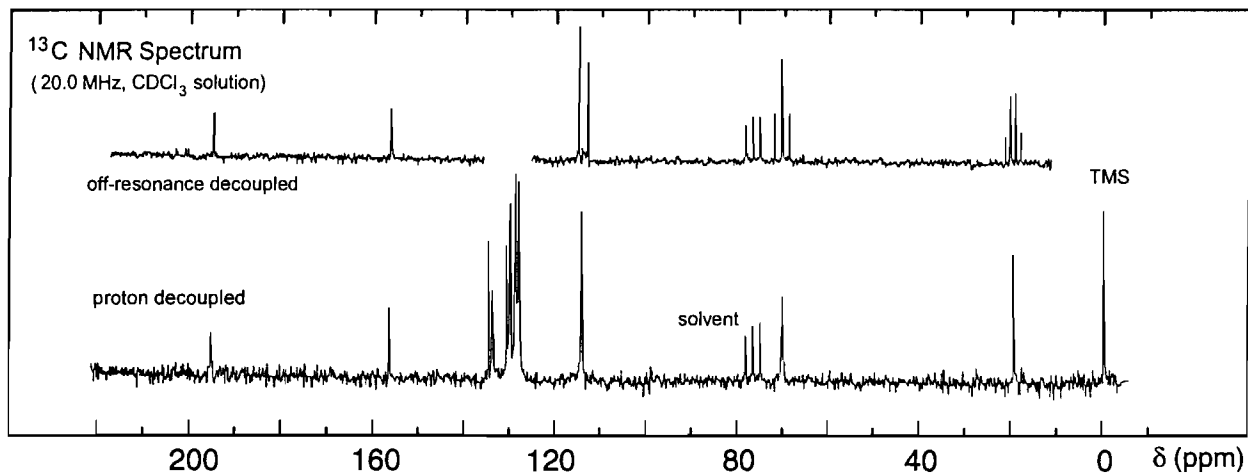
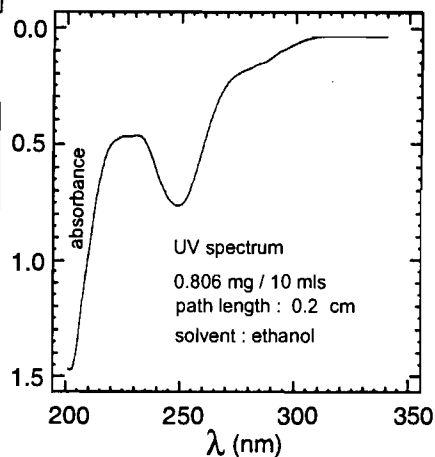
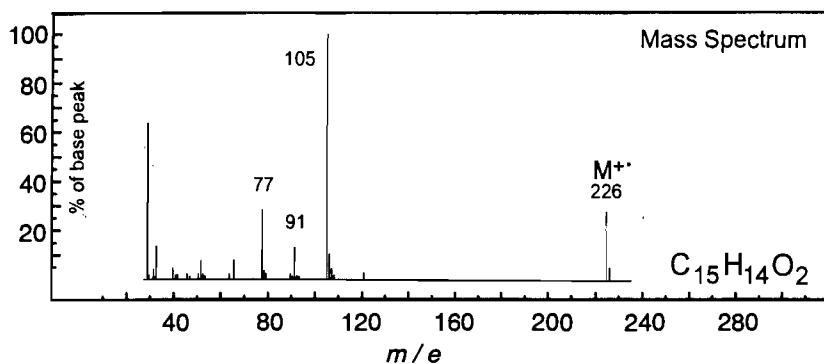
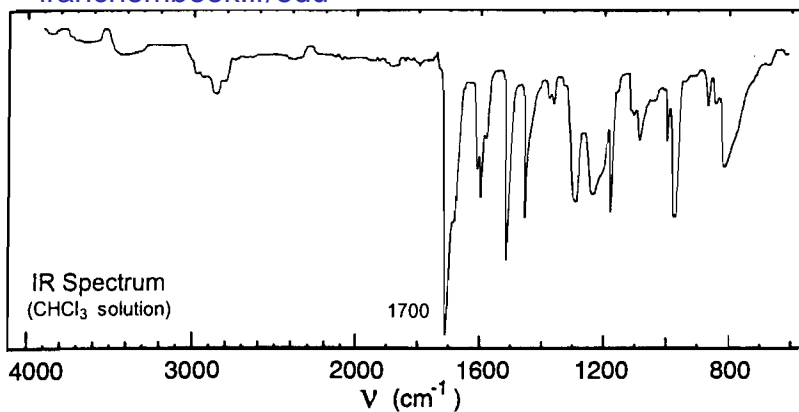



## Problem 151

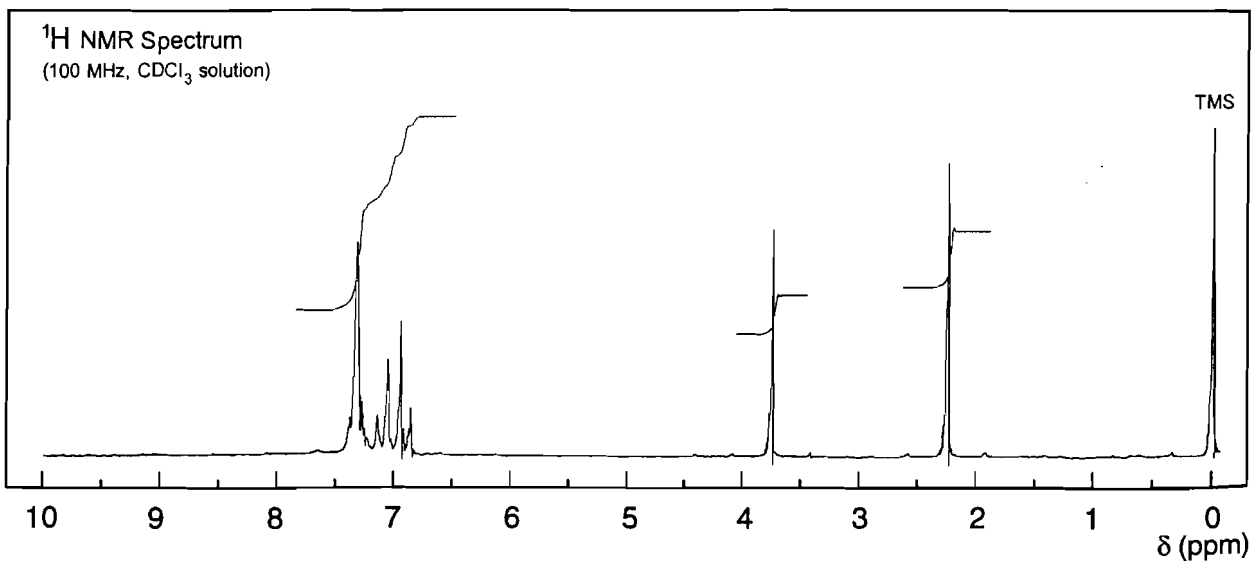
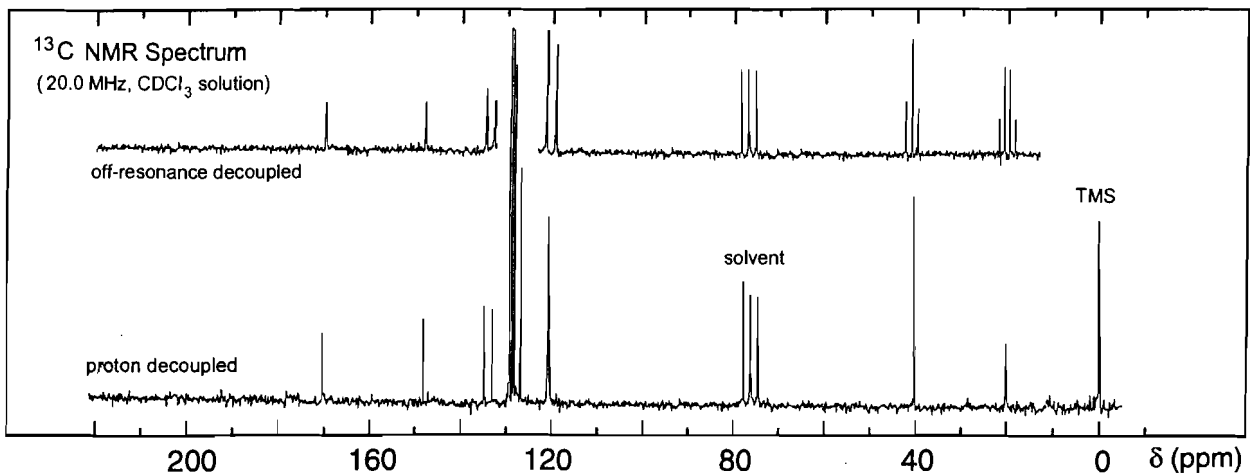
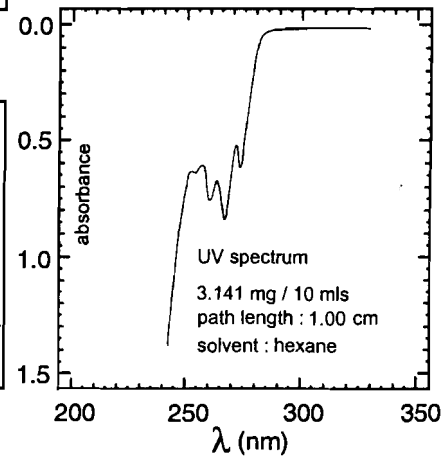
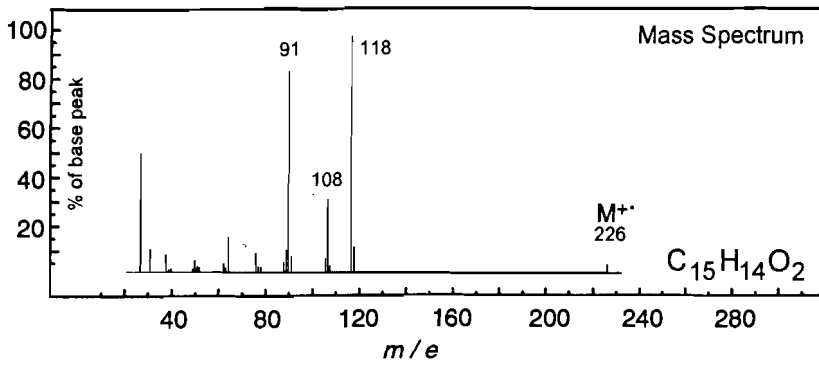
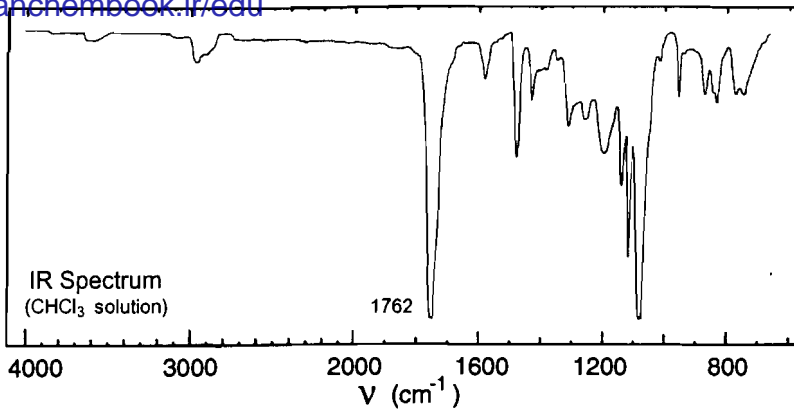

## Problem 152

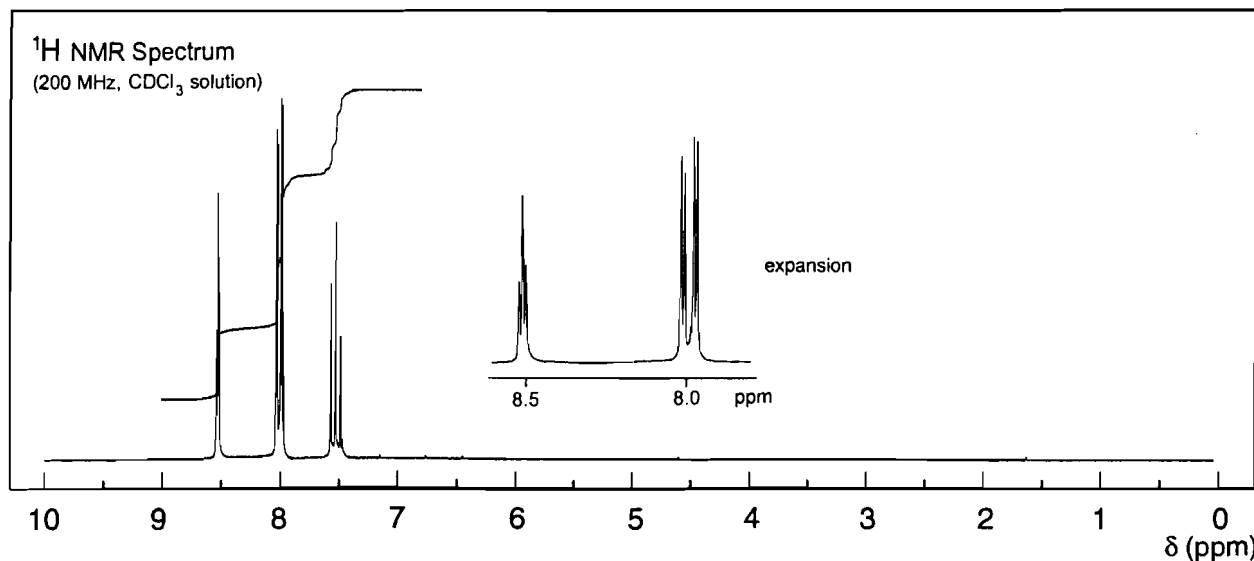
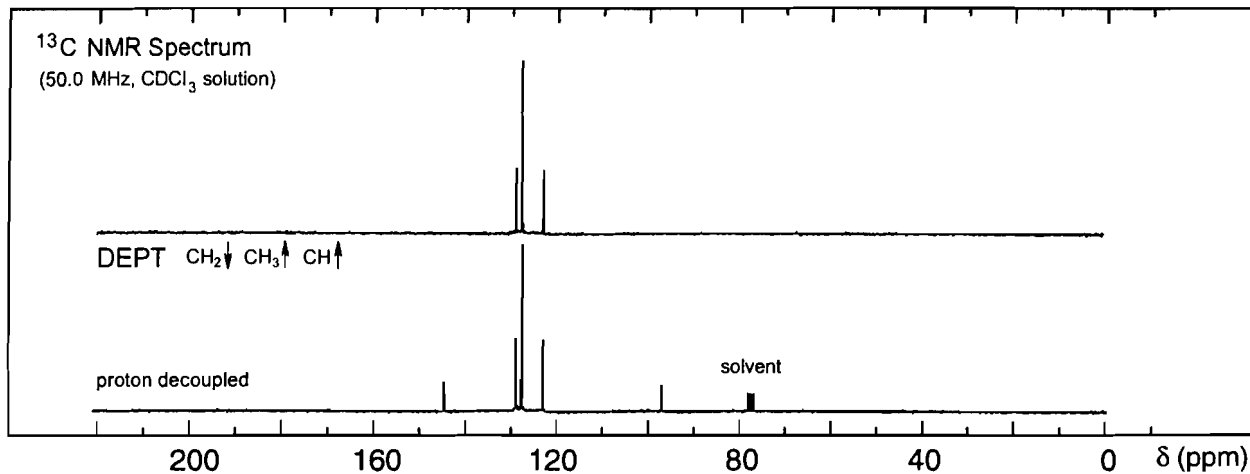
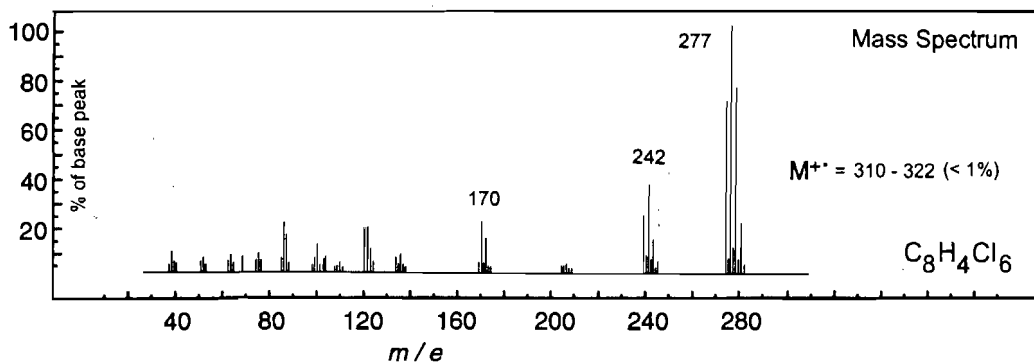
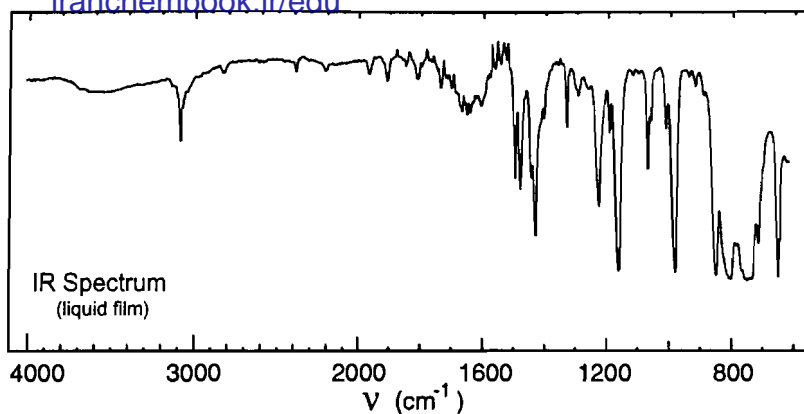

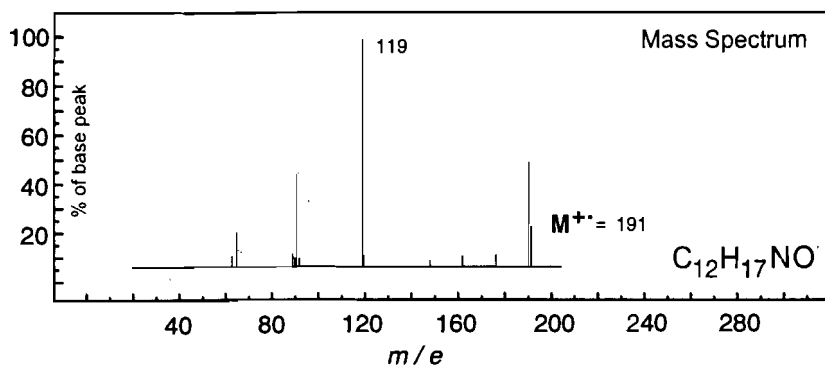
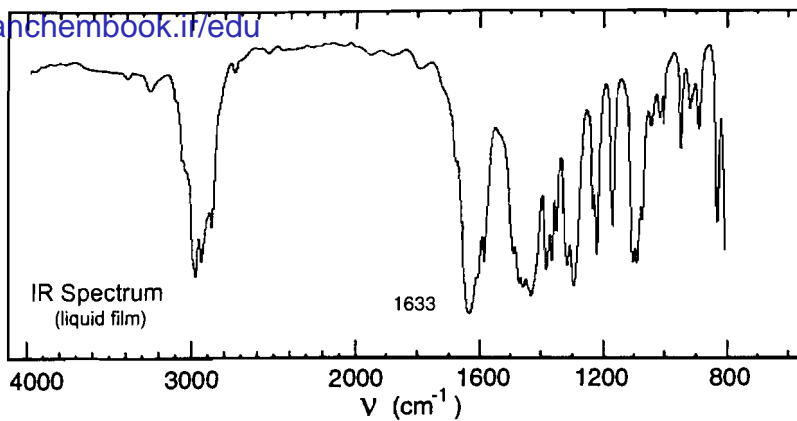

UV Spectrum

 $\lambda_{\text{max}}$  246 nm ( $\log_{10} \epsilon$  3.7) $\lambda_{\text{max}}$  273 nm ( $\log_{10} \epsilon$  2.6)

solvent: ethanol

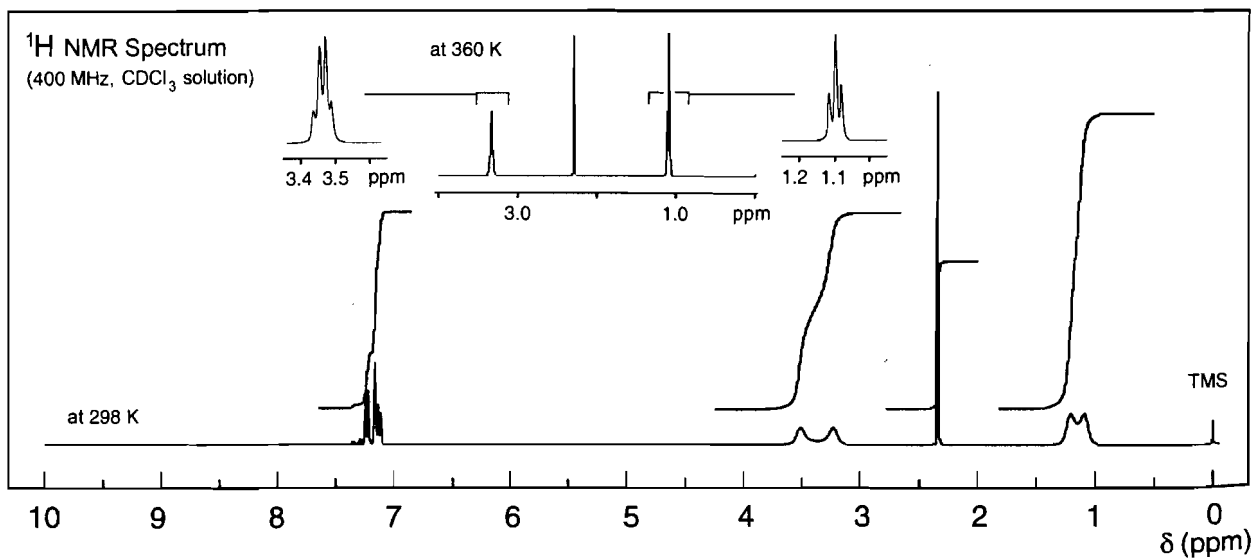
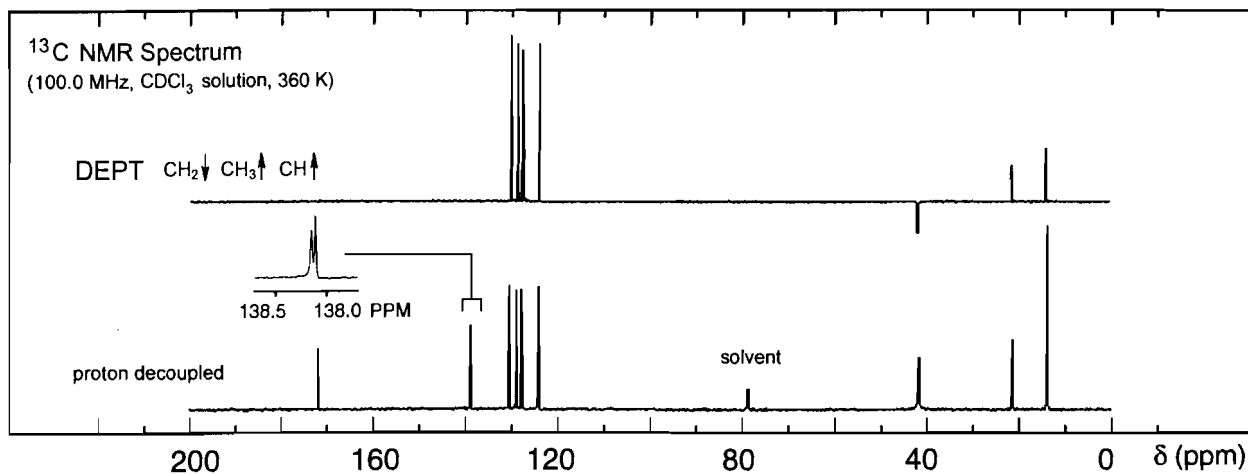

## Problem 154

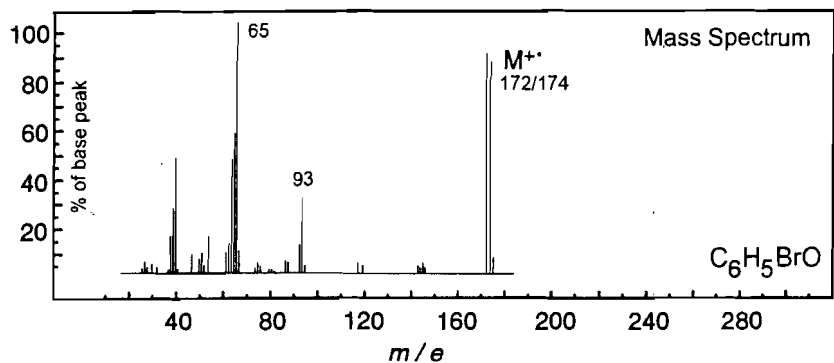
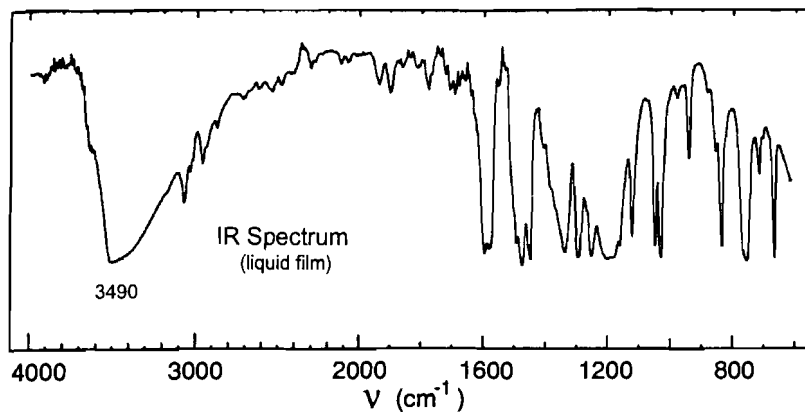

UV Spectrum

$$\lambda_{\text{max}} 277 \text{ nm } (\log_{10} \epsilon 3.4)$$

solvent : methanol

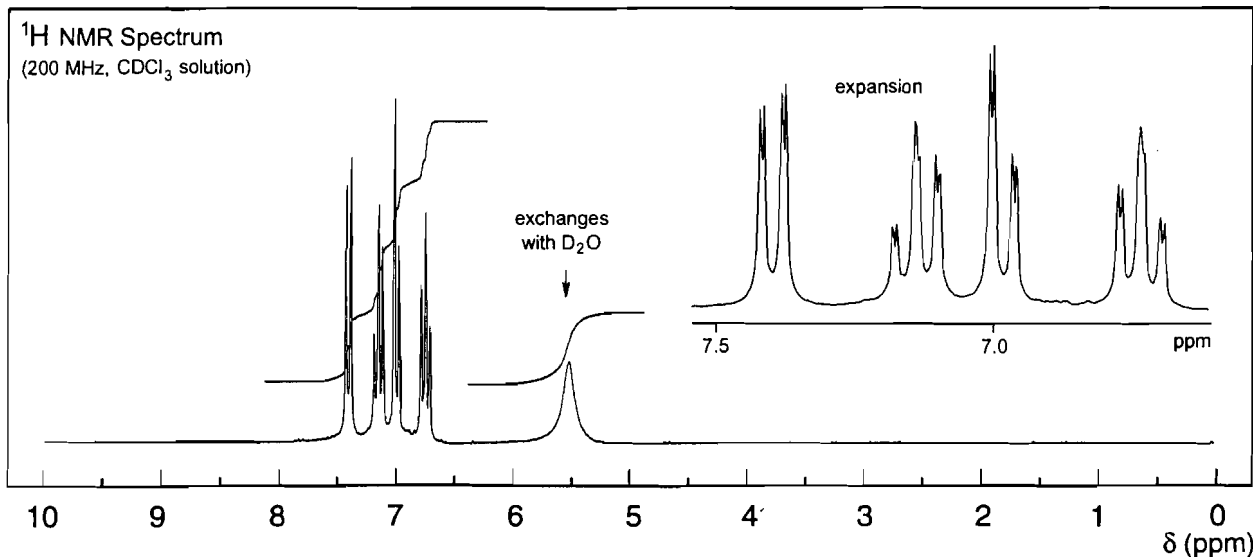
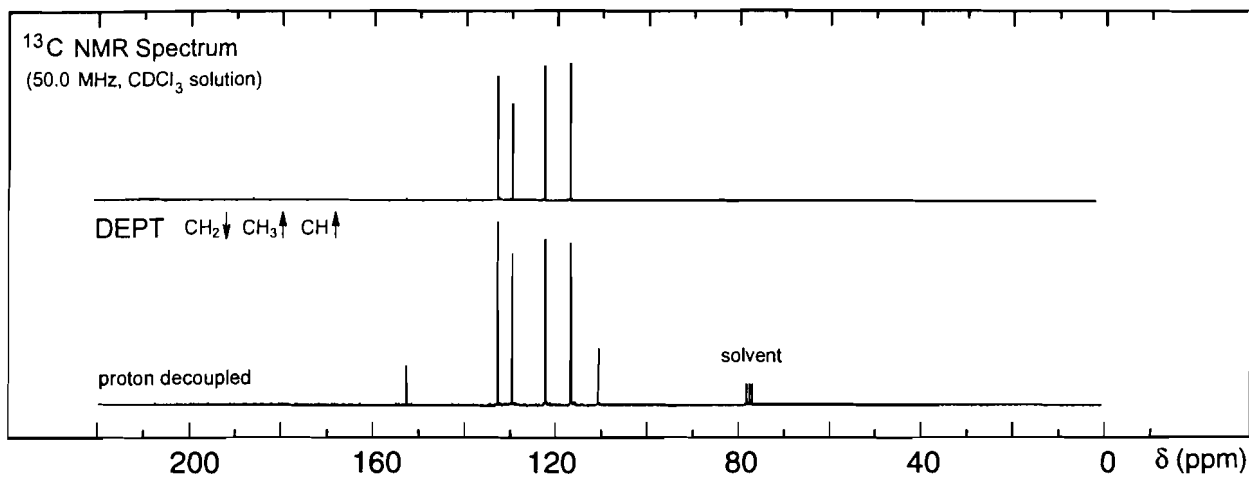

## Problem 155

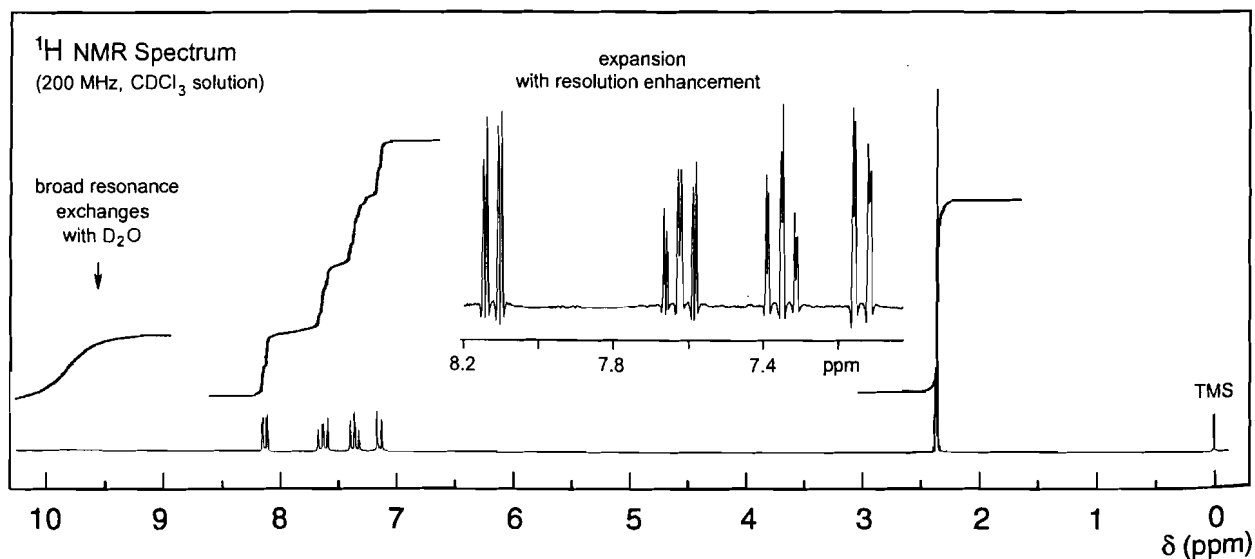
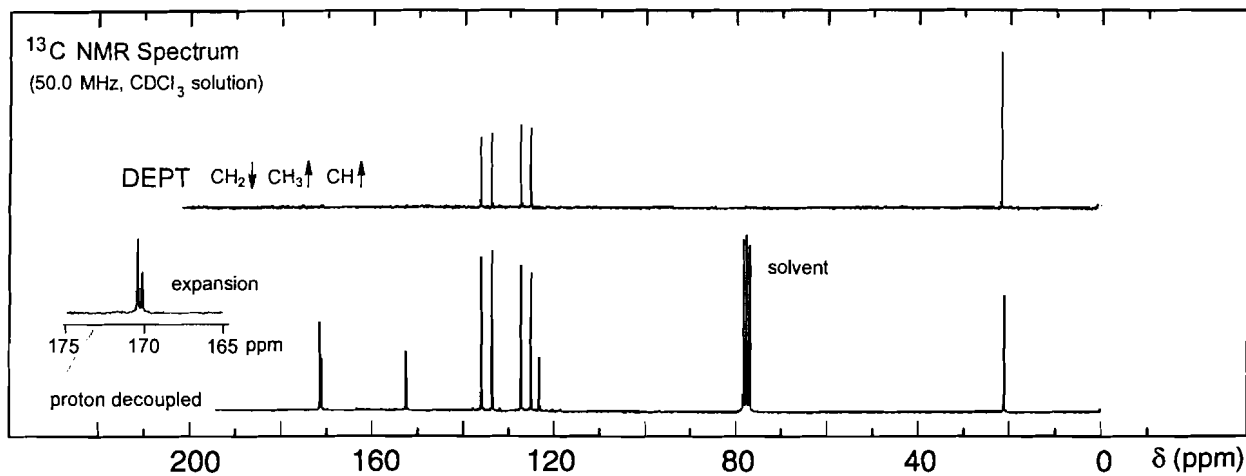
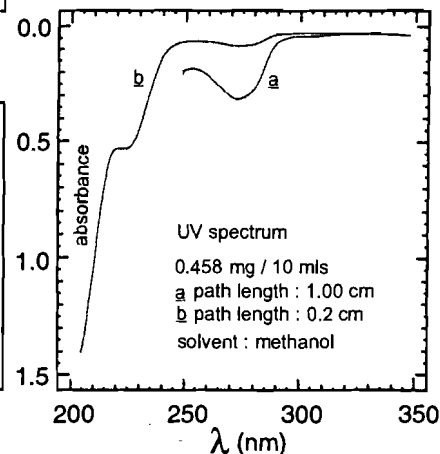
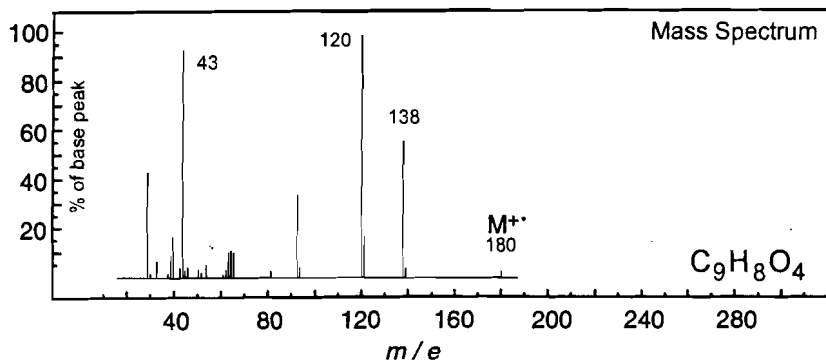
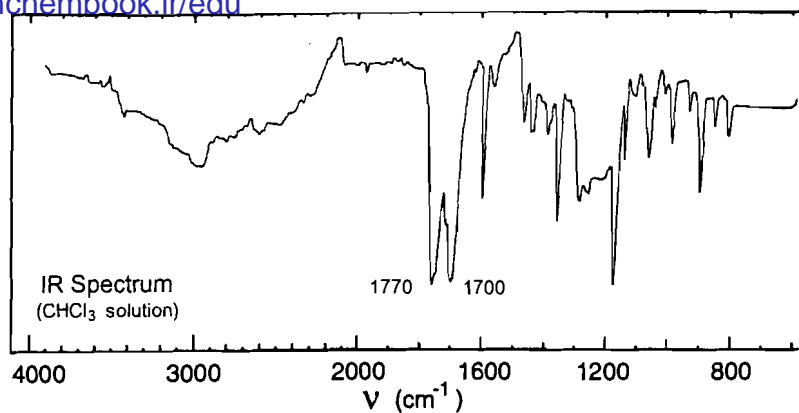

## Problem 156

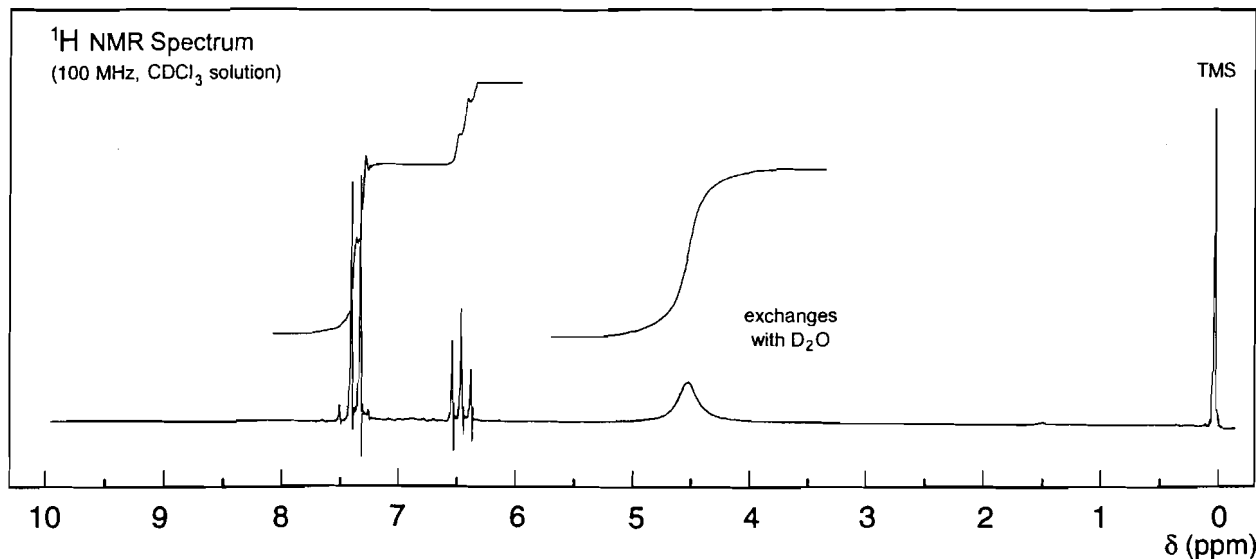
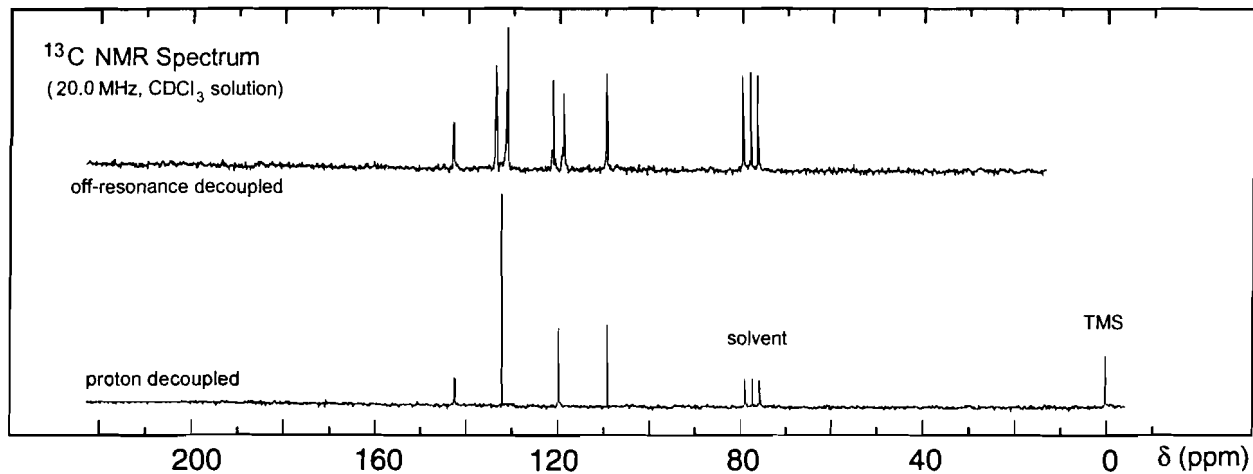
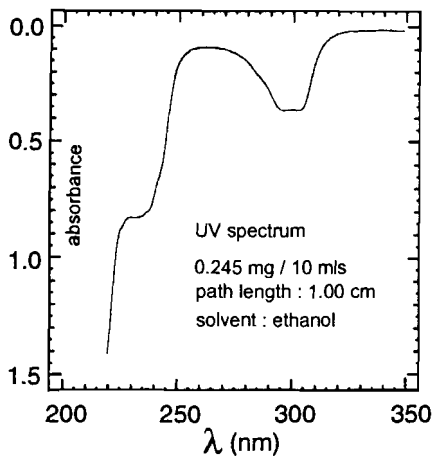
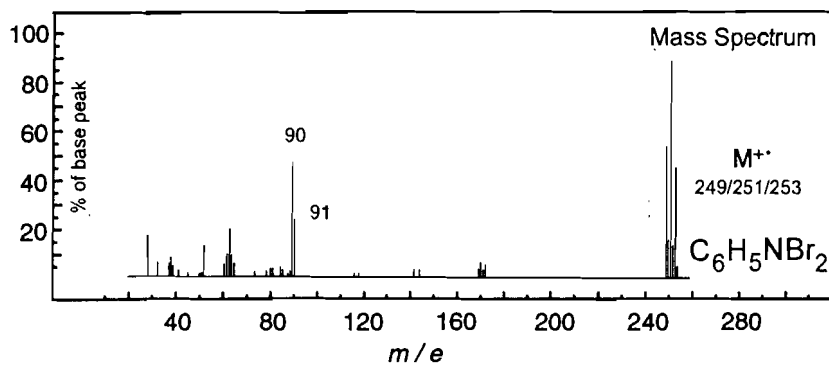
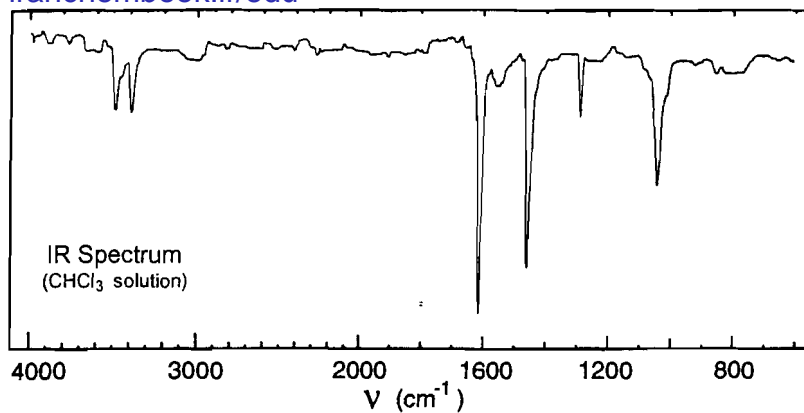

## Problem 157

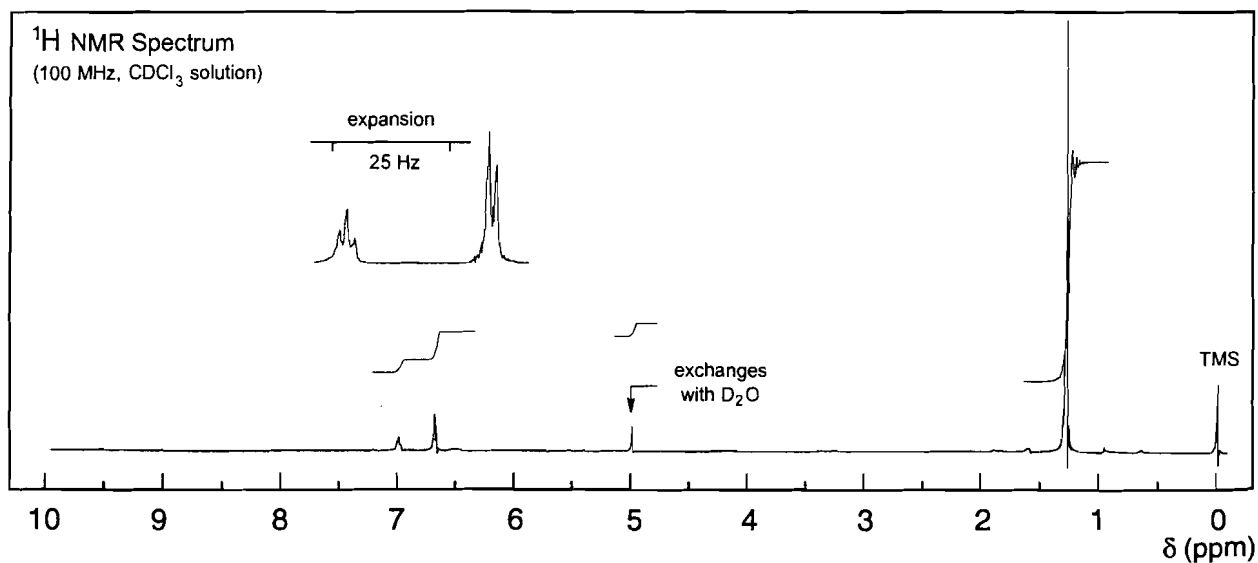
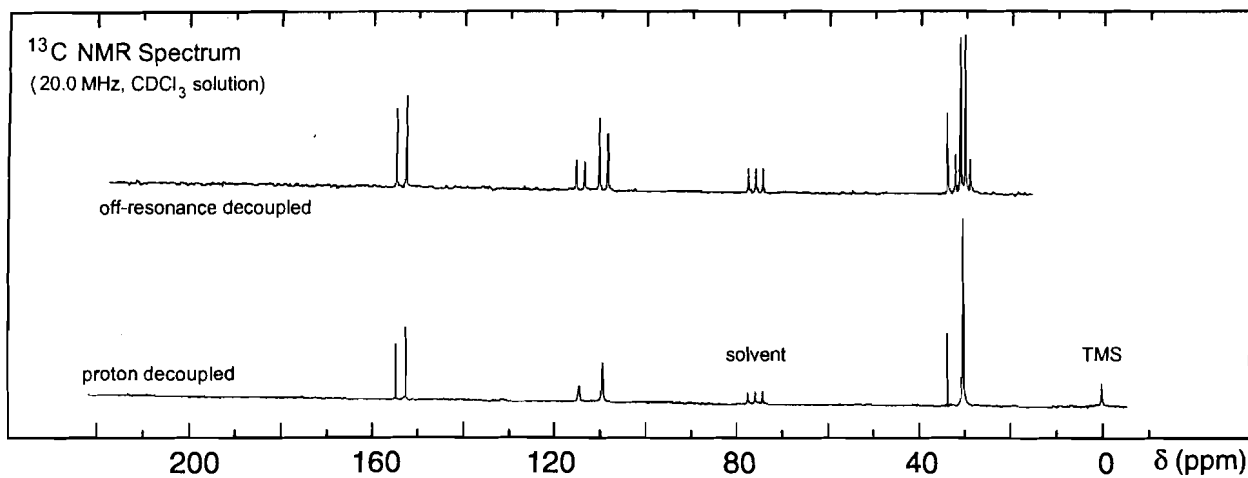
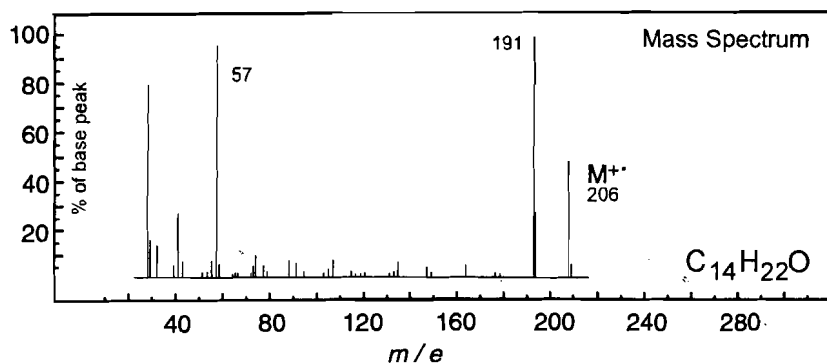
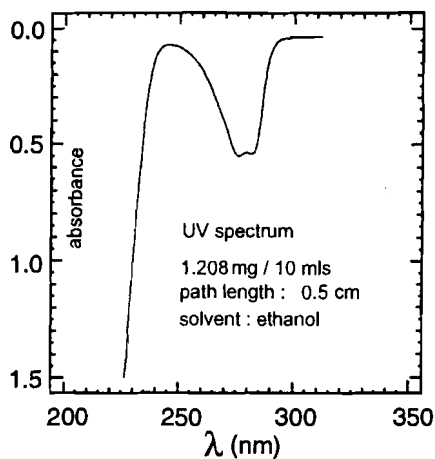
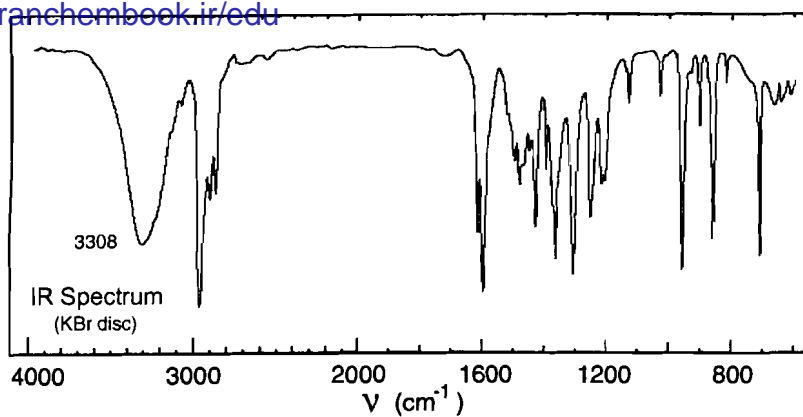

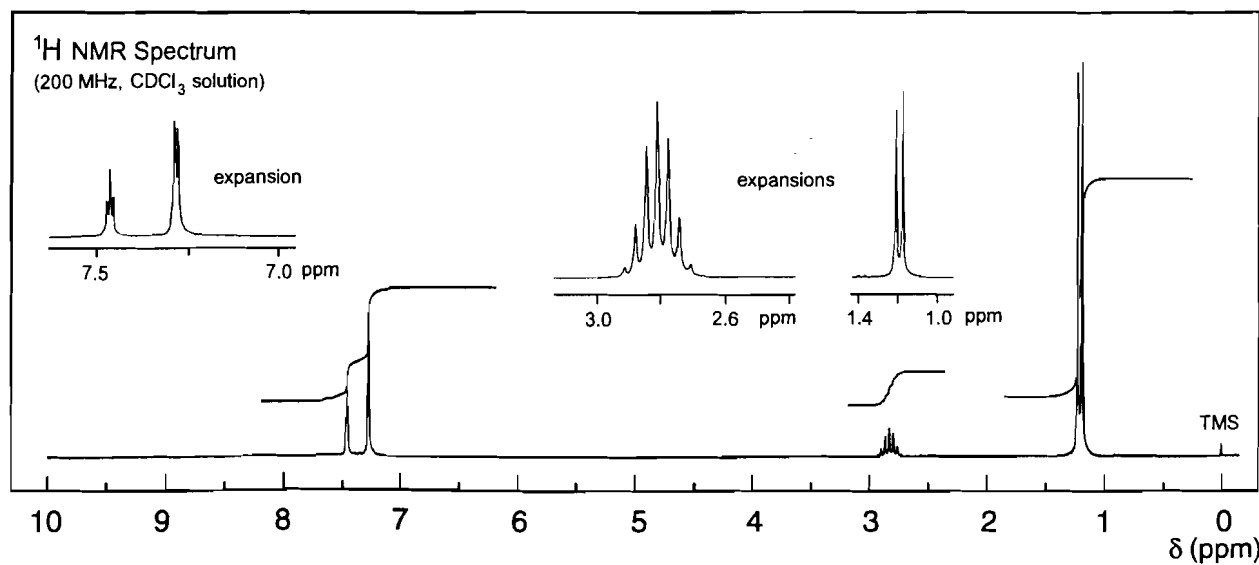
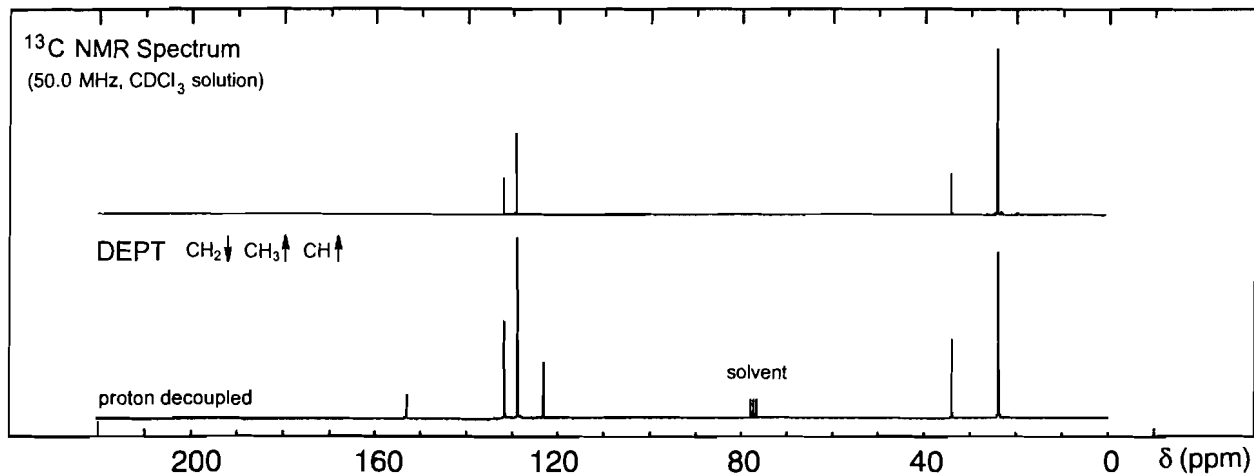
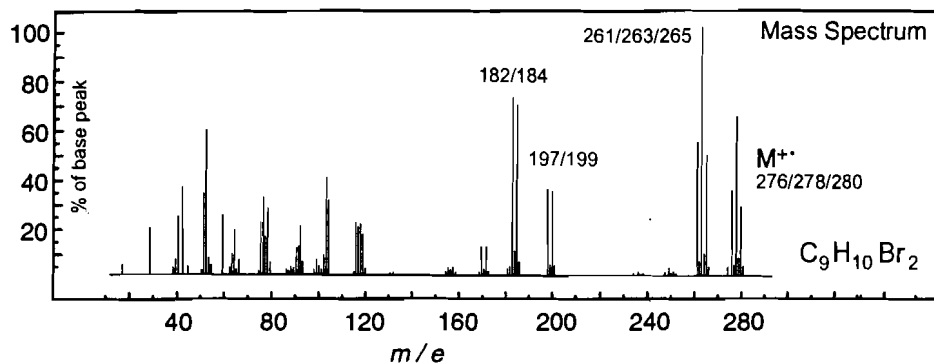
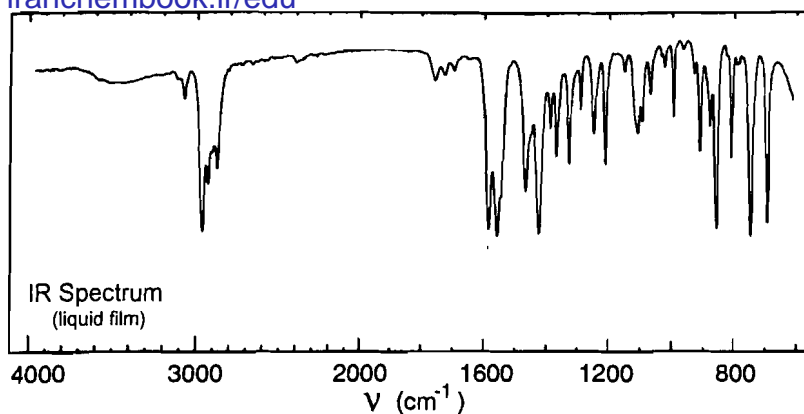



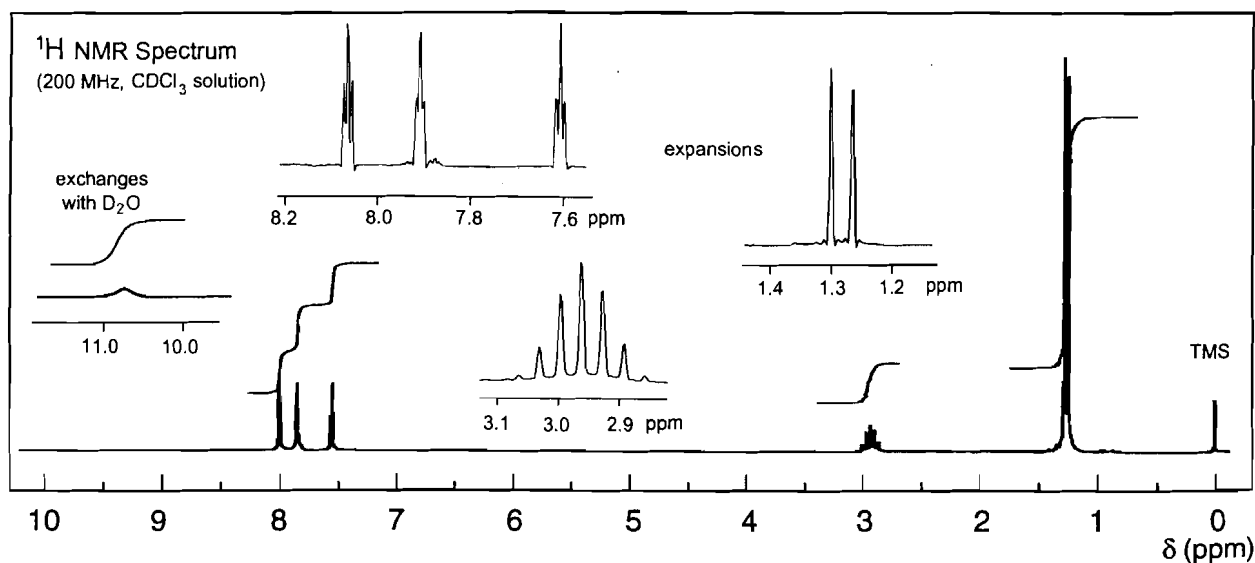
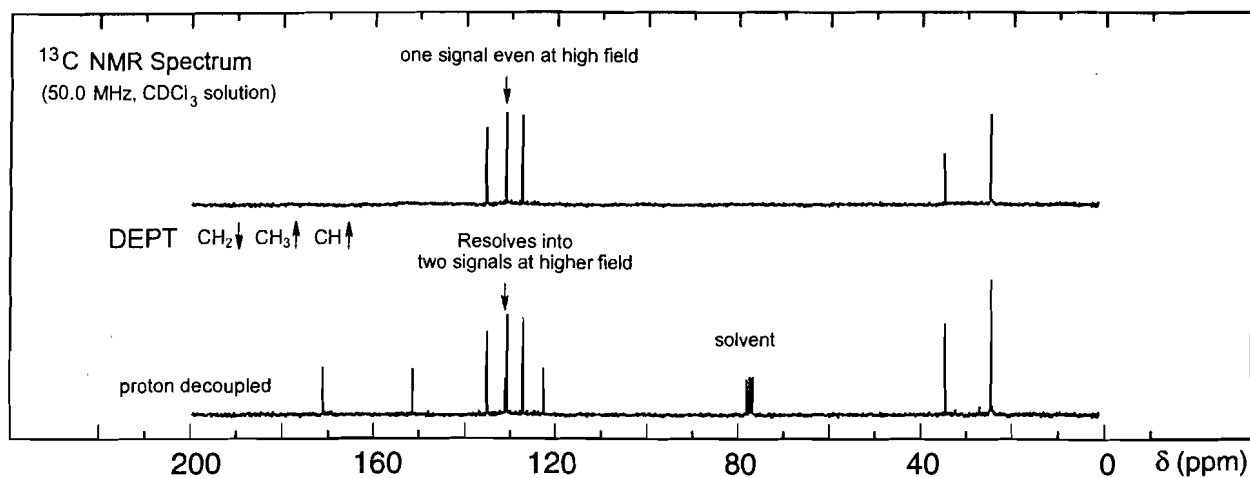
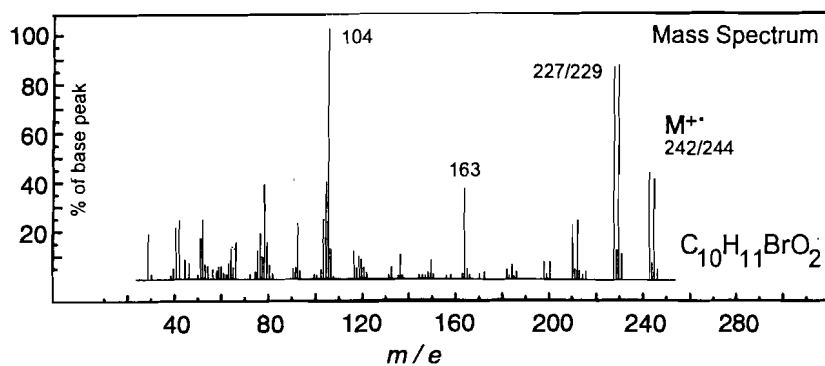
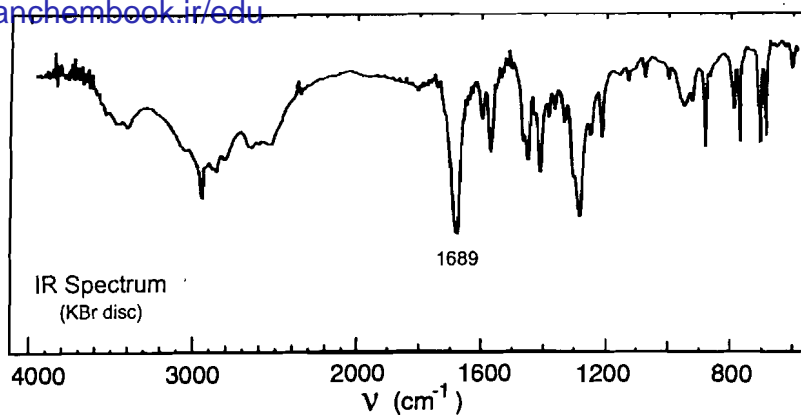

## Problem 160

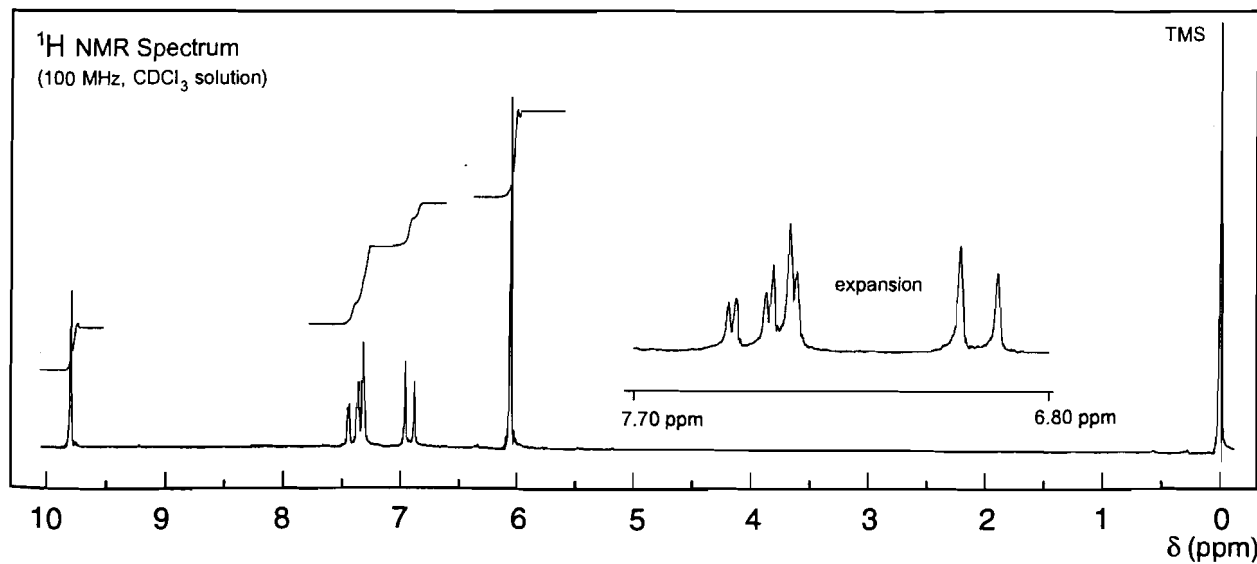
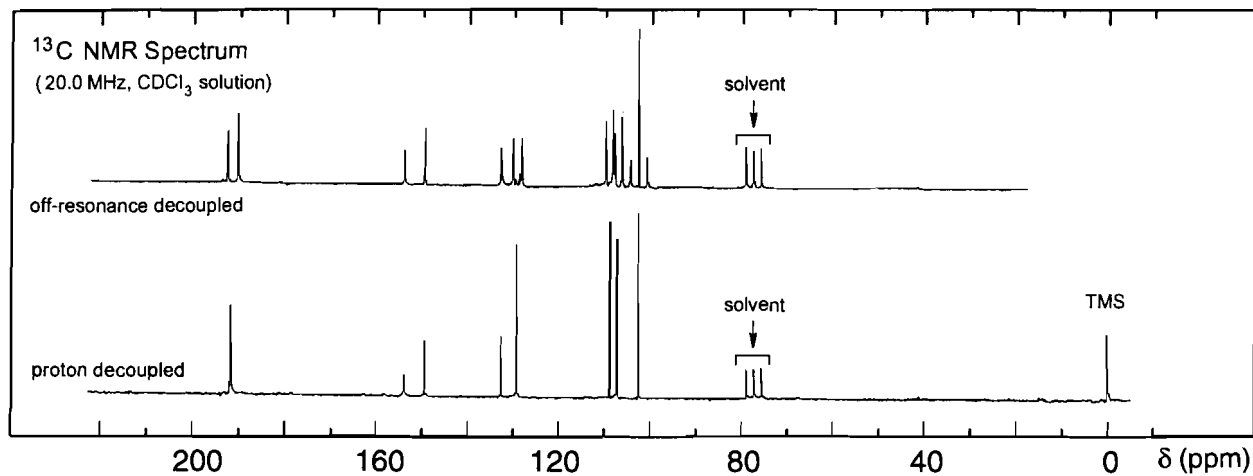
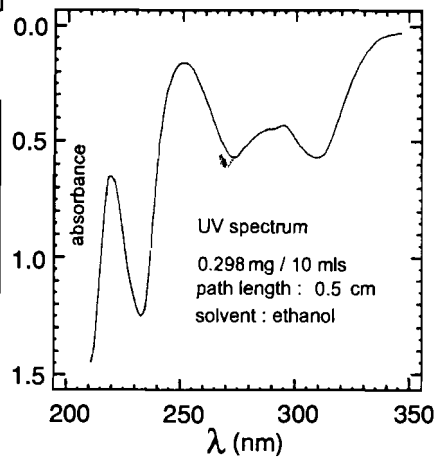
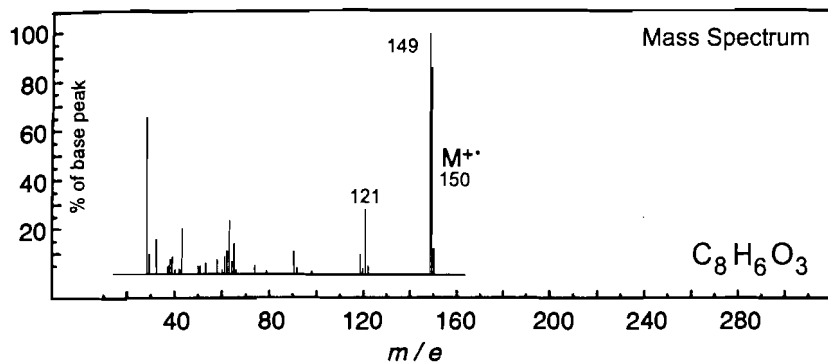
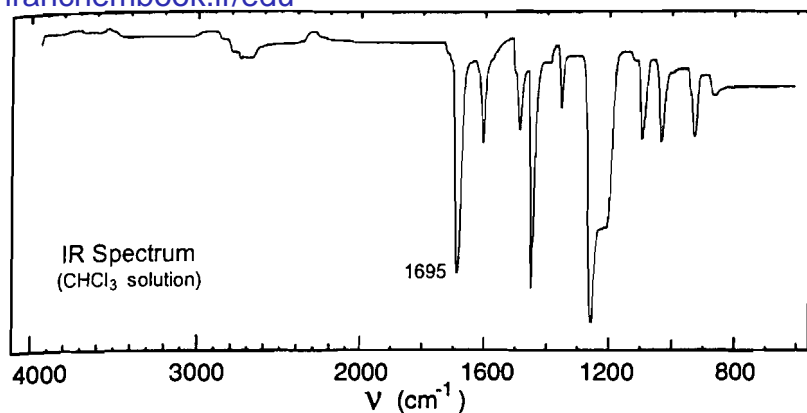

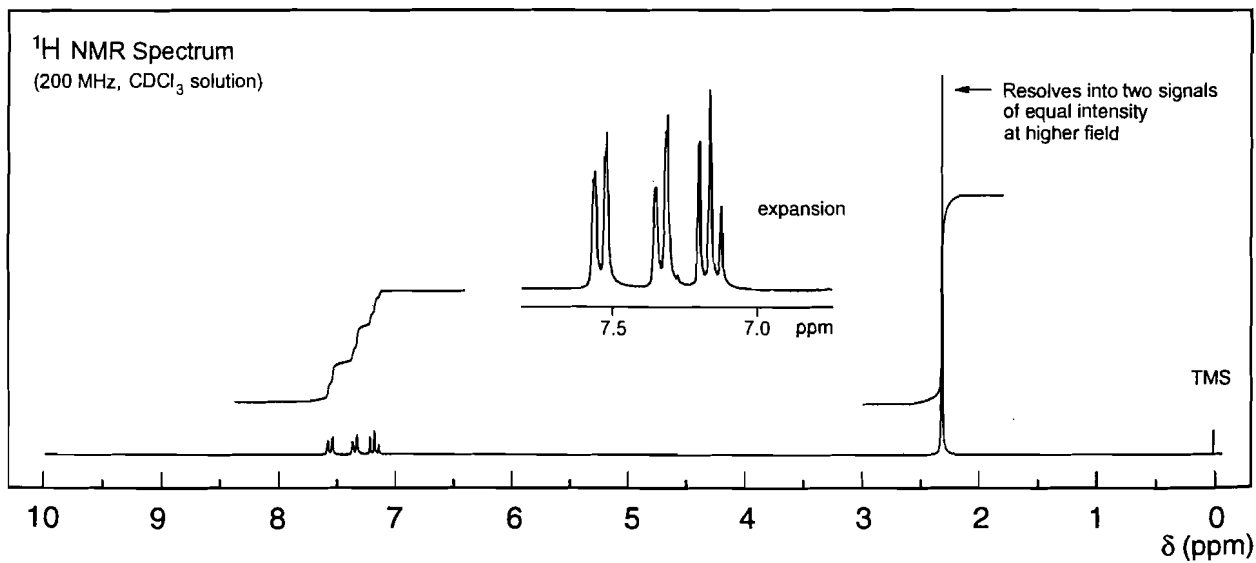
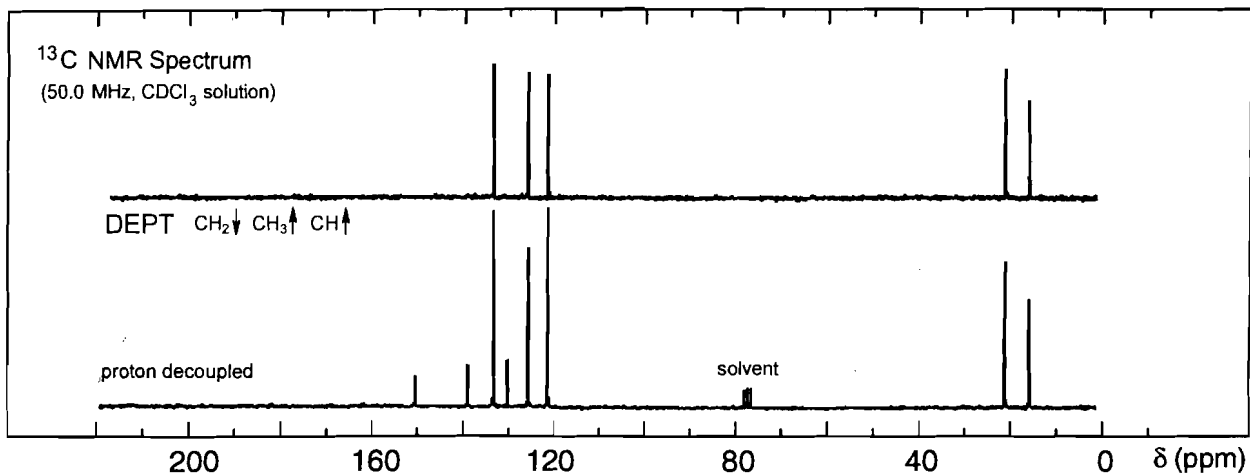
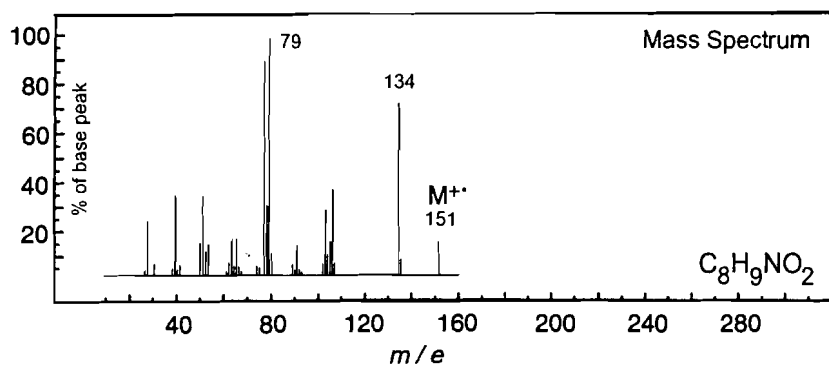
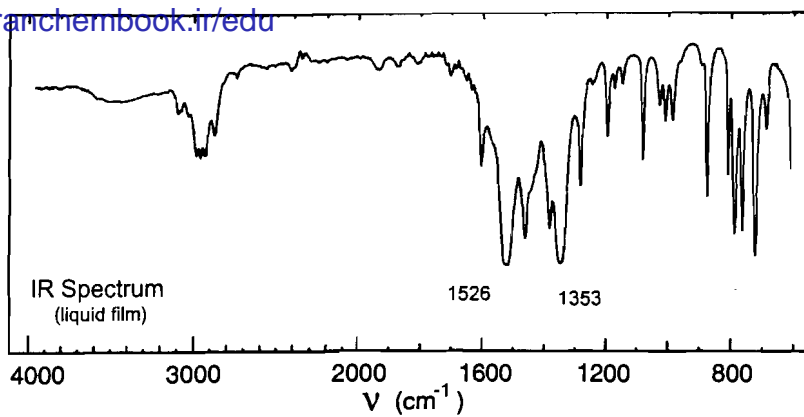

## Problem 162

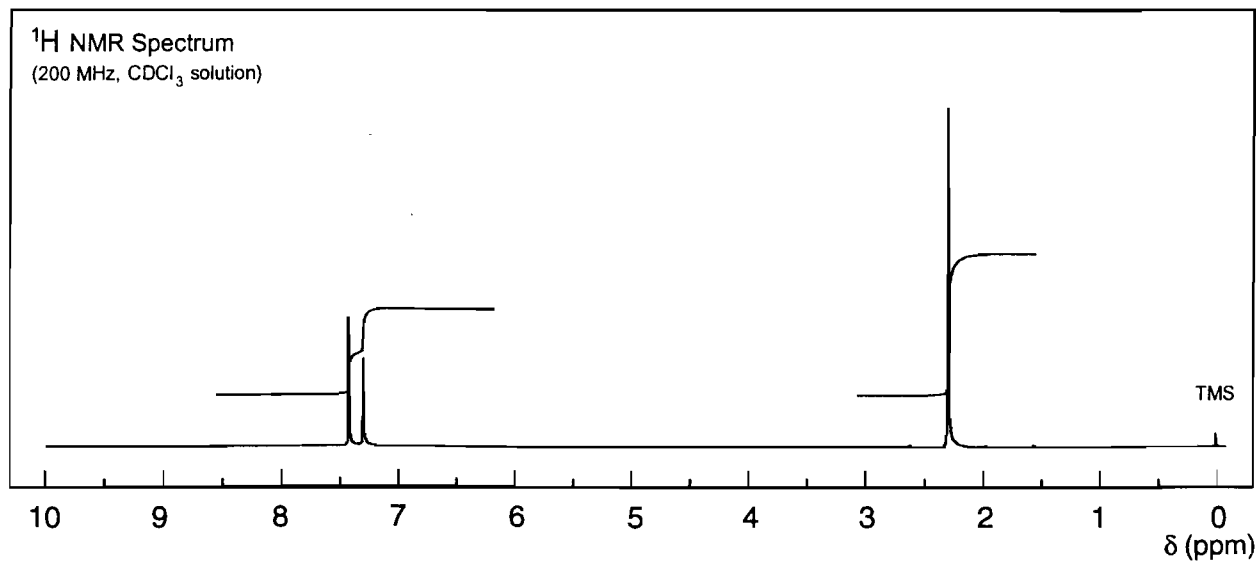
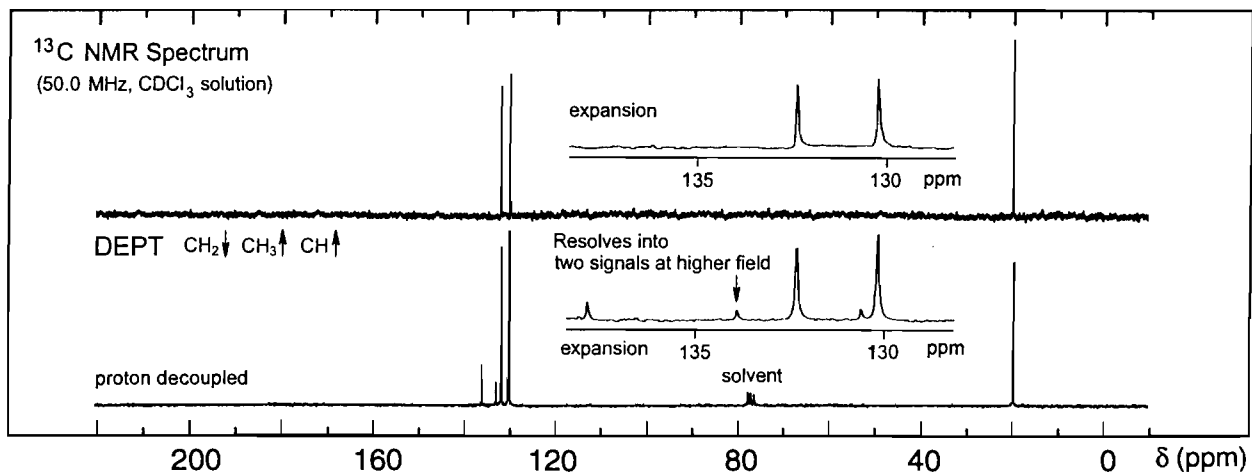
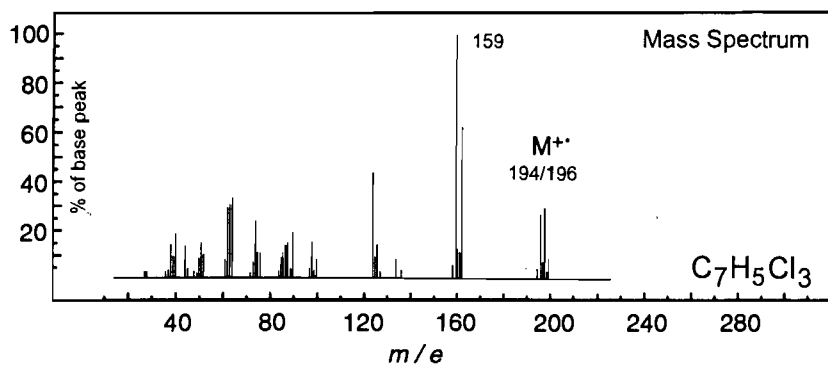
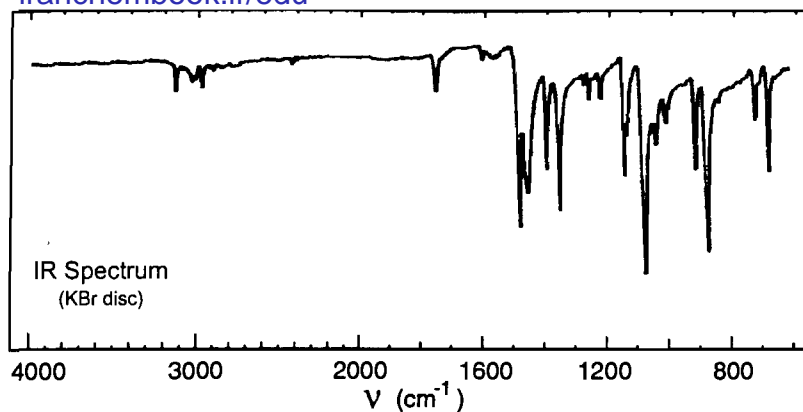

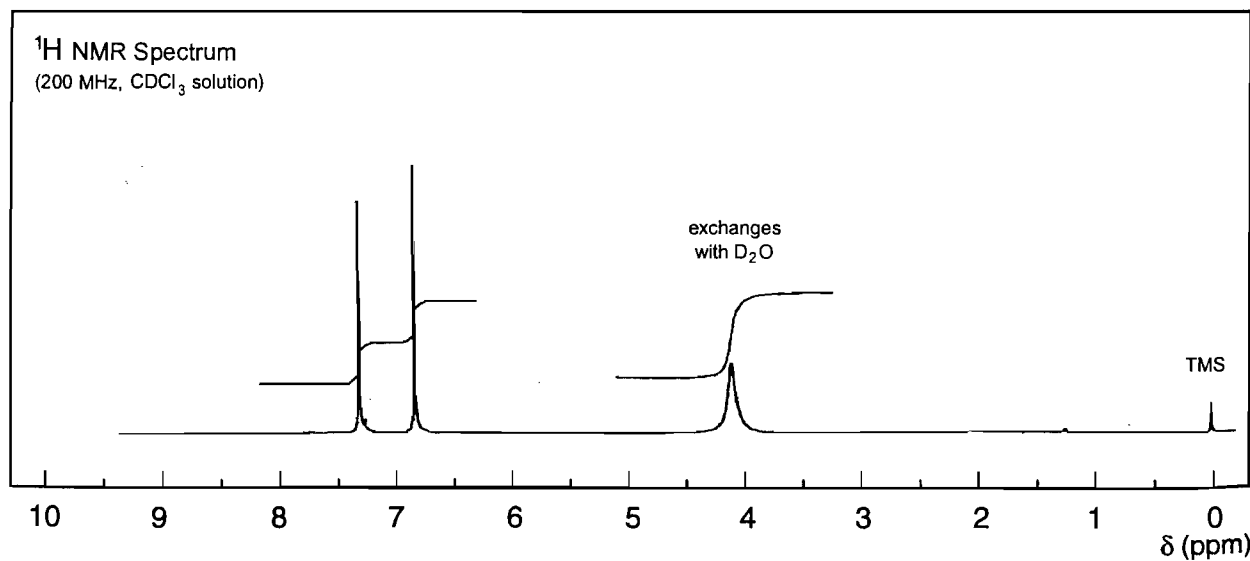
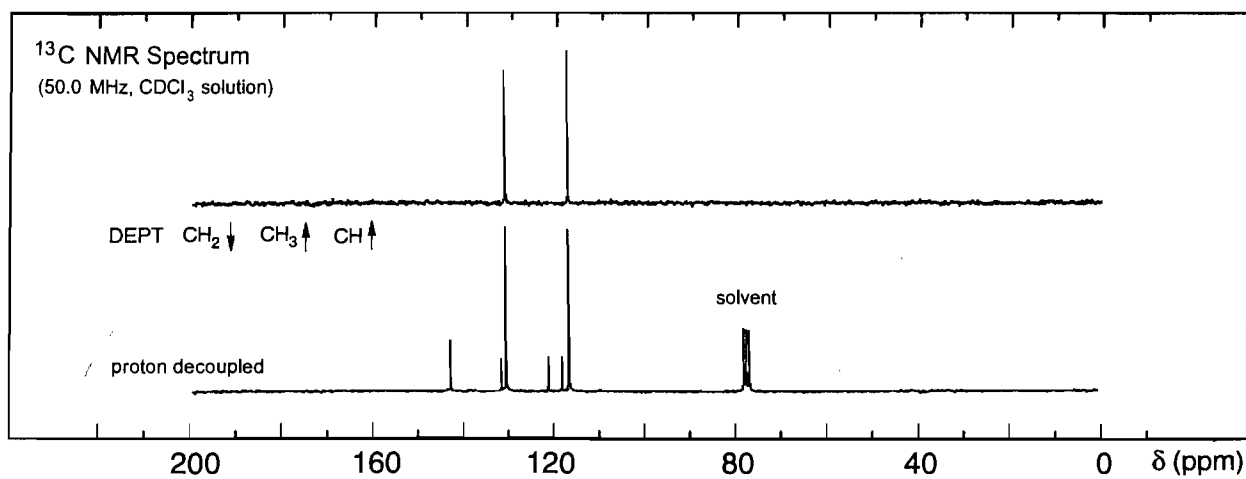
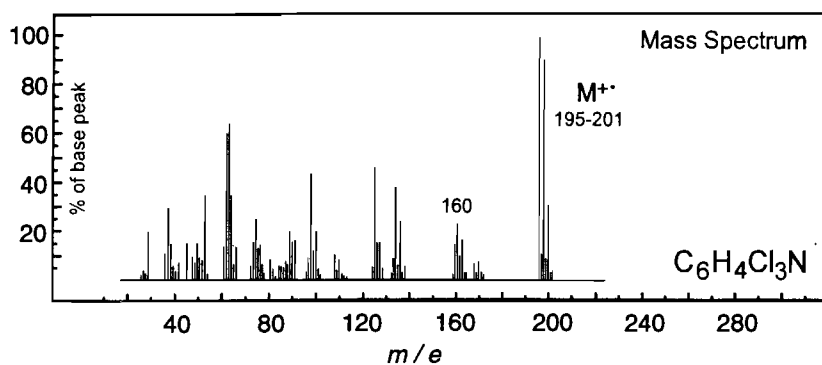
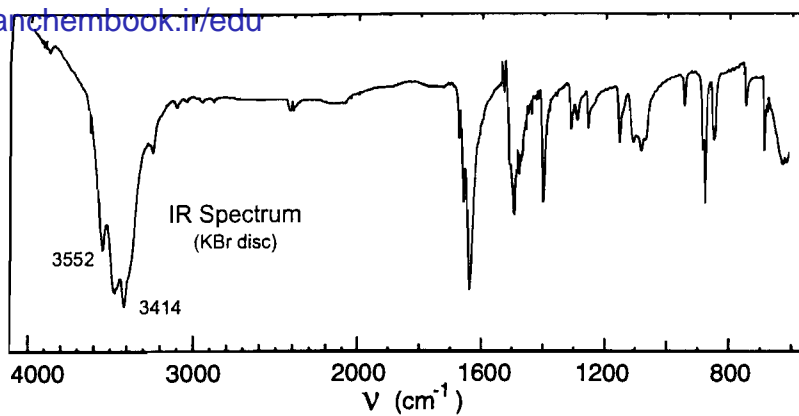

## Problem 164

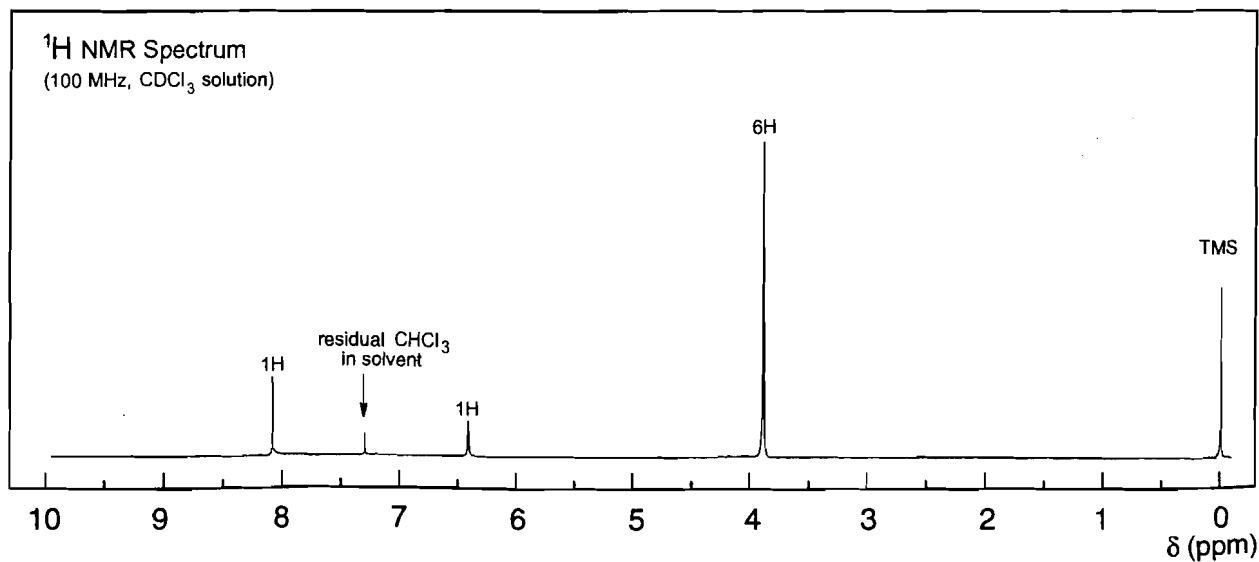
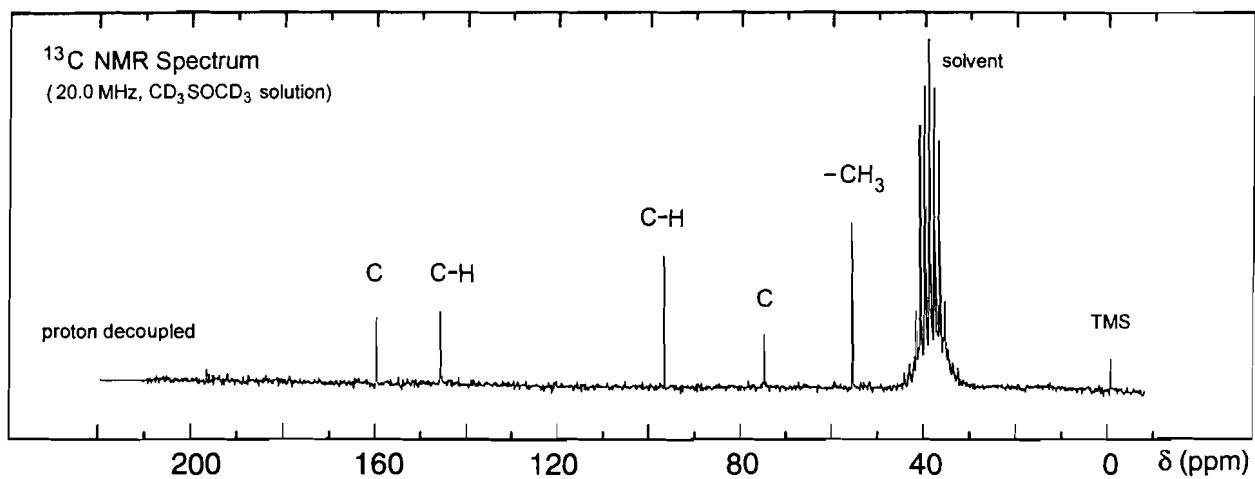
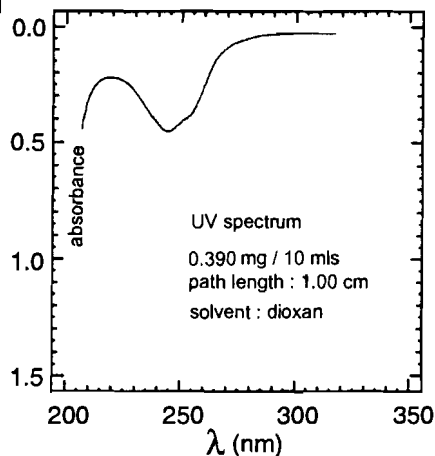
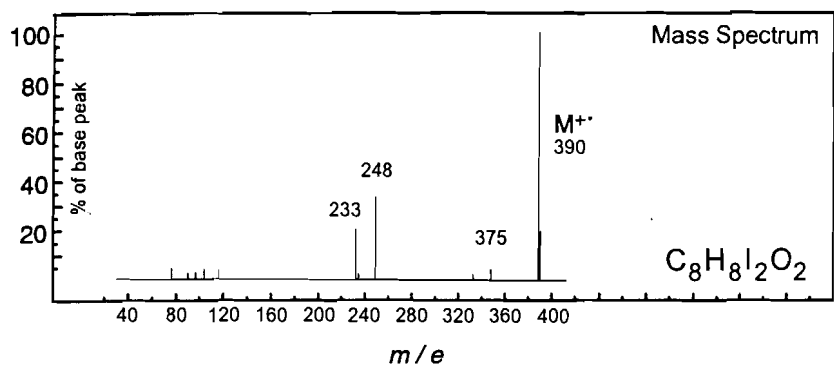
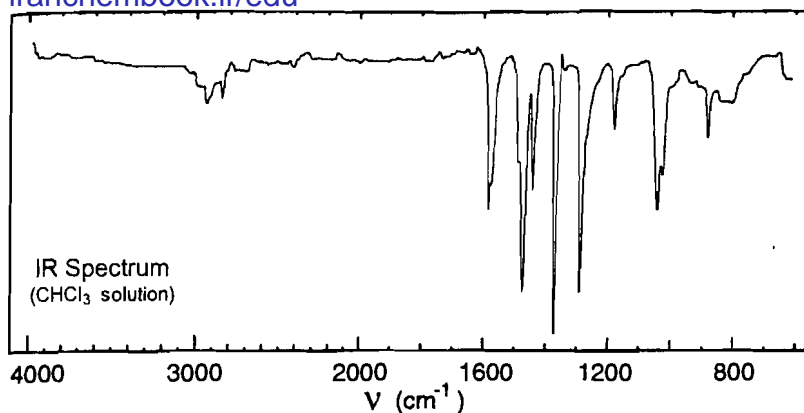

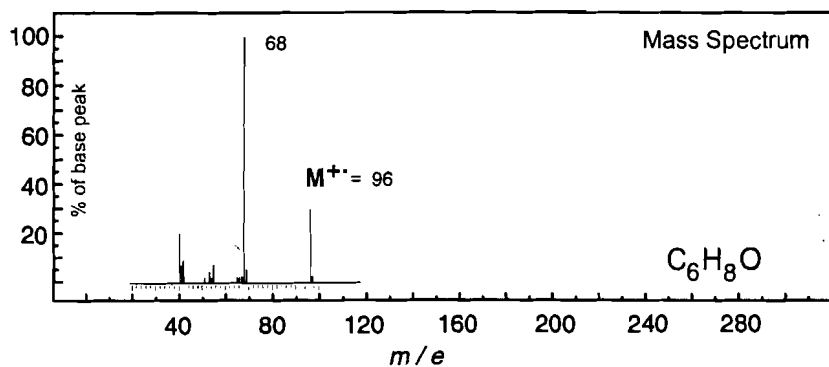
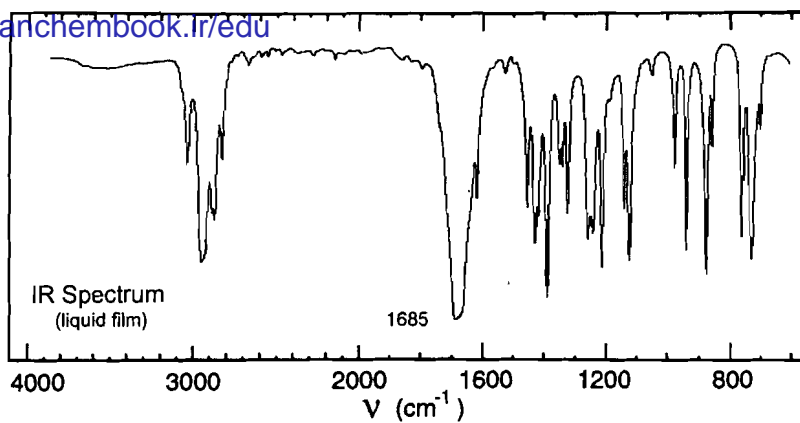

UV Spectrum

 $\lambda_{\text{max}}$  225 nm ( $\log_{10} \epsilon$  3.9)

solvent: methanol

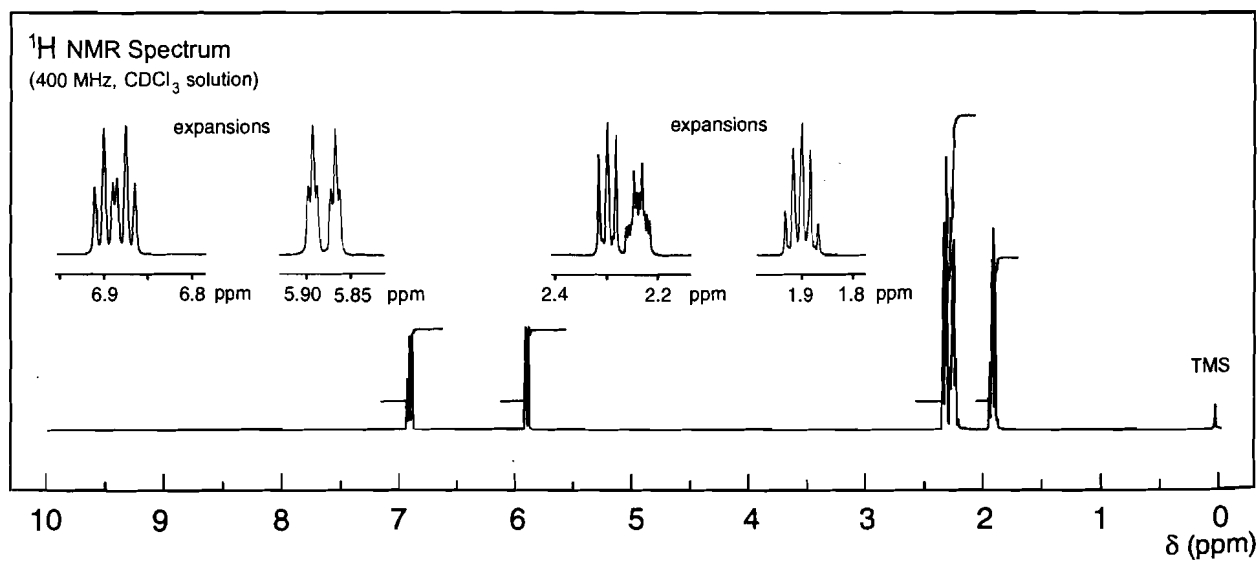
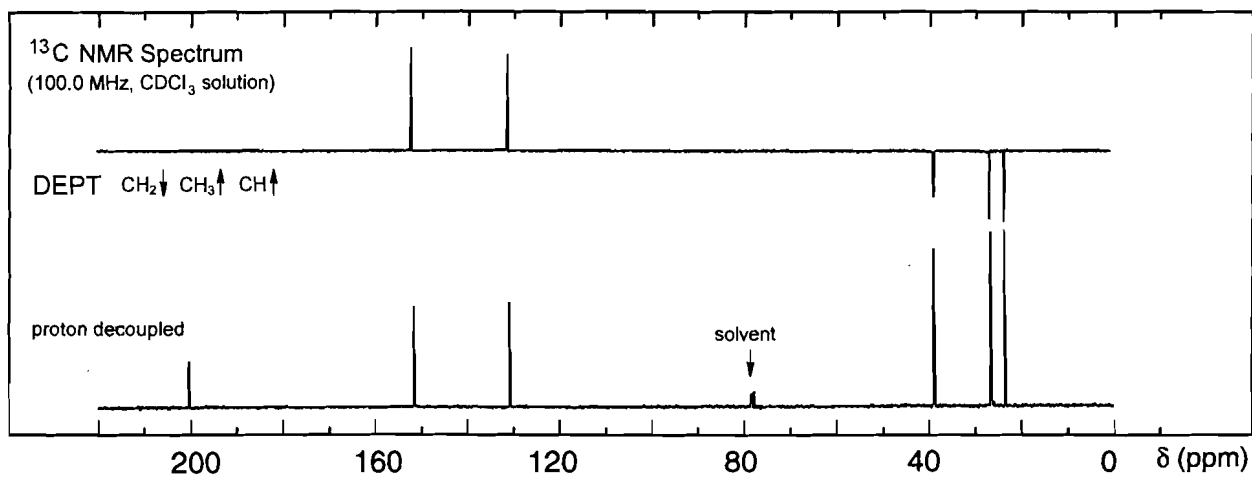

## Problem 166

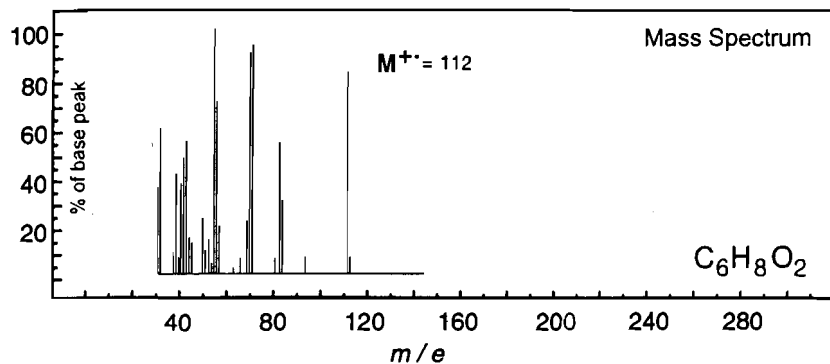
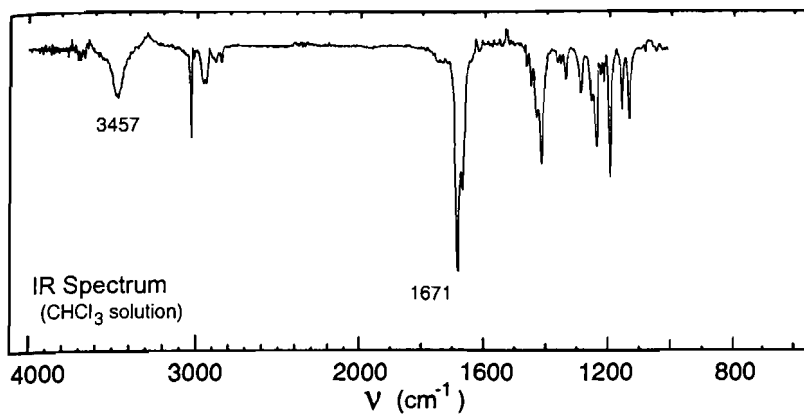

UV Spectrum

 $\lambda_{\max}$  263 nm ( $\log_{10} \epsilon$  3.9) $\lambda_{\max}$  305 nm ( $\log_{10} \epsilon$  2.1)

solvent: hexane

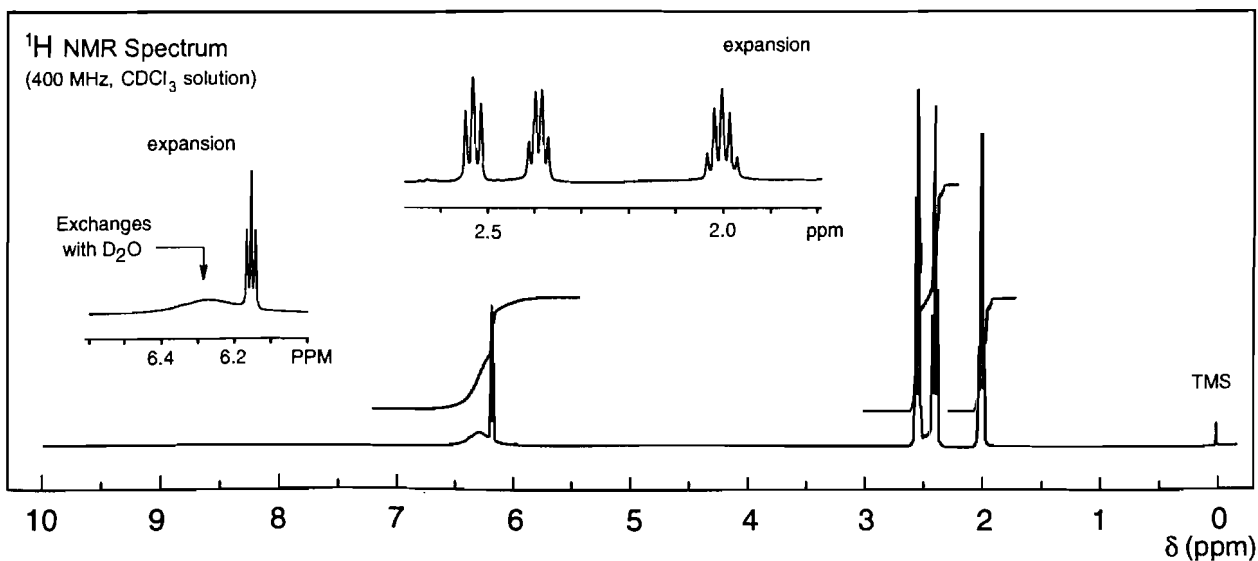
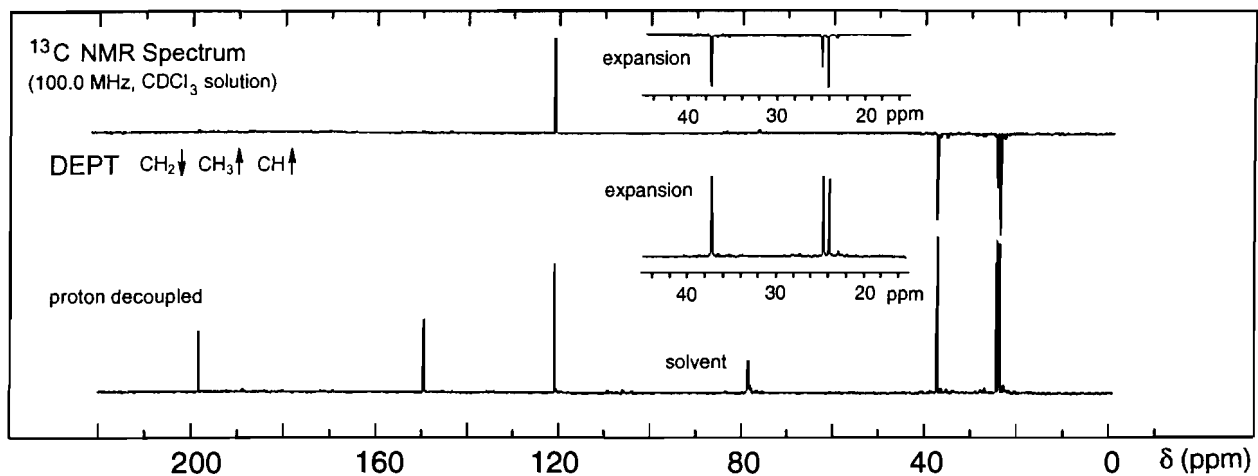



# Problem 167

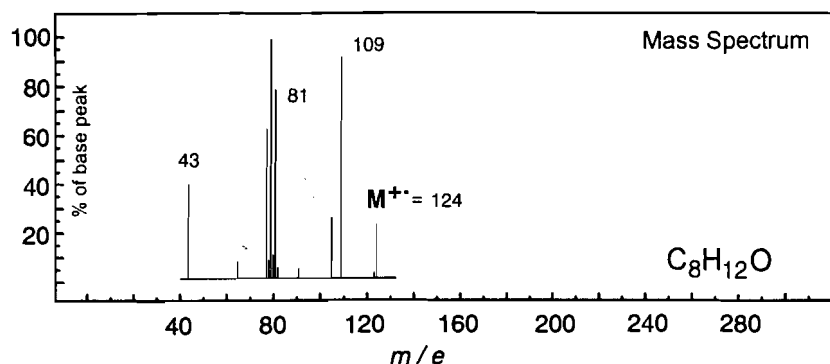
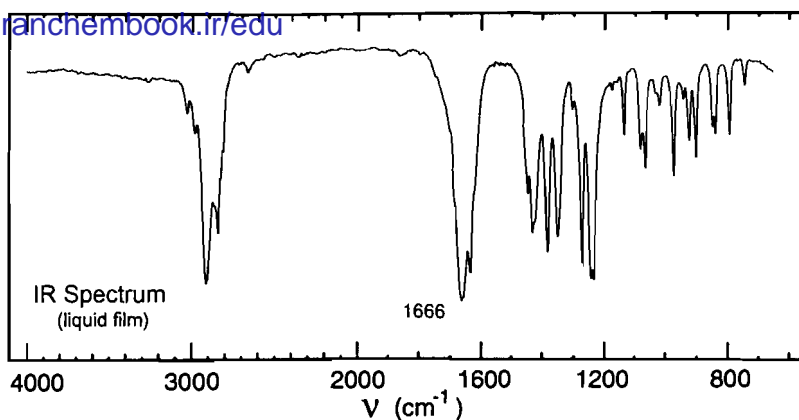

UV Spectrum

$\lambda_{\text{max}}$  234 nm ( $\log_{10} \epsilon$  4.1)

solvent: ethanol

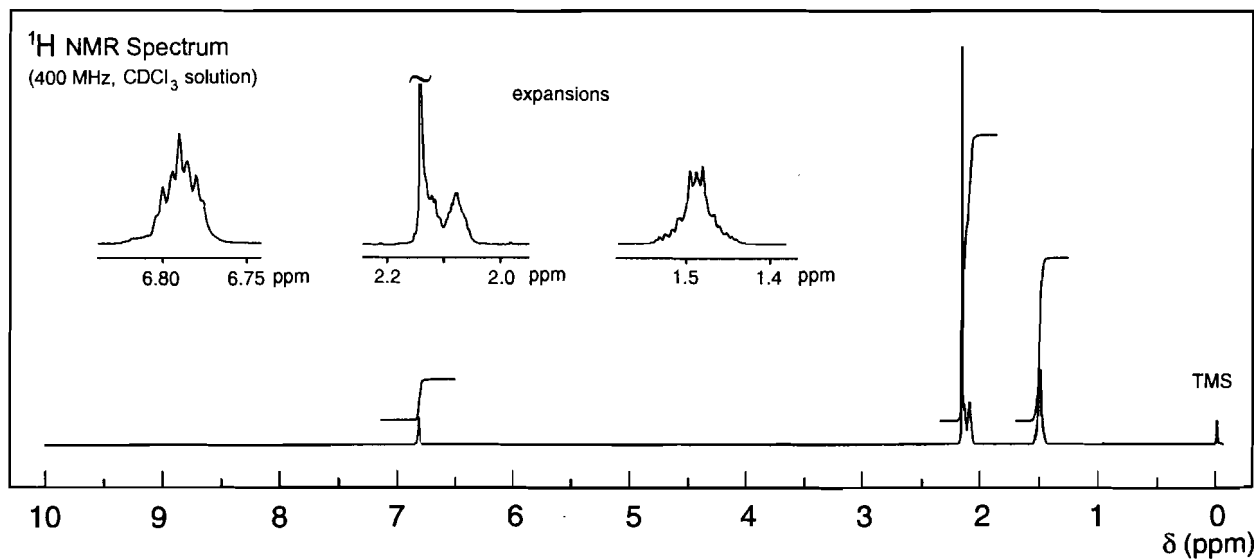
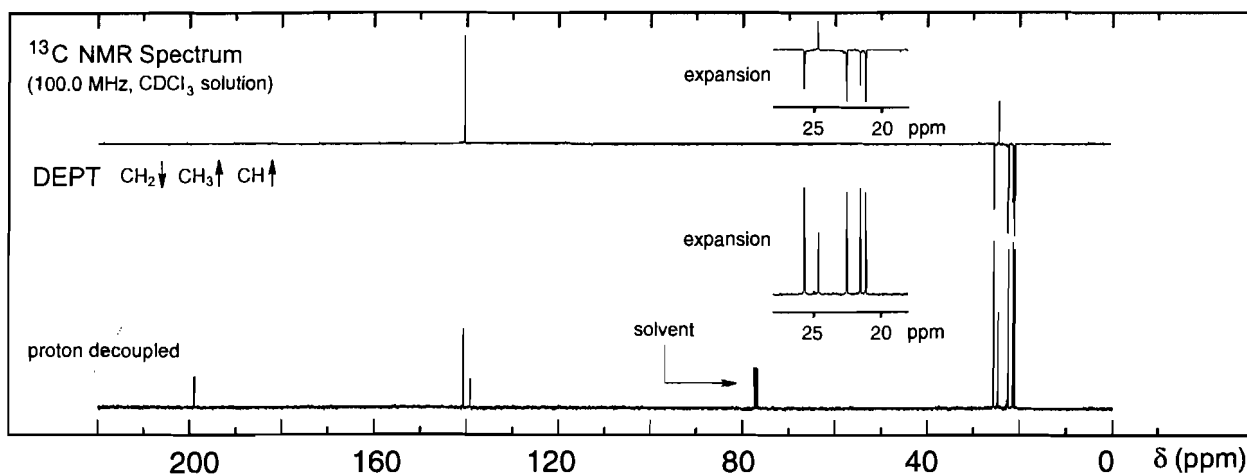

## Problem 168

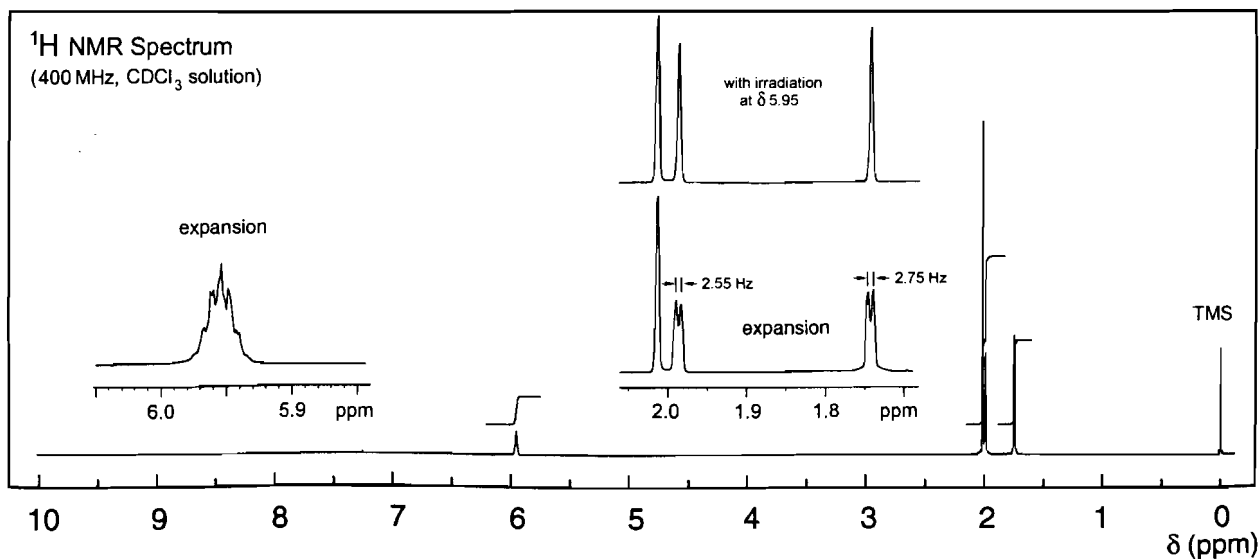
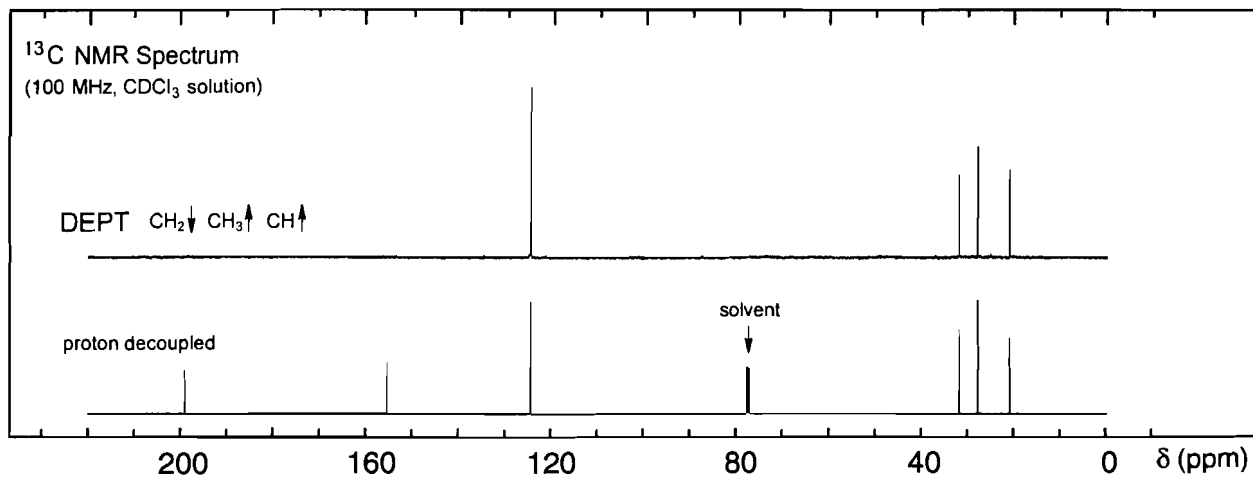
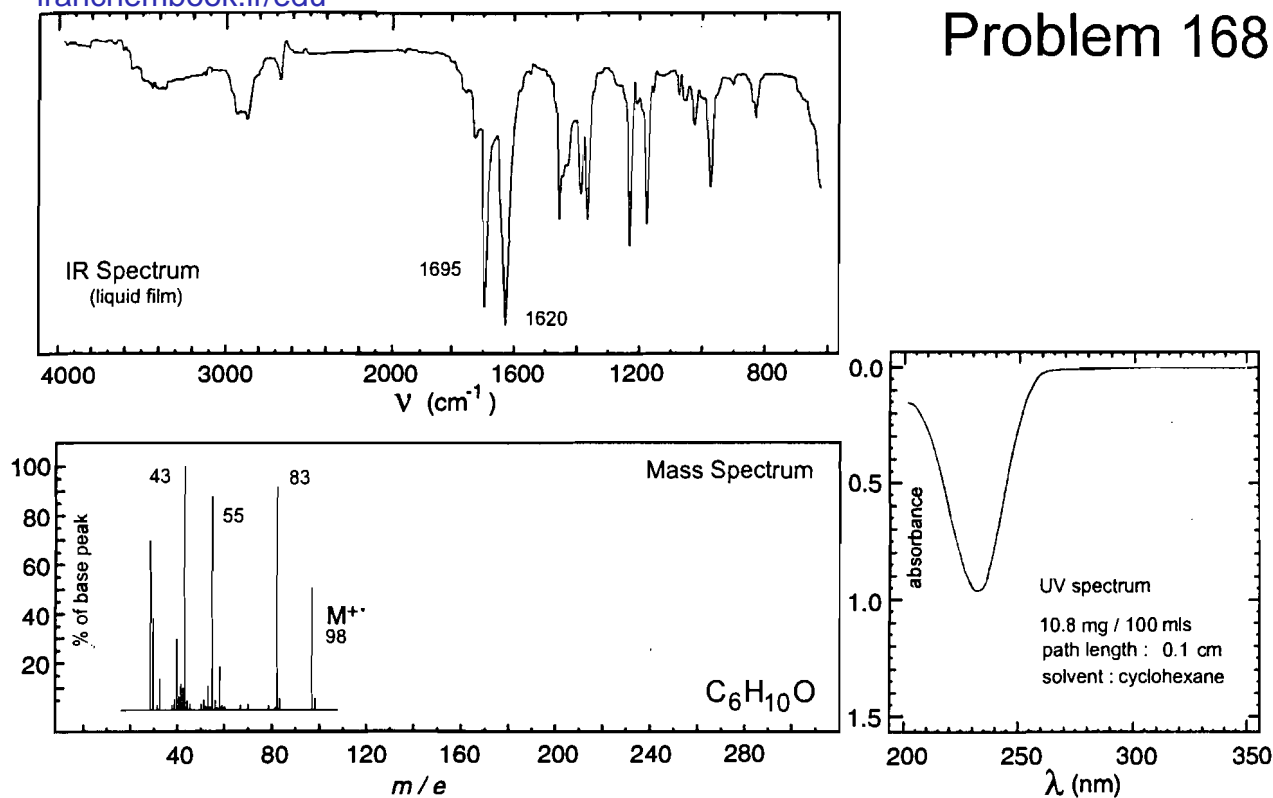

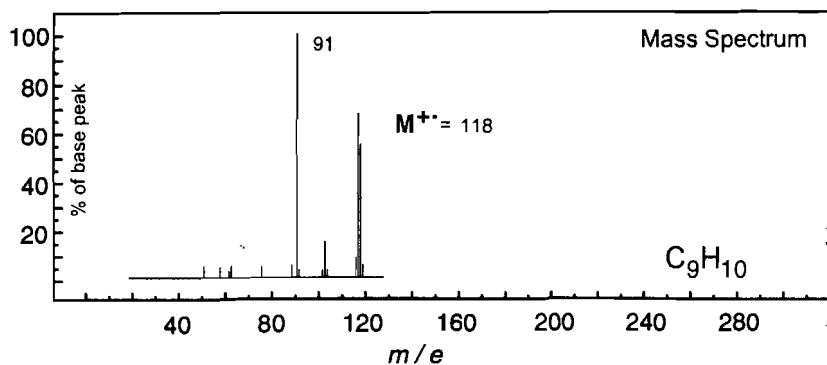
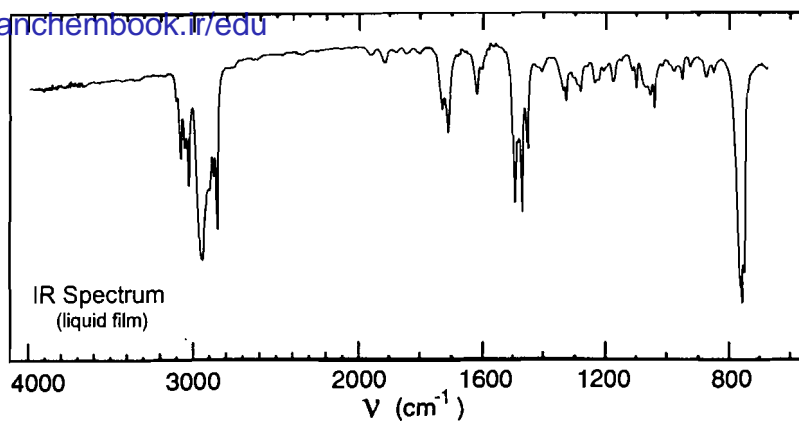

UV Spectrum

 $\lambda_{\max}$  260 nm ( $\log_{10} \epsilon$  2.9) $\lambda_{\max}$  266 nm ( $\log_{10} \epsilon$  3.1) $\lambda_{\max}$  272 nm ( $\log_{10} \epsilon$  3.1)

solvent: methanol

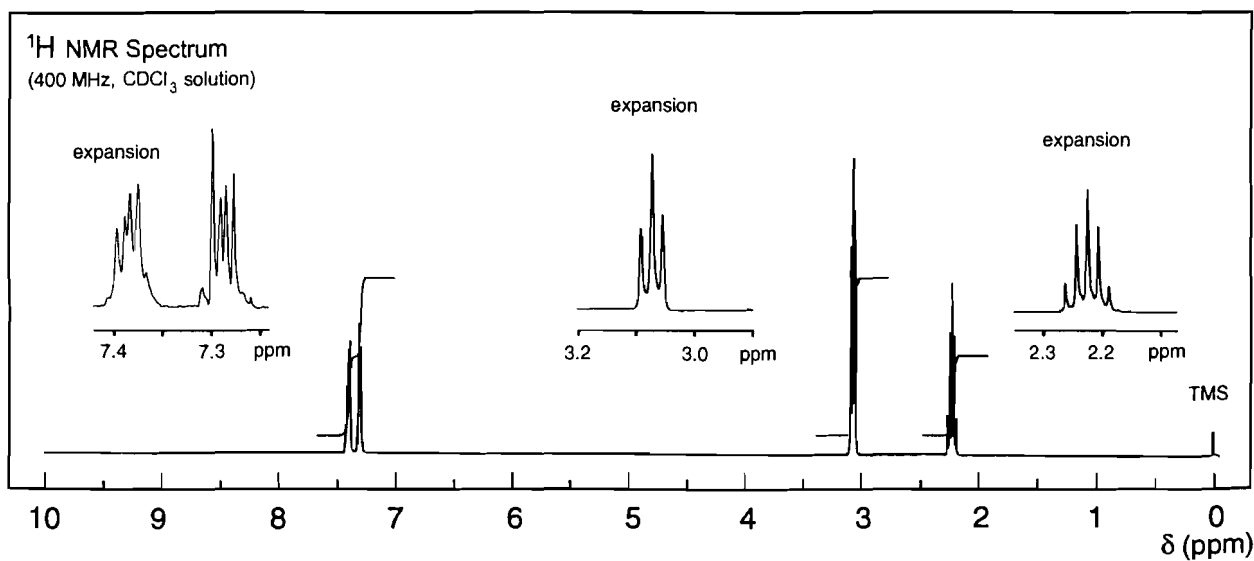
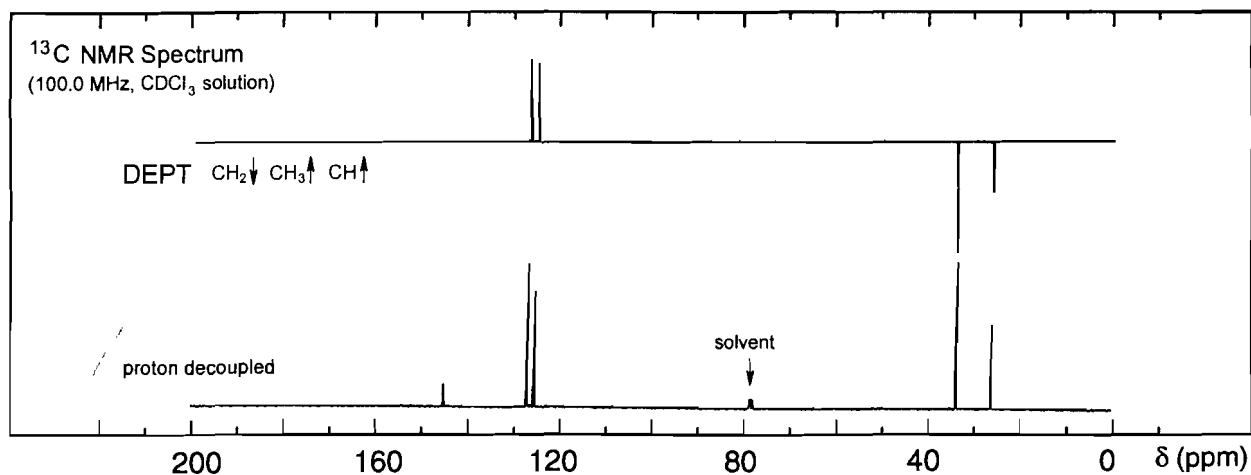

## Problem 170

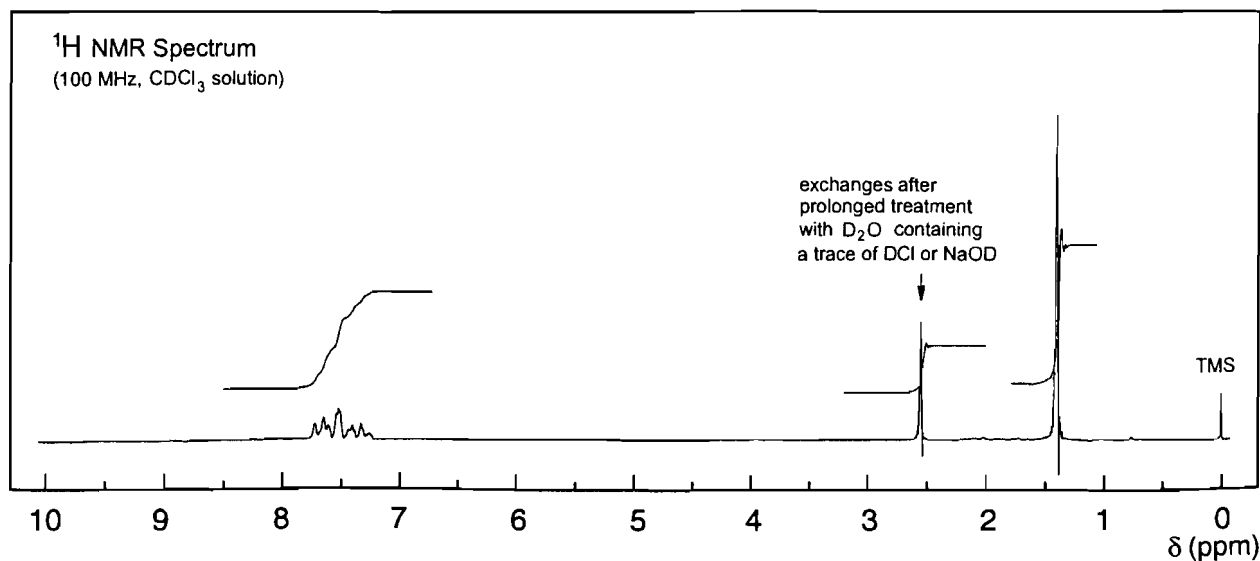
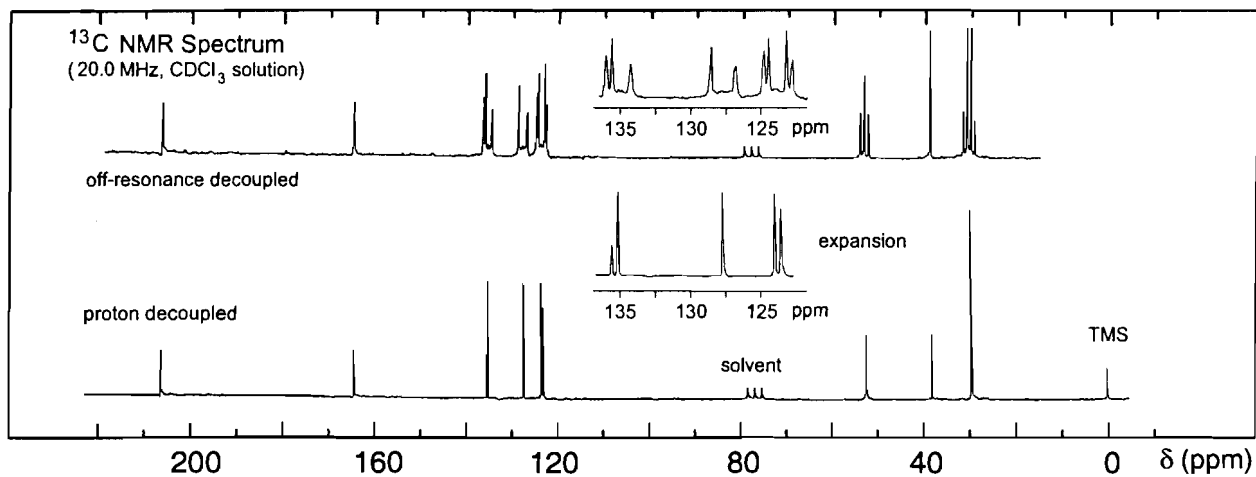
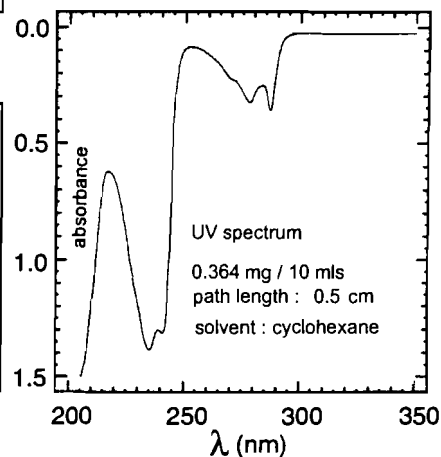
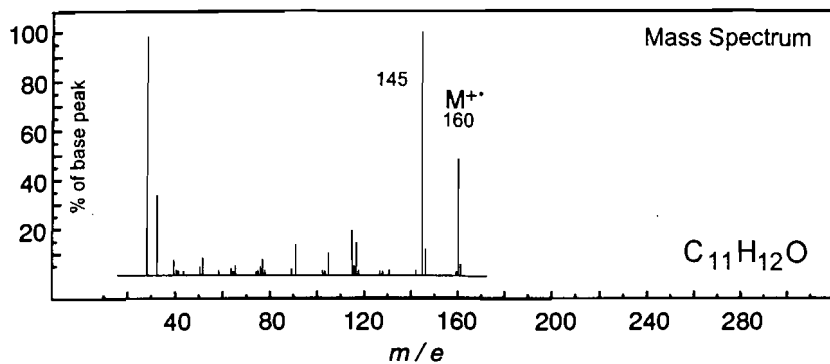
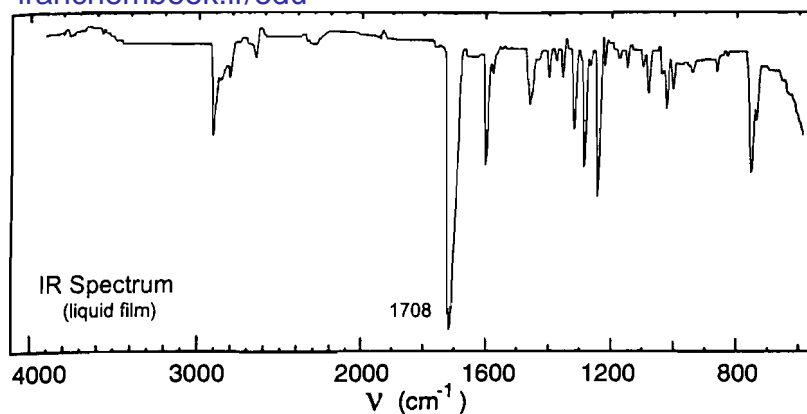

# Problem 171

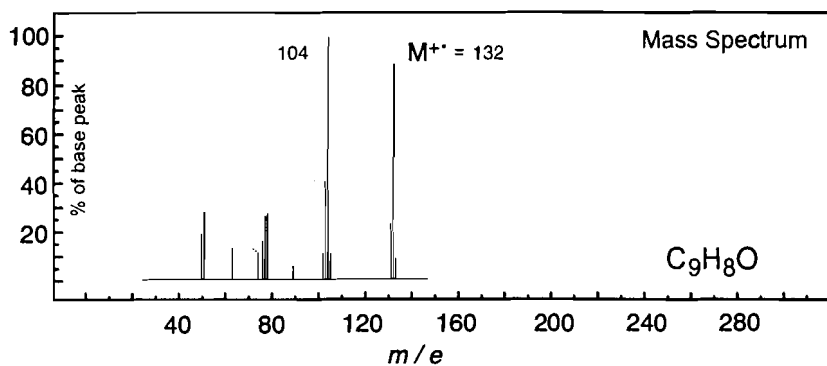
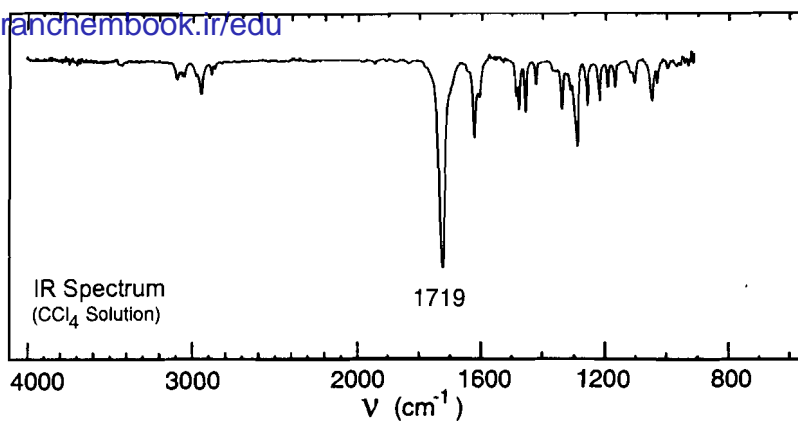

UV Spectrum

$$\lambda_{\max} = 243 \text{ nm } (\log_{10} \epsilon \text{ 4.1})$$

$$\lambda_{\max} = 291 \text{ nm } (\log_{10} \epsilon \text{ 3.4})$$

solvent : ethanol

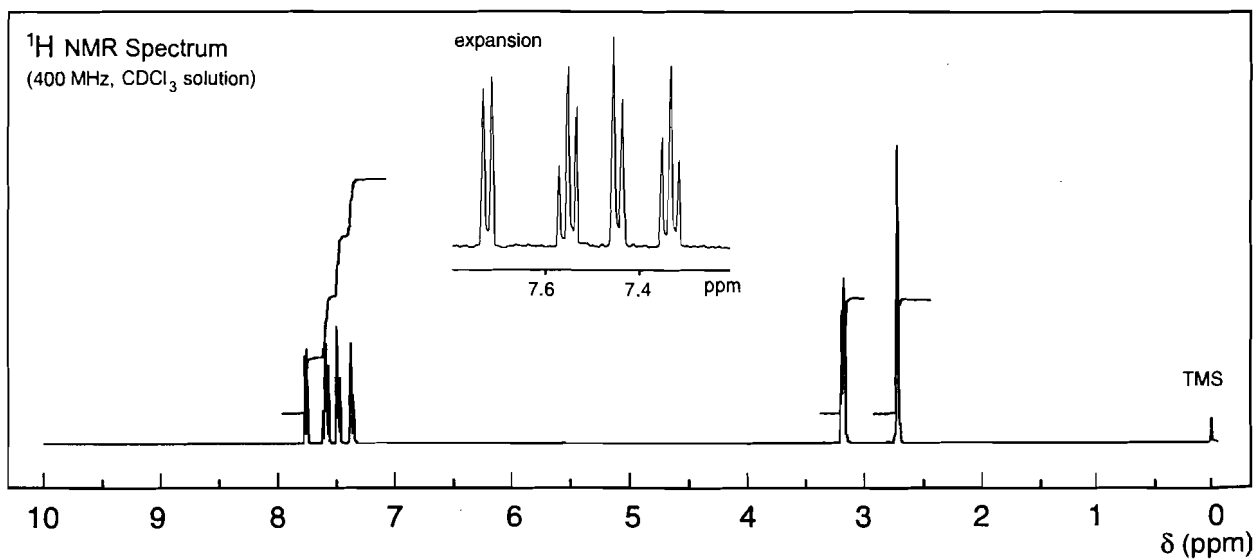
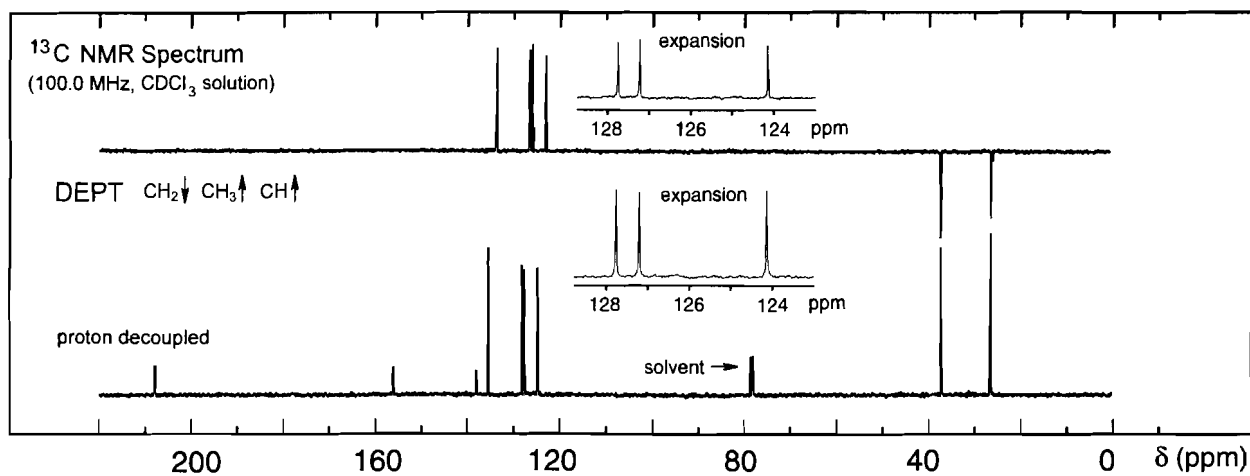

## Problem 172

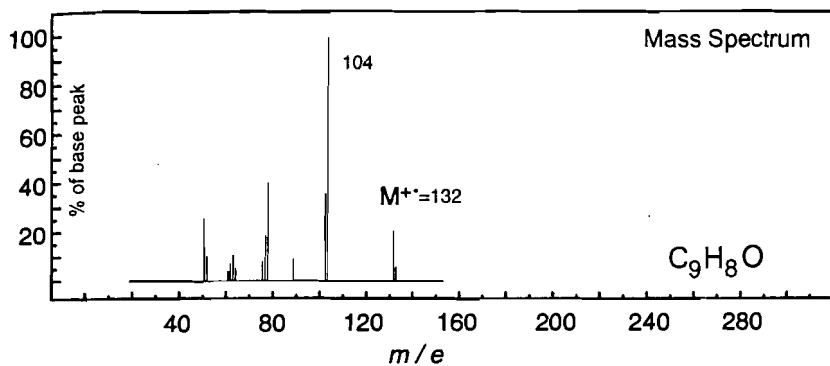
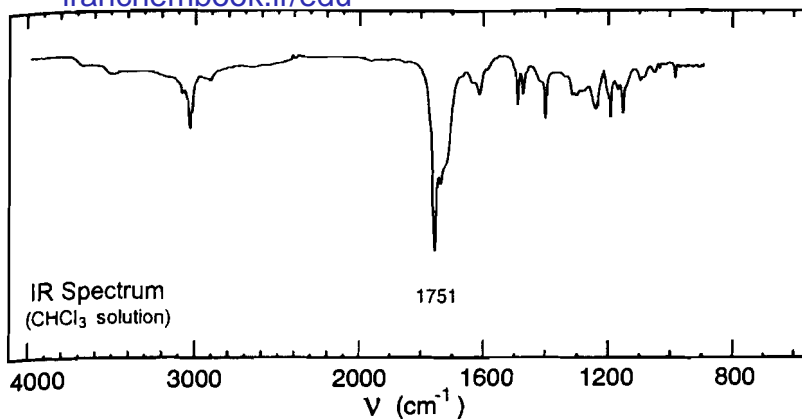

UV Spectrum

 $\lambda_{\max}$  268 nm ( $\log_{10} \epsilon$  3.1) $\lambda_{\max}$  275 nm ( $\log_{10} \epsilon$  3.1)

solvent : ethanol

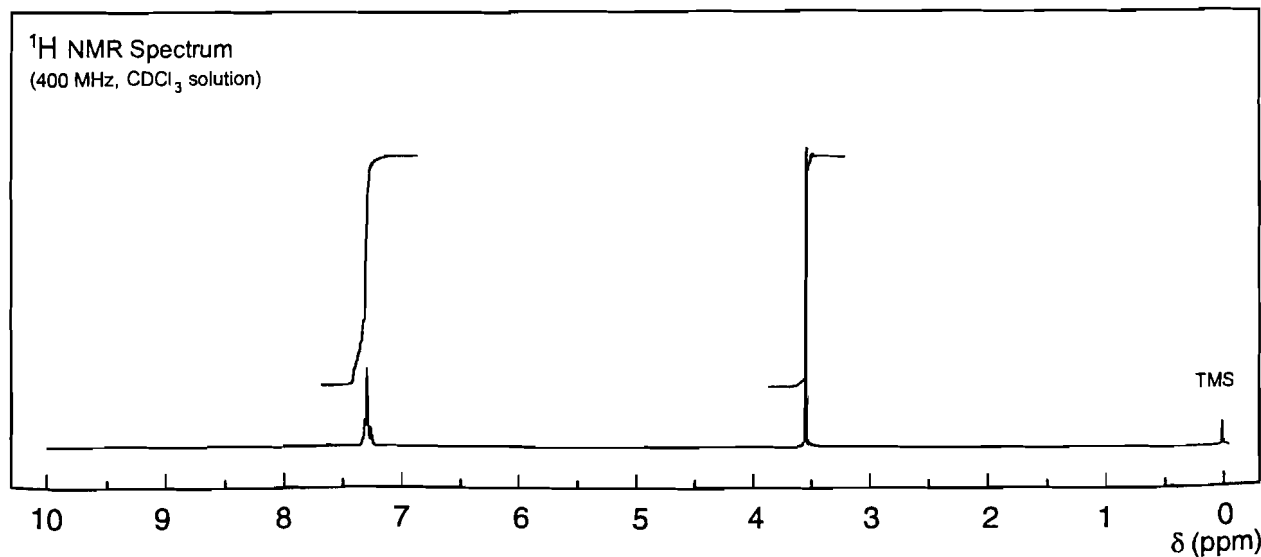
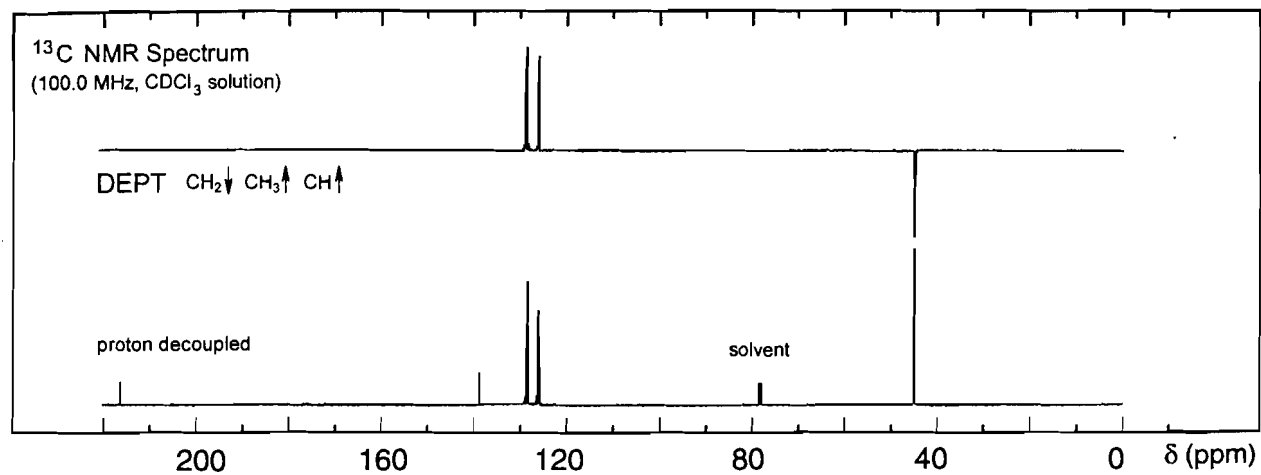

## Problem 173

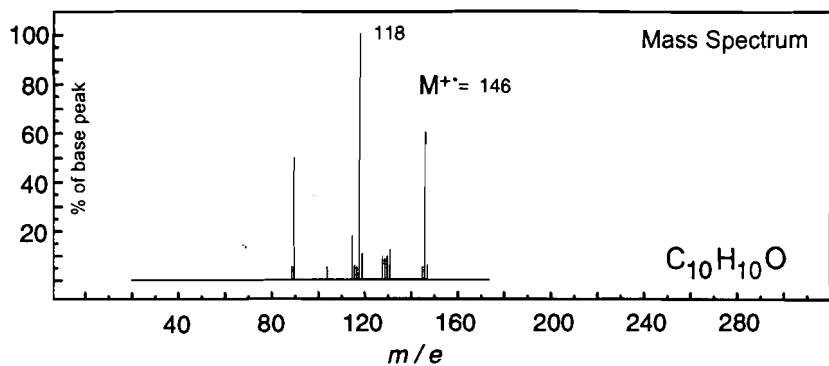
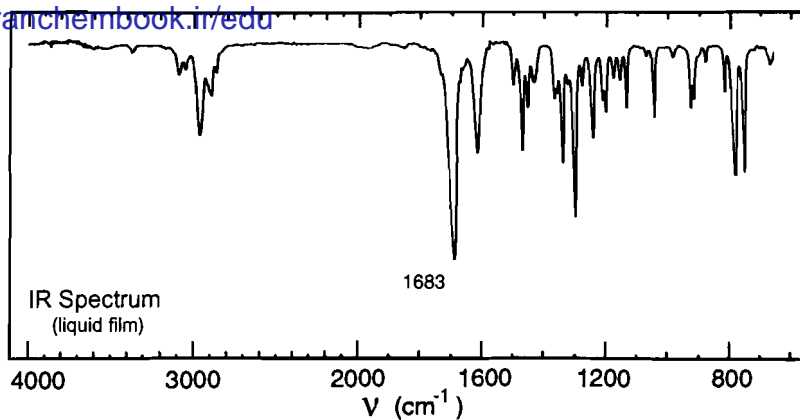

UV Spectrum

 $\lambda_{\text{max}}$  249 nm ( $\log_{10} \epsilon$  4.1) $\lambda_{\text{max}}$  292 nm ( $\log_{10} \epsilon$  3.3)

solvent: ethanol

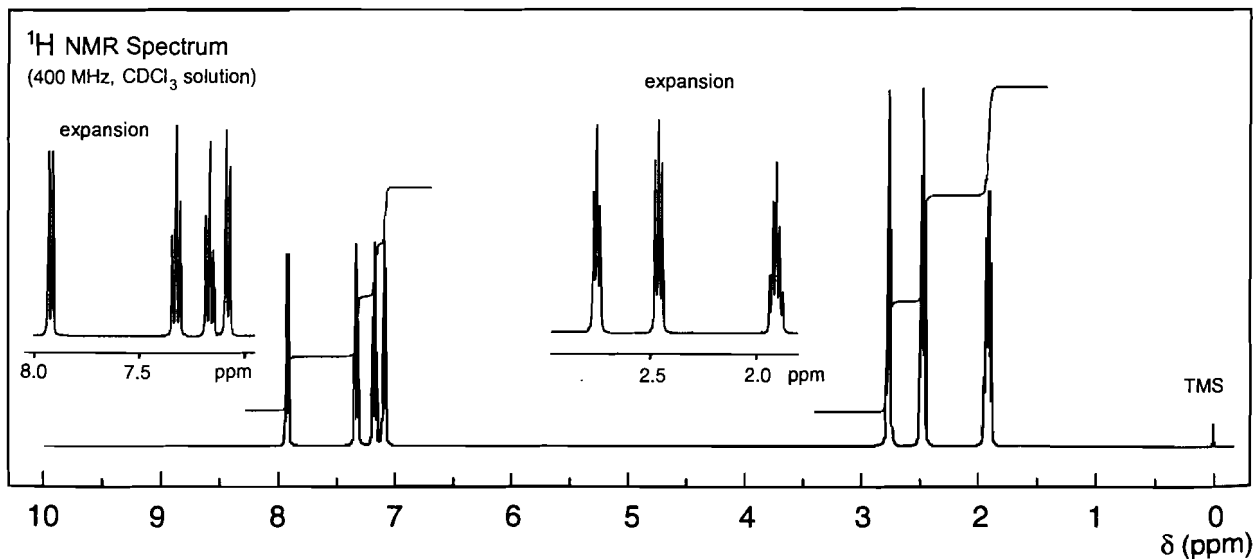
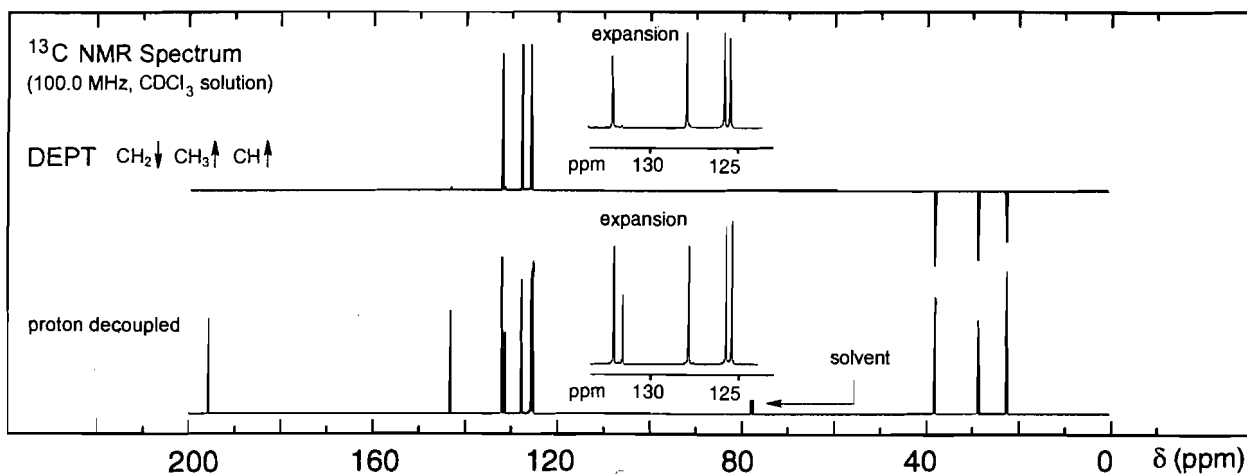

## Problem 174

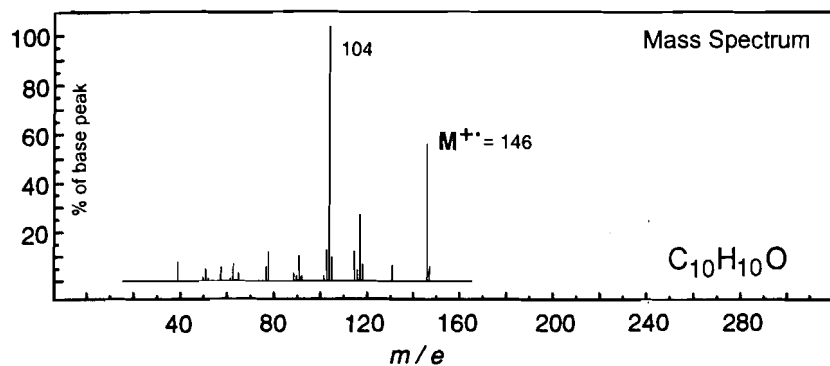
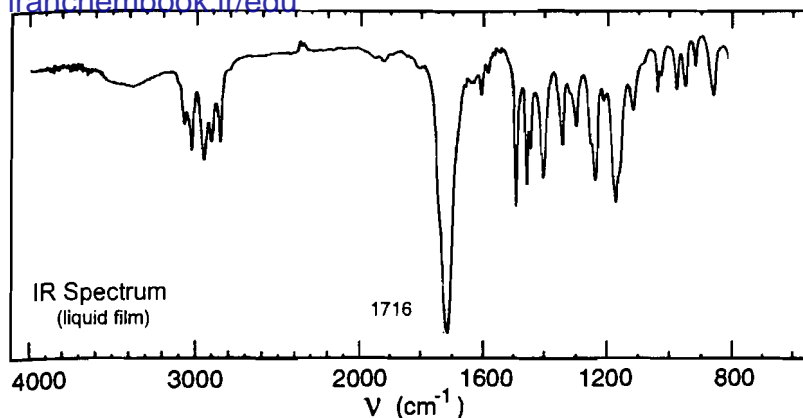

UV Spectrum

 $\lambda_{\text{max}}$  265 nm ( $\log_{10}\epsilon$  3.0) $\lambda_{\text{max}}$  272 nm ( $\log_{10}\epsilon$  3.1) $\lambda_{\text{max}}$  294 nm ( $\log_{10}\epsilon$  1.9)

solvent : ethanol

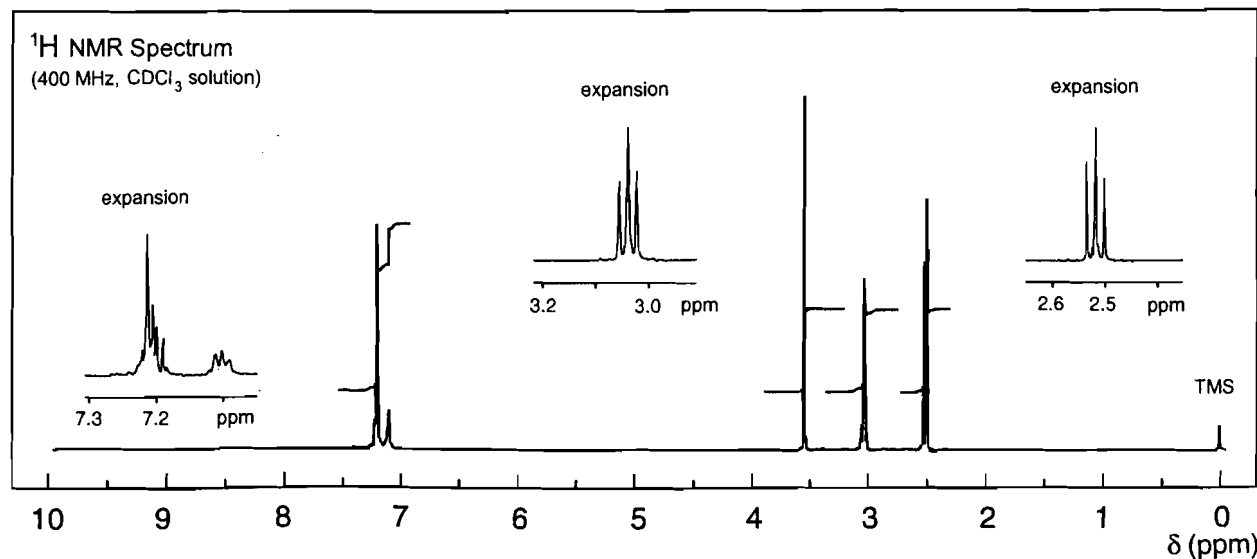
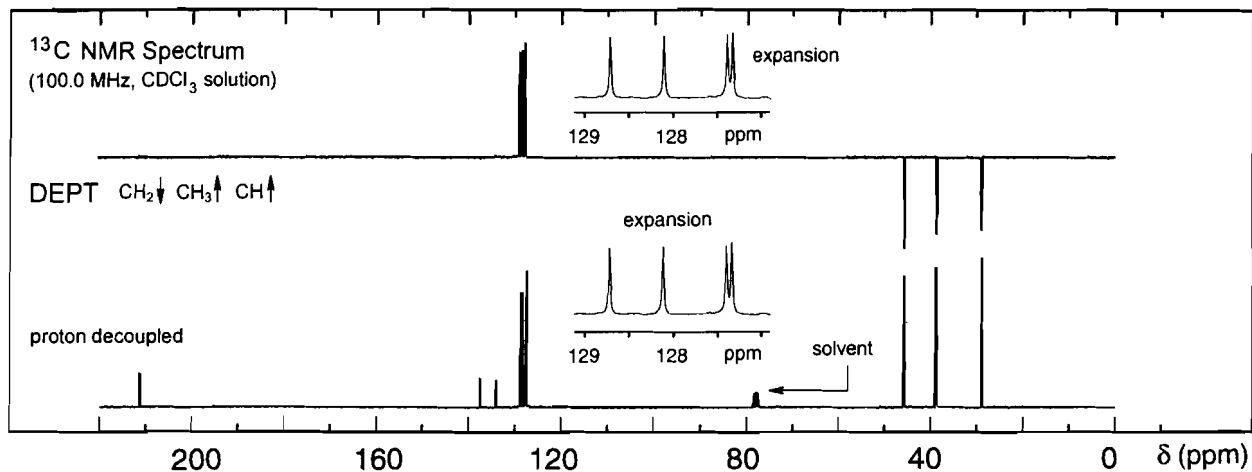



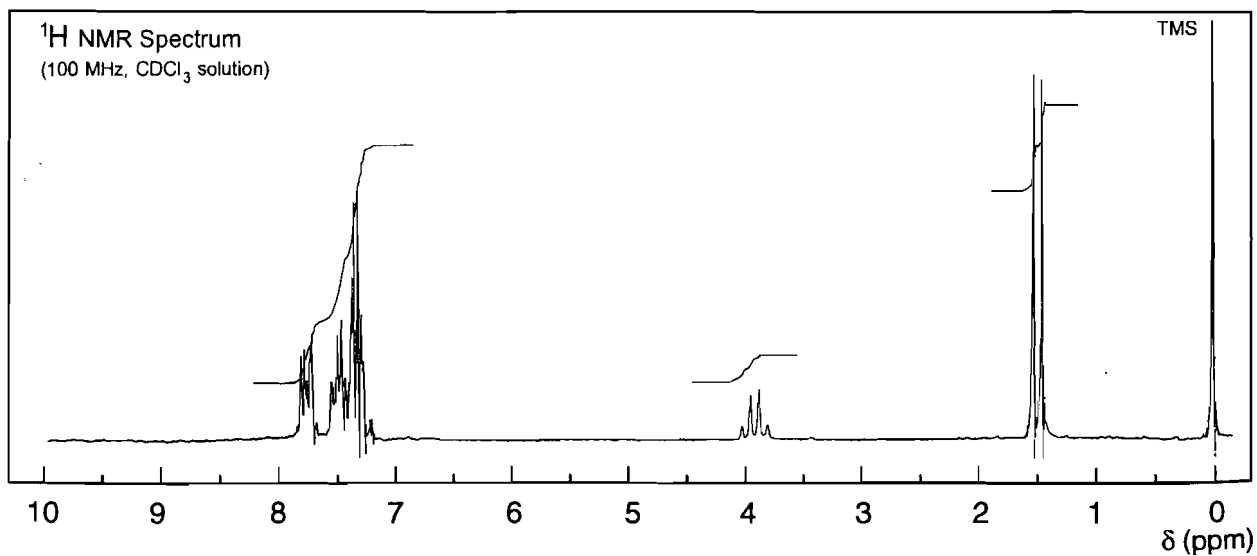
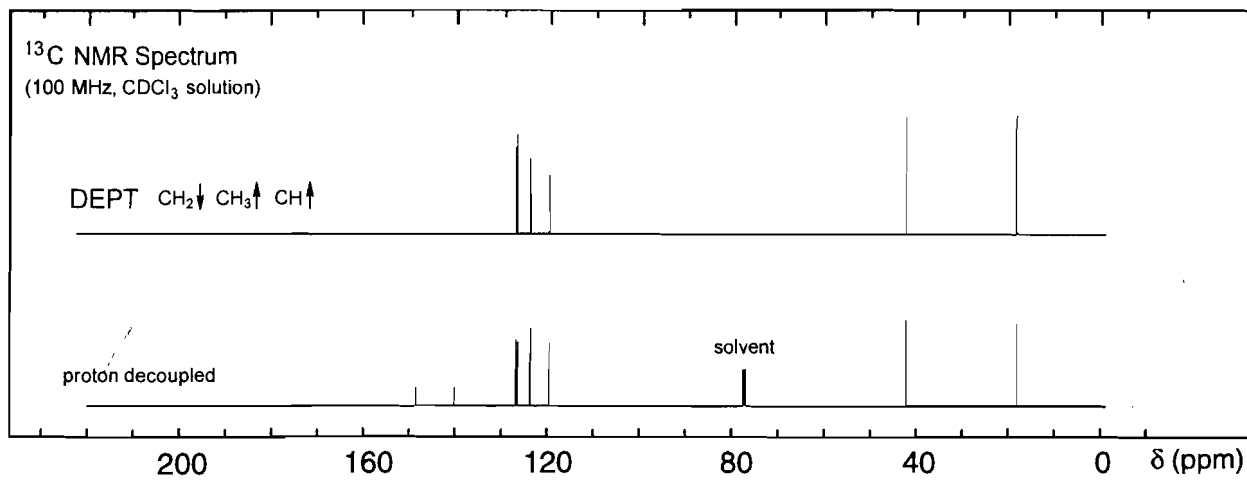
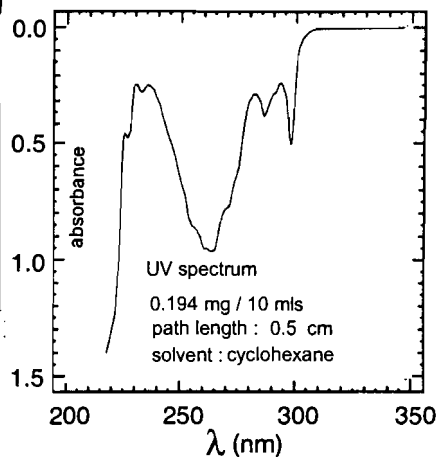
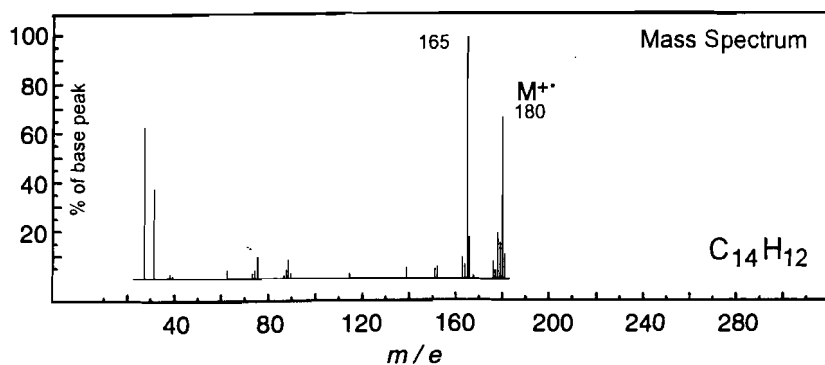
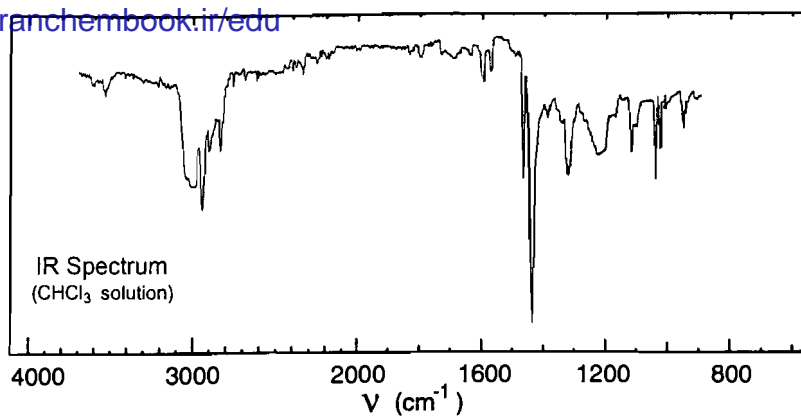

## Problem 176

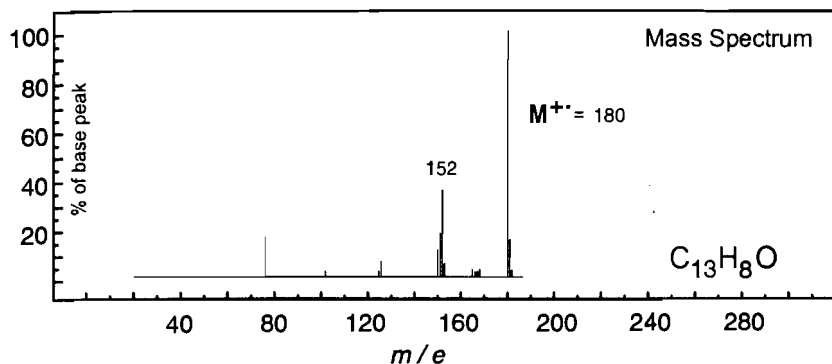
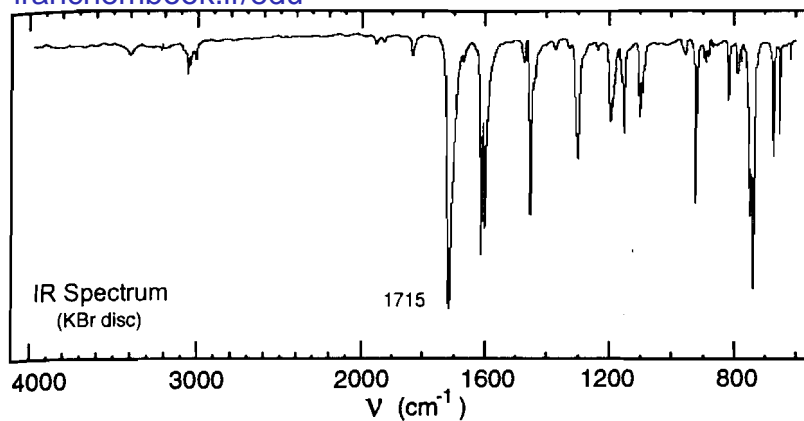

UV Spectrum

 $\lambda_{\text{max}}$  265 nm ( $\log_{10} \epsilon$  4.5) $\lambda_{\text{max}}$  330 nm ( $\log_{10} \epsilon$  4.2)

solvent: ethanol

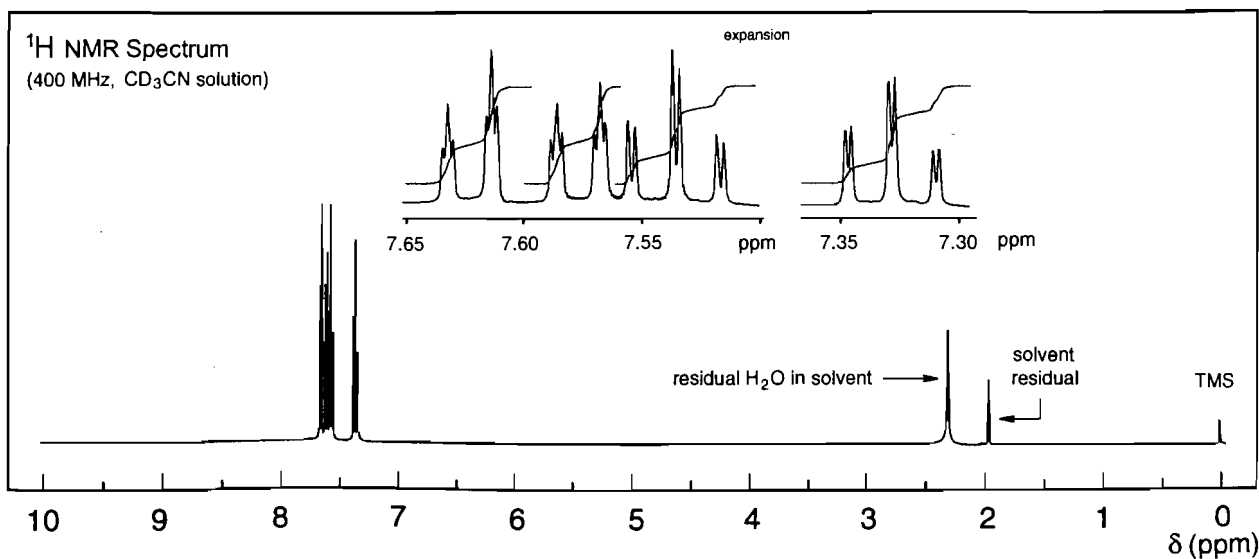
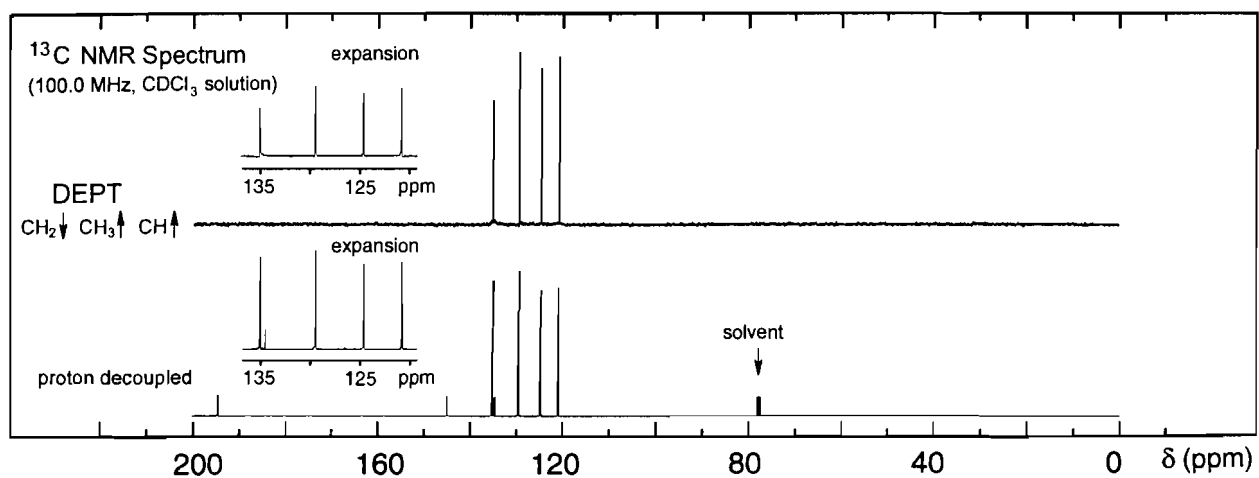

## Problem 177

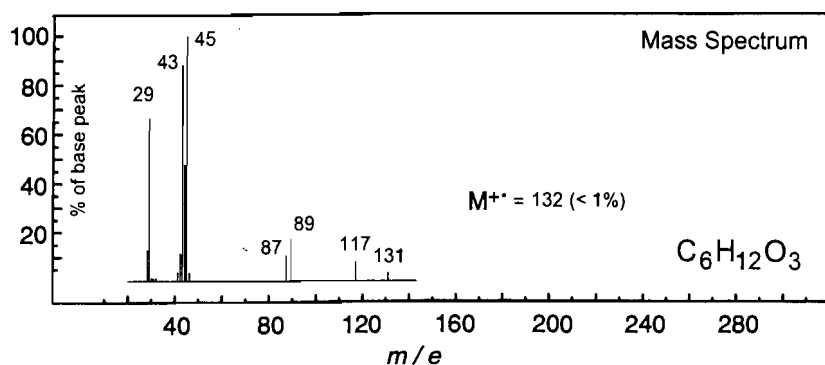
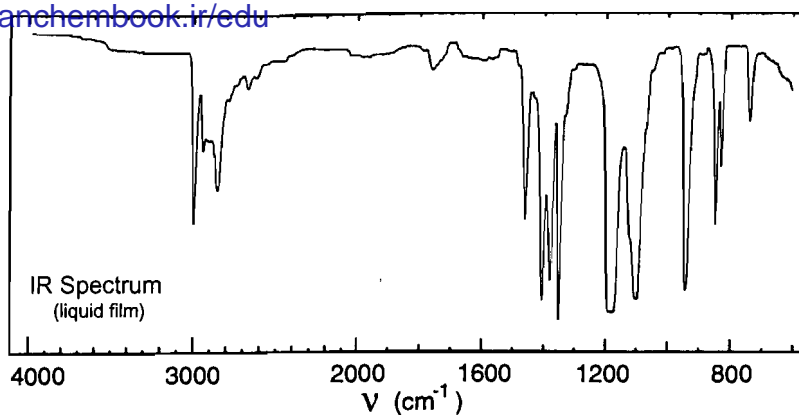

No significant UV  
absorption above 220 nm

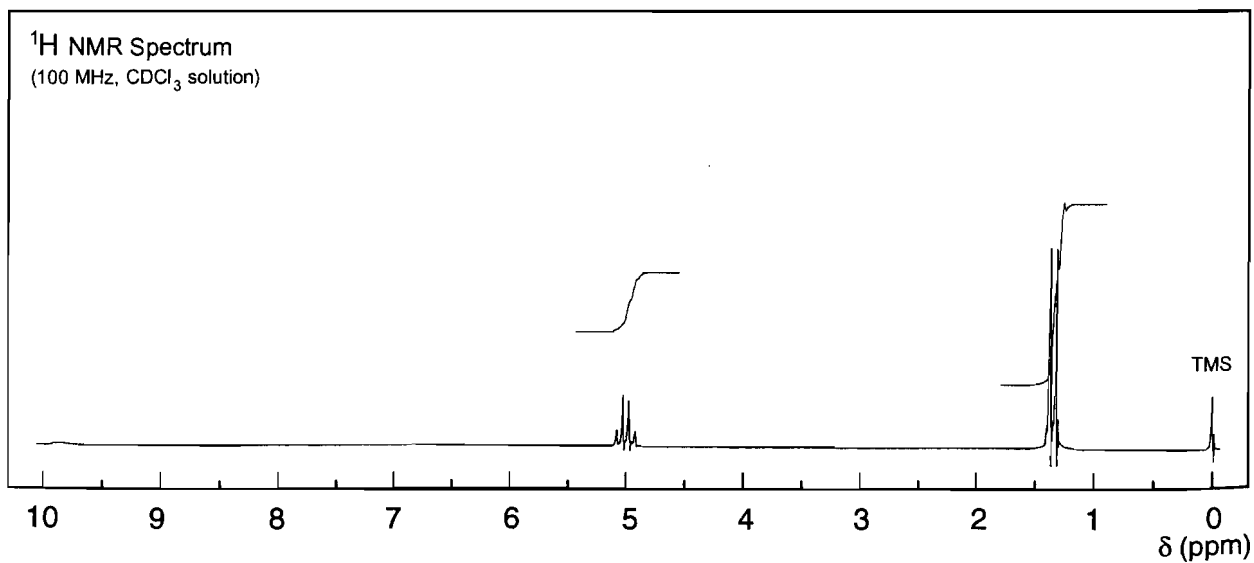
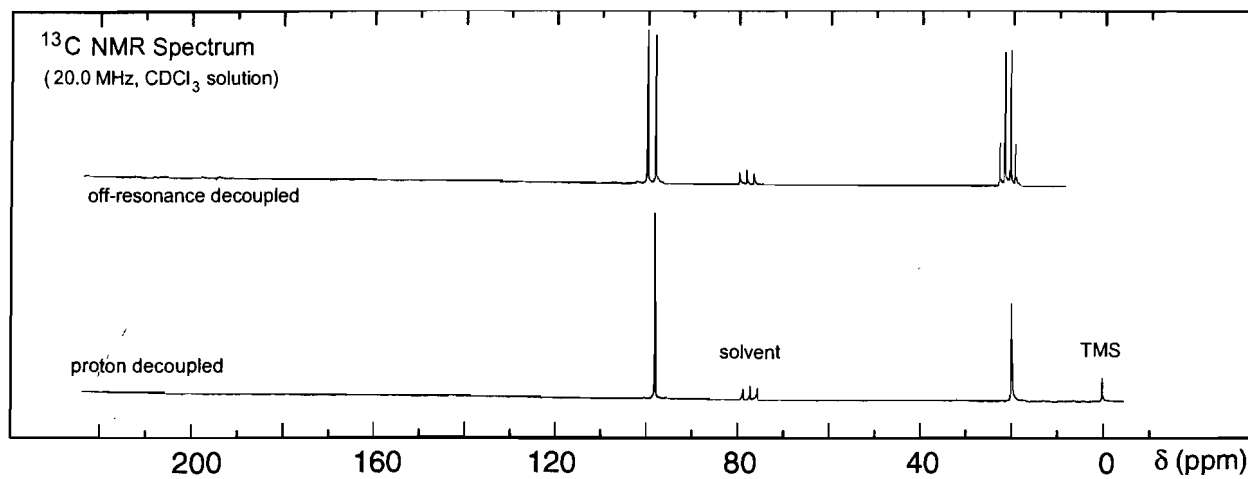

## Problem 178

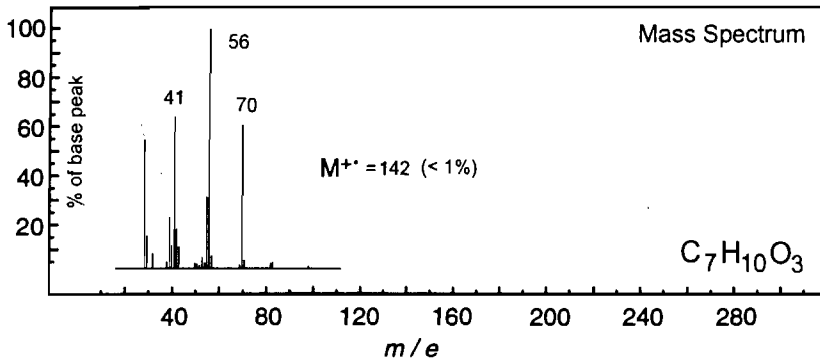
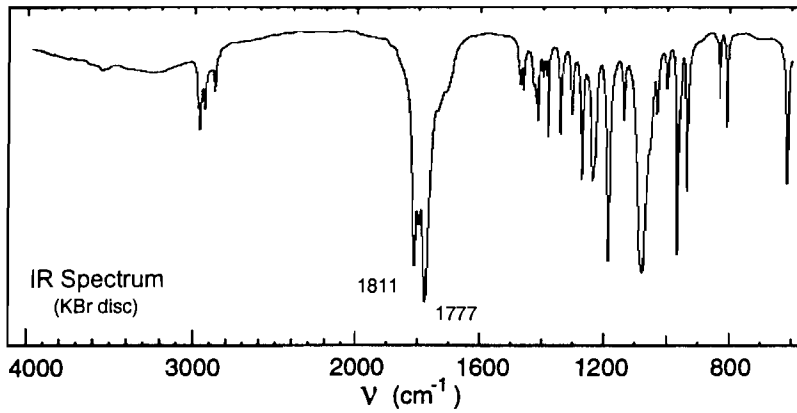

No significant UV  
absorption above 220 nm

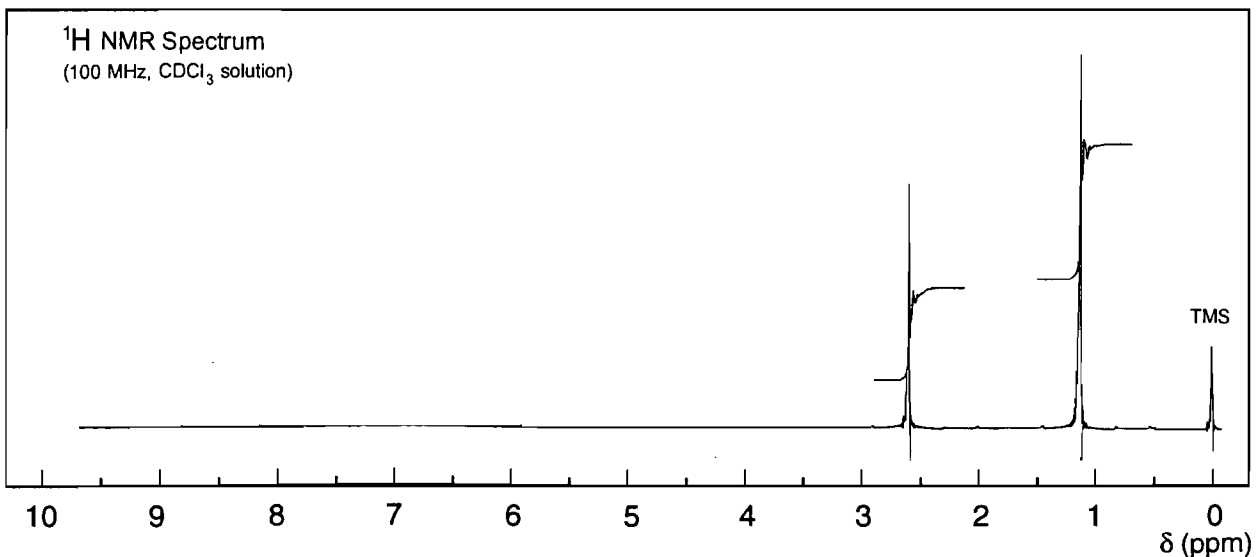
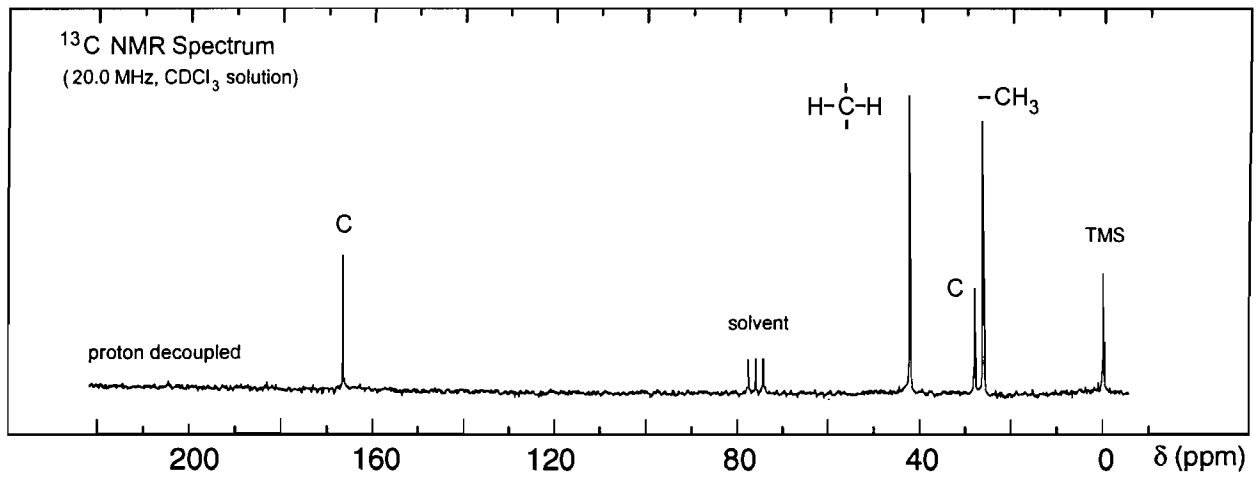

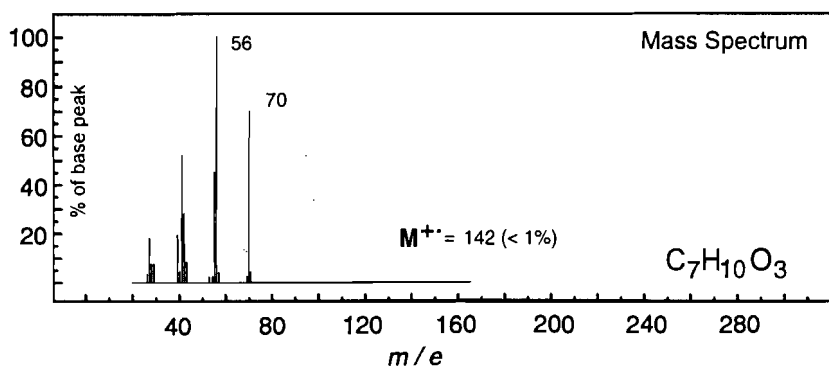
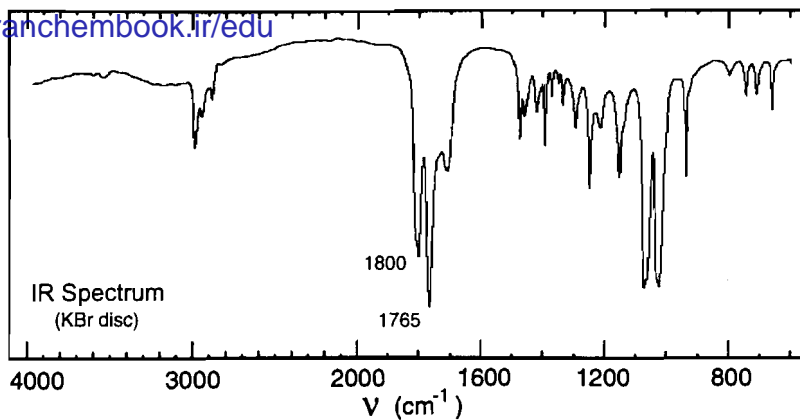

No significant UV  
absorption above 220 nm

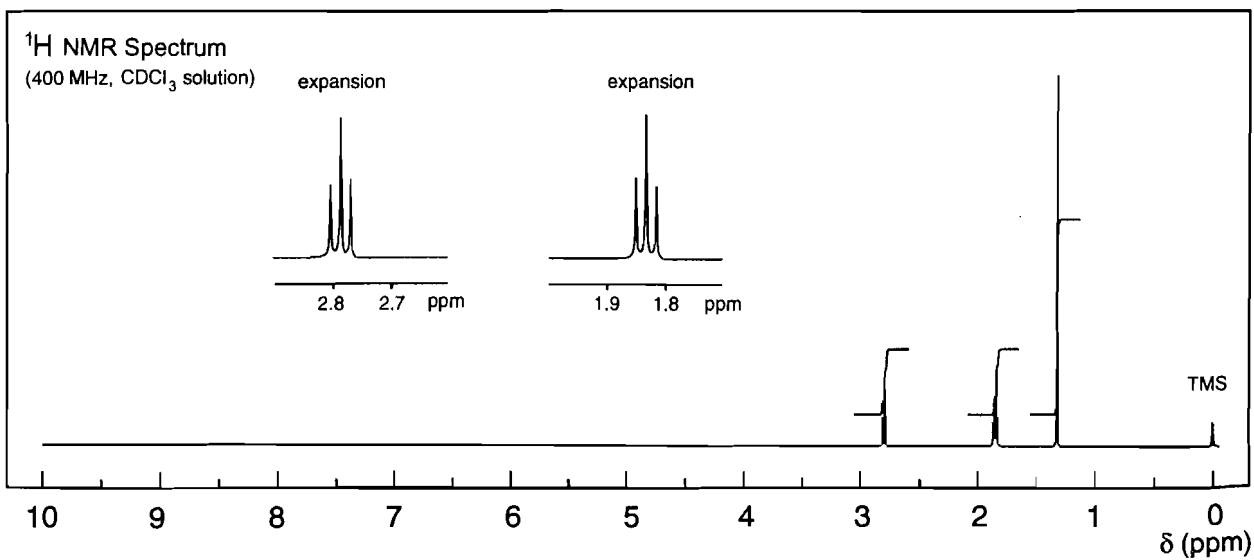
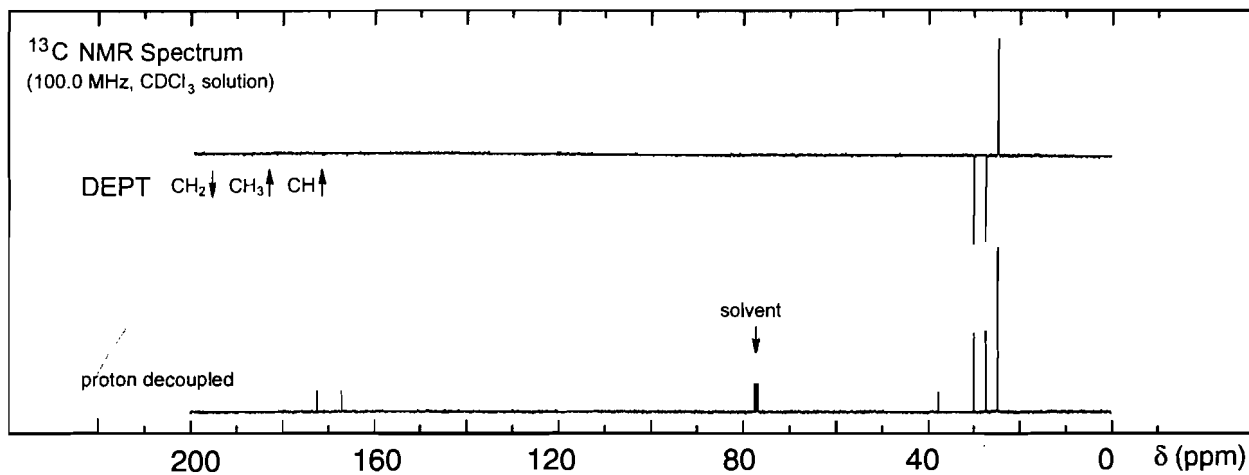

# Problem 180

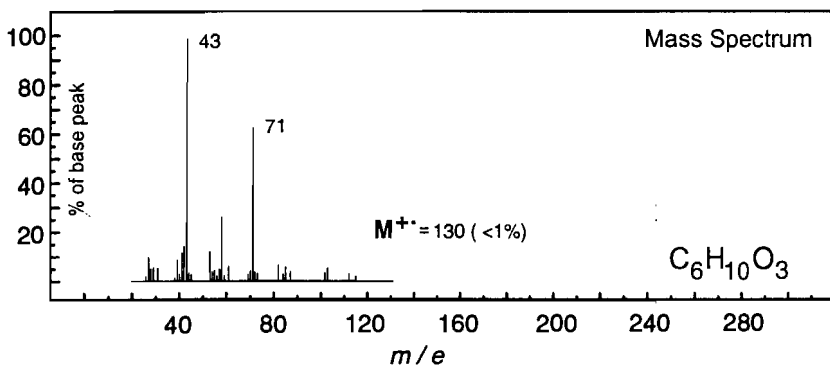
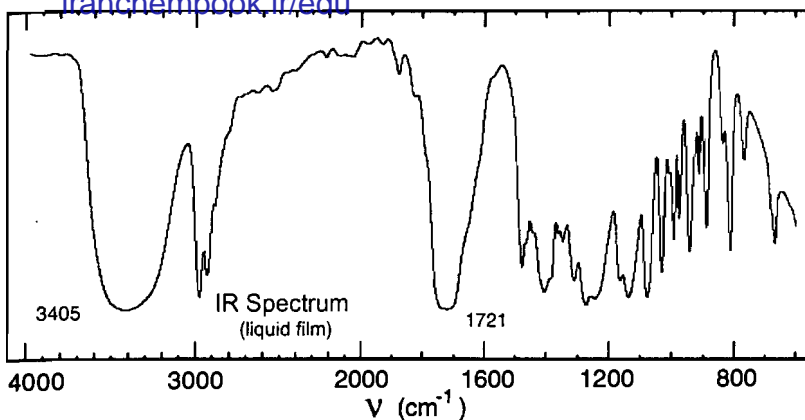

No significant UV absorption above 220 nm

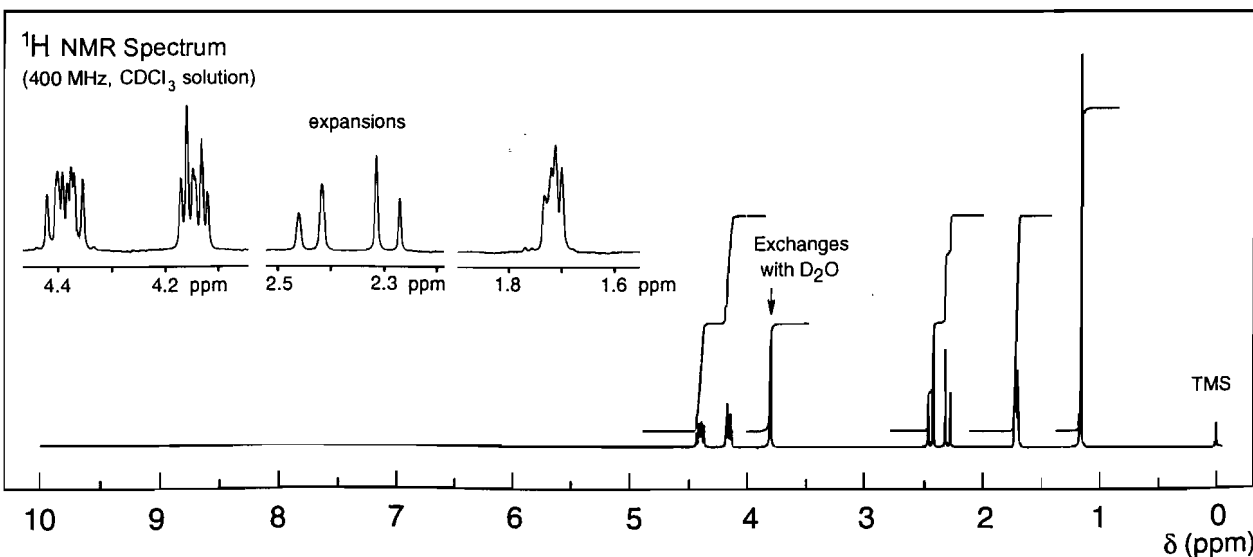
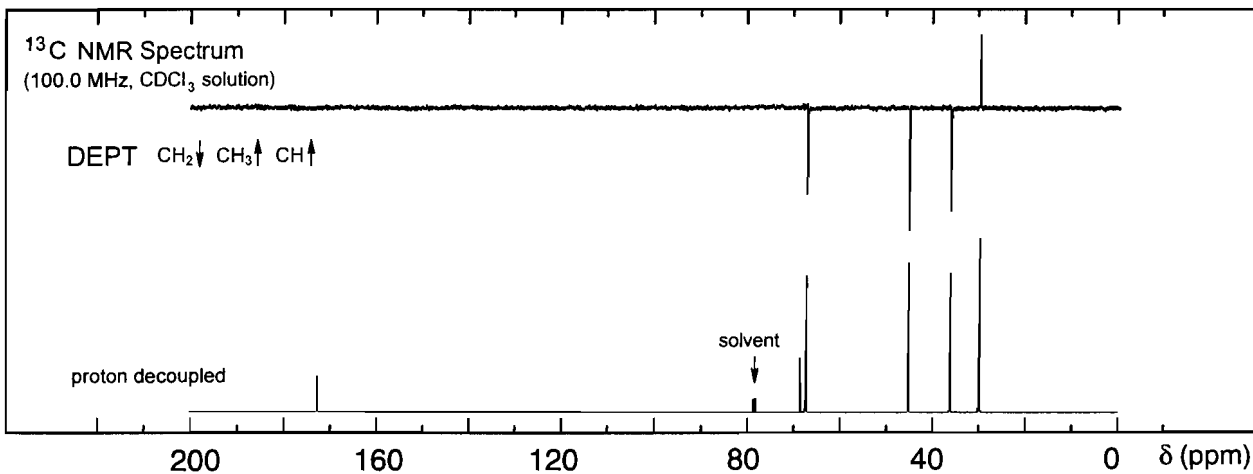

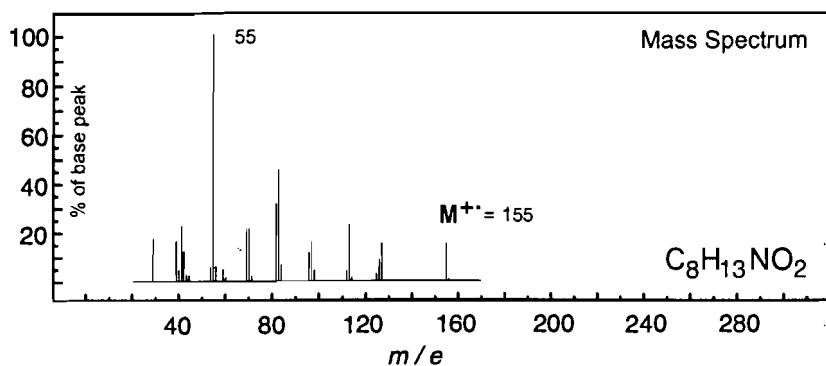
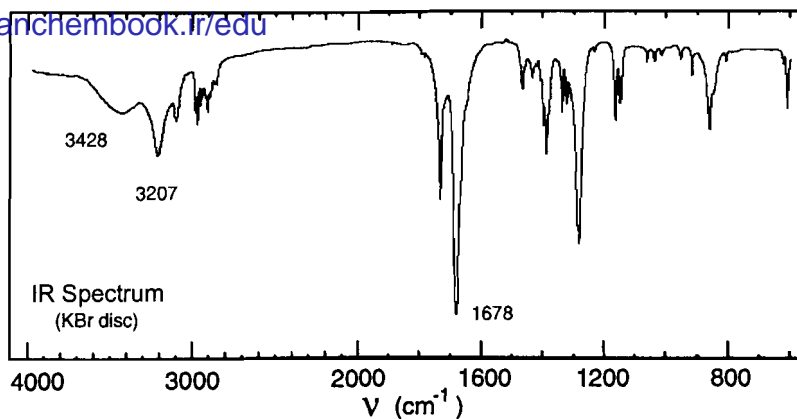

UV Spectrum

 $\lambda_{\max}$  230 nm ( $\log_{10} \epsilon$  3.6) pH 11 $\lambda_{\max}$  230 nm ( $\log_{10} \epsilon$  4.4) pH 13

solvent: water

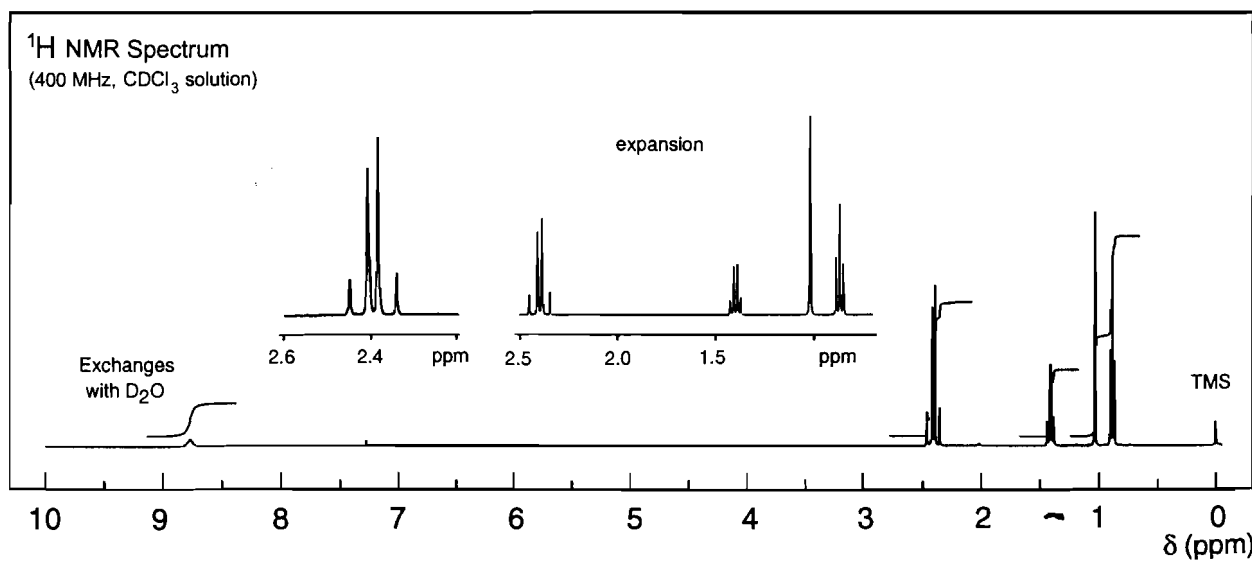
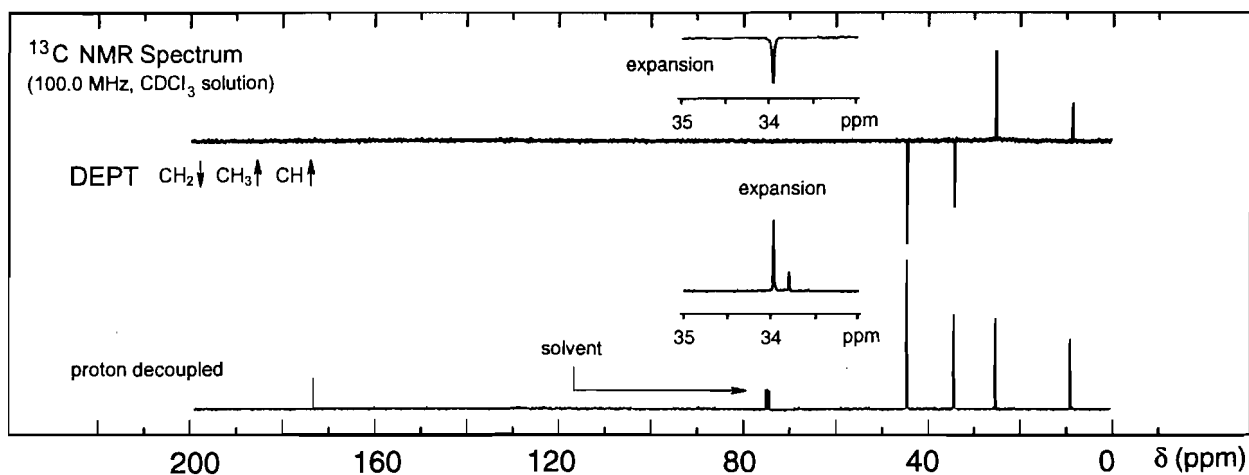

# Problem 182

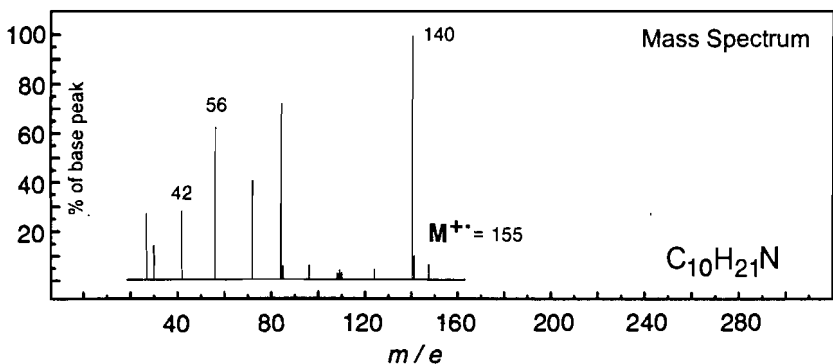
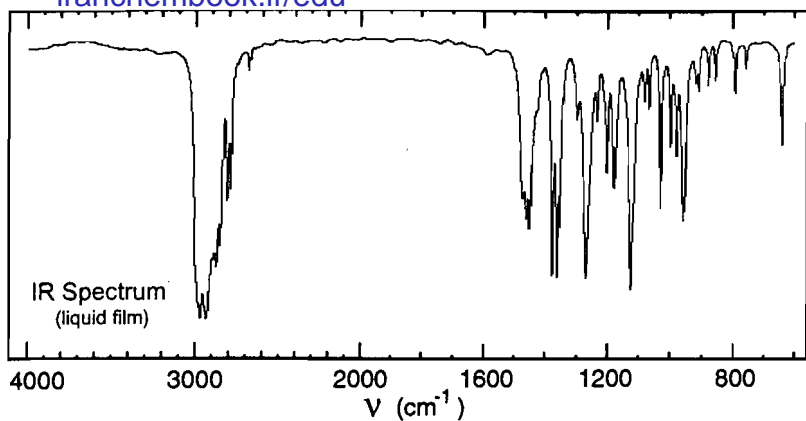

No significant UV absorption above 220 nm

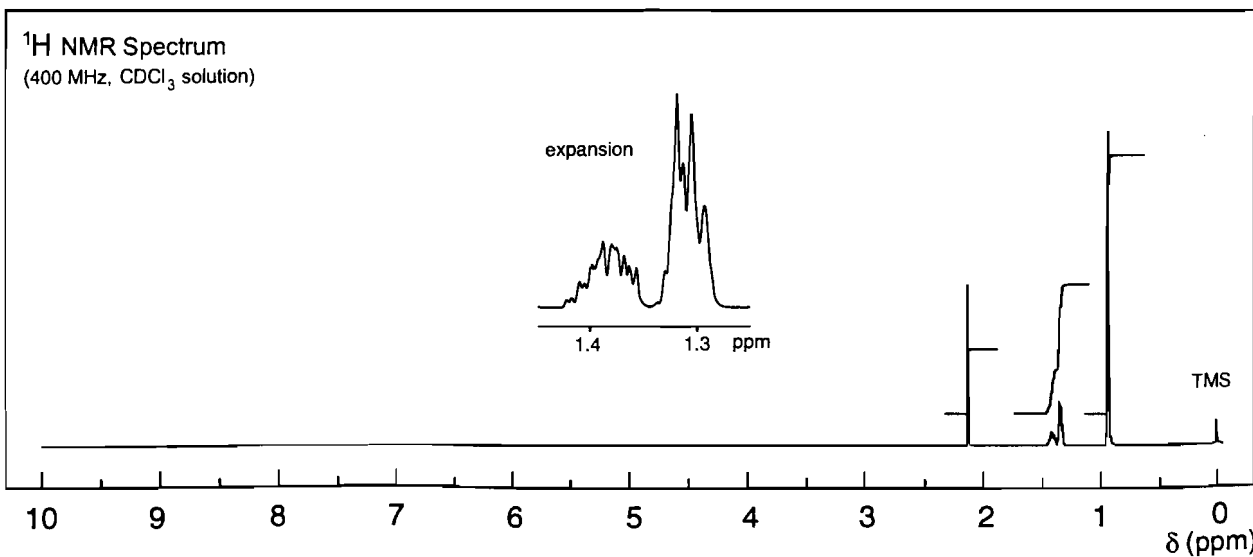
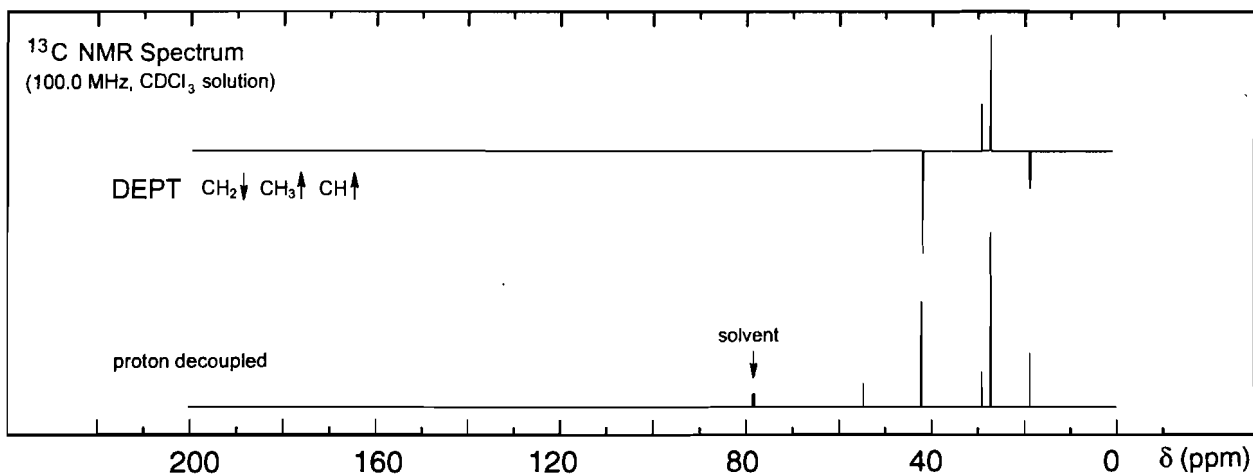



## Problem 183

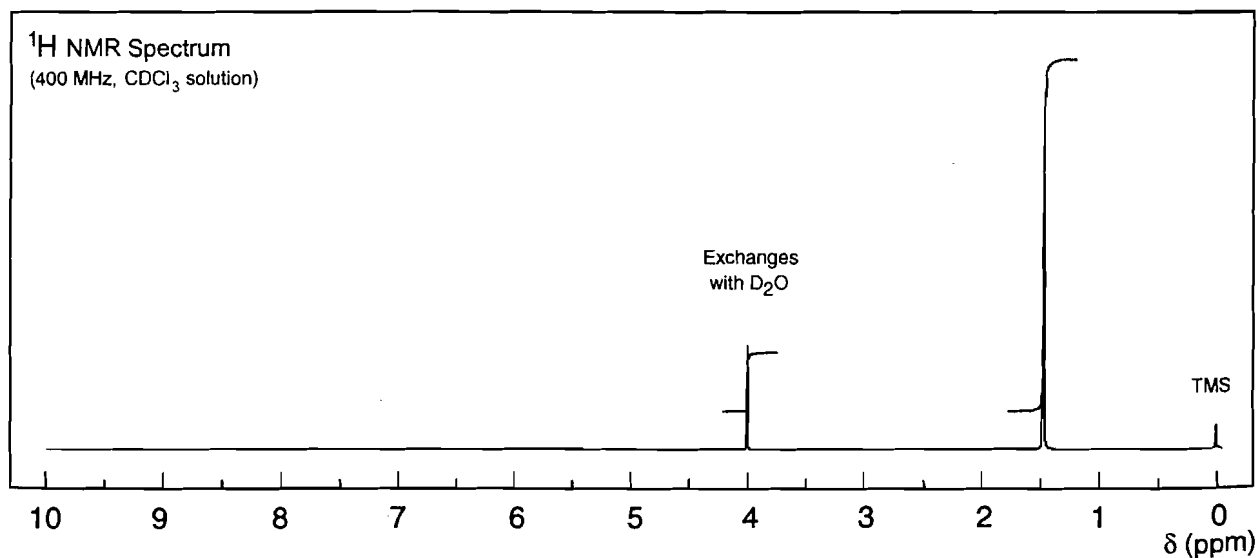
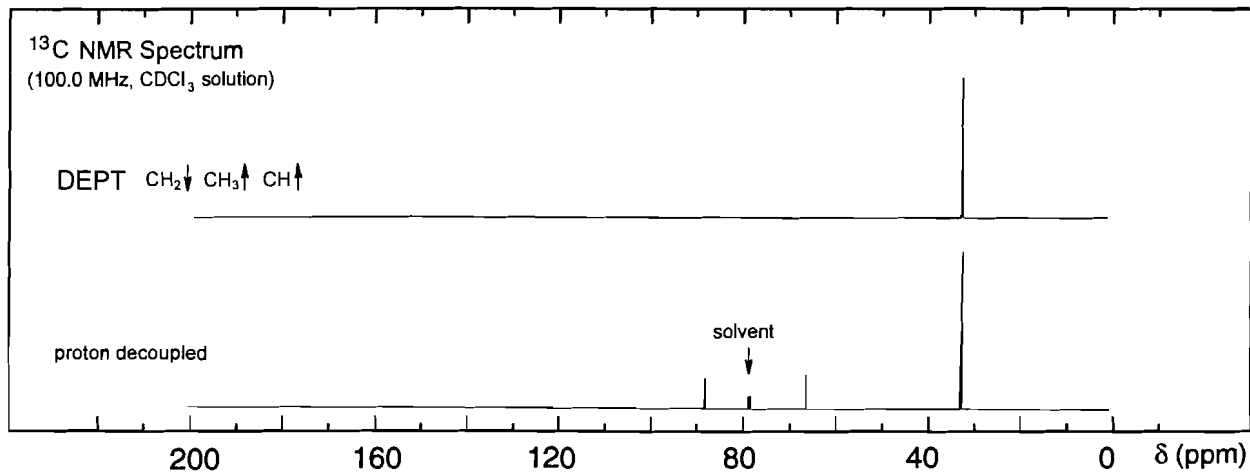
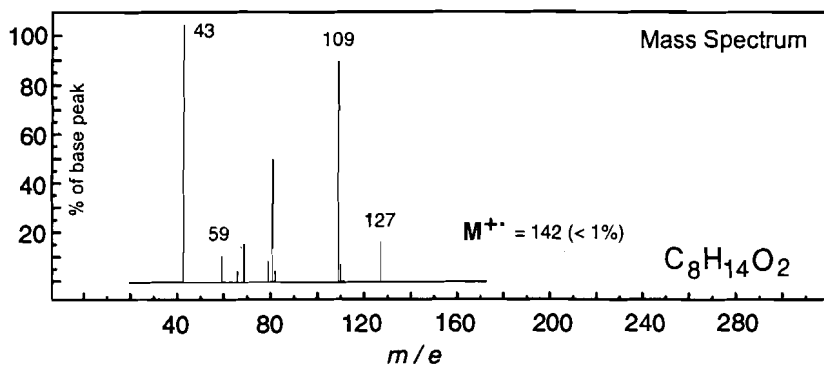
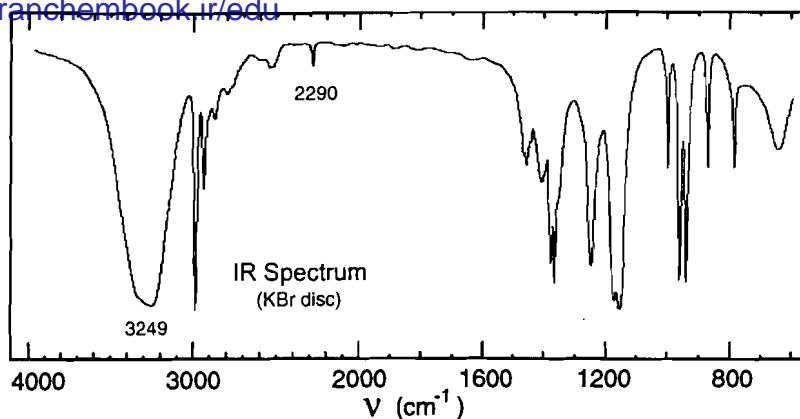

# Problem 184

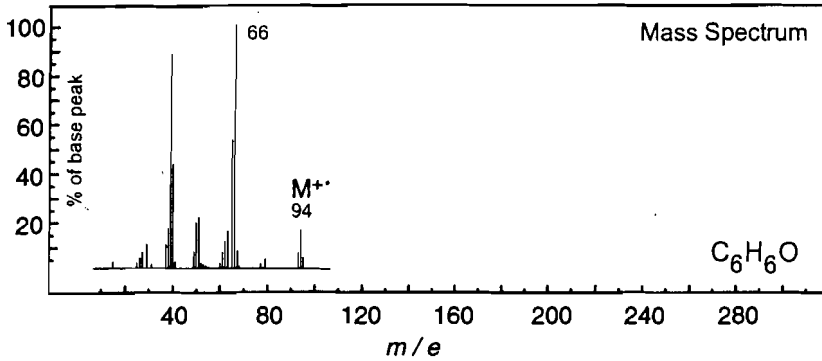
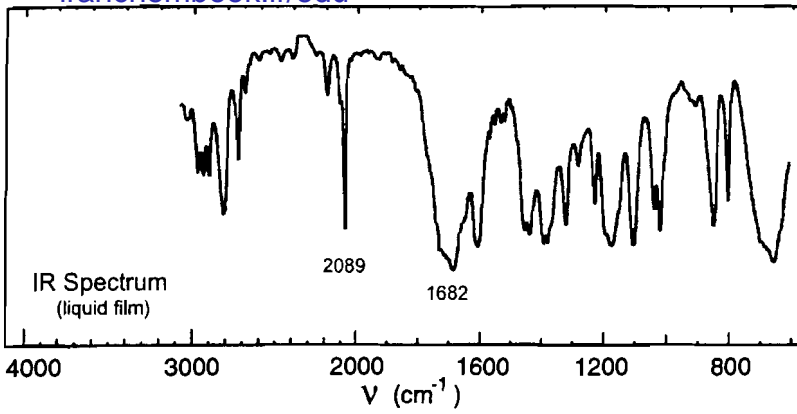

UV Spectrum

$\log_{10} \epsilon > 4.0$

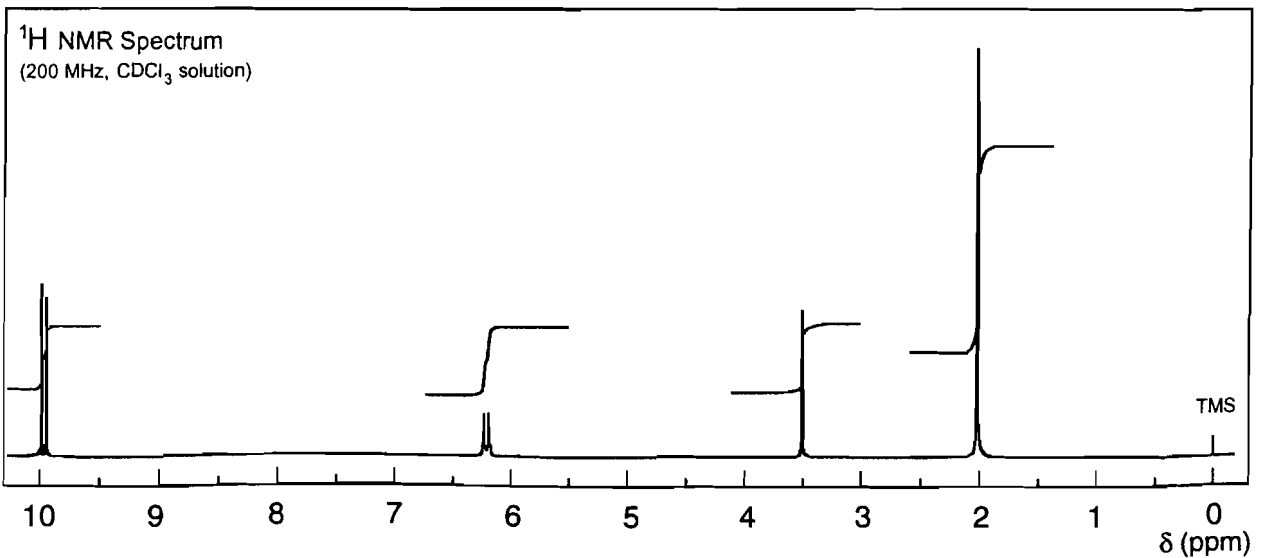
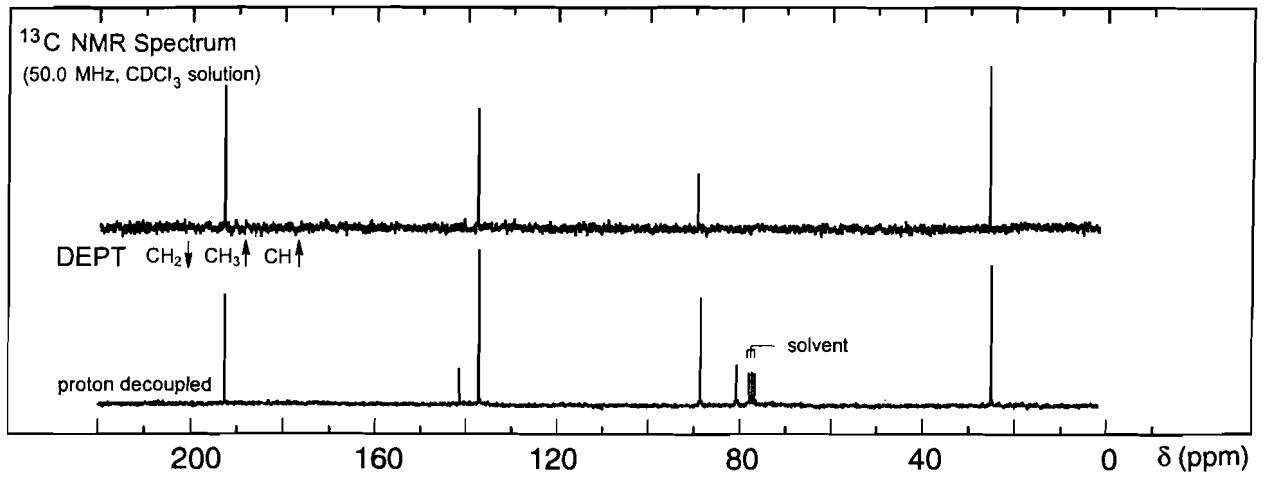

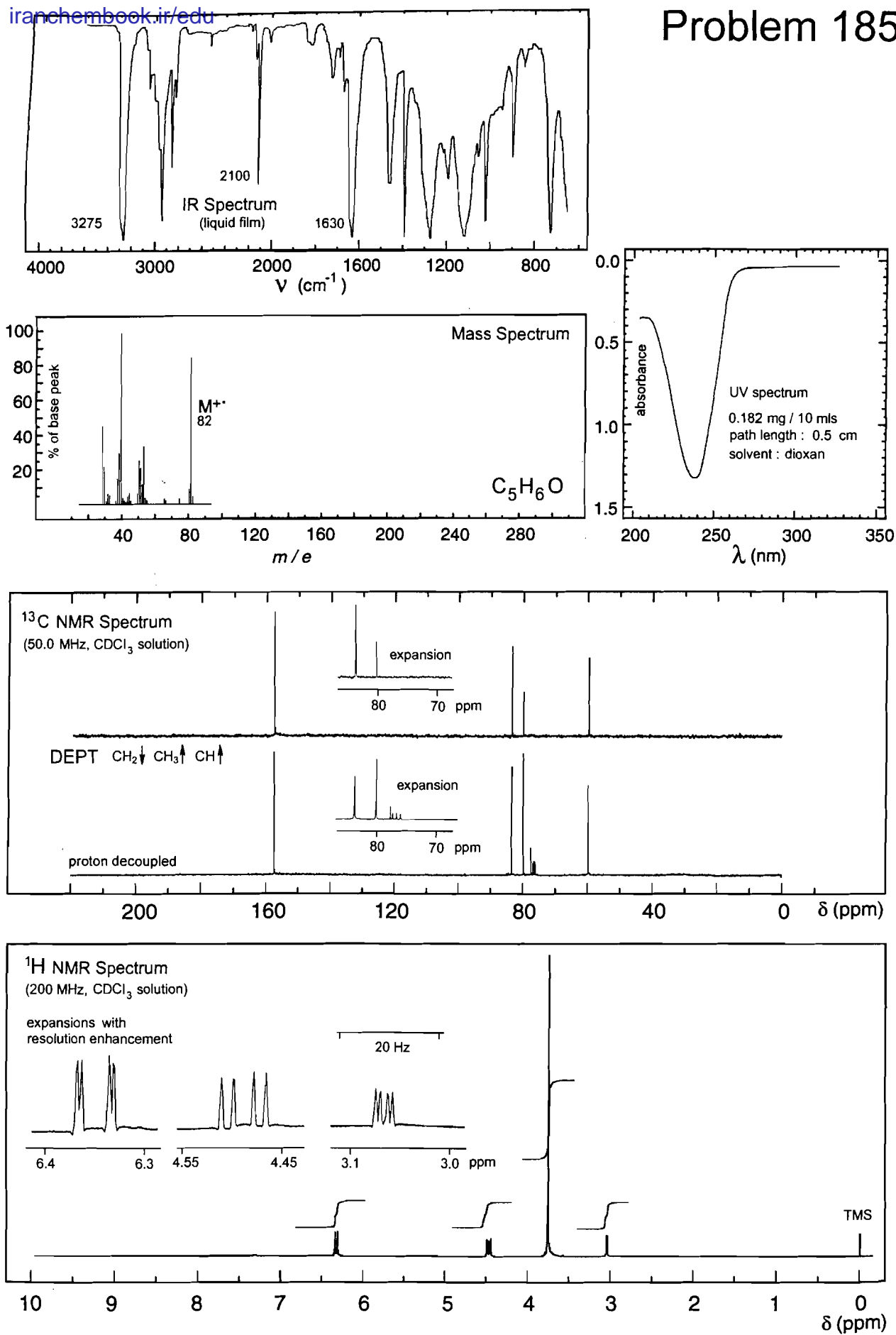

## Problem 186

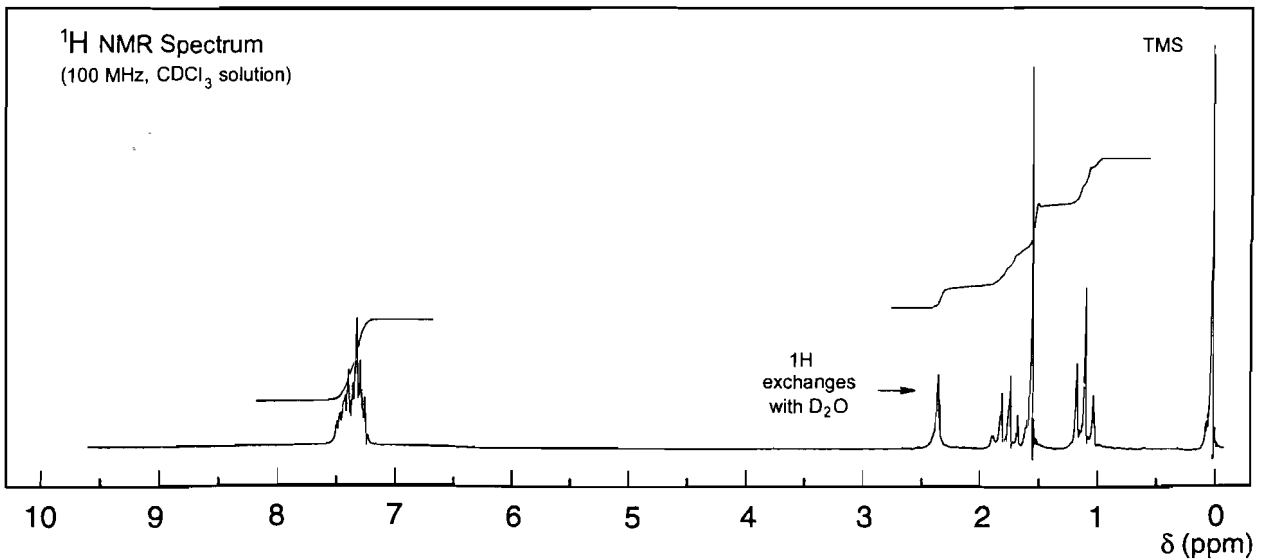
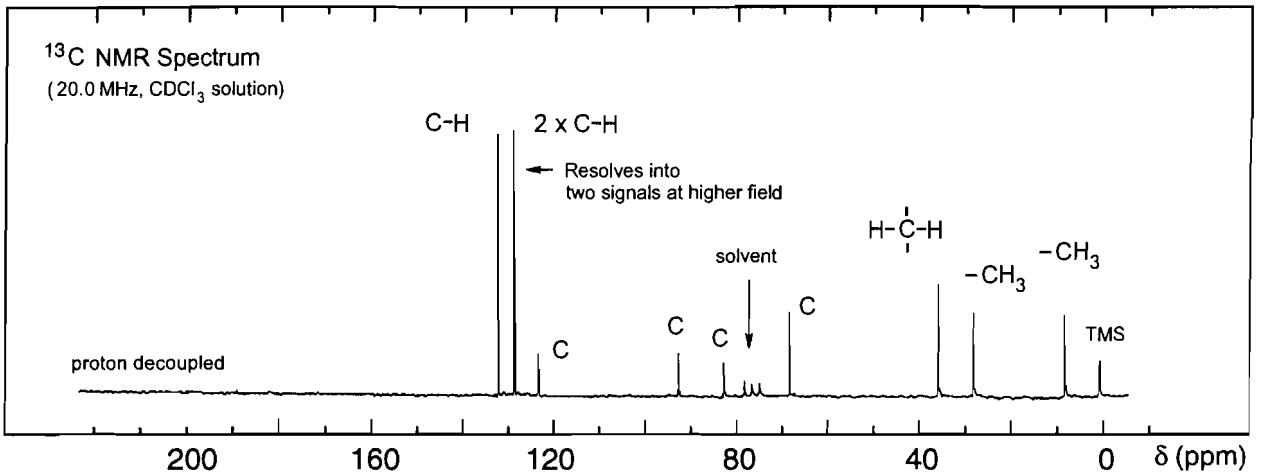
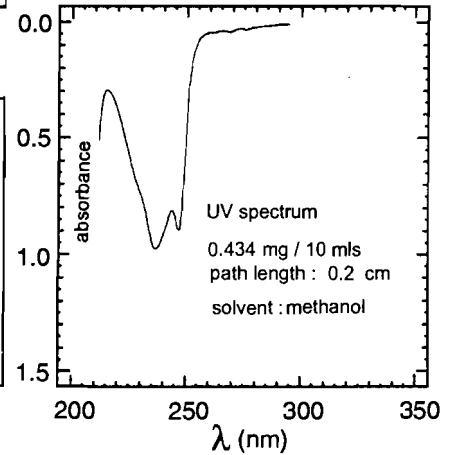
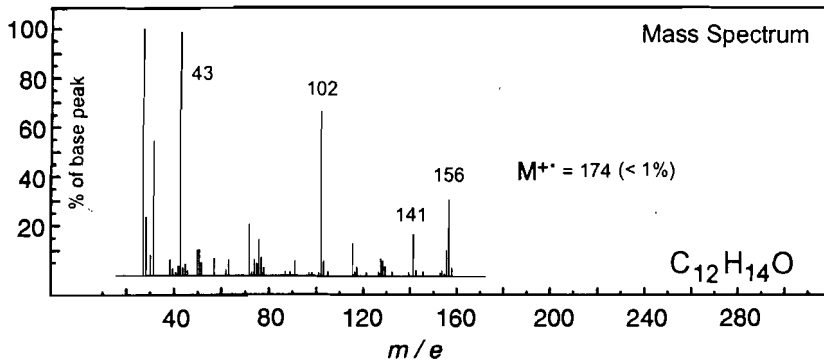
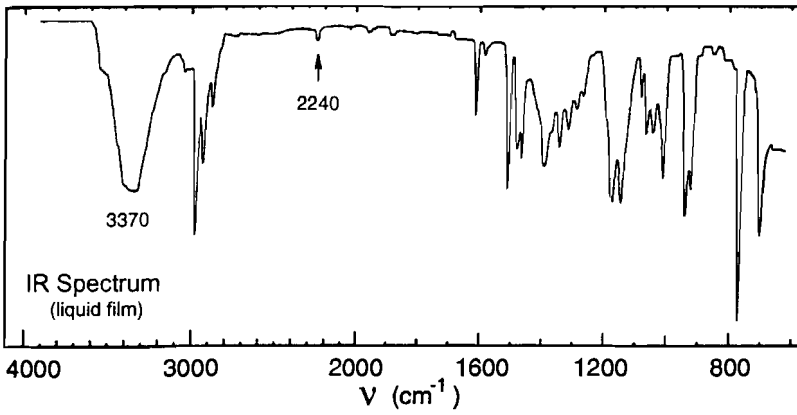

# Problem 187

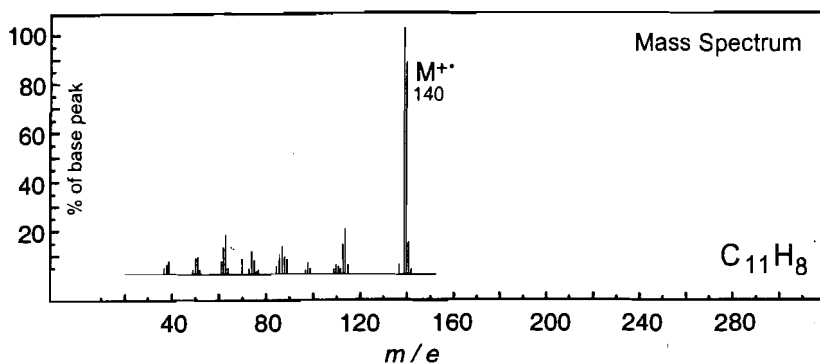
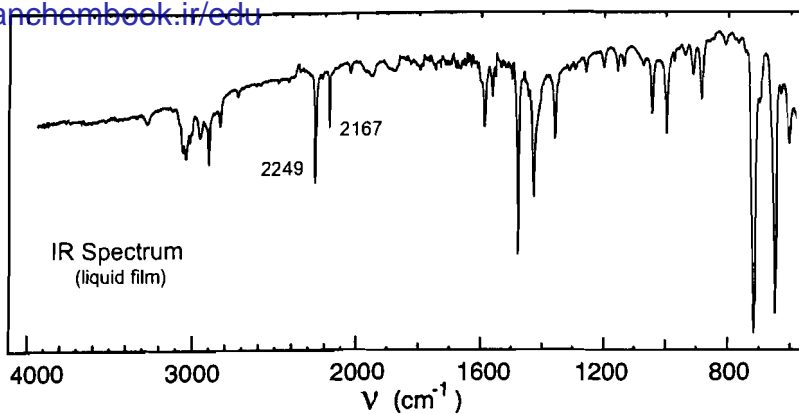

UV Spectrum

$$\log_{10} \epsilon > 4.0$$

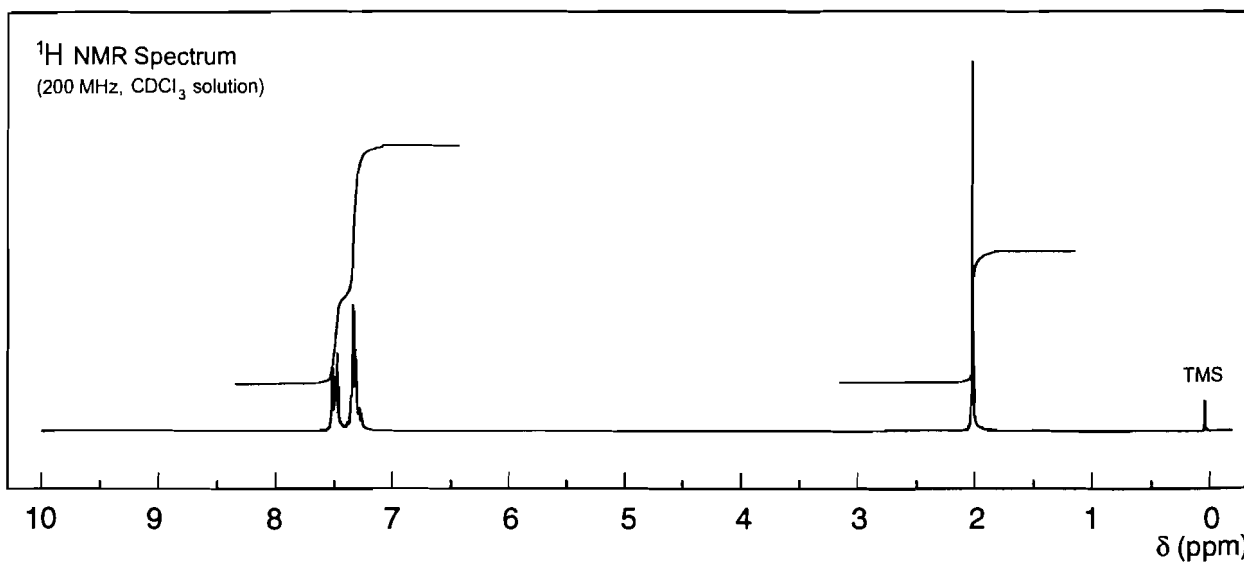
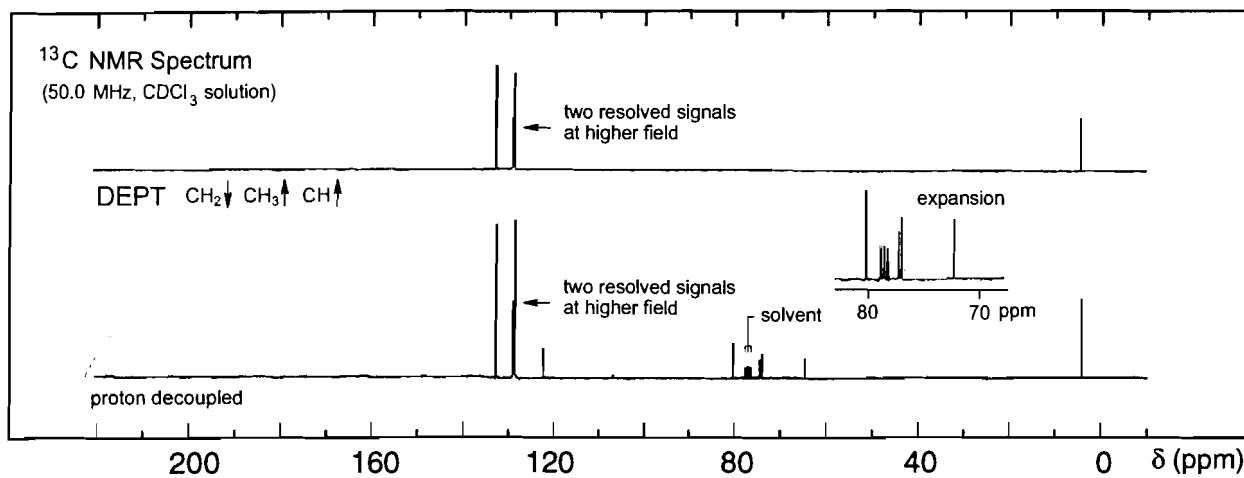

## Problem 188

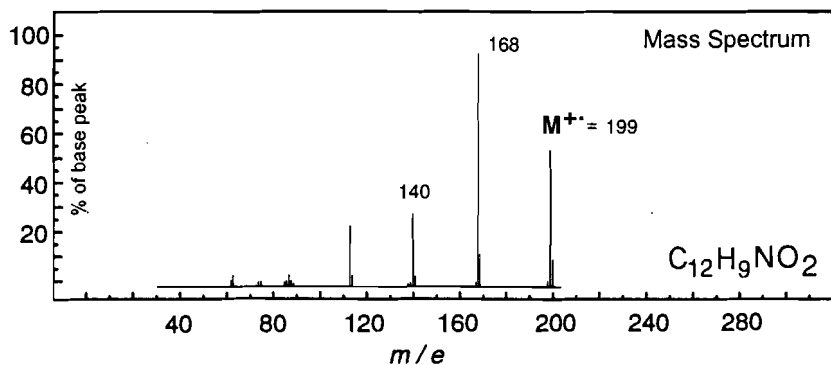
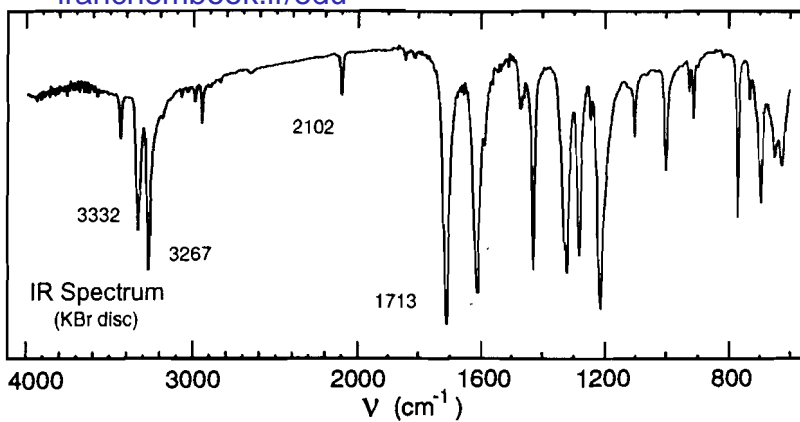

UV Spectrum

$$\log_{10} \epsilon > 4.0$$

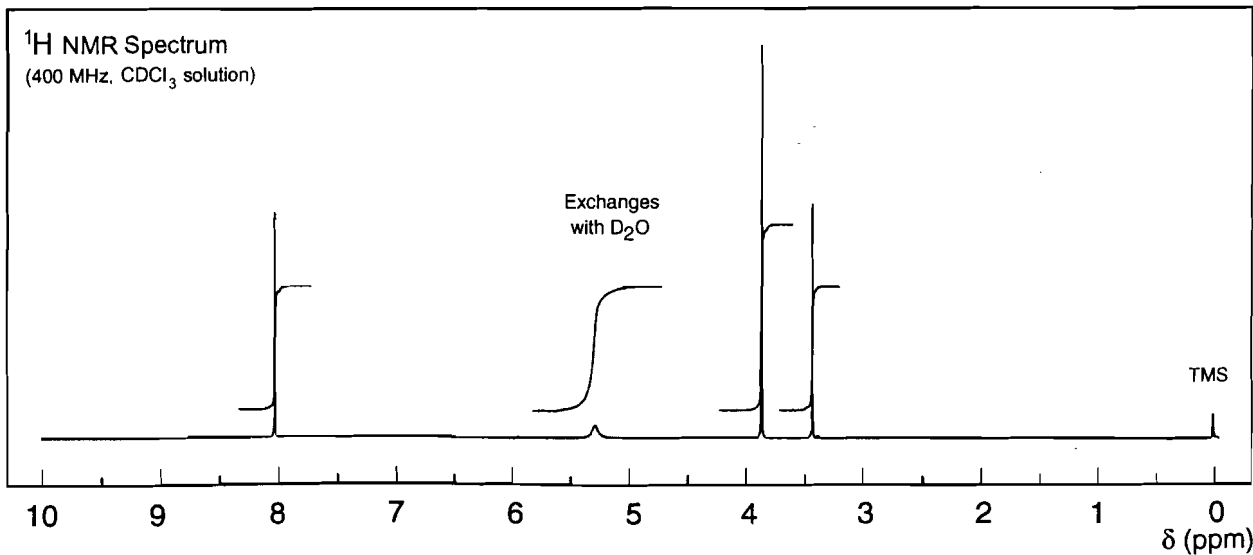
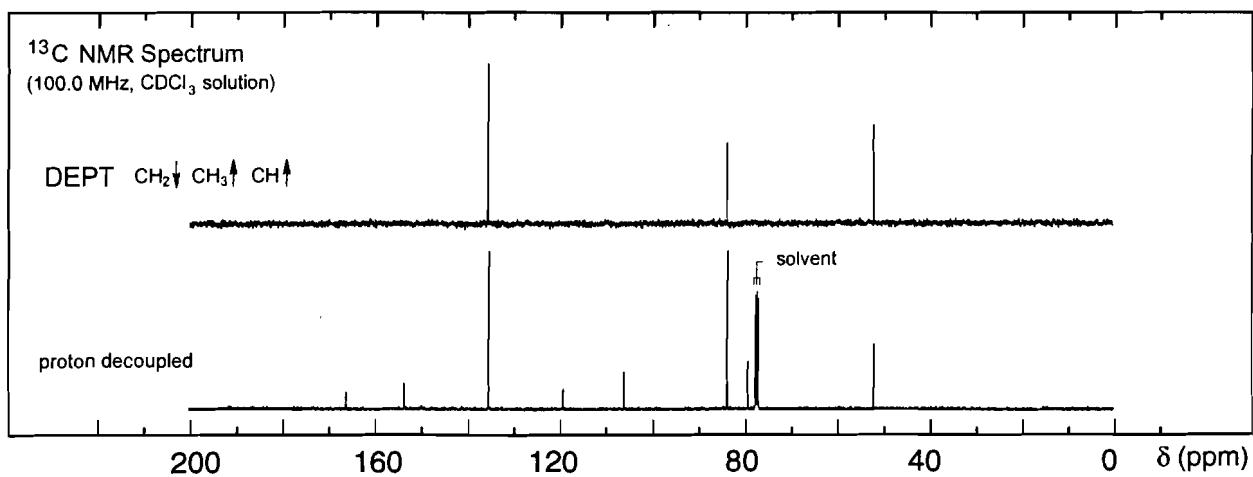

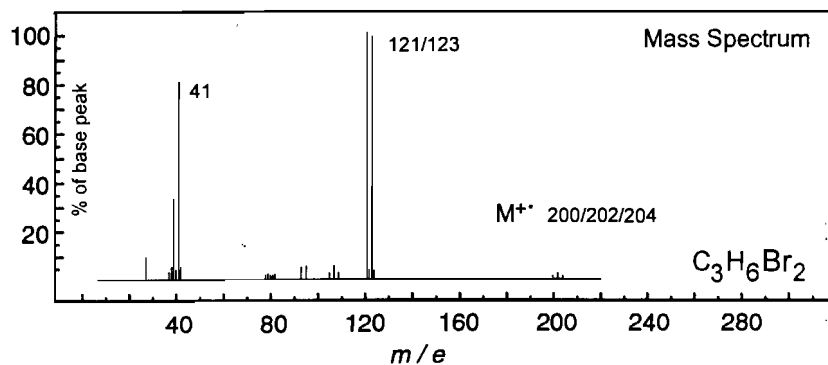
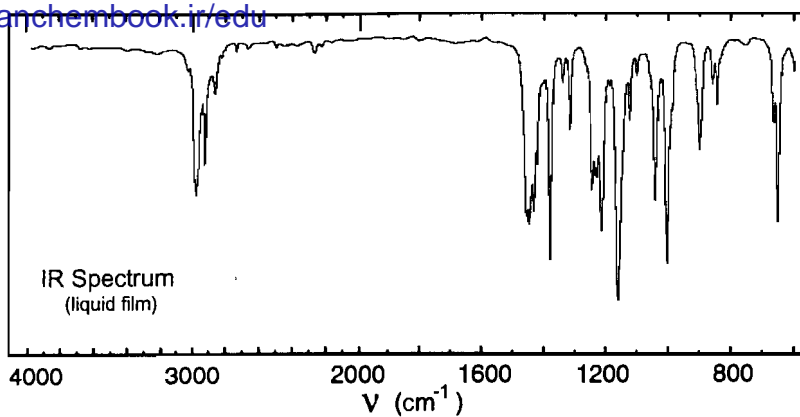

No significant UV  
absorption above 220 nm

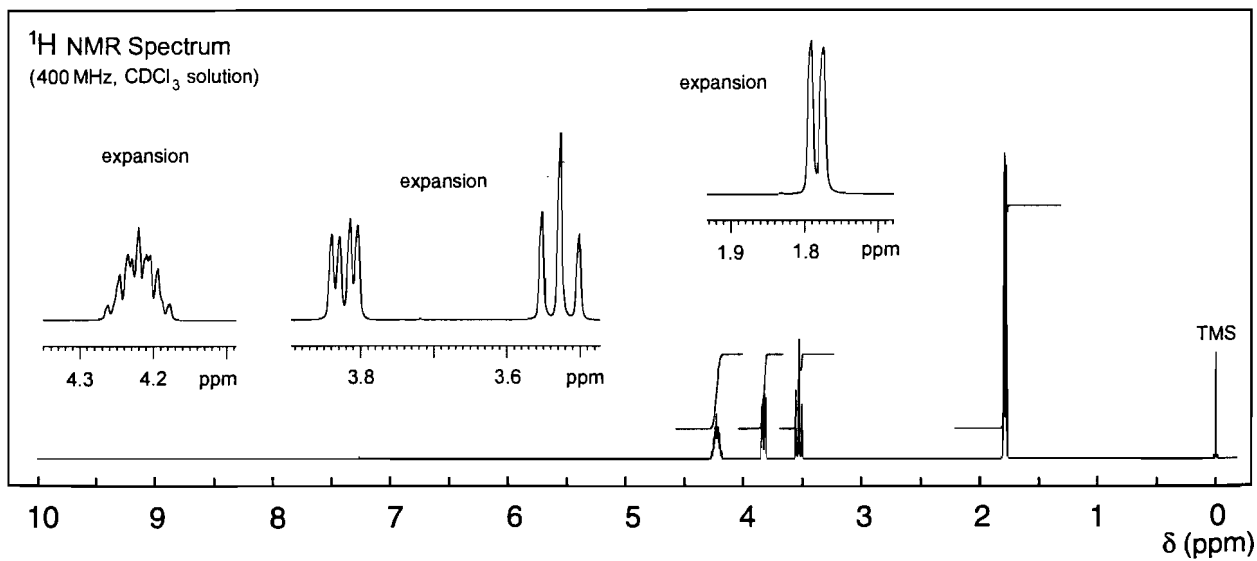
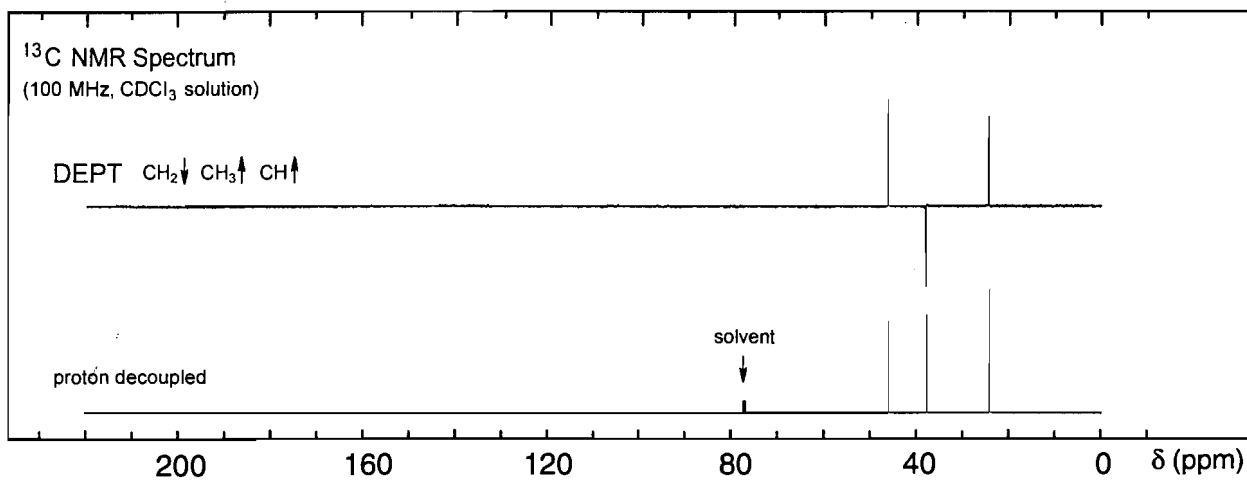

# Problem 190

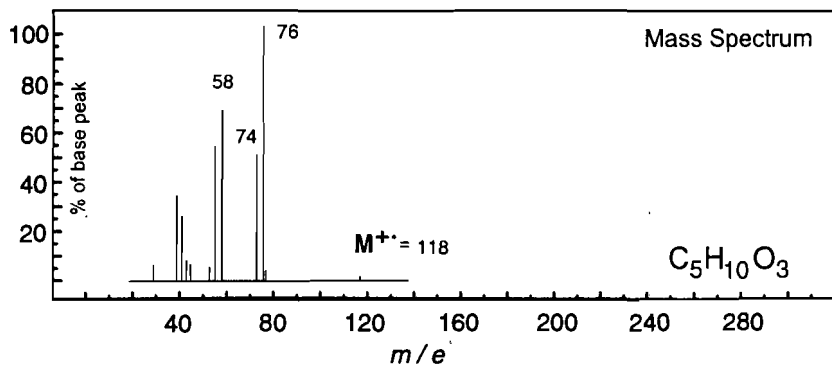
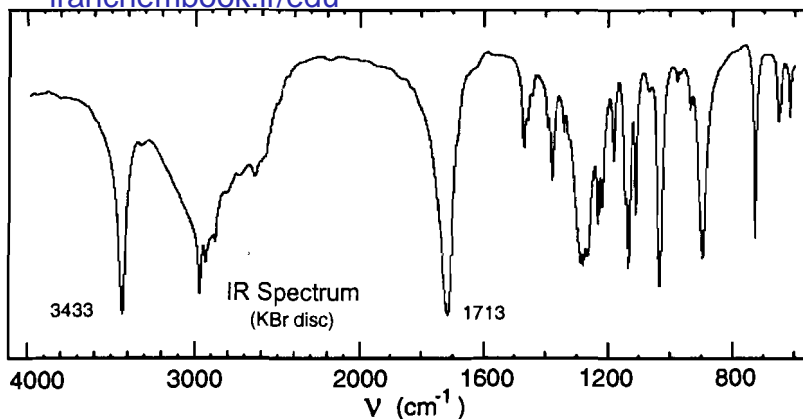

No significant UV absorption above 220 nm

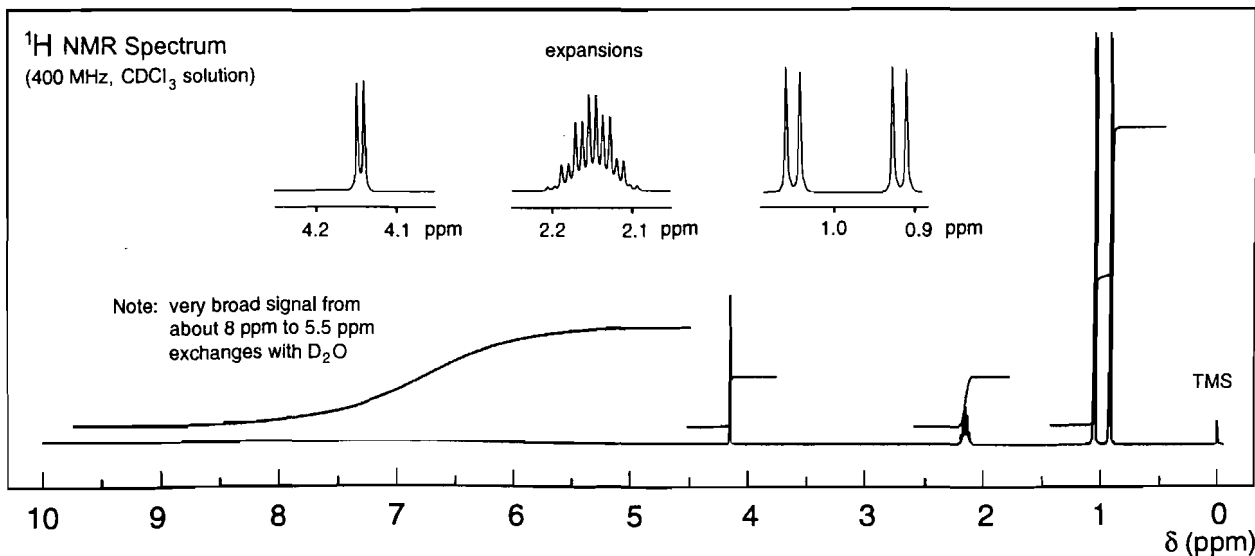
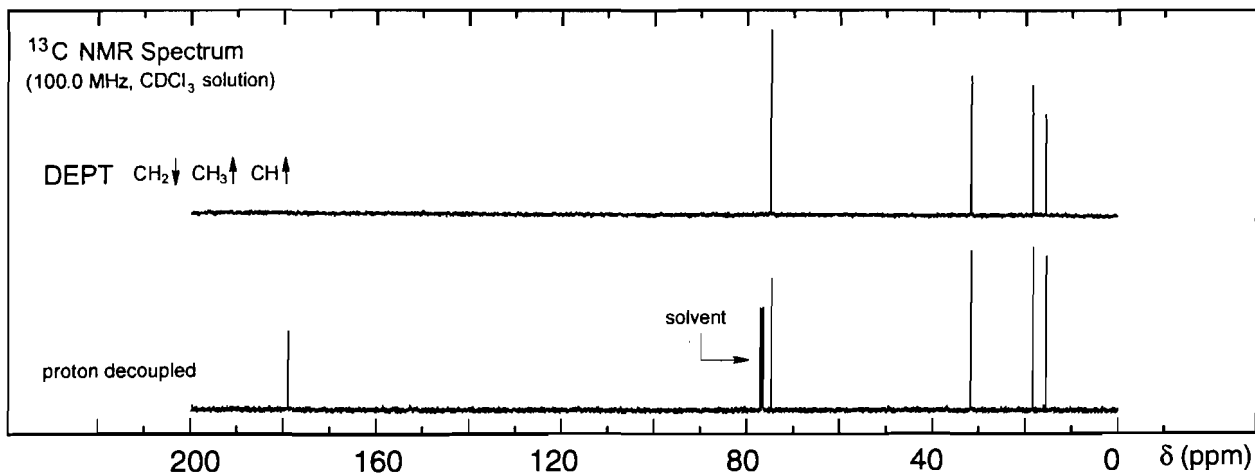



## Problem 191

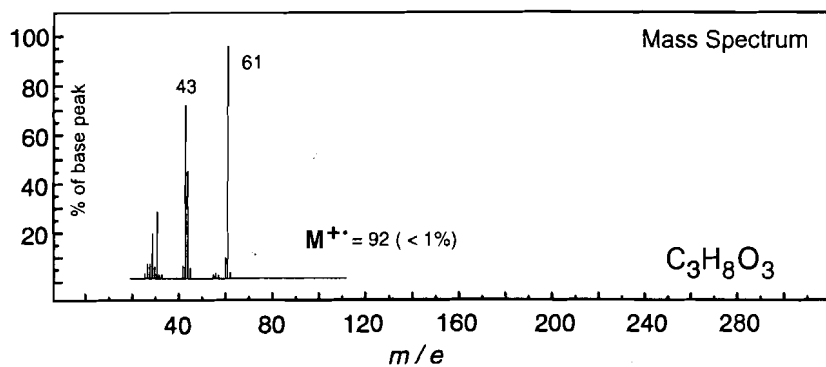
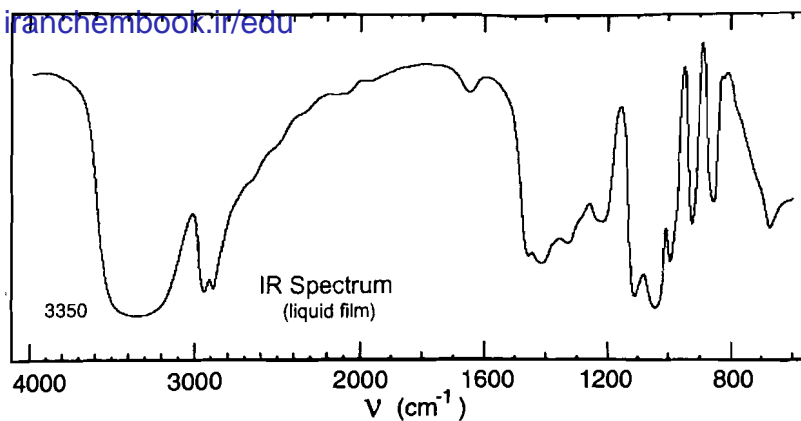

No significant UV  
absorption above 220 nm

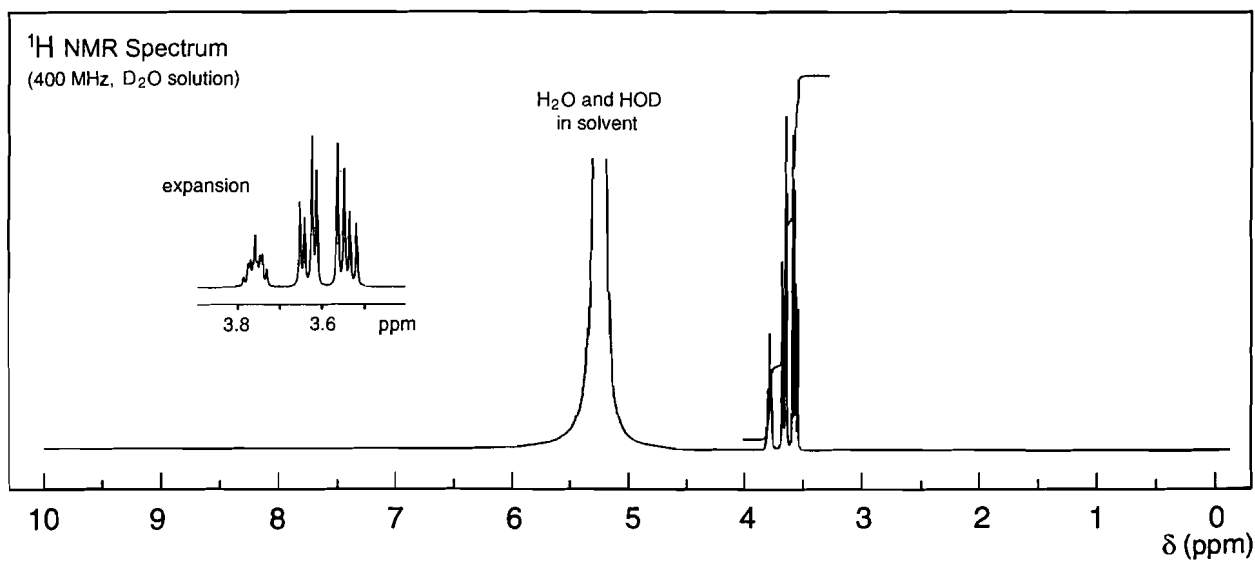
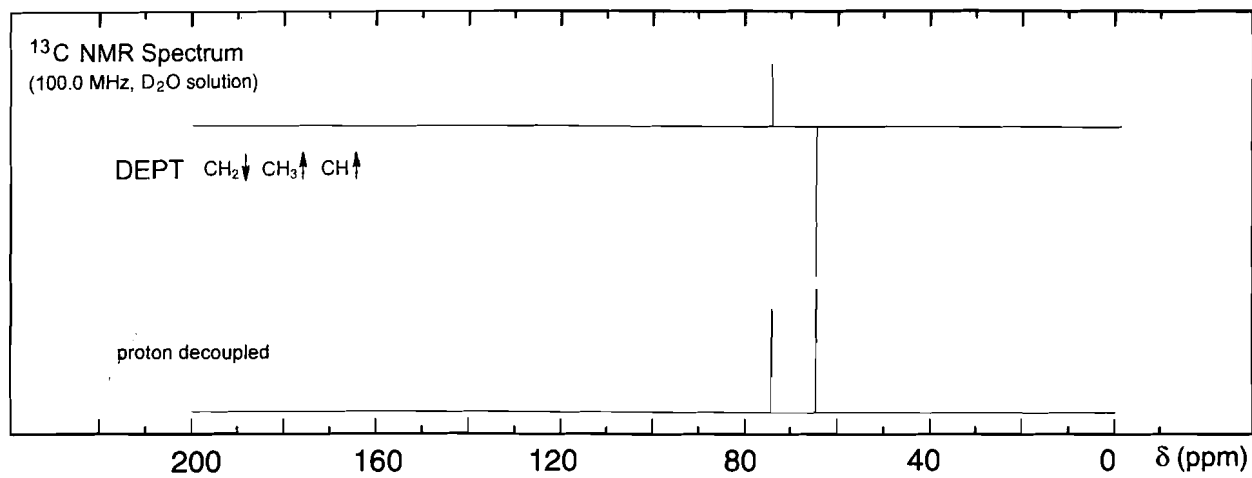

## Problem 192

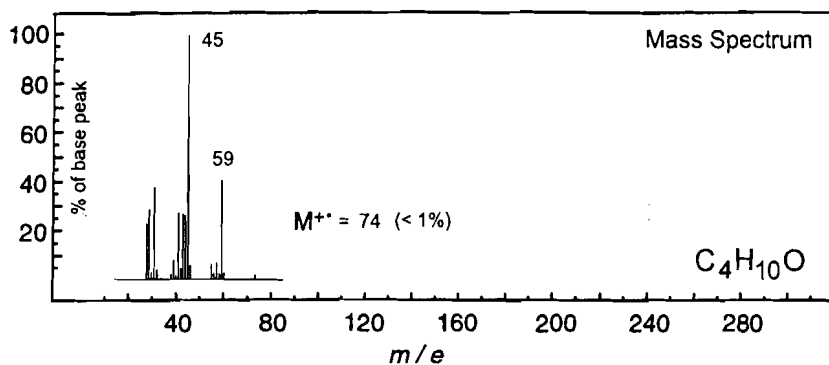
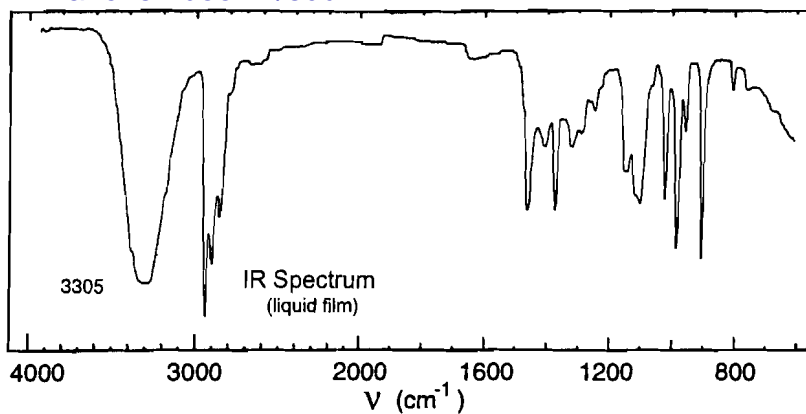

No significant UV  
absorption above 220 nm

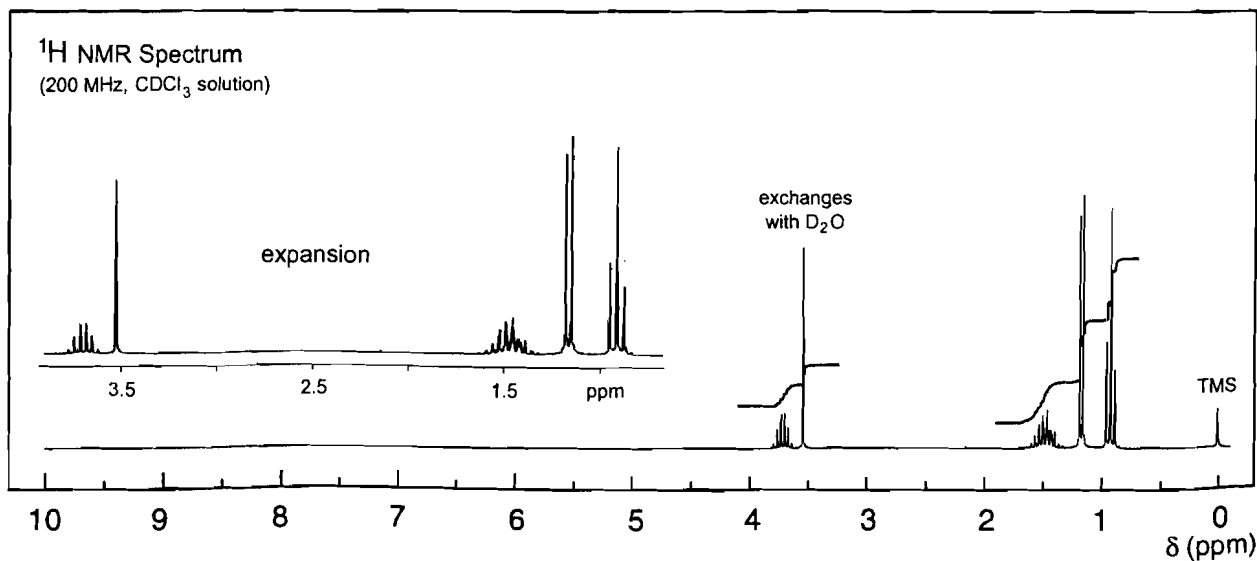
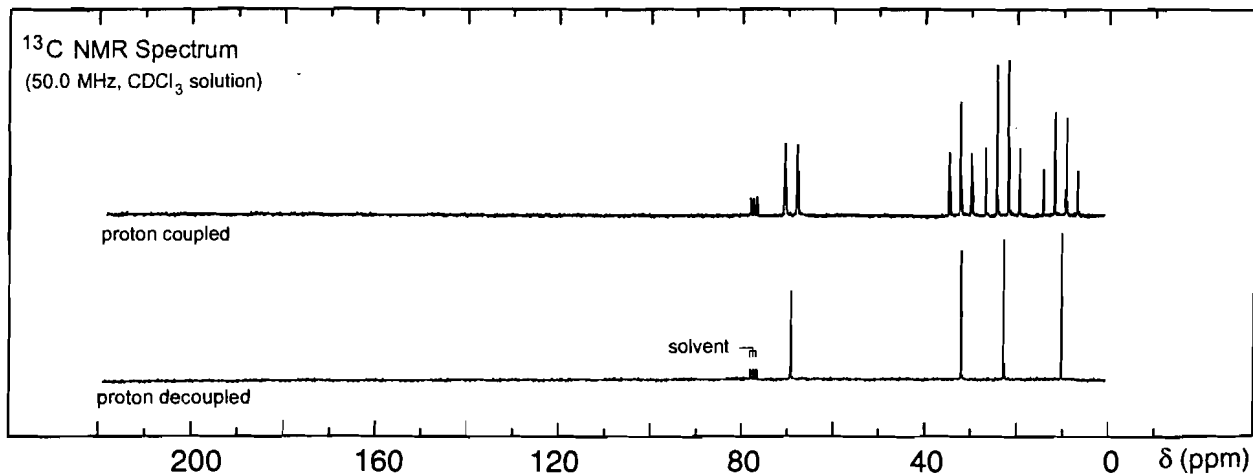

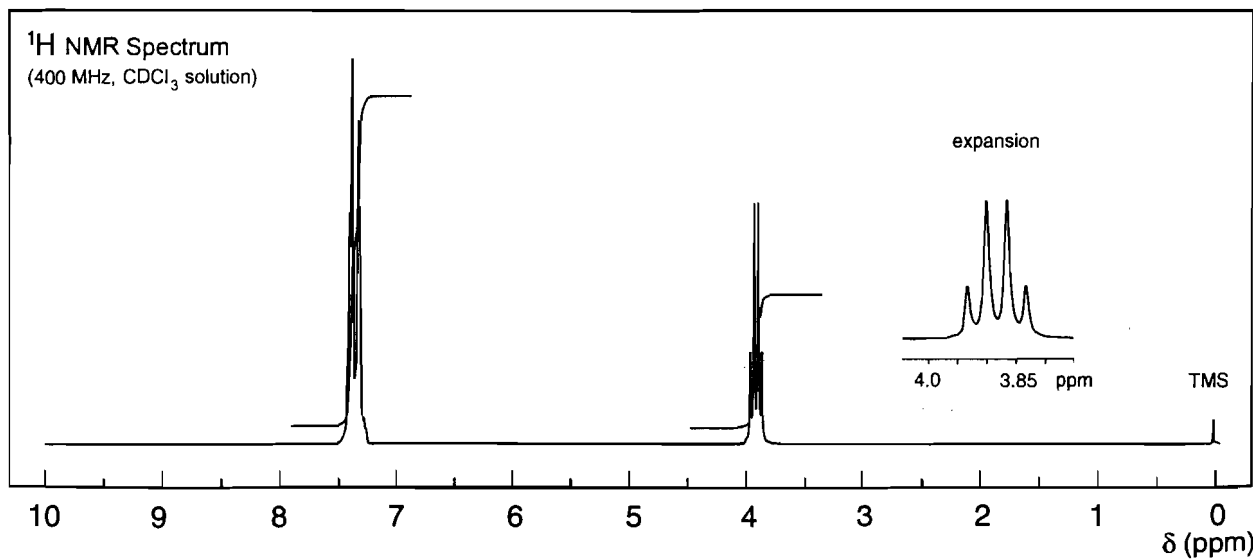
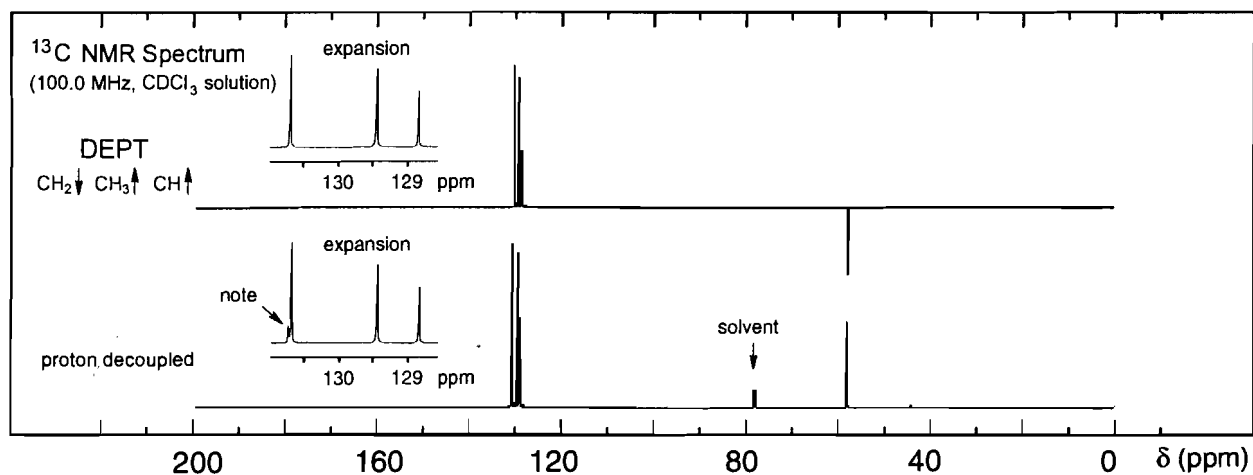
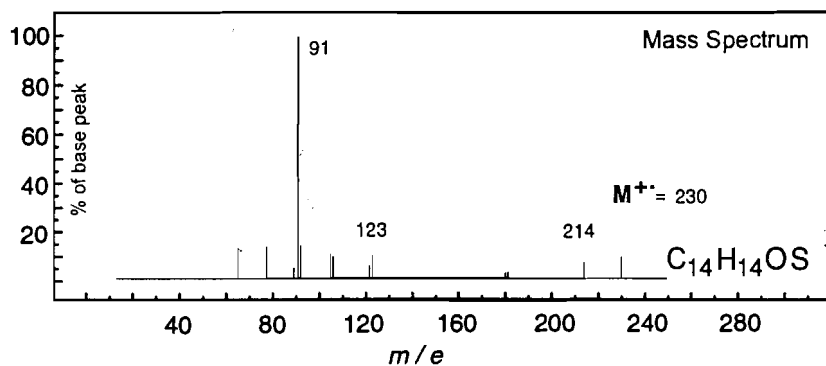
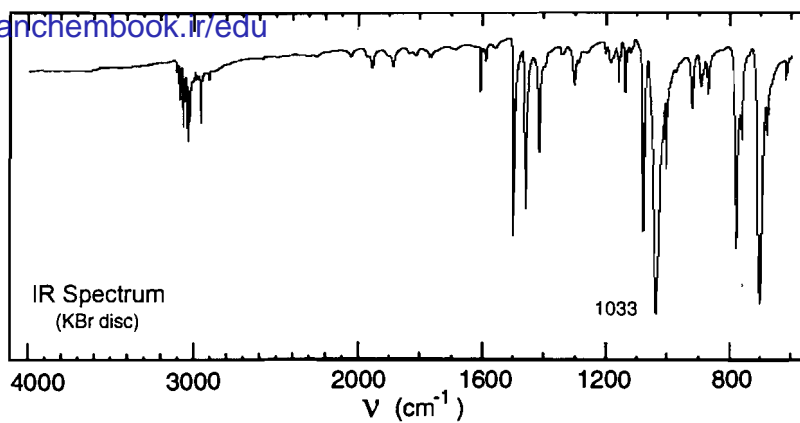

## Problem 194

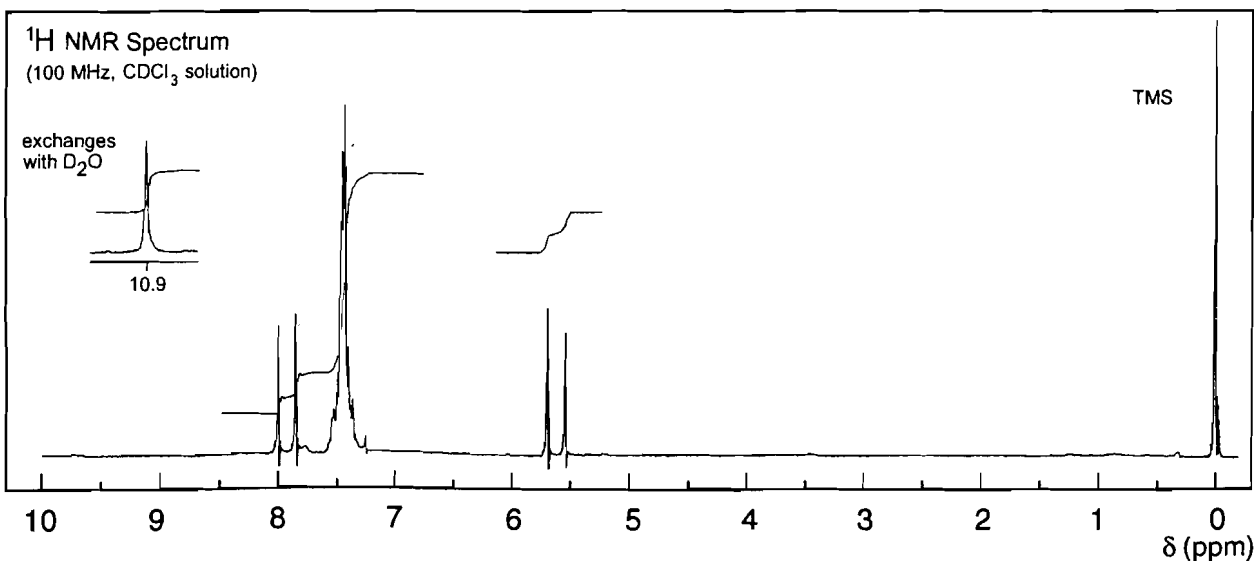
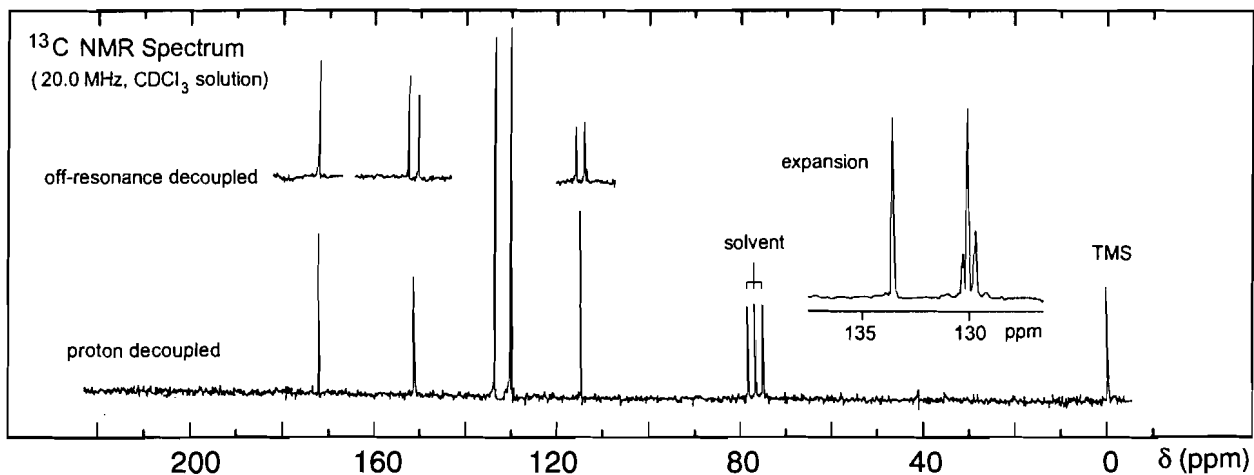
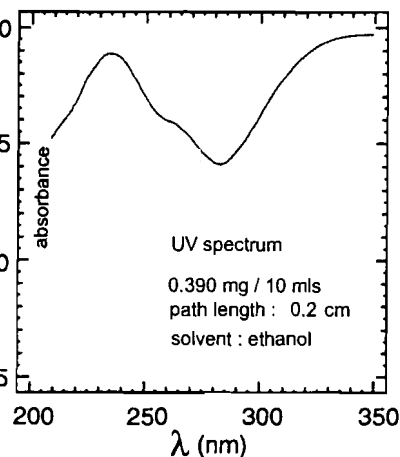
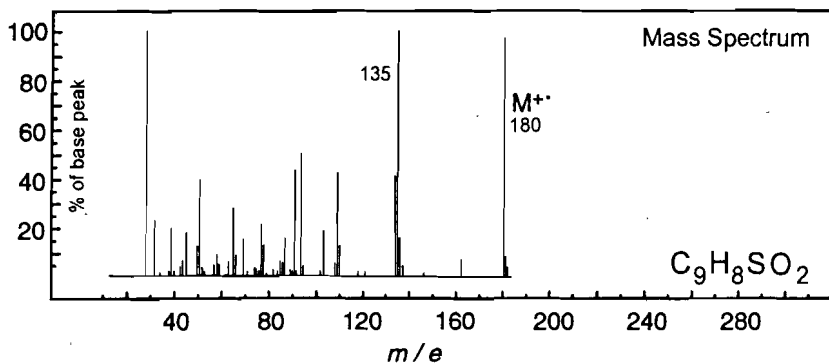
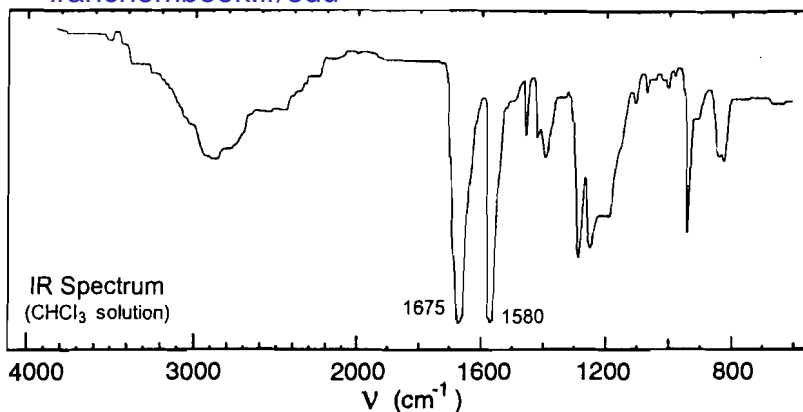

## Problem 195

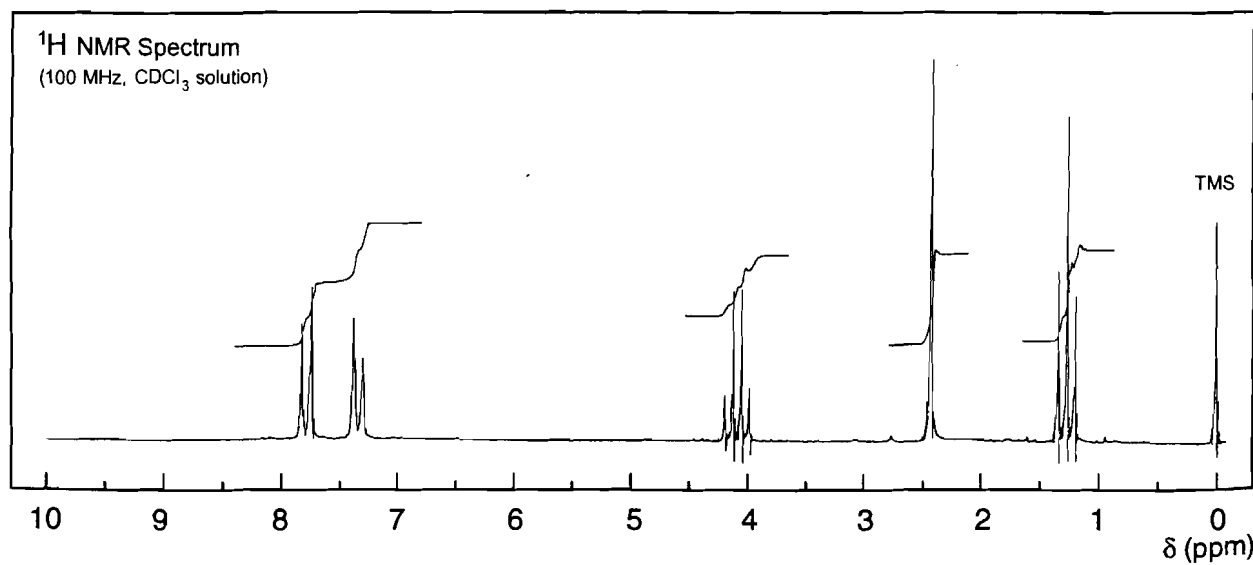
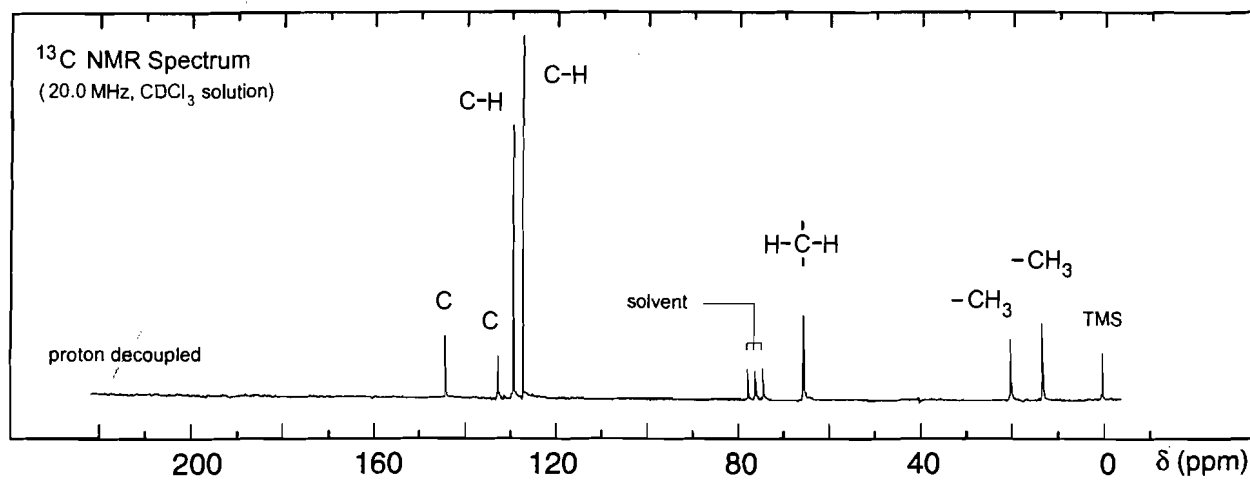
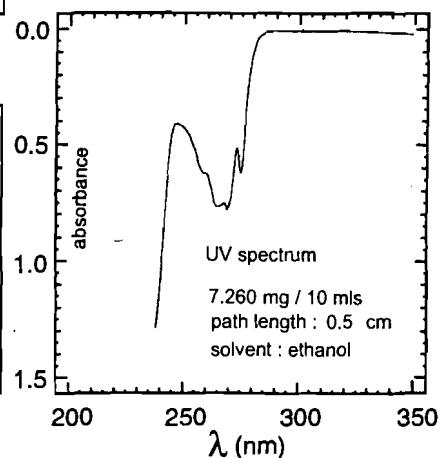
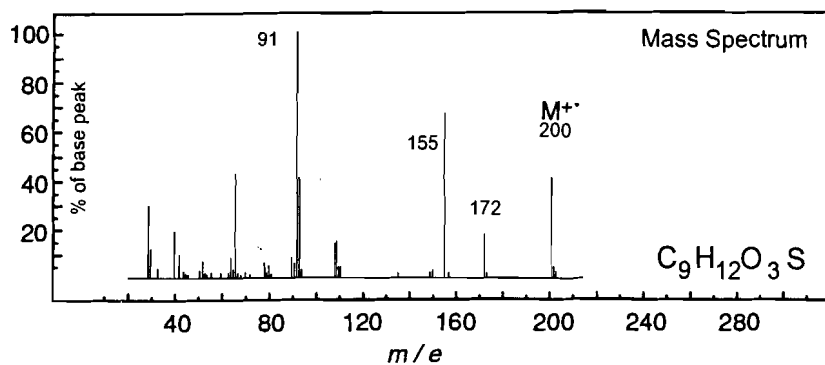
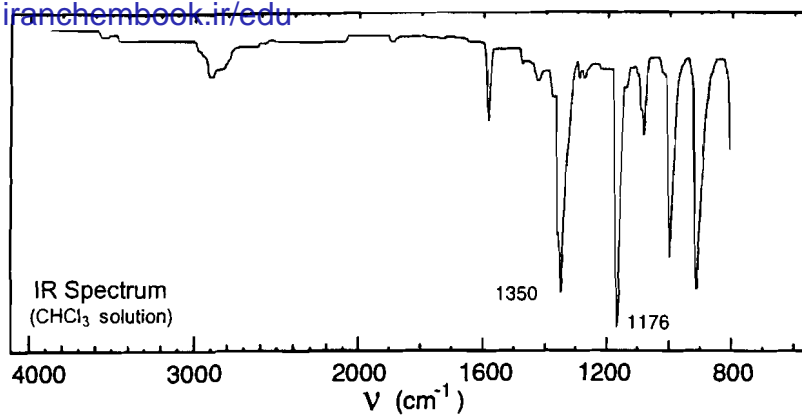

## Problem 196

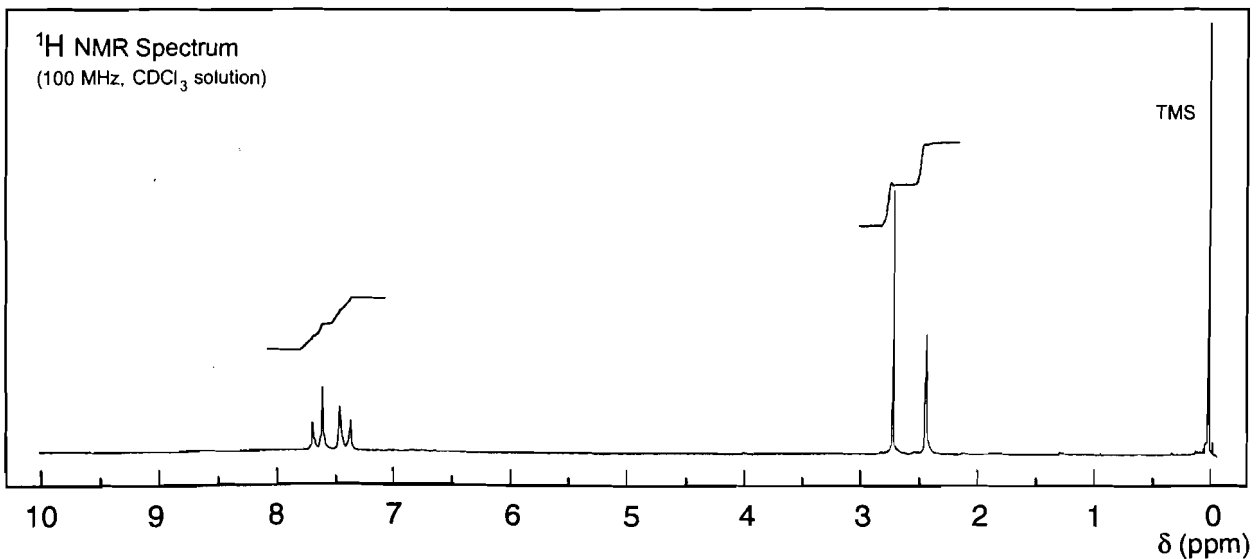
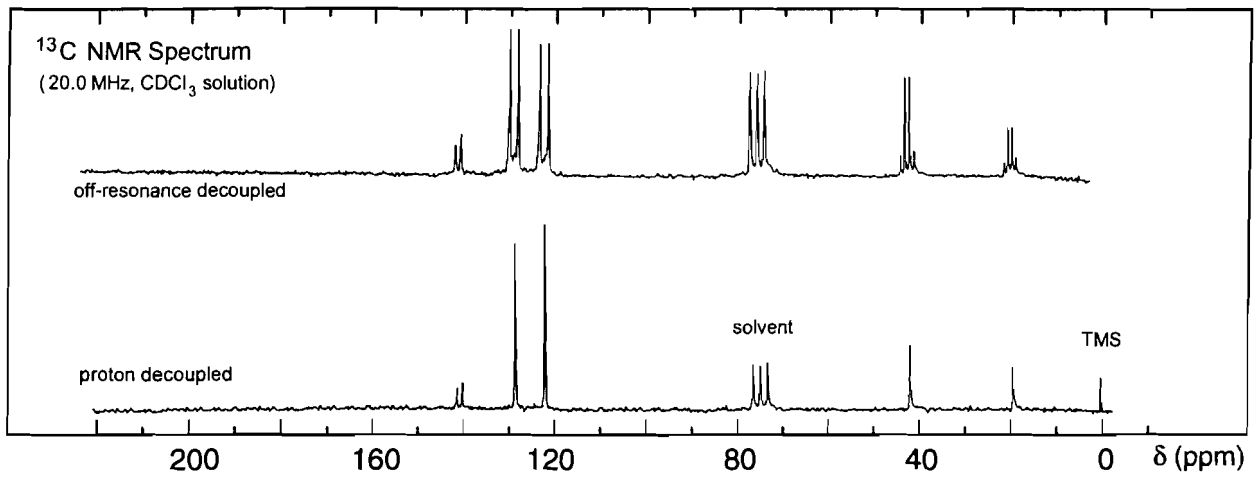
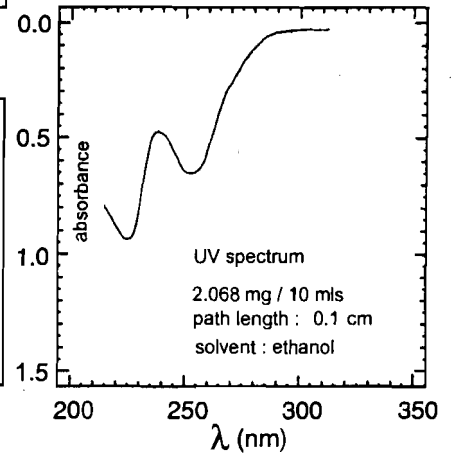
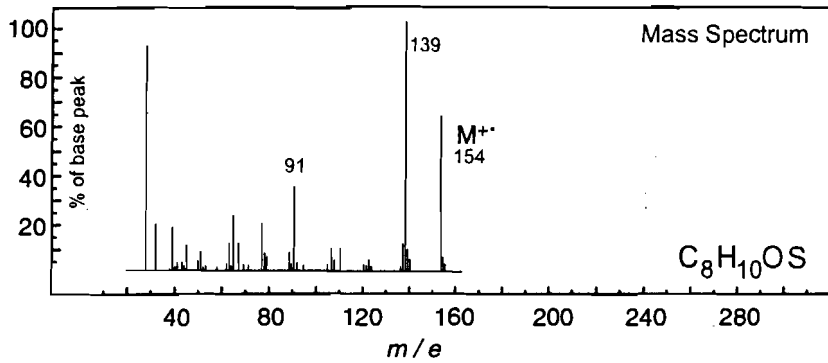
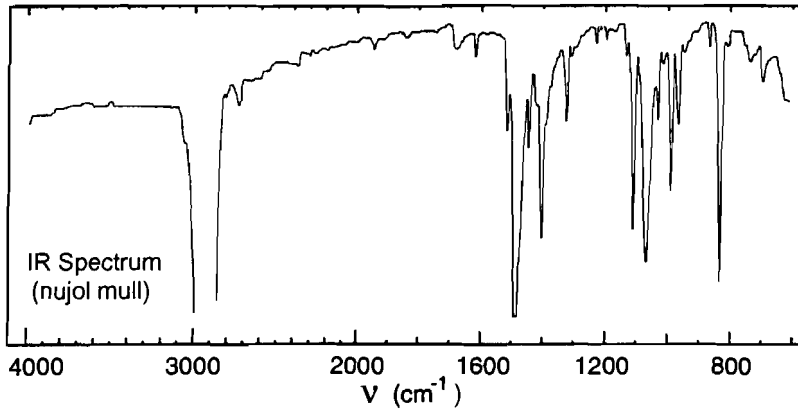

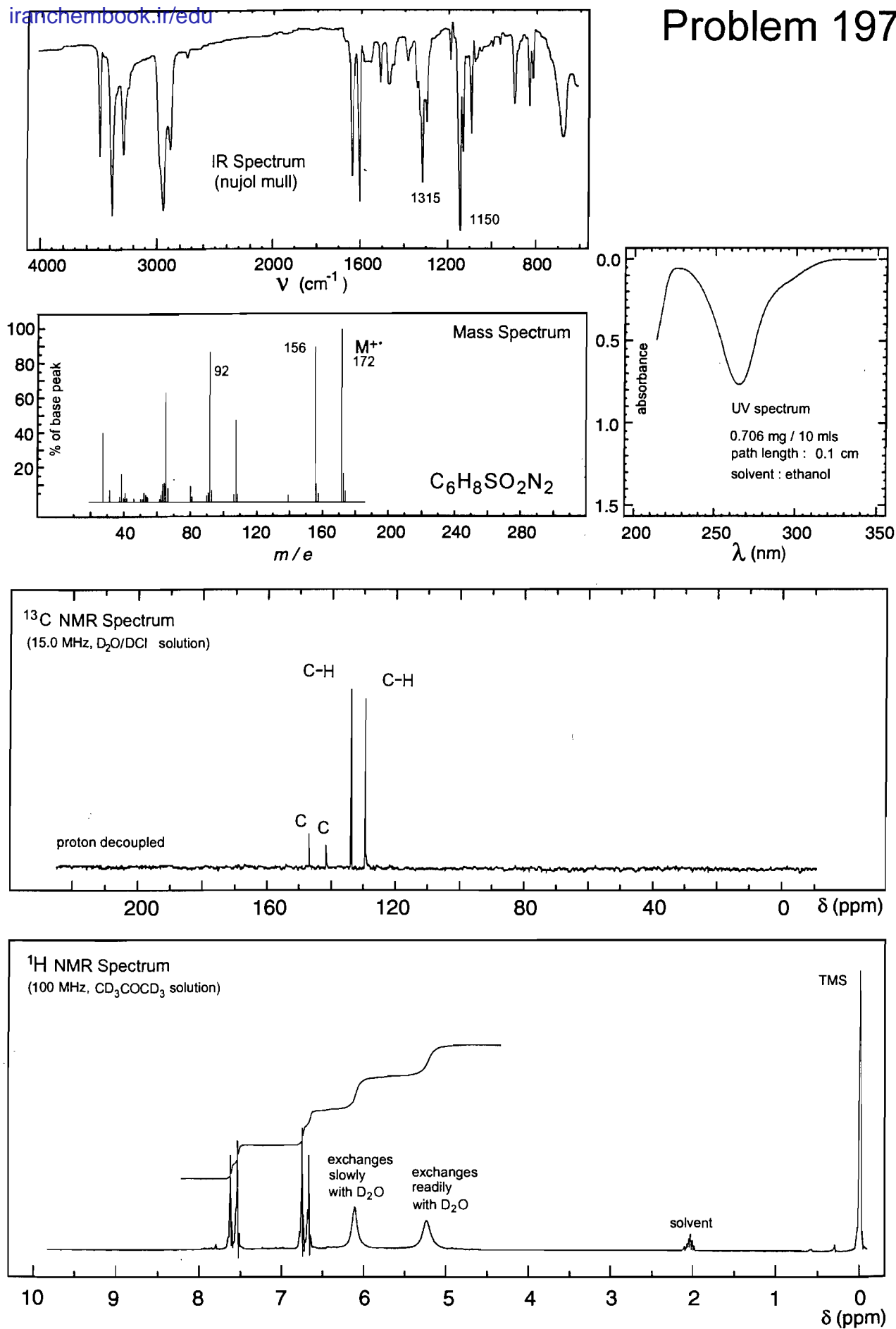

## Problem 198

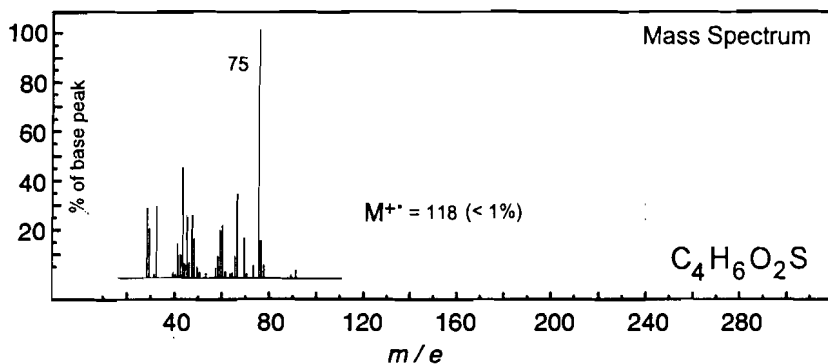
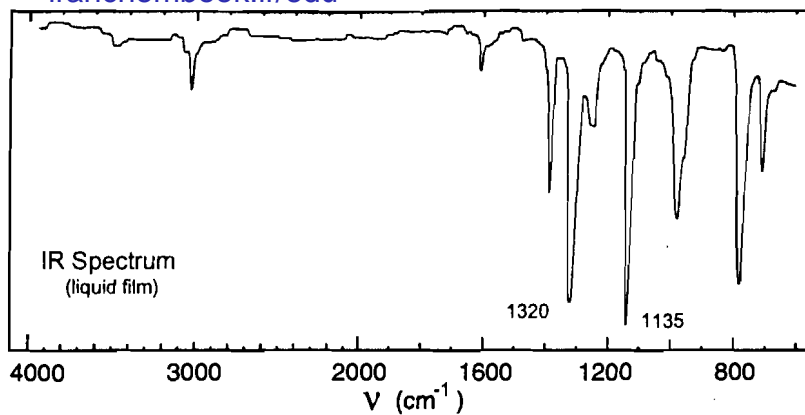

No significant UV  
absorption above 220 nm

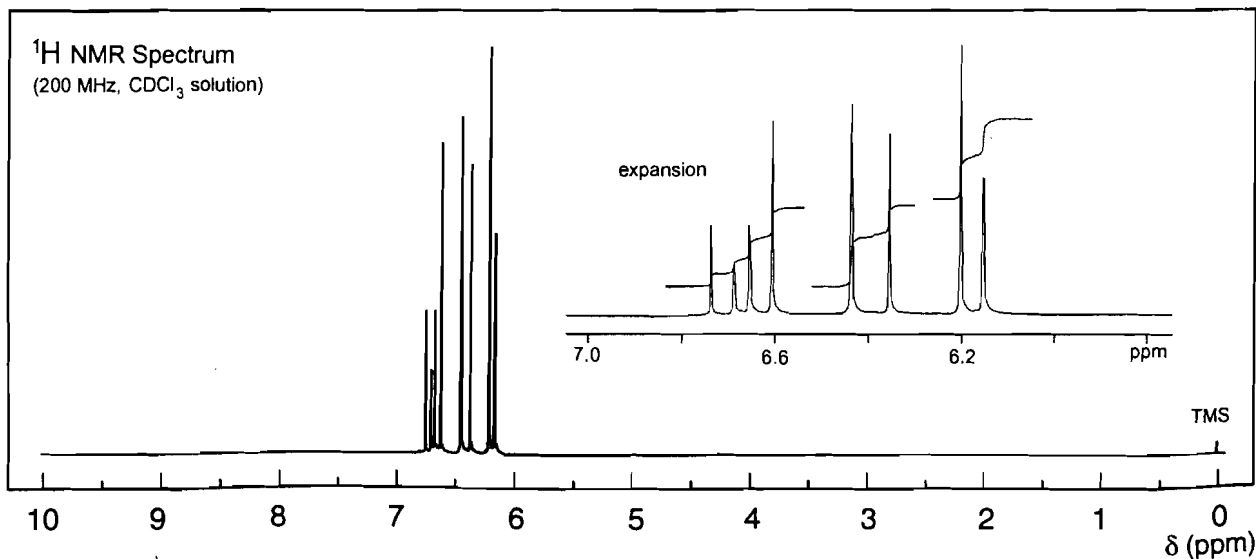
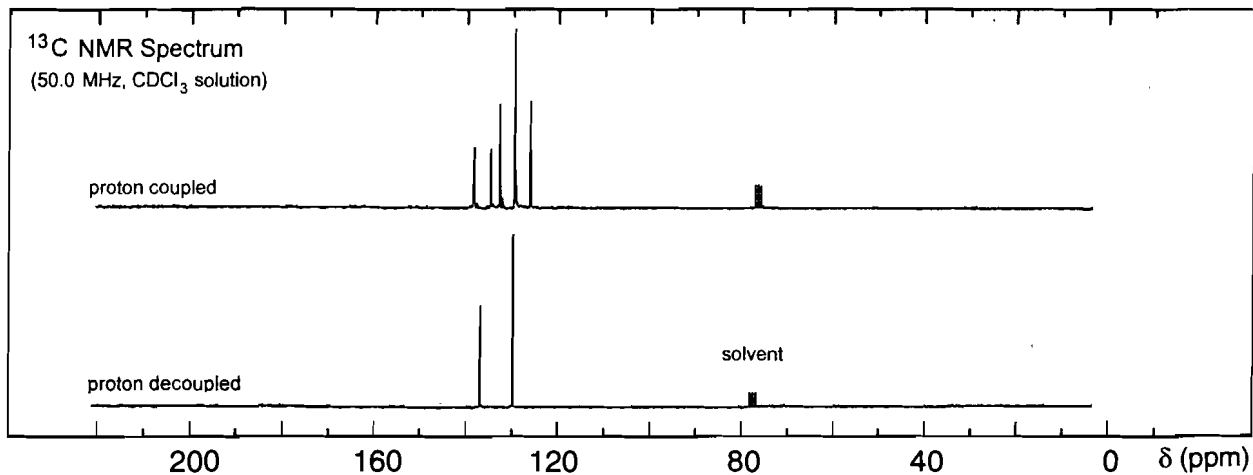



## Problem 199

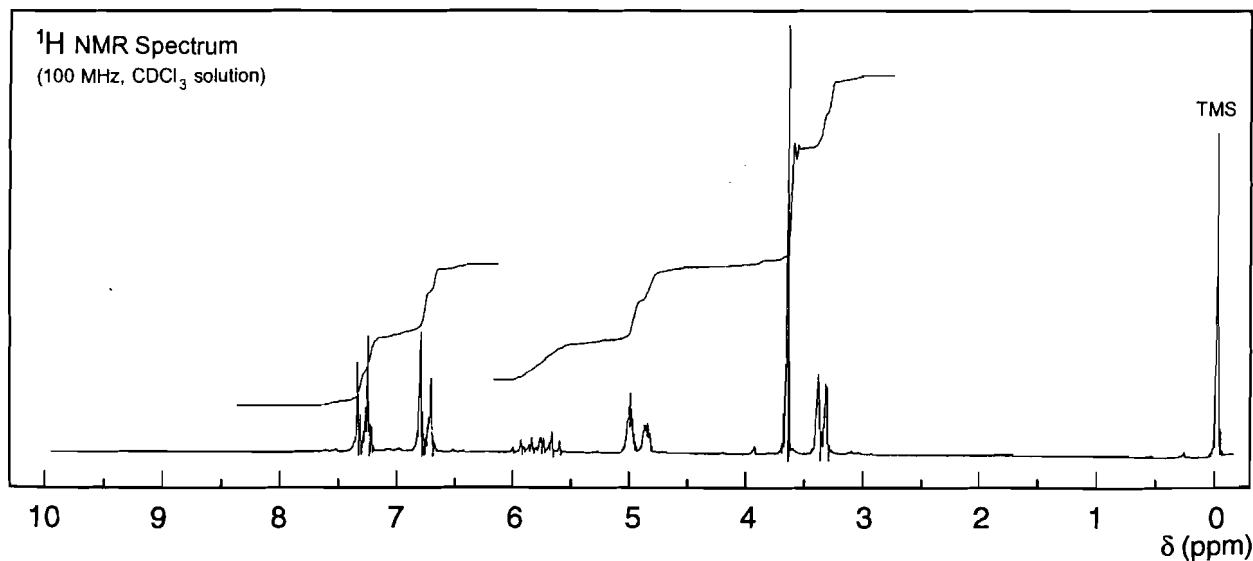
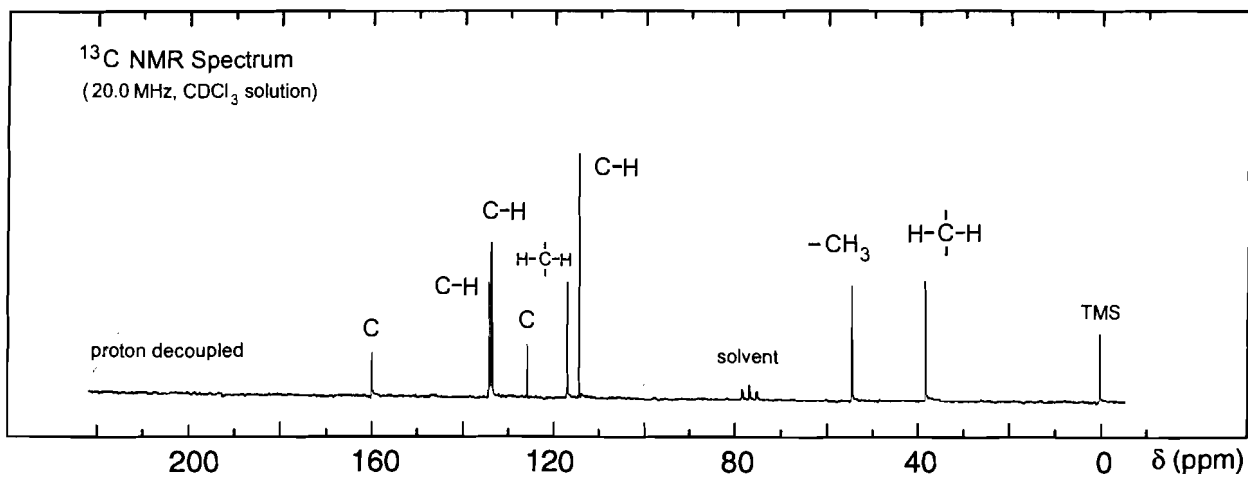
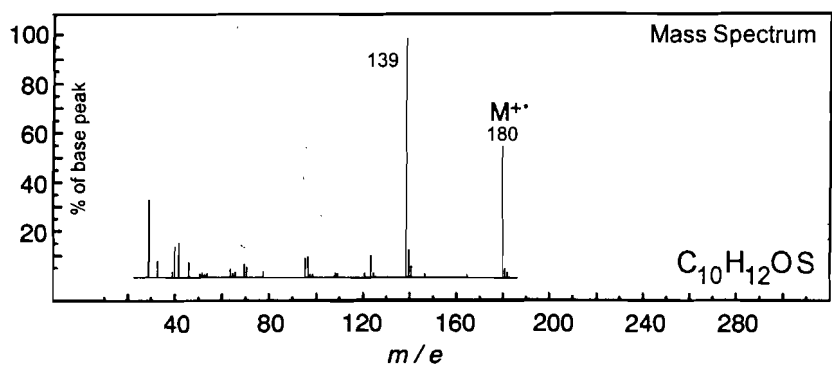
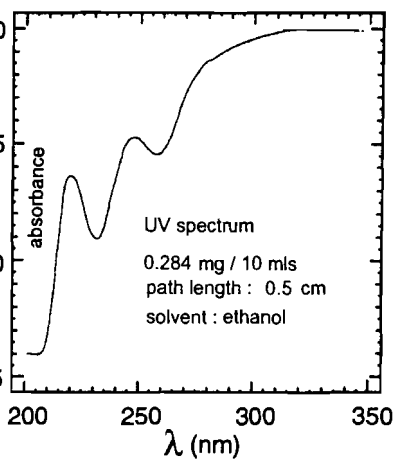
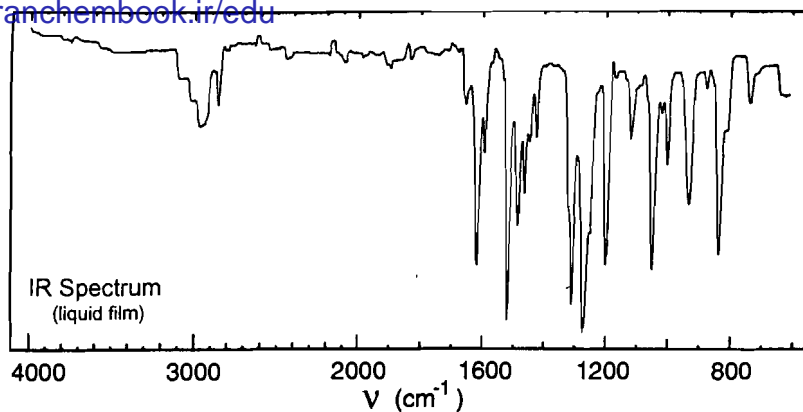

# Problem 200

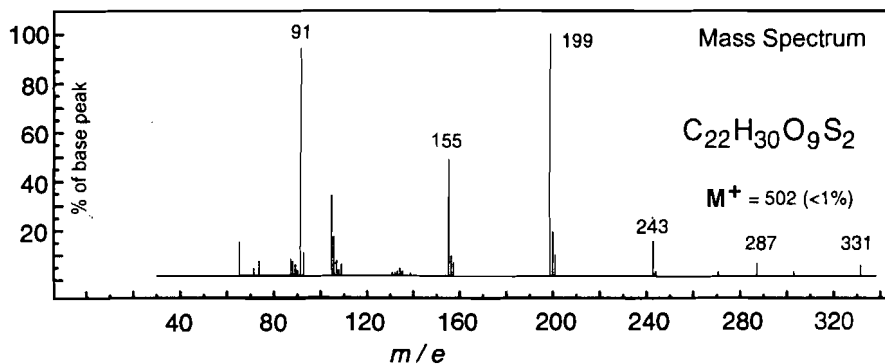
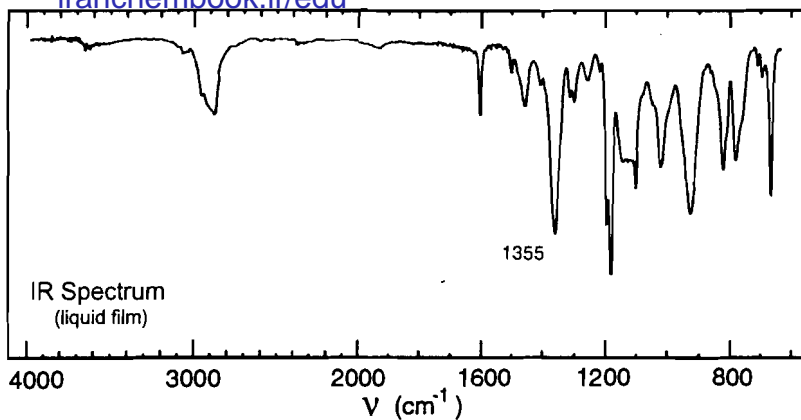

## UV Spectrum

$\lambda_{\max}$  225 nm ( $\log_{10} \epsilon$  4.6)

$\lambda_{\max}$  260 nm ( $\log_{10} \epsilon$  3.3)

$\lambda_{\max}$  272 nm ( $\log_{10} \epsilon$  3.1)

solvent: methanol

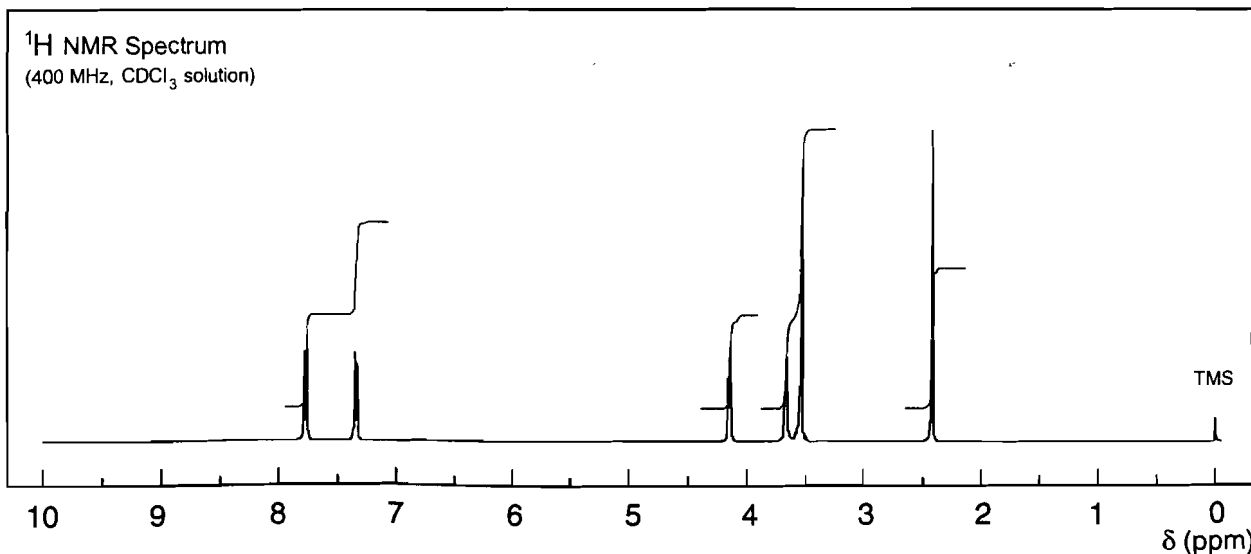
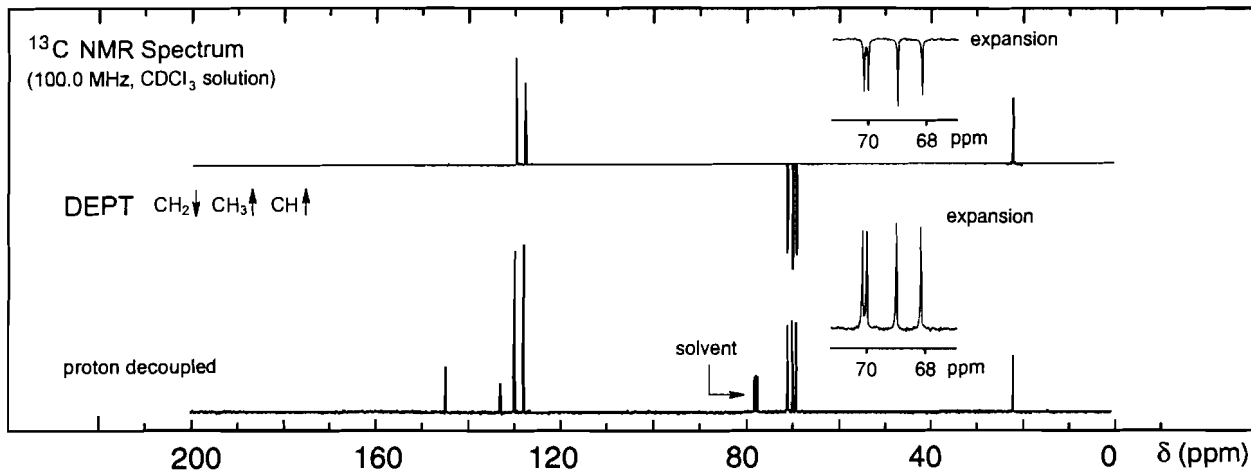

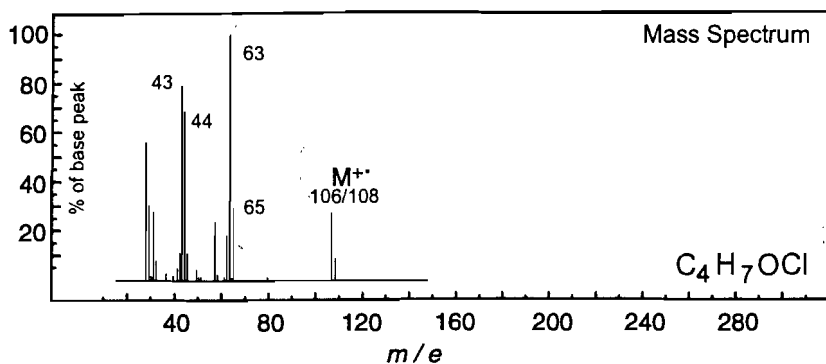
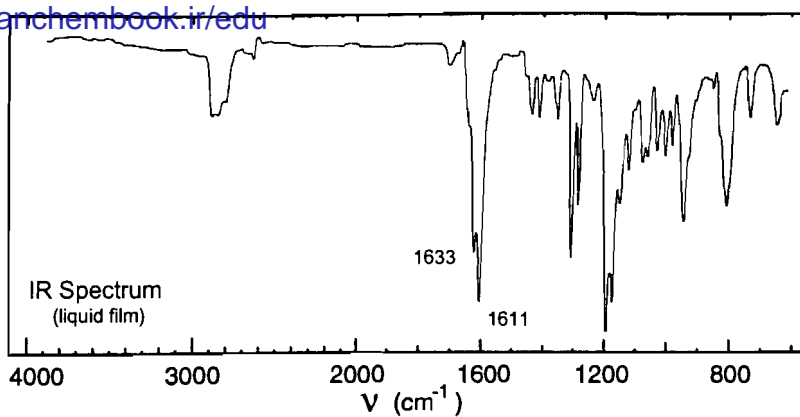

No significant UV  
absorption above 220 nm

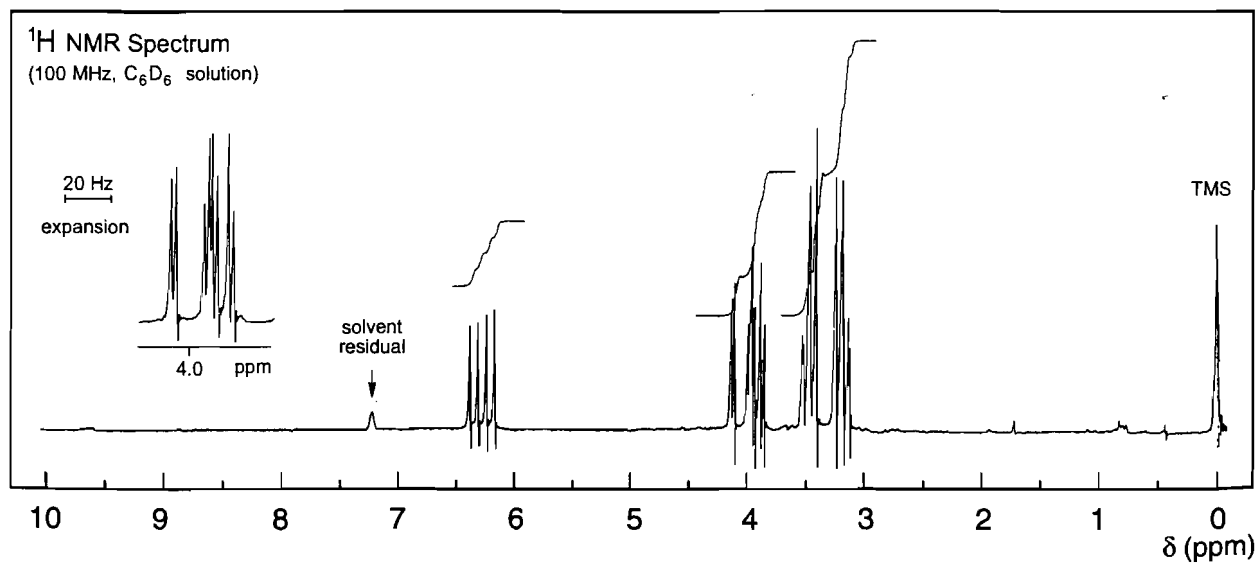
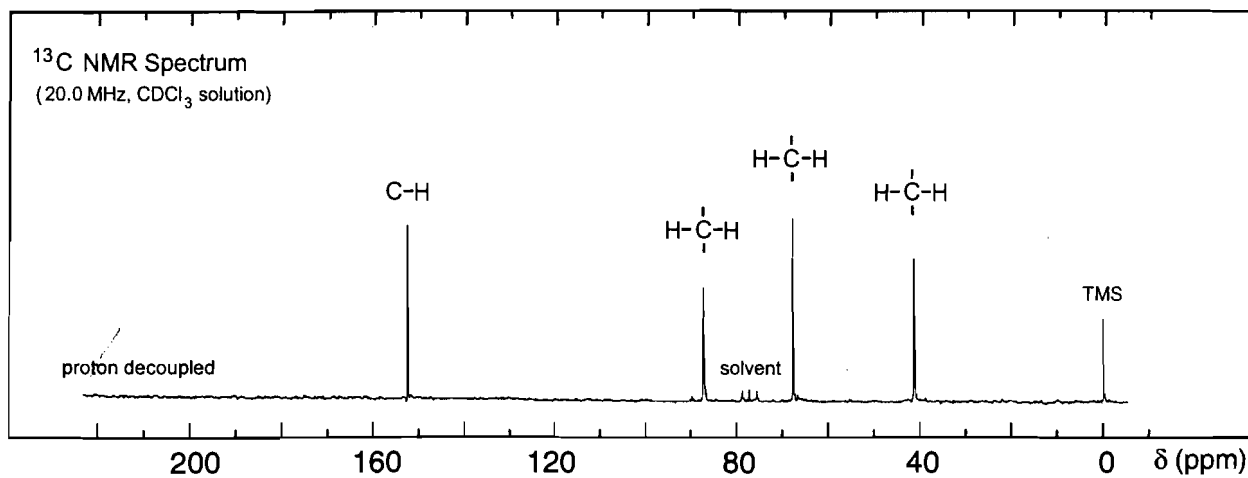

## Problem 202

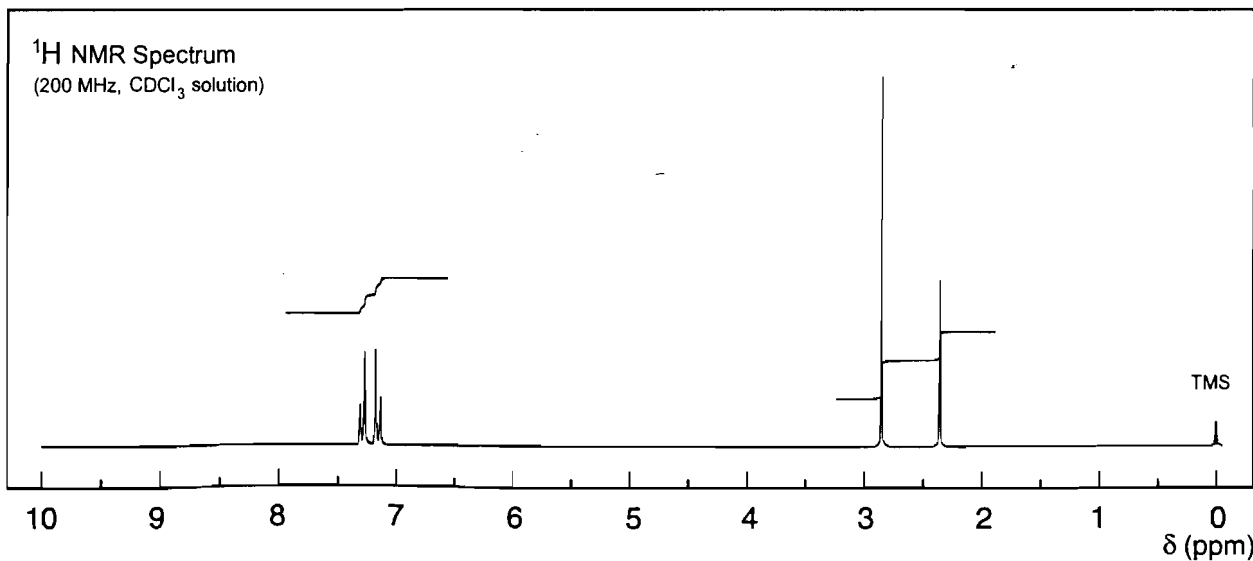
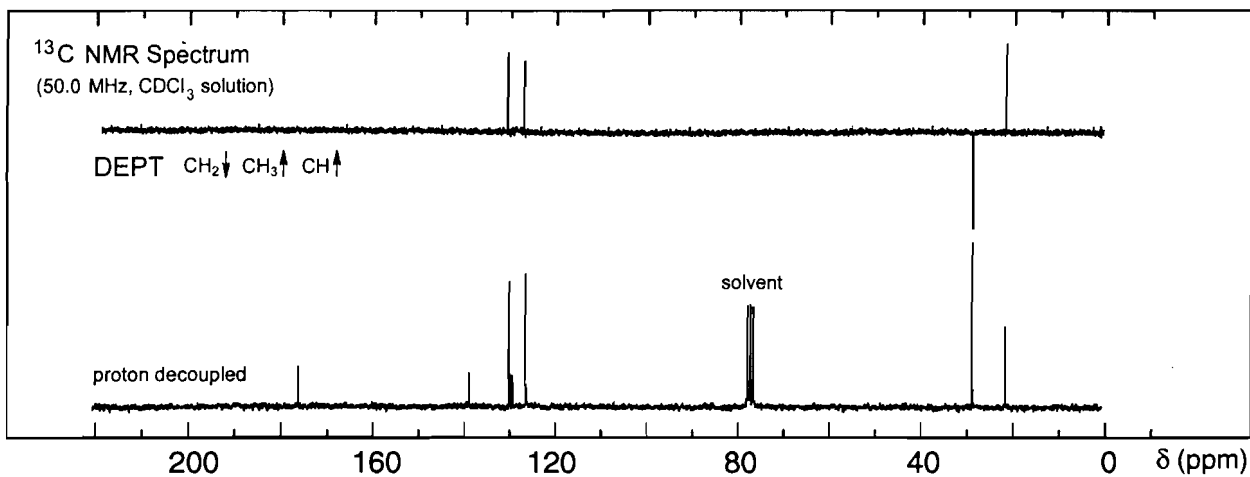
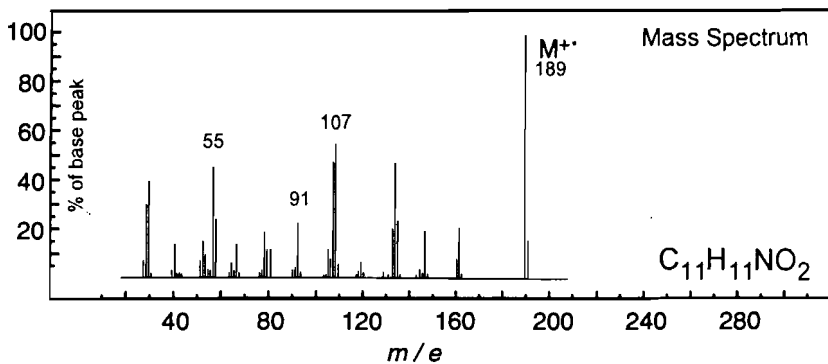
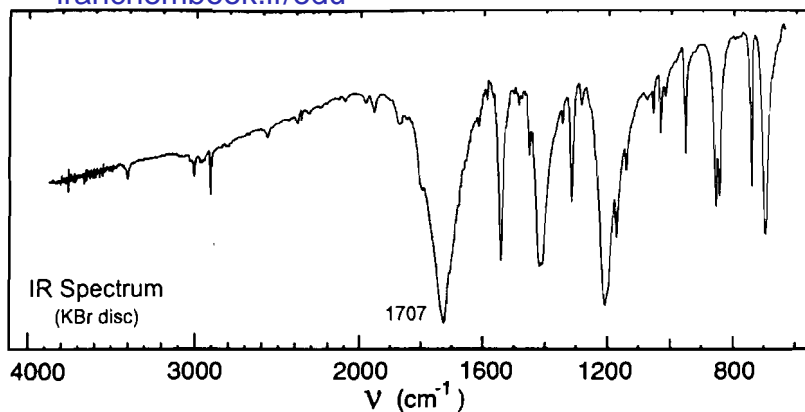

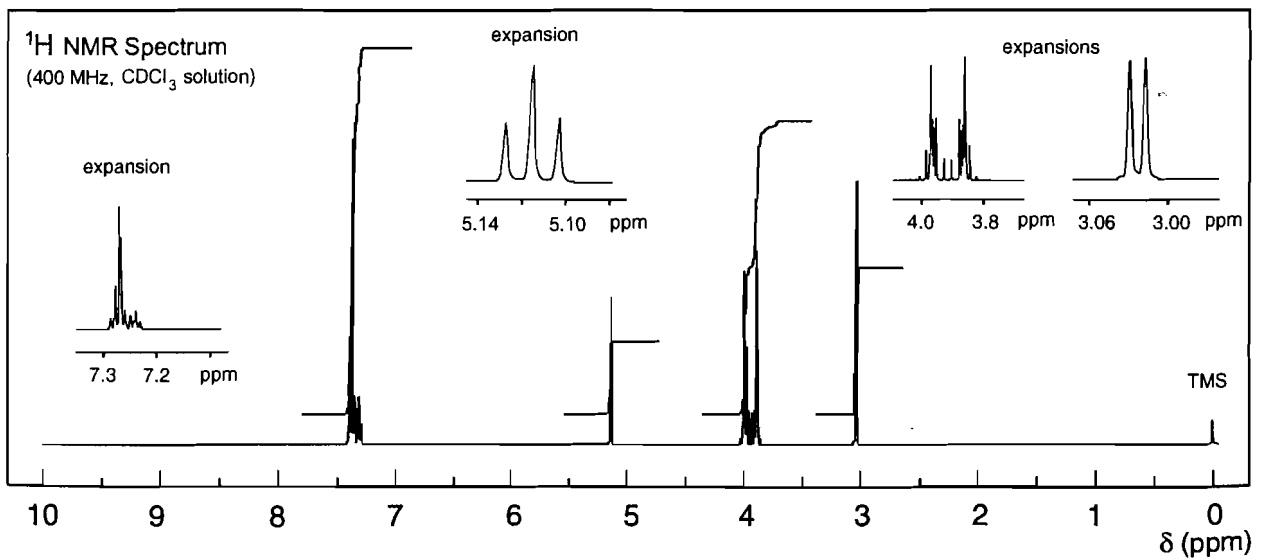
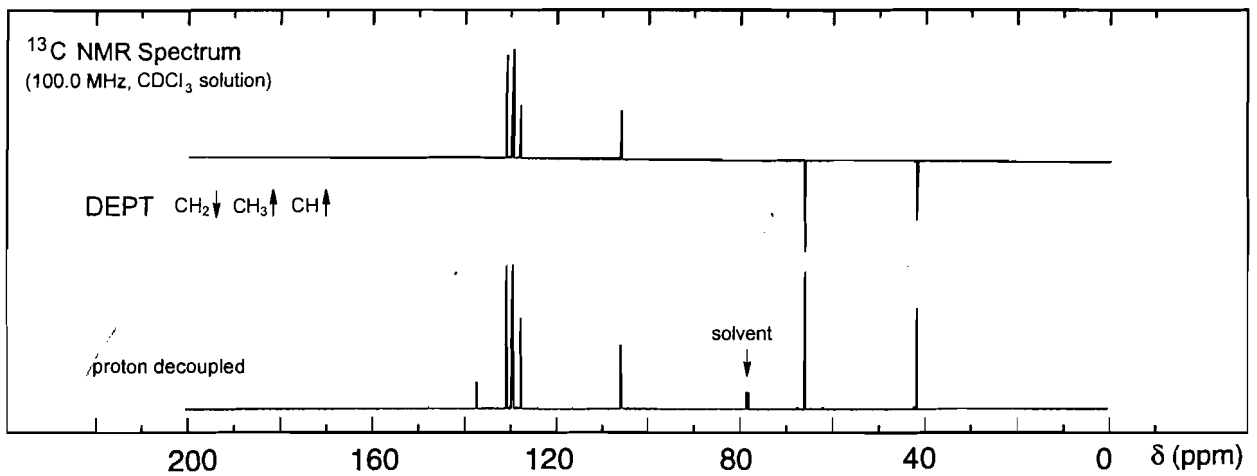
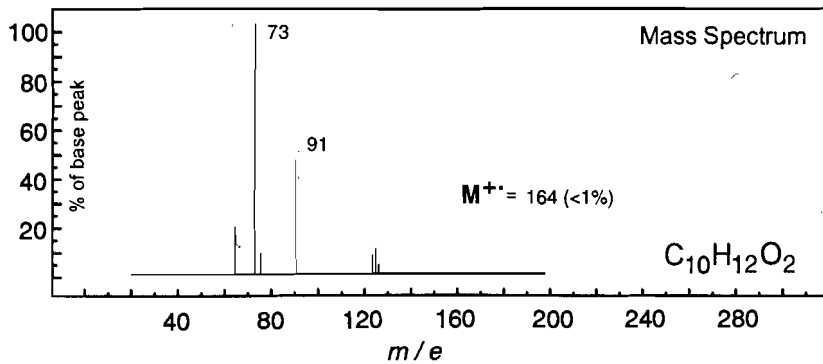
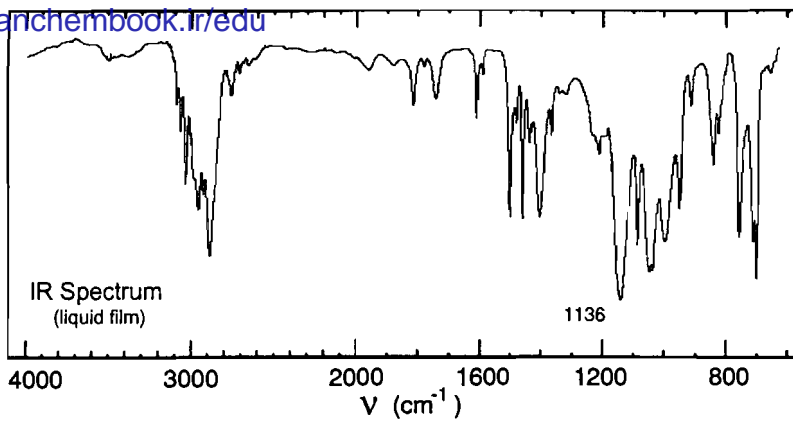

## Problem 204

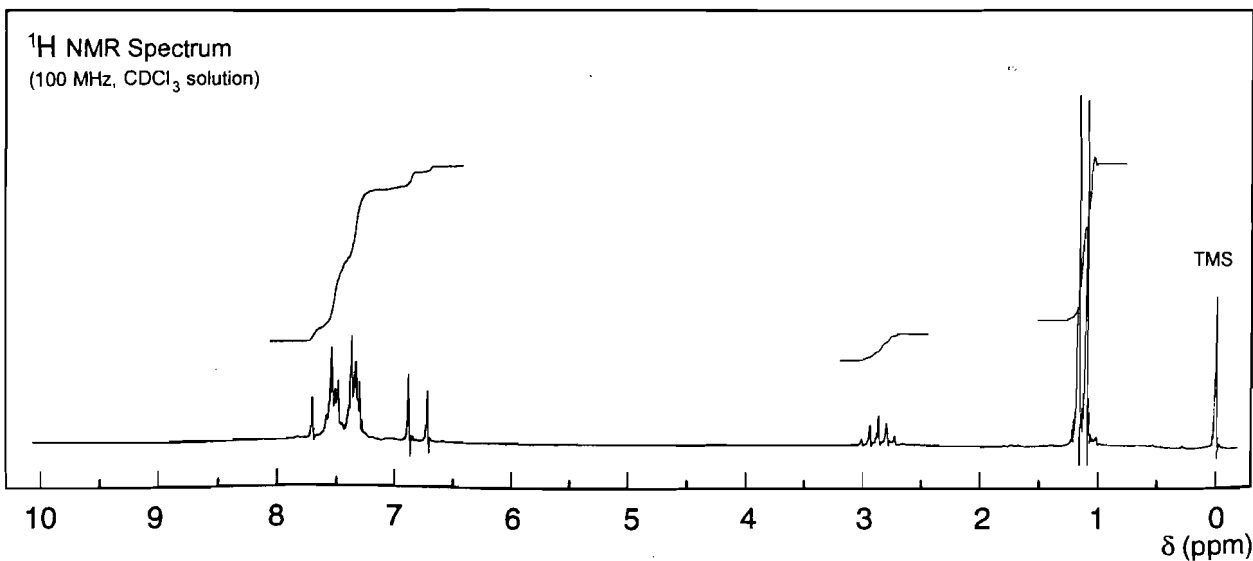
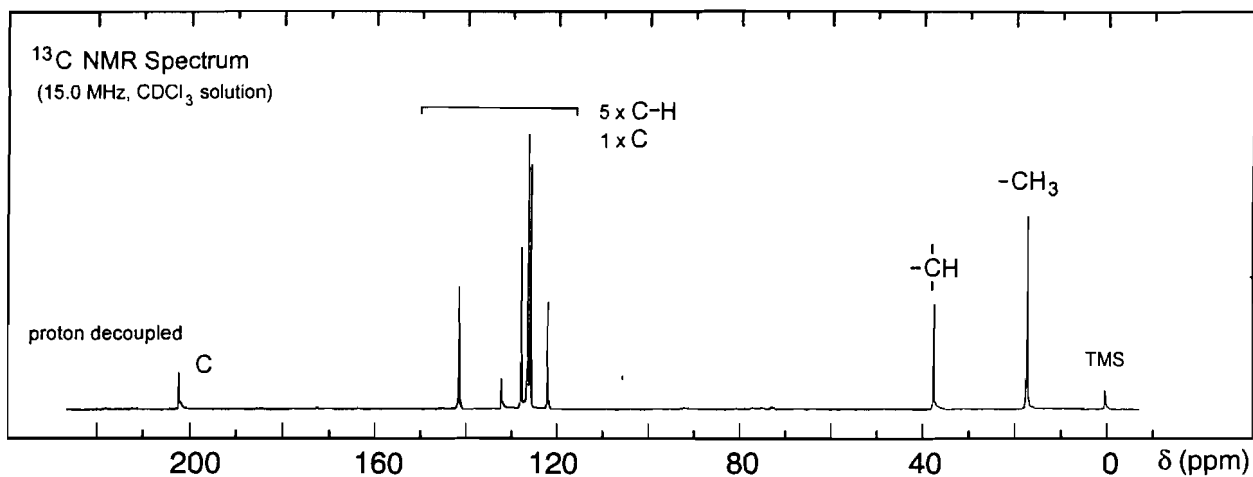
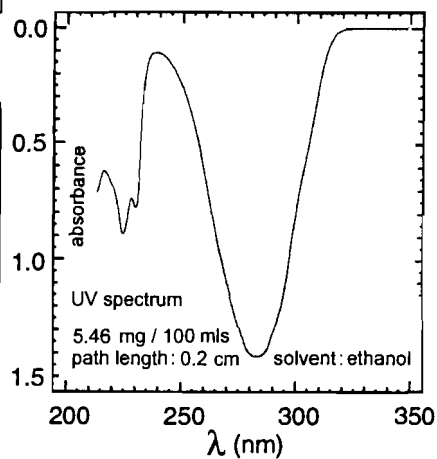
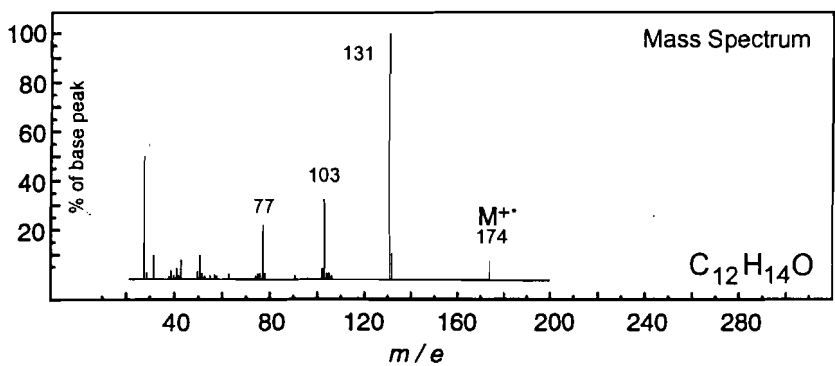
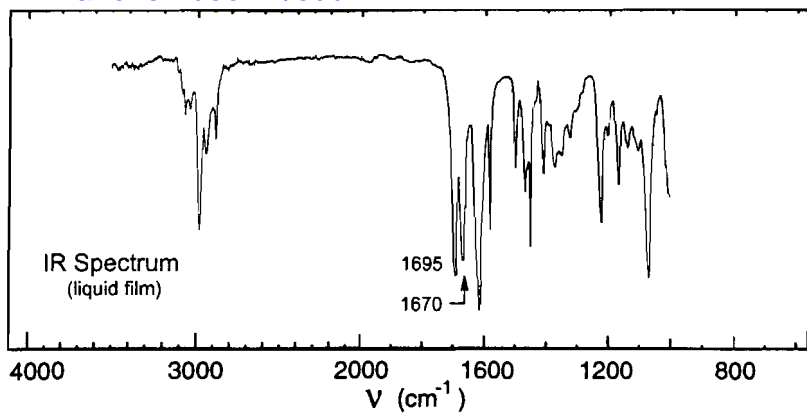

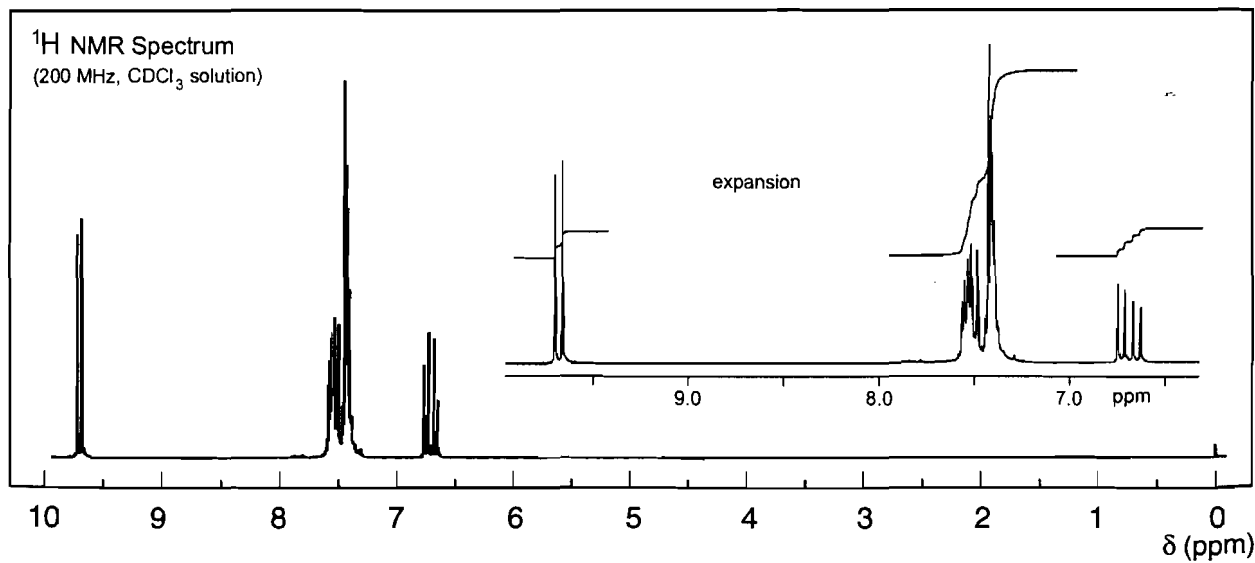
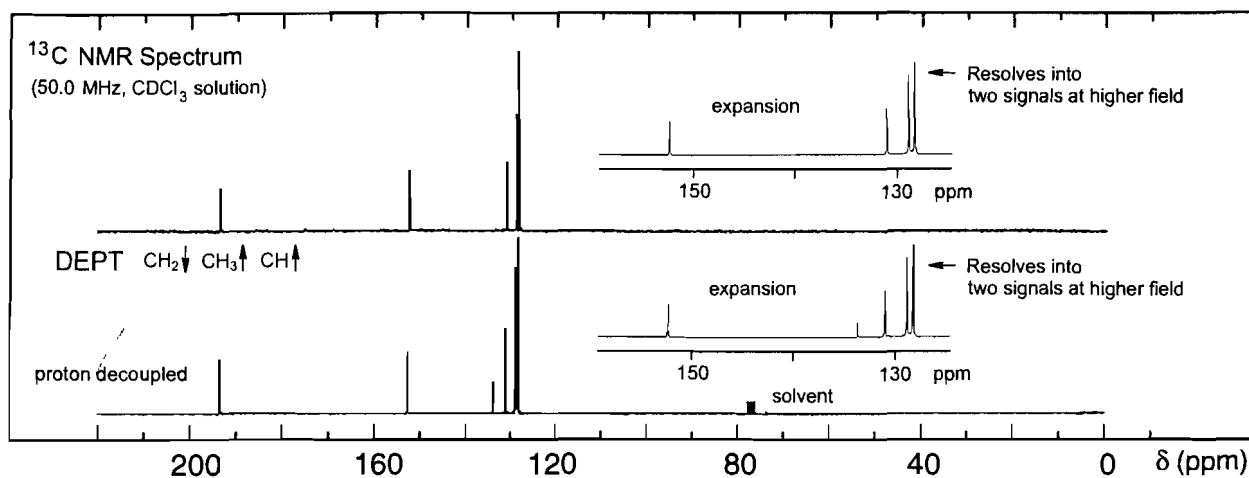
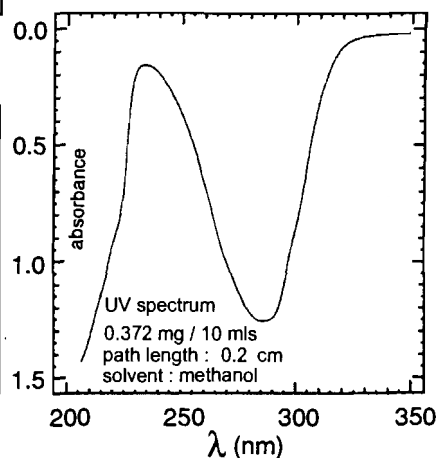
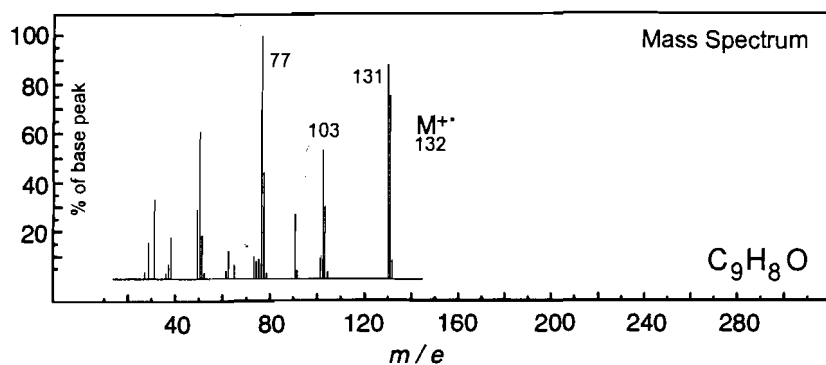
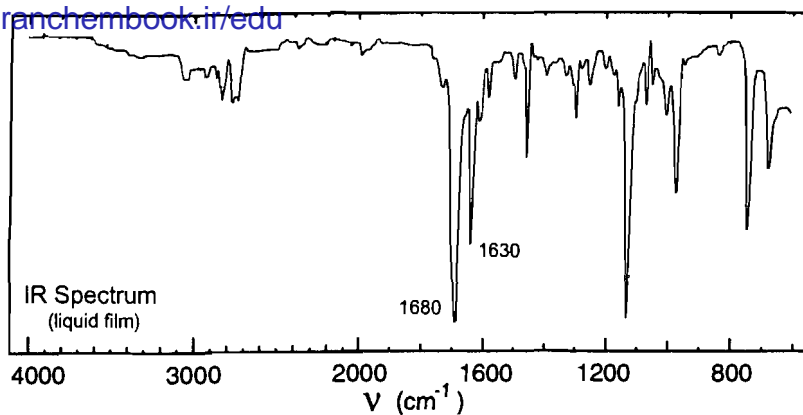

## Problem 206

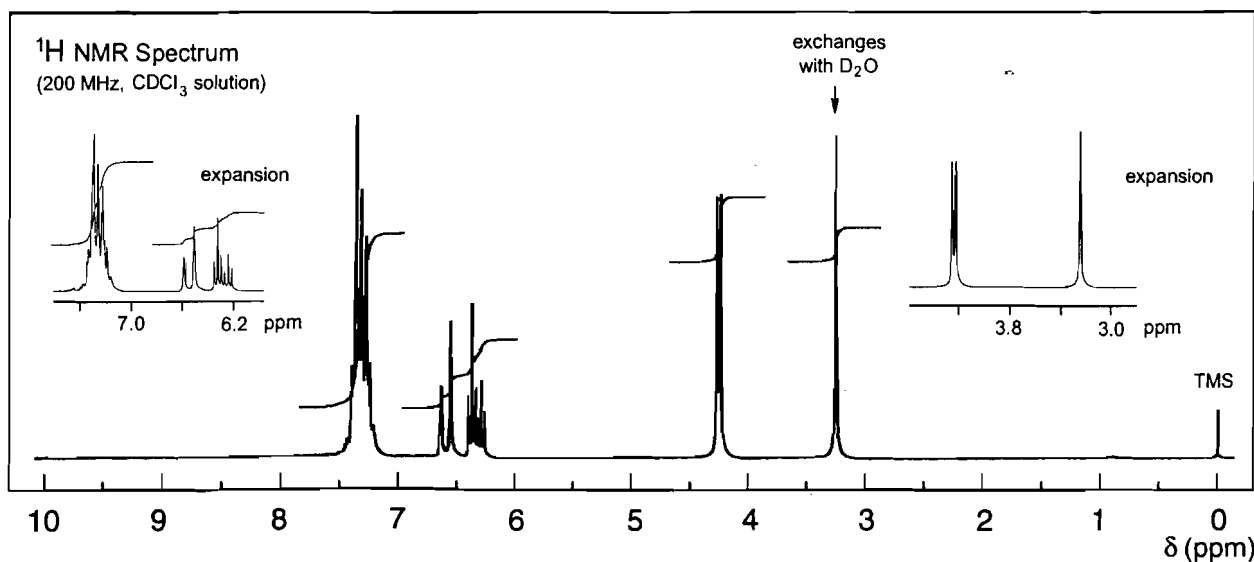
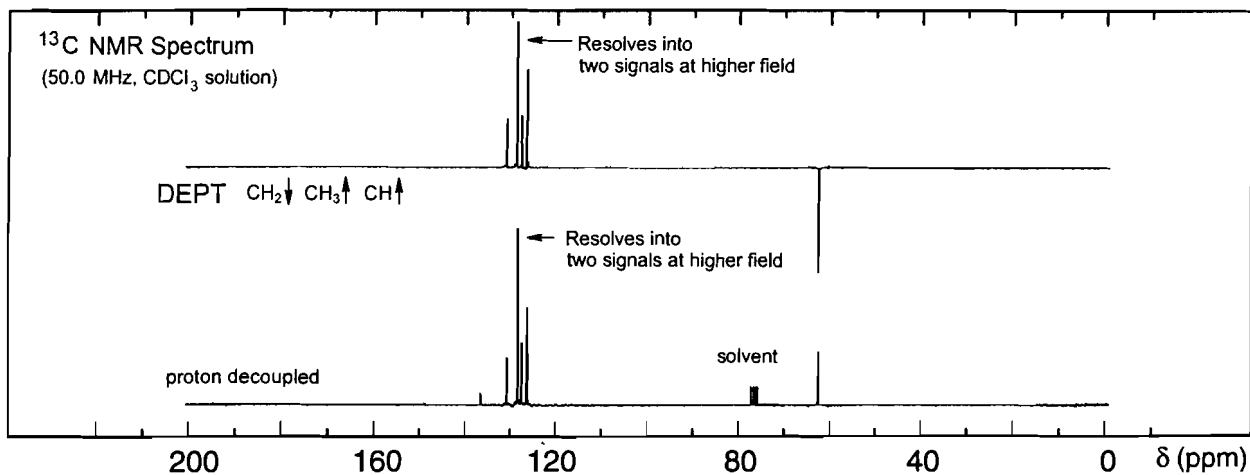
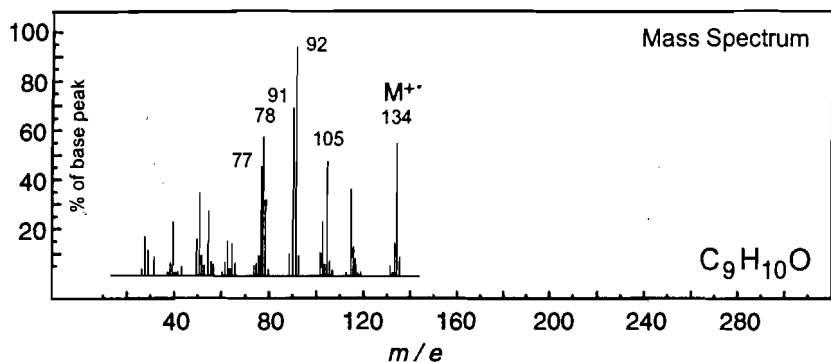
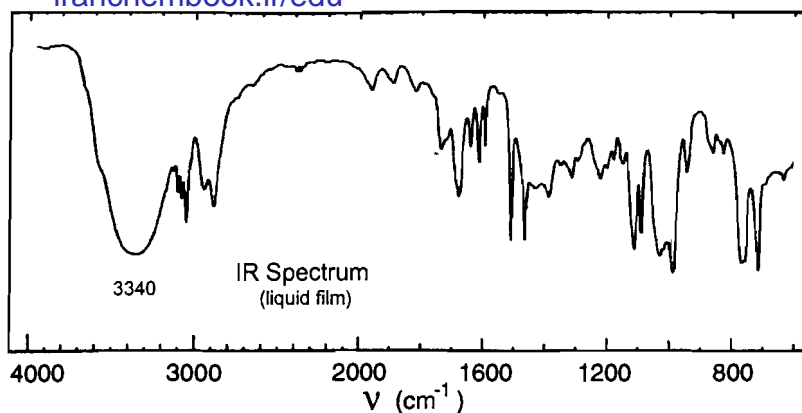



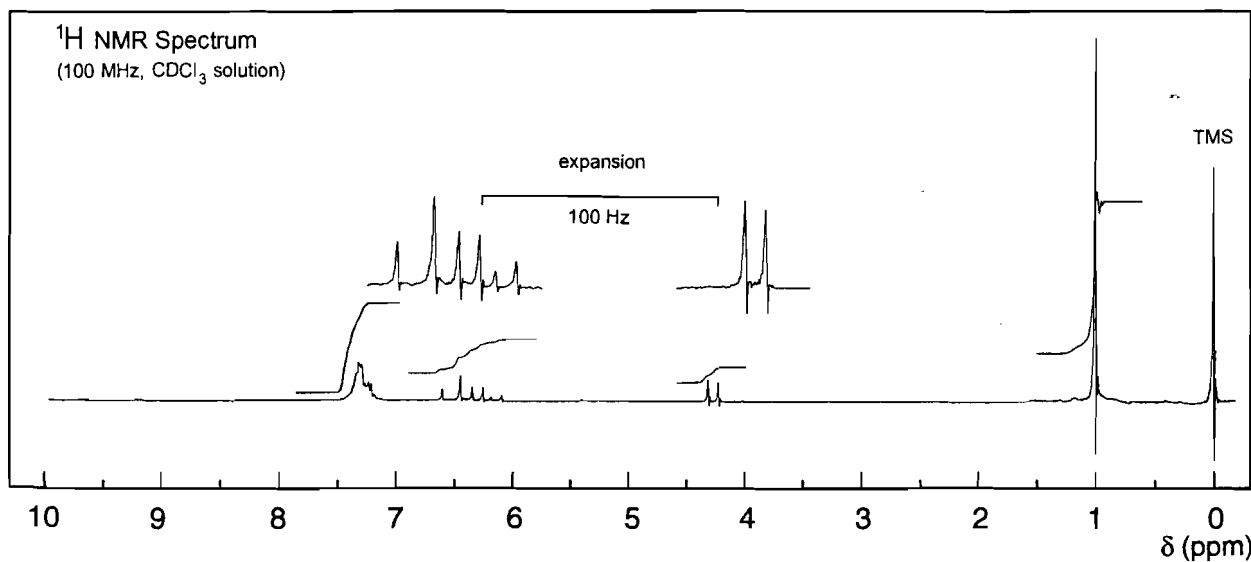
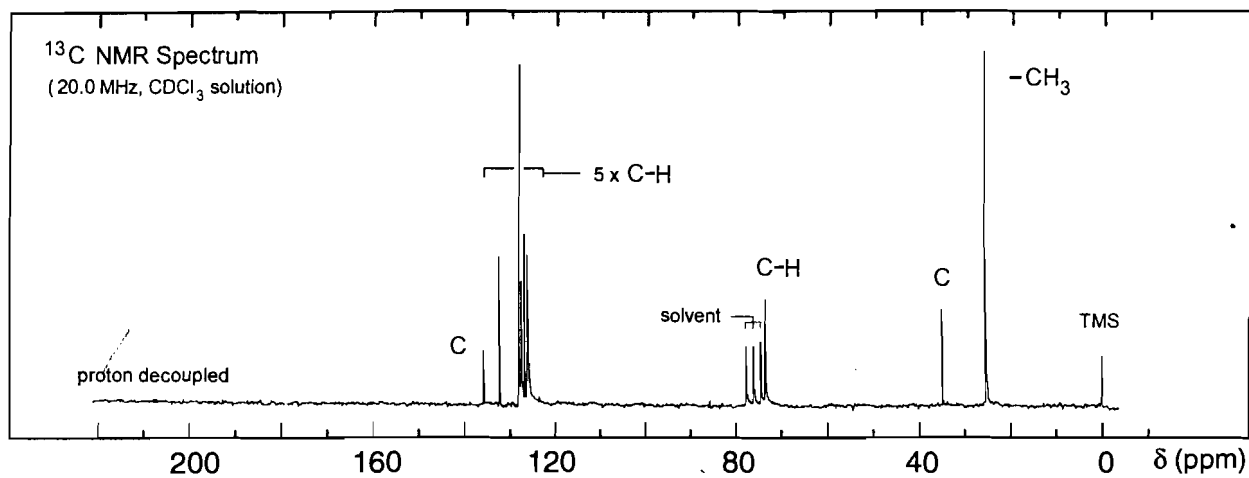
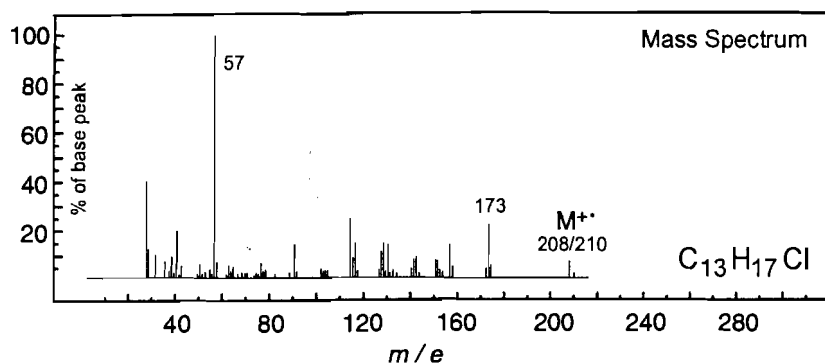
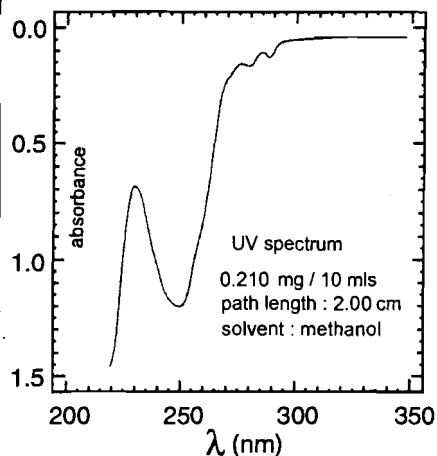
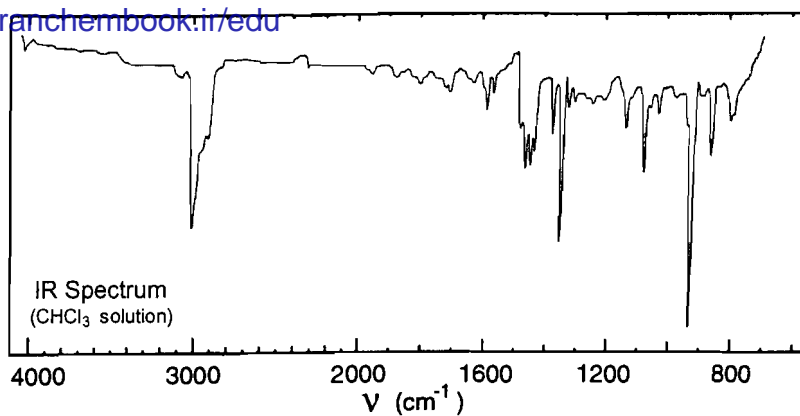

## Problem 208

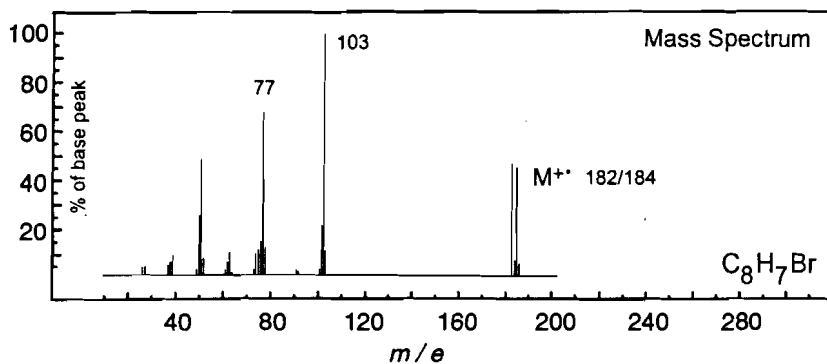
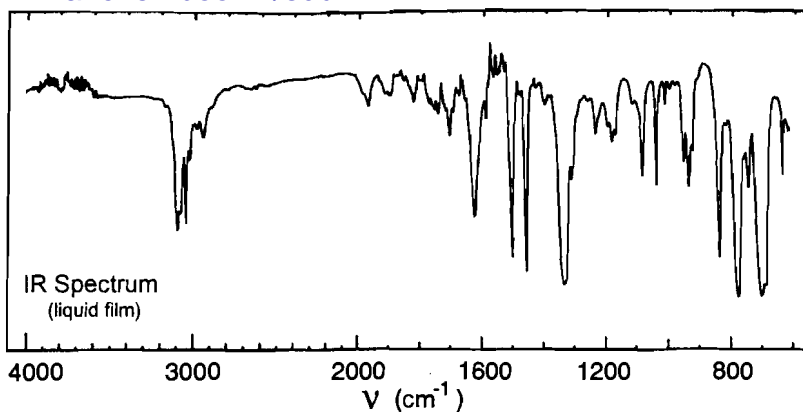

UV Spectrum

$$\lambda_{\max} \approx 250 \text{ nm } (\log_{10} \epsilon > 4.0)$$

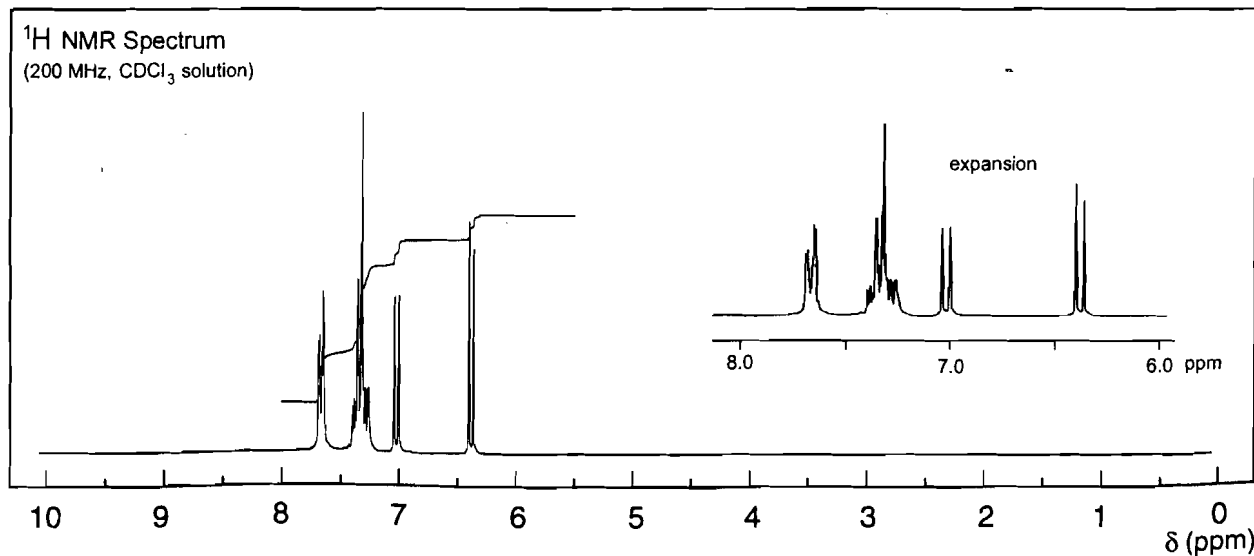
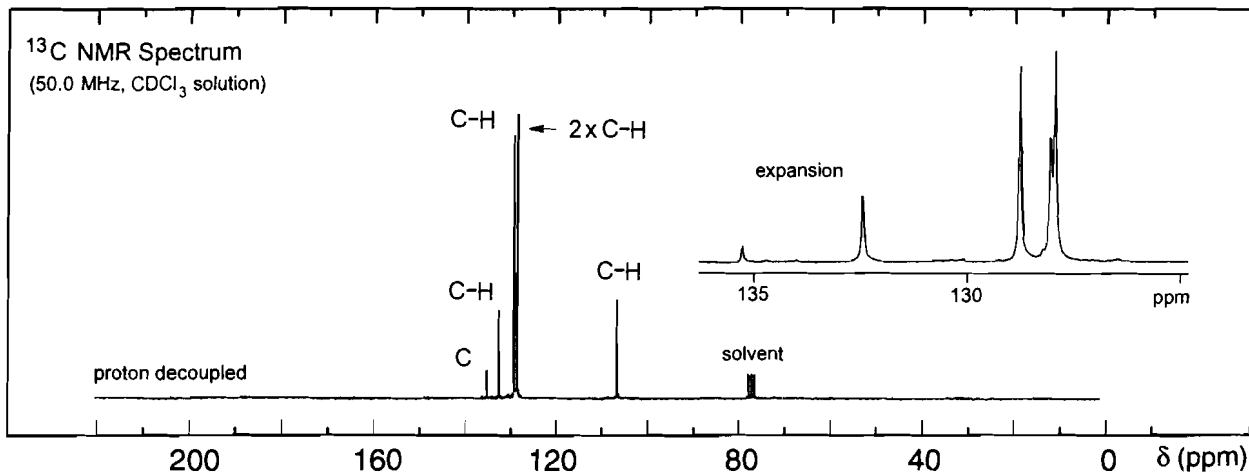

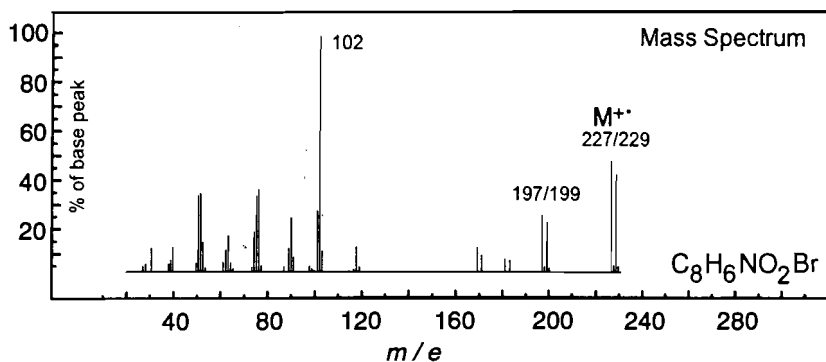
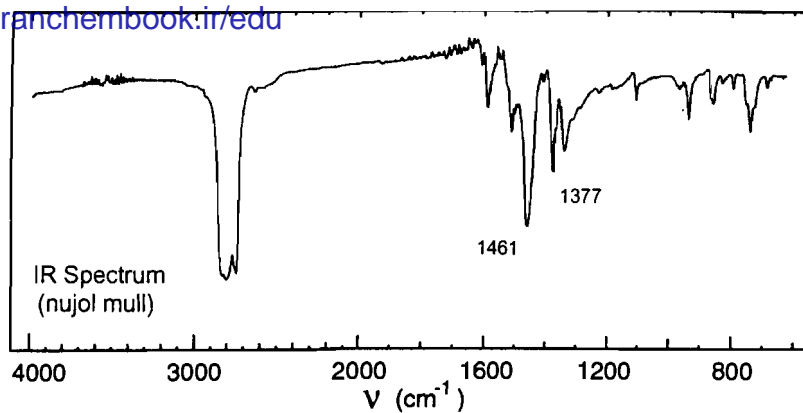

UV Spectrum

$$\lambda_{\text{max}} \approx 250 \text{ nm} \quad (\log_{10} \epsilon > 4.0)$$

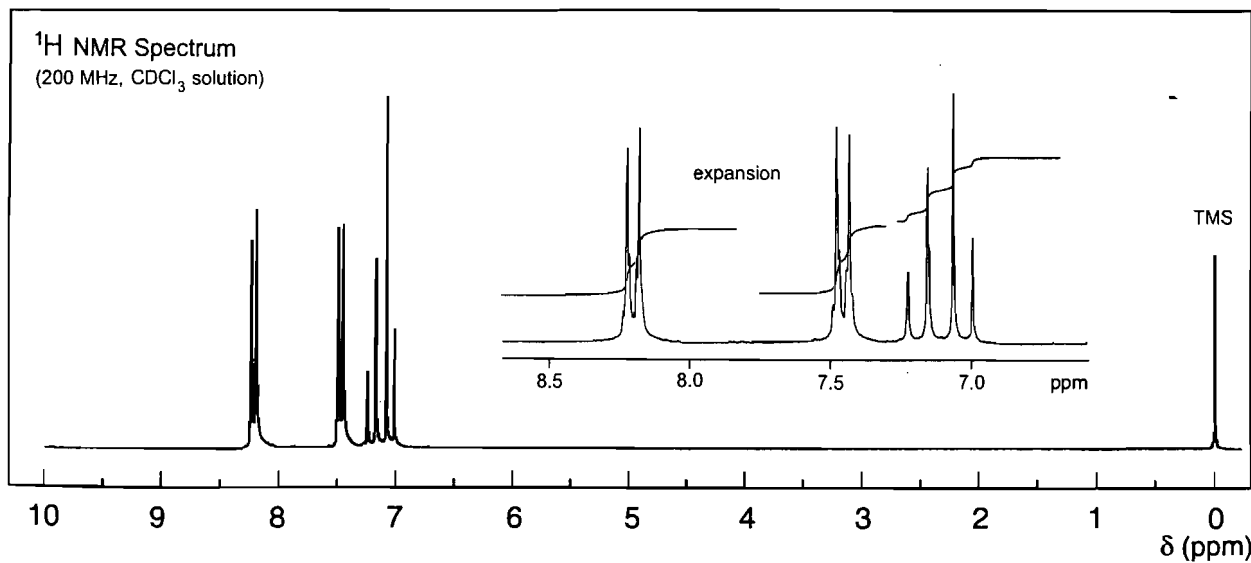
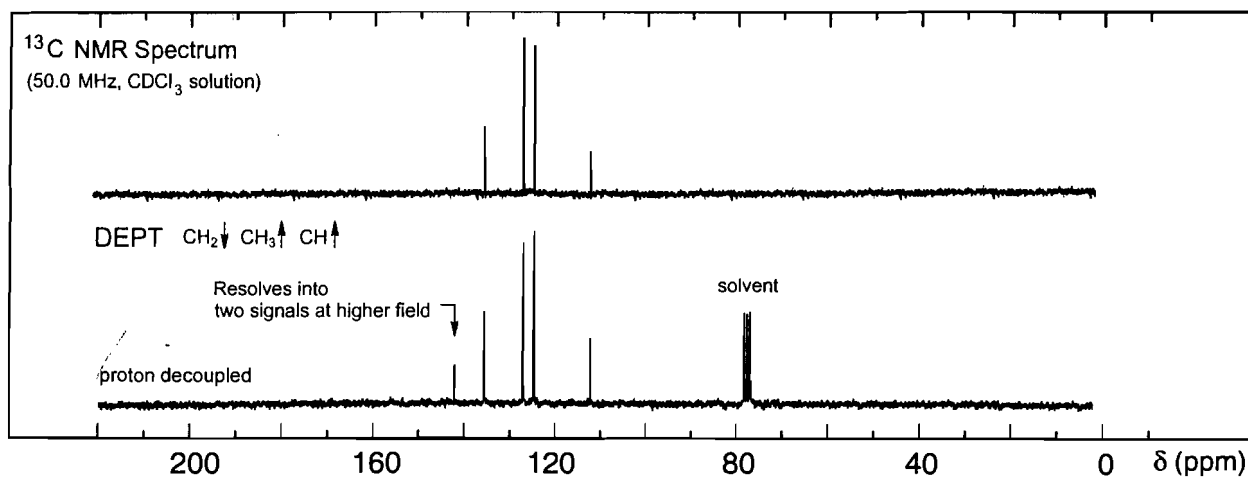

## Problem 210

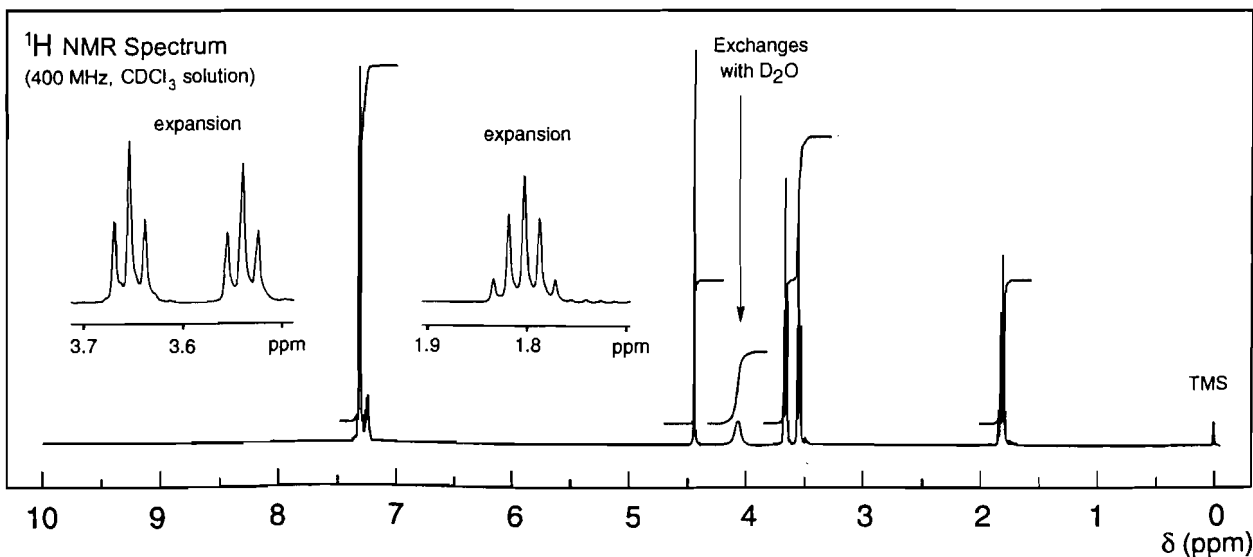
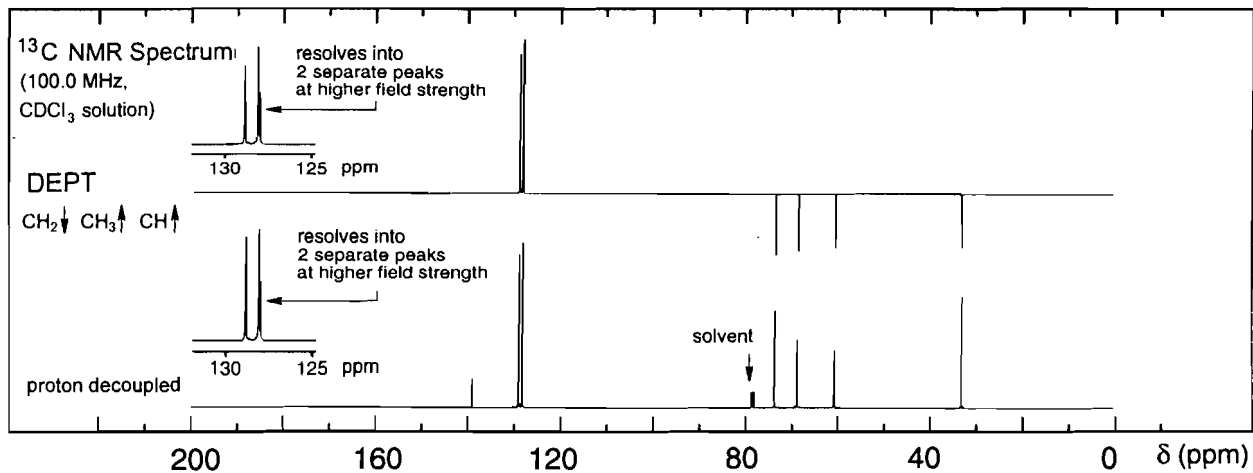
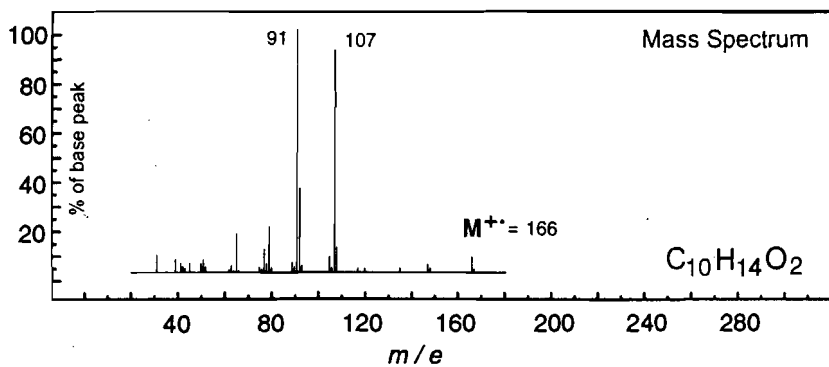
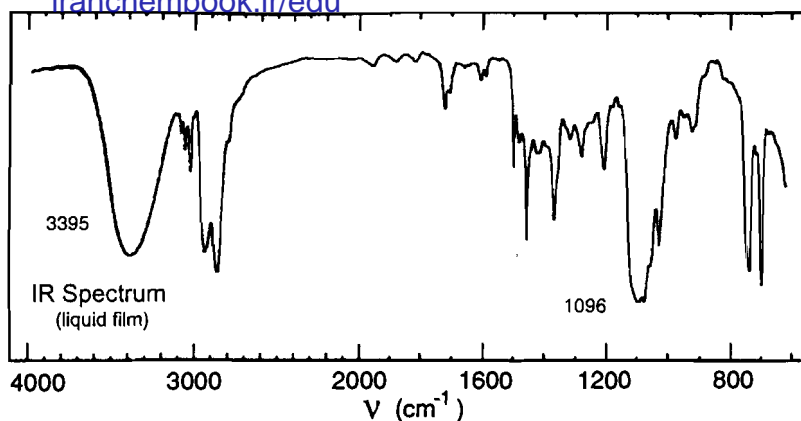

## Problem 211

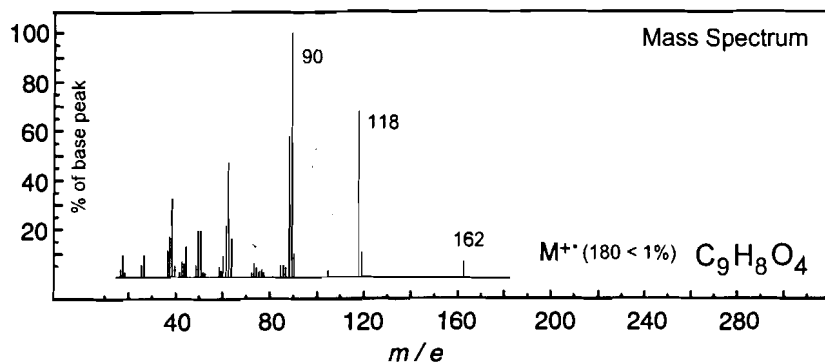
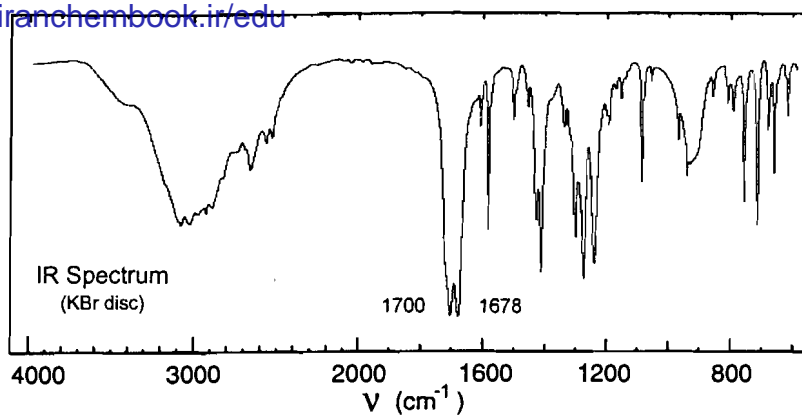

UV Spectrum

 $\lambda_{\text{max}}$  276 nm ( $\log_{10} \epsilon$  3.1) $\lambda_{\text{max}}$  228 nm ( $\log_{10} \epsilon$  3.9)

solvent : methanol

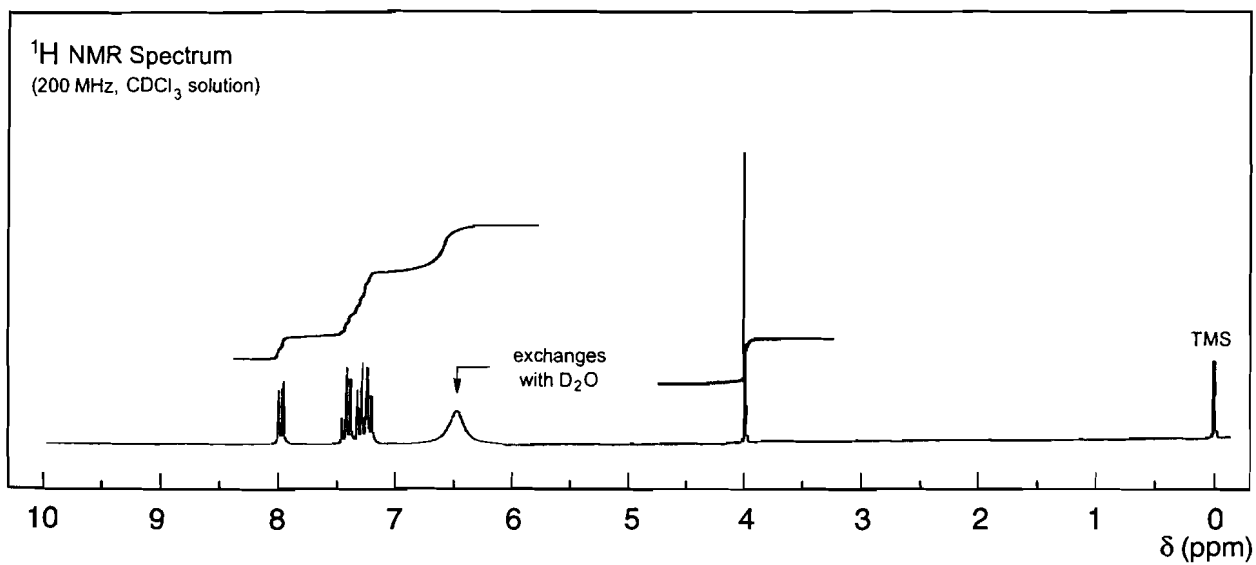
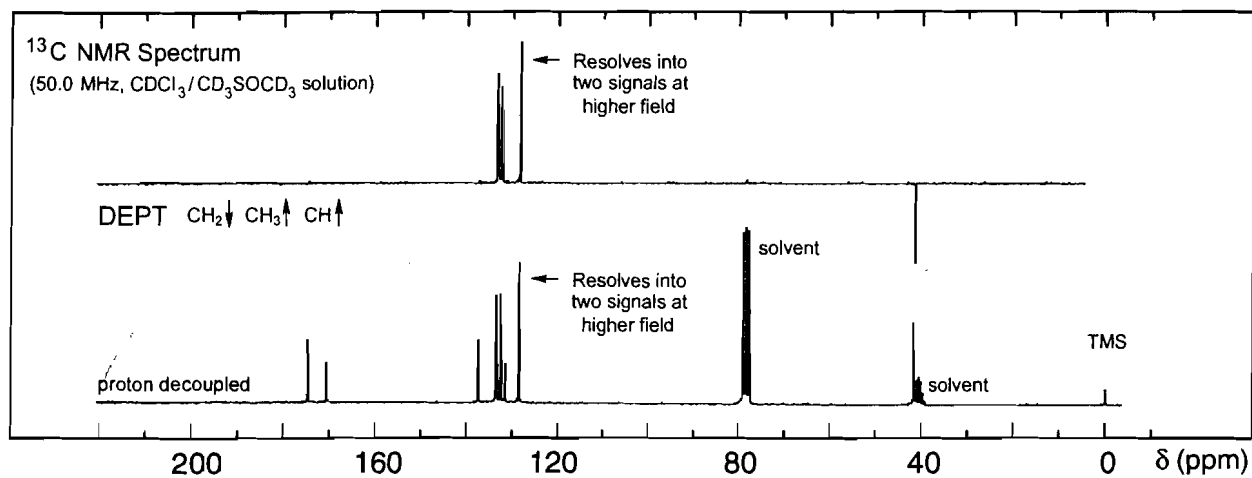

## Problem 212

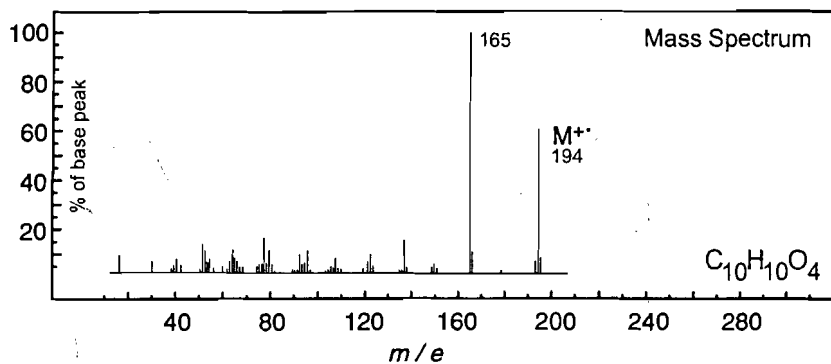
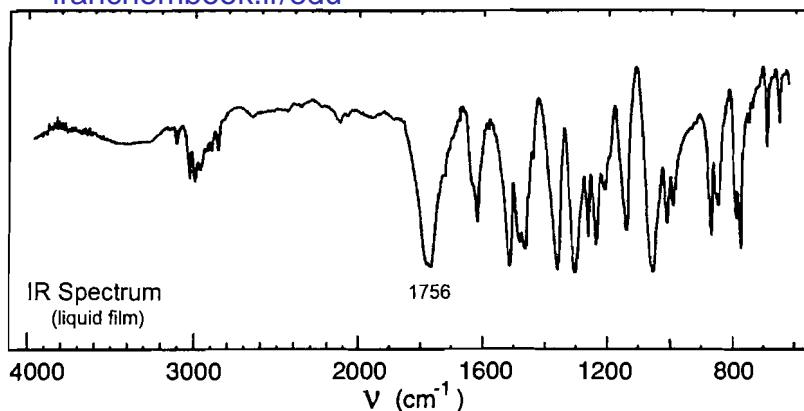

UV Spectrum

 $\lambda_{\max}$  232 nm ( $\log_{10} \epsilon$  3.8) $\lambda_{\max}$  300 nm ( $\log_{10} \epsilon$  3.6)

solvent : methanol

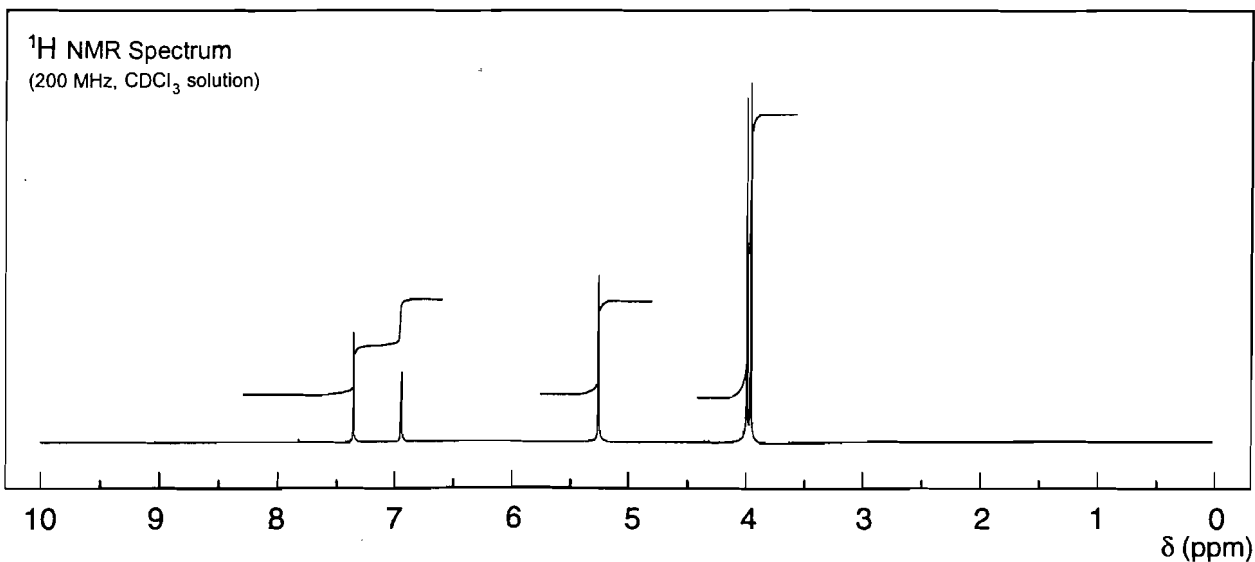
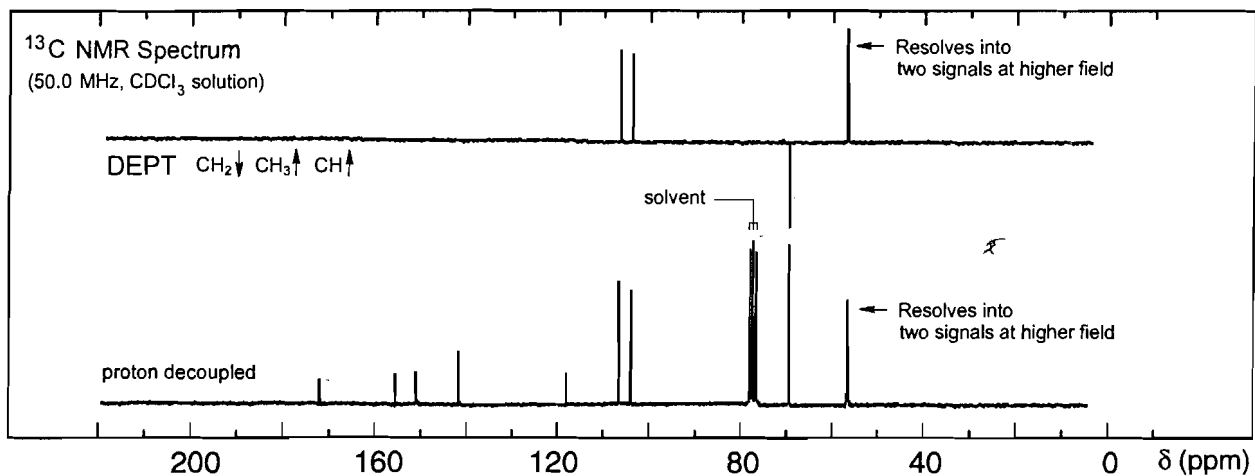

## Problem 213

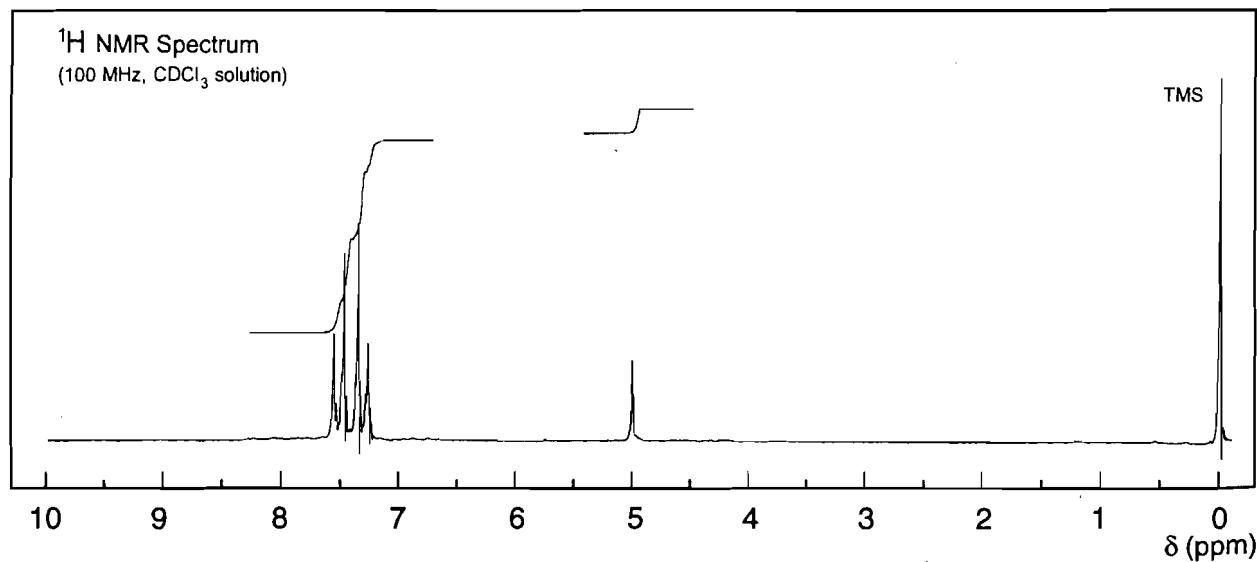
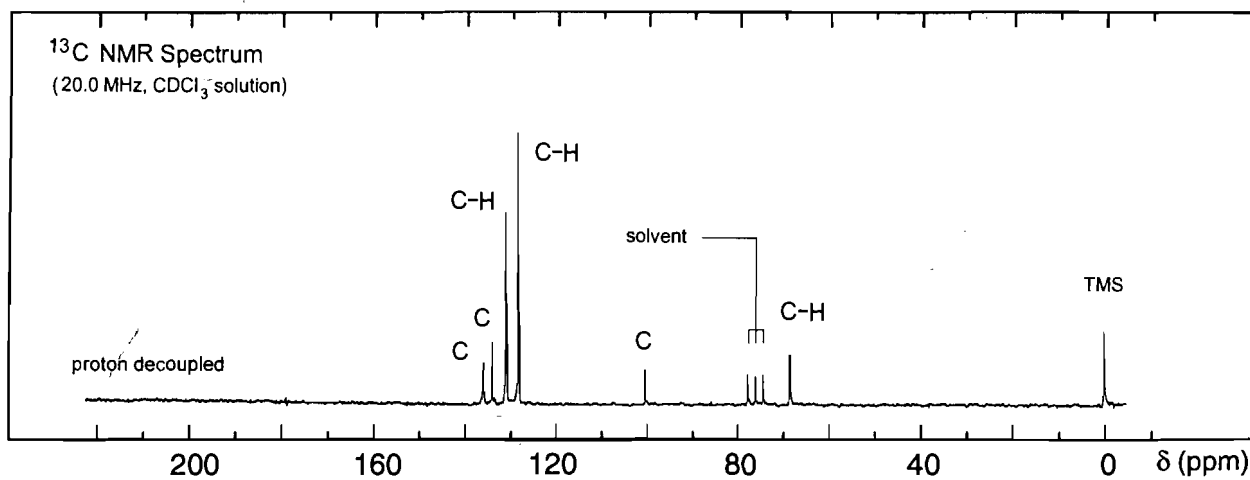
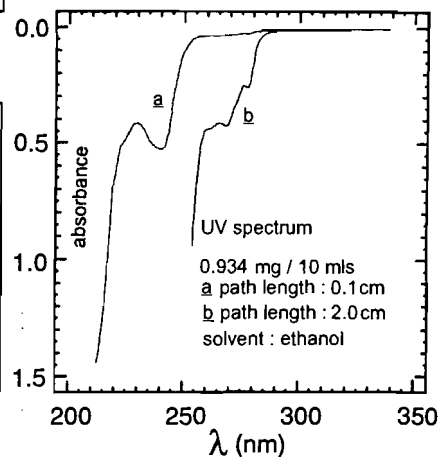
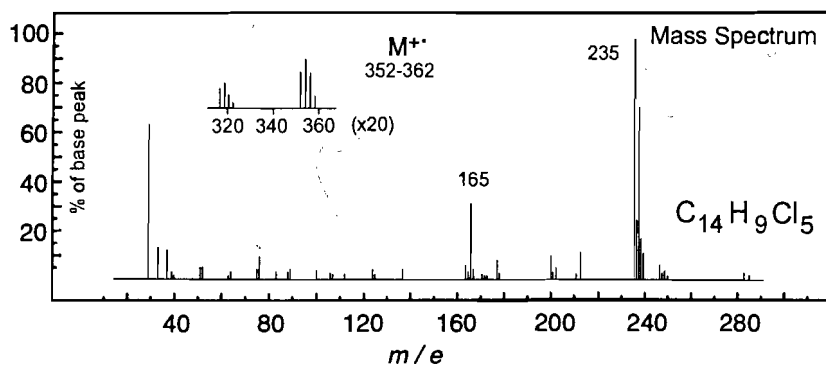
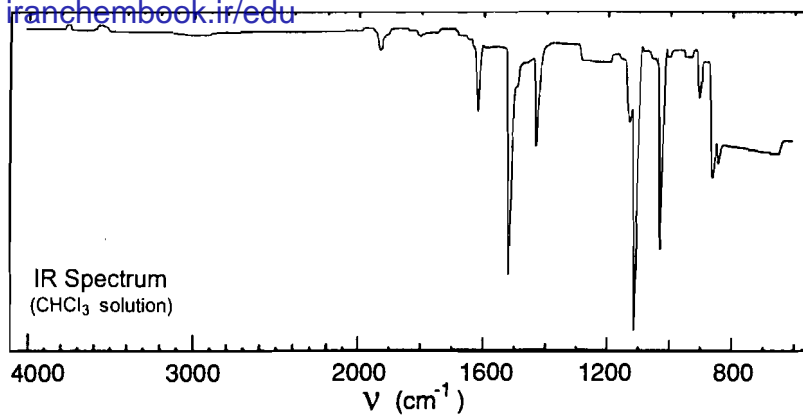

## Problem 214

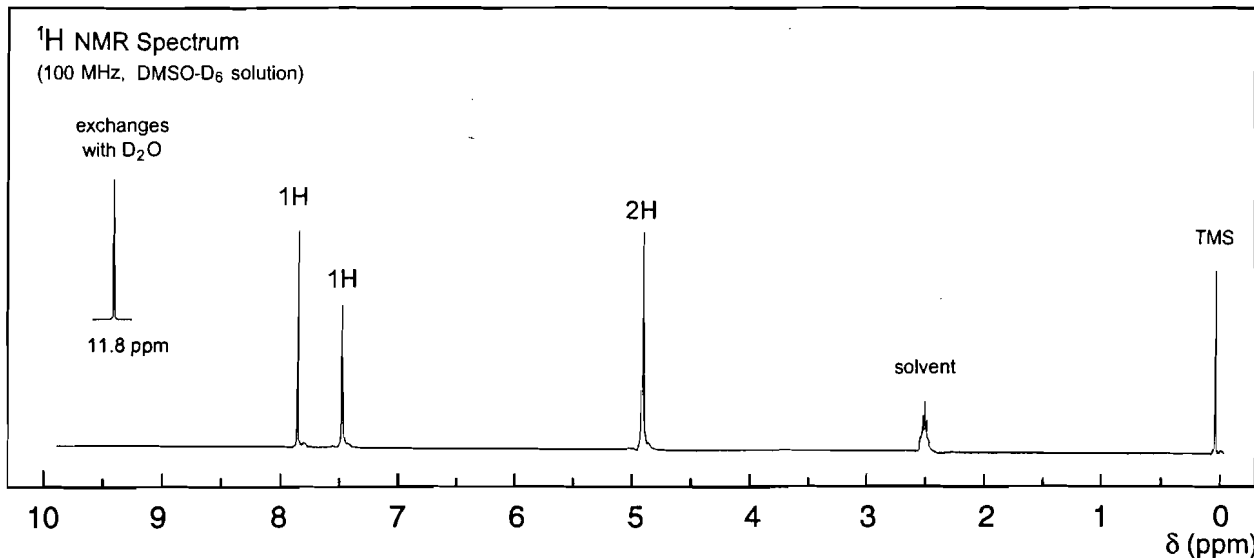
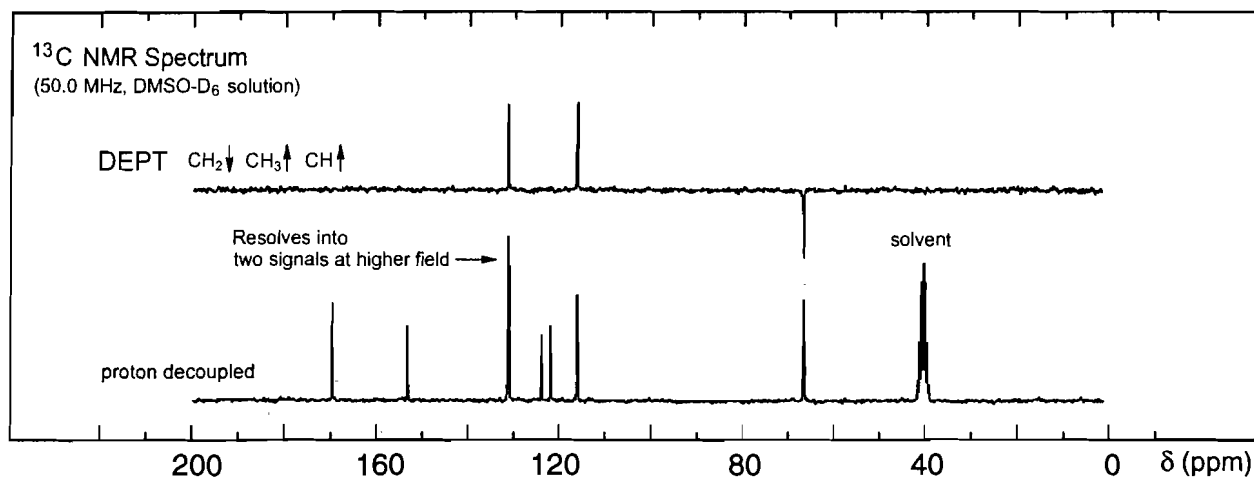
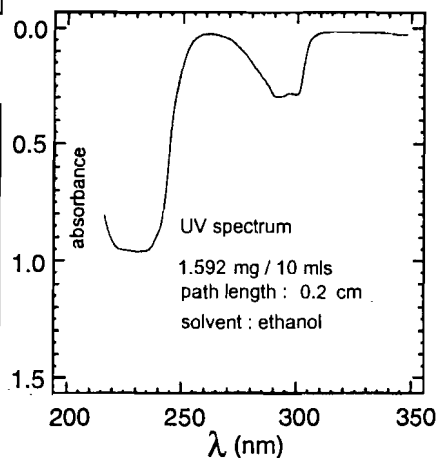
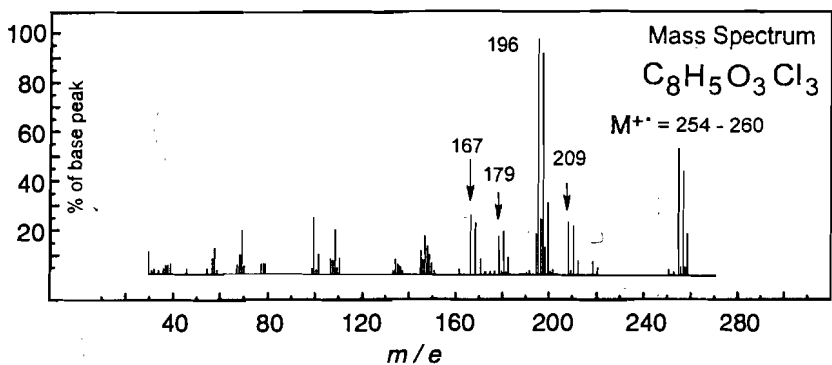
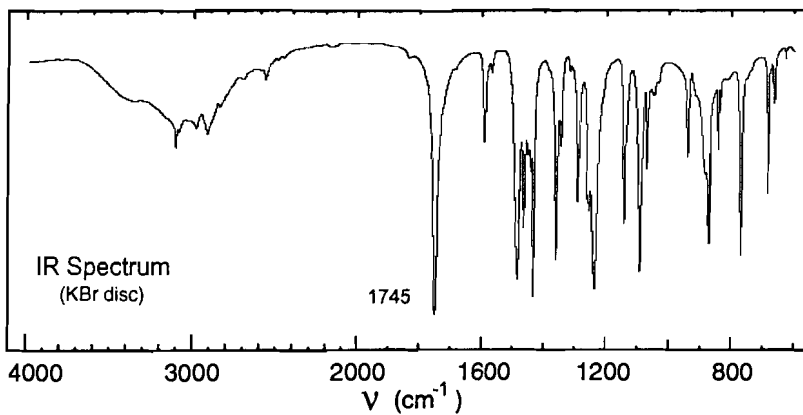



## Problem 215

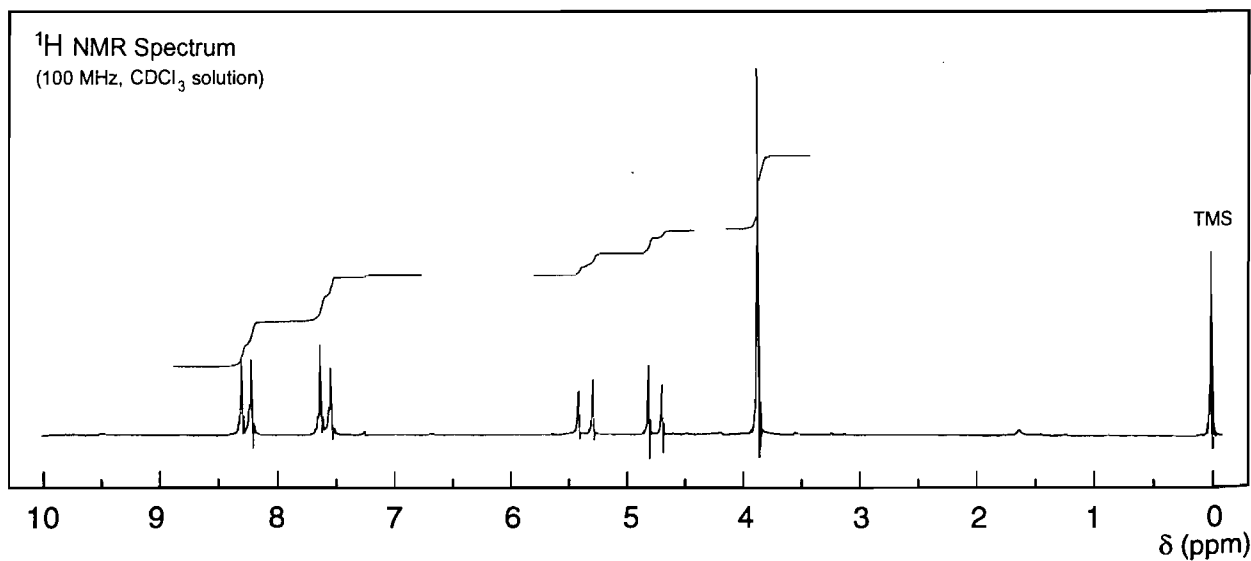
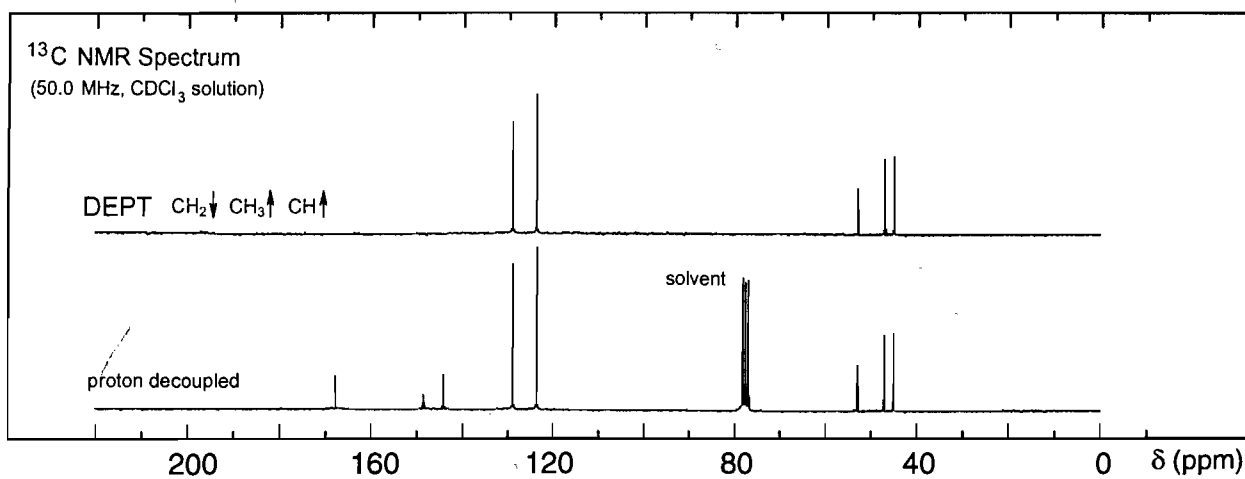
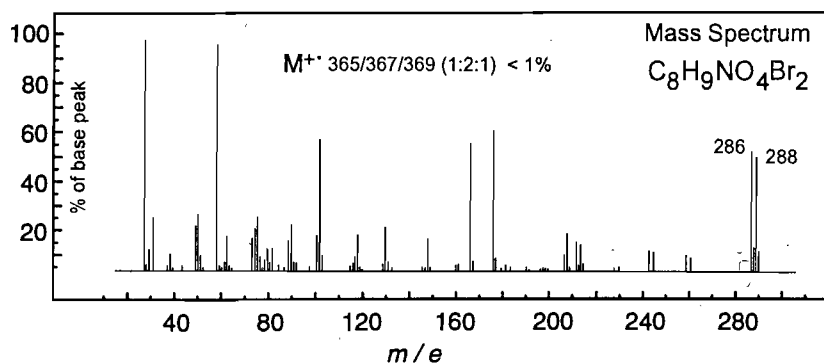
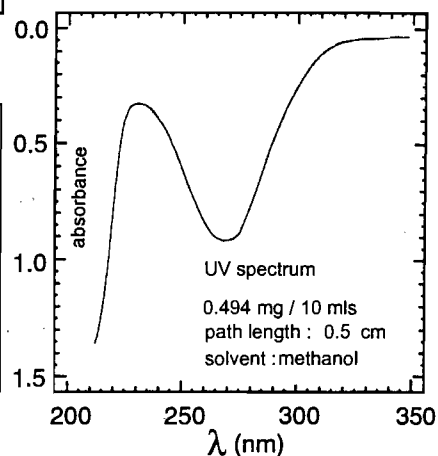
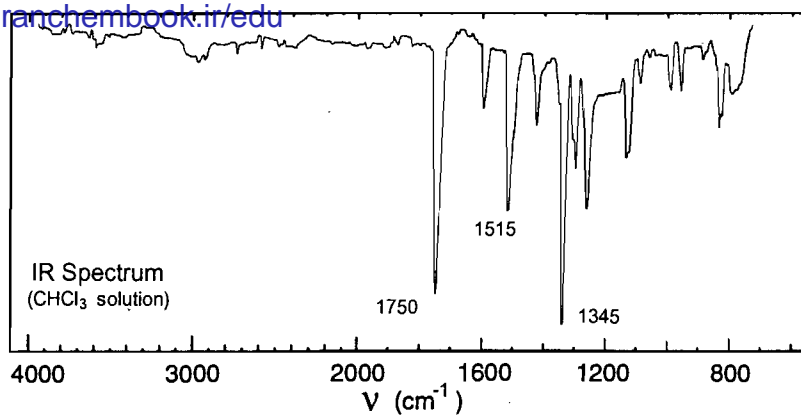

## Problem 216

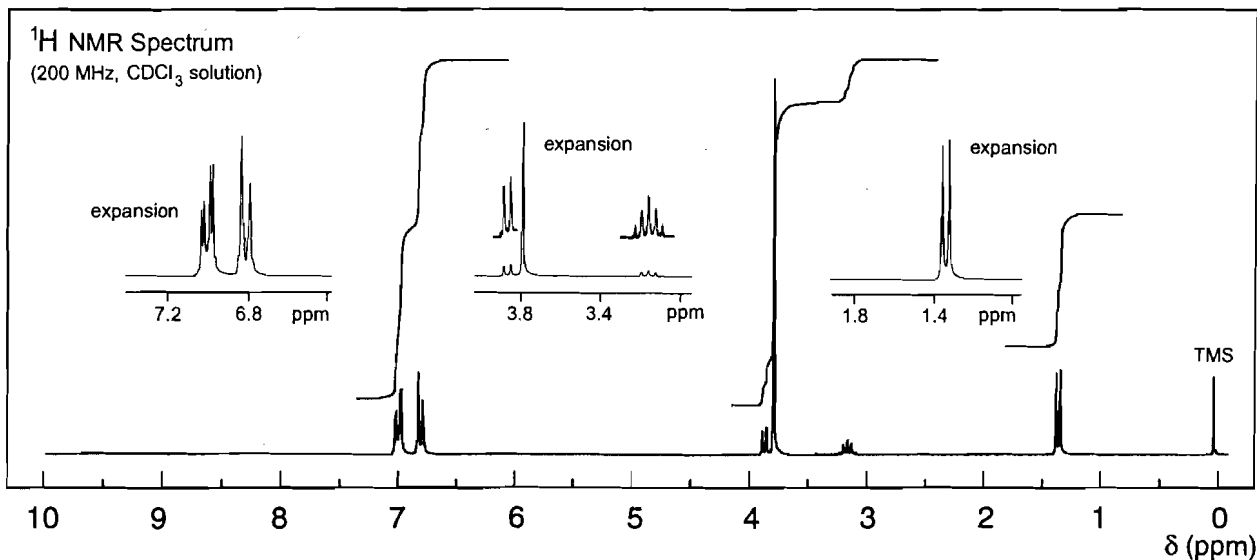
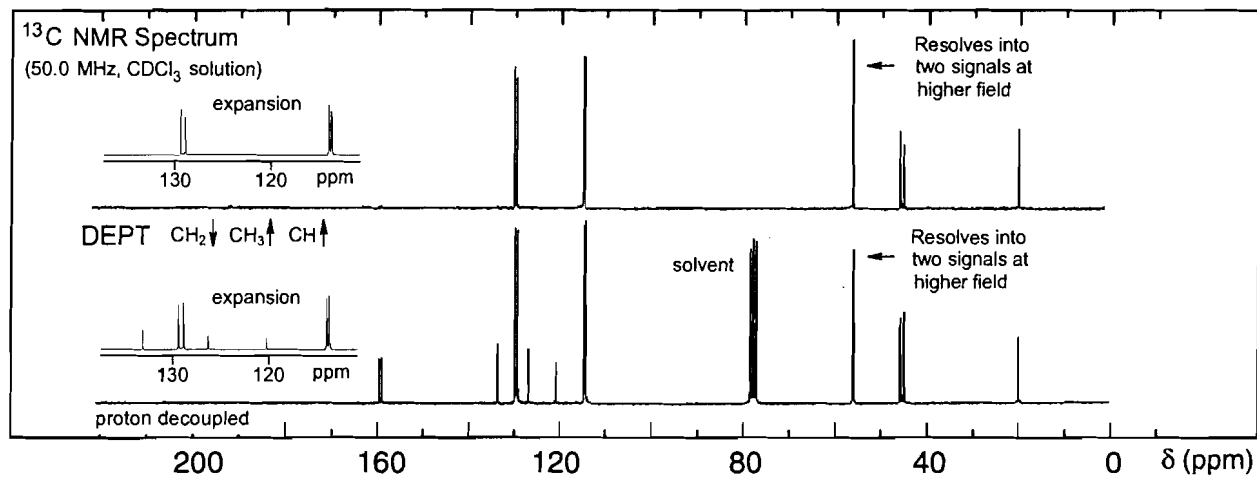
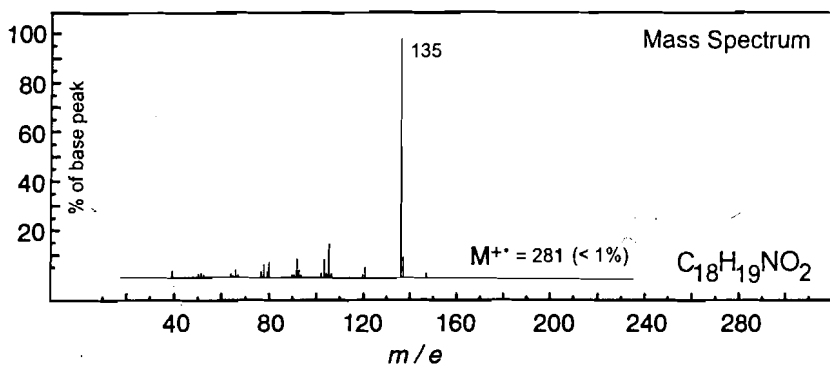
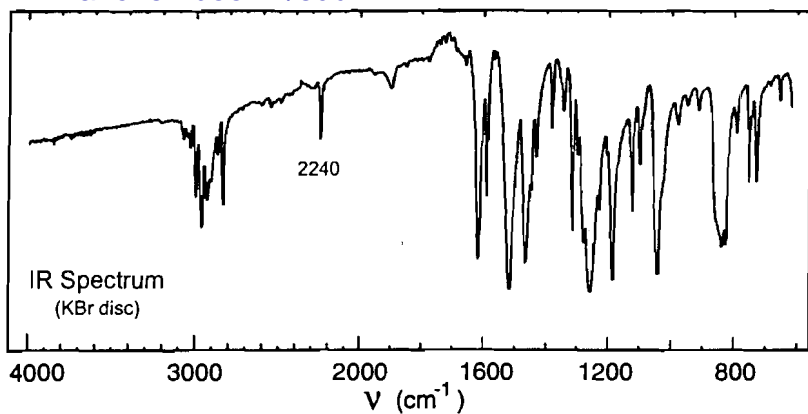

## Problem 217

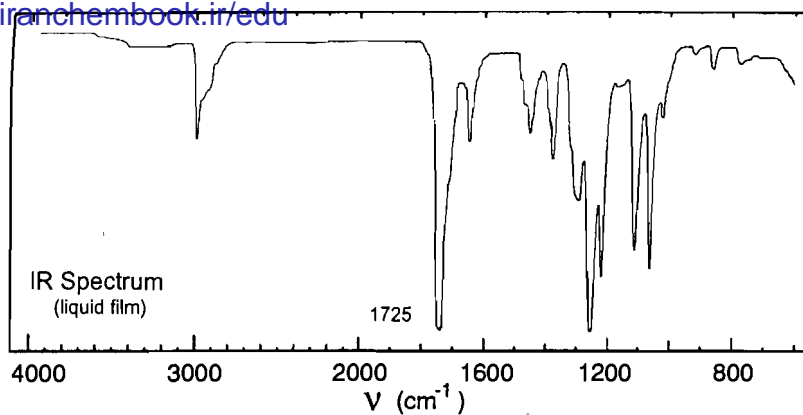

Note: ozonolysis of this compound affords acetone

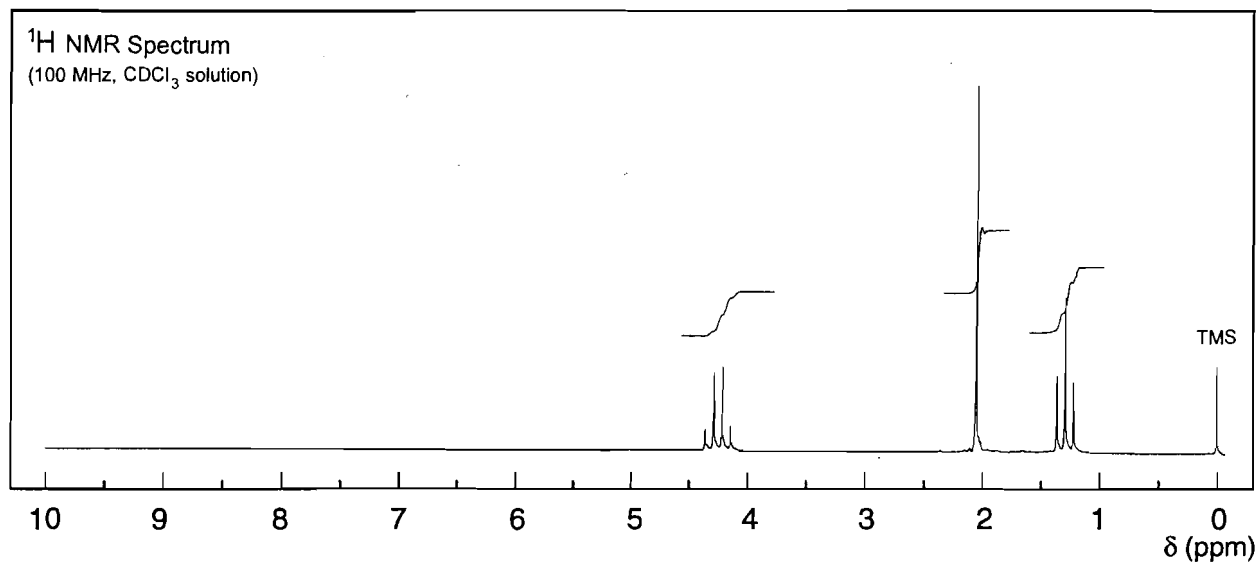
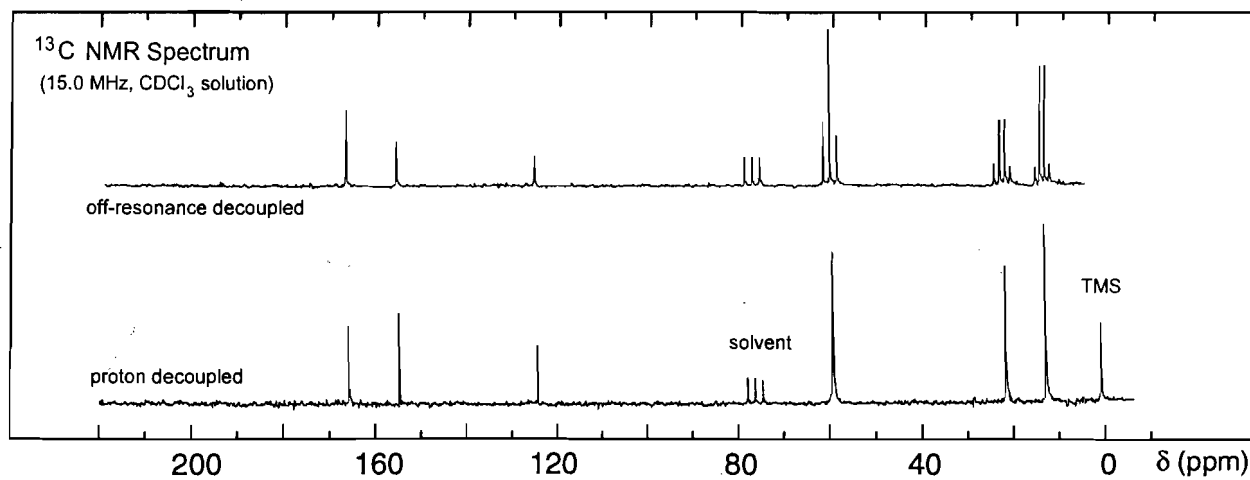
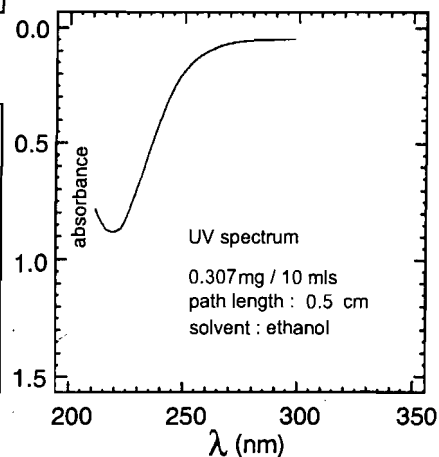
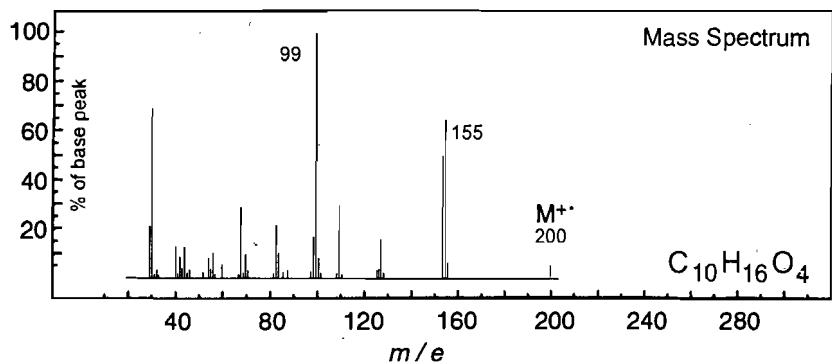

## Problem 218

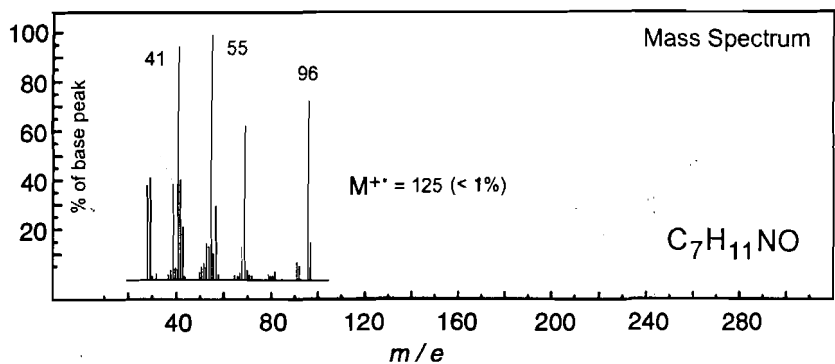
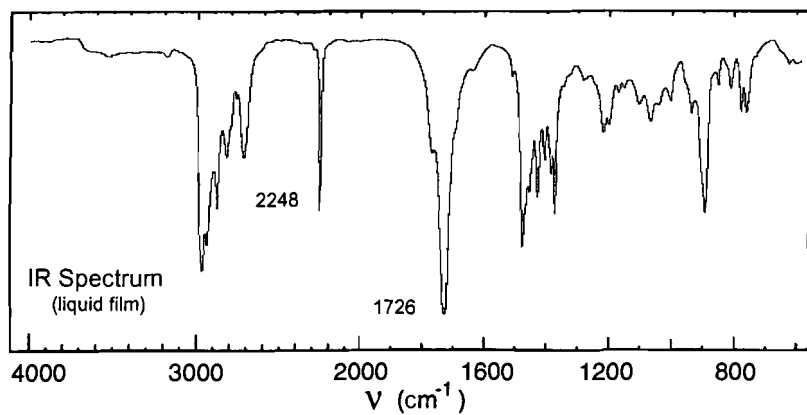

No significant UV  
absorption above 220 nm

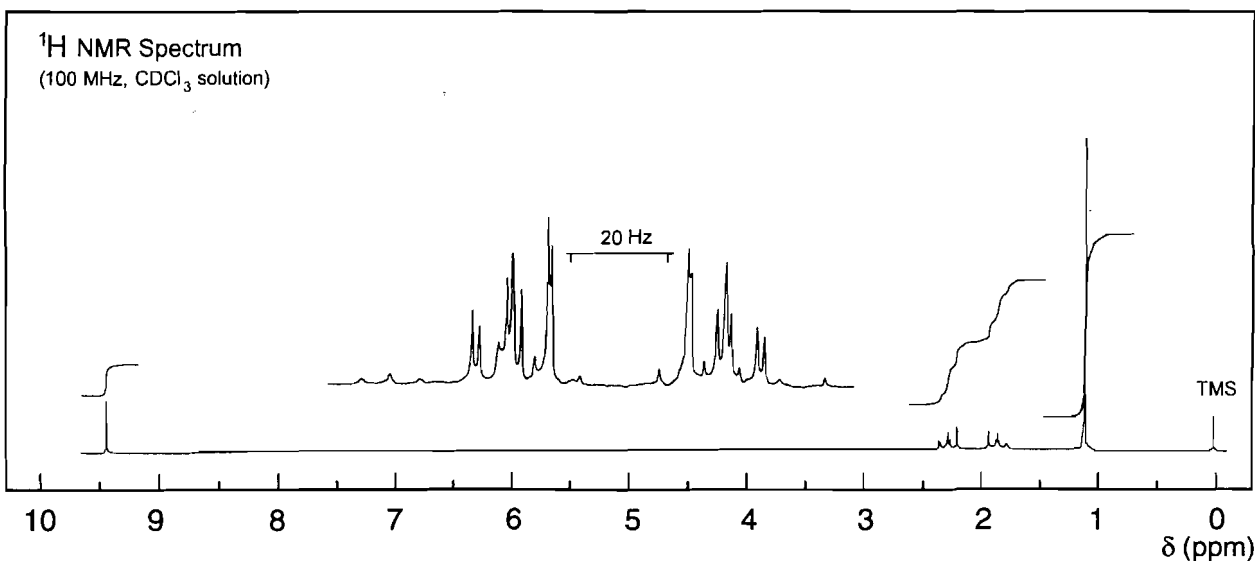
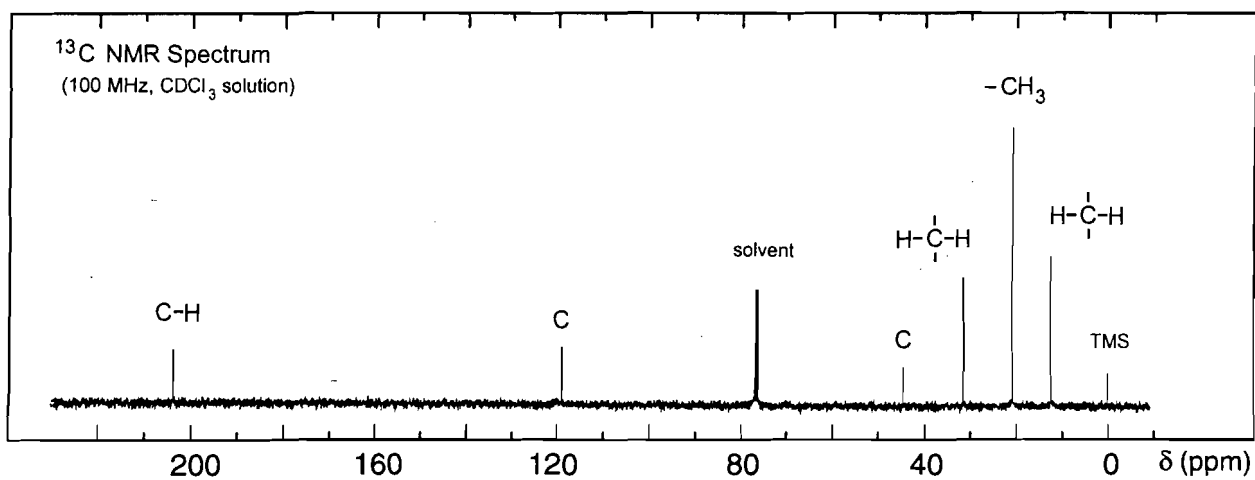

## Problem 219

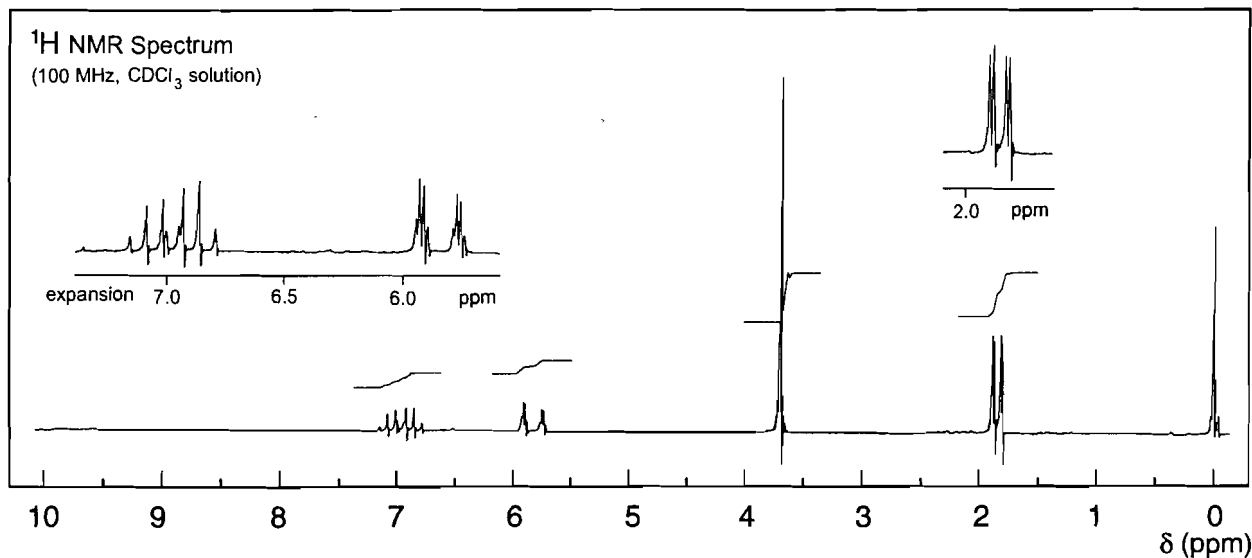
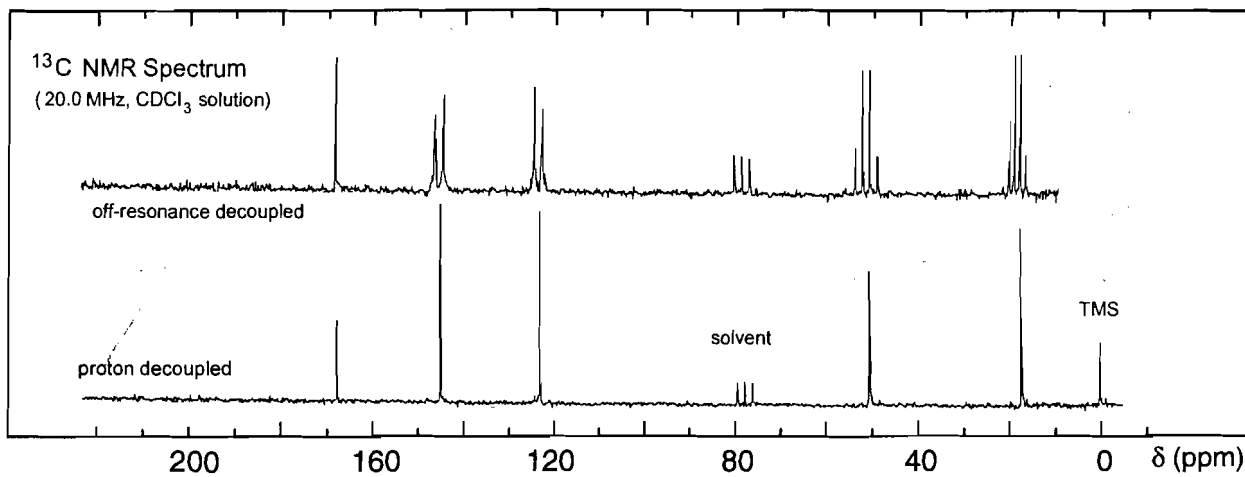
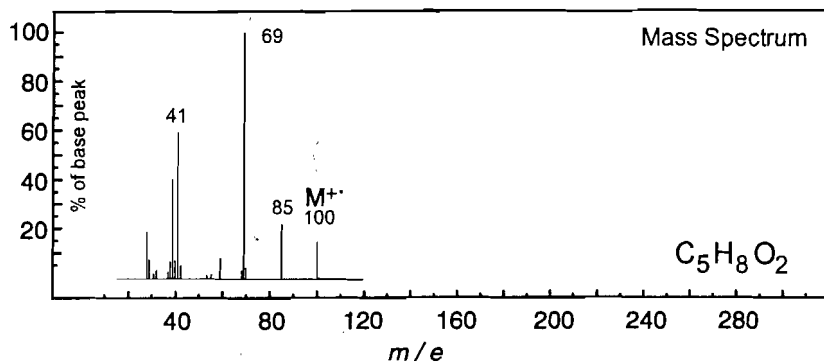
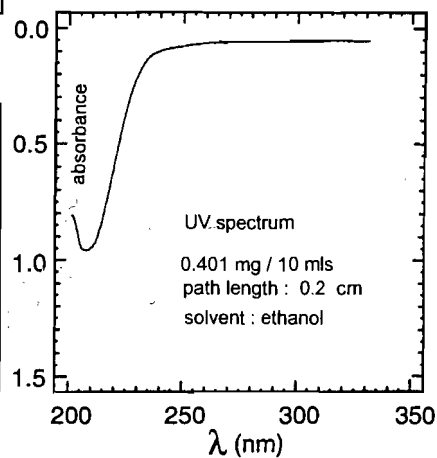
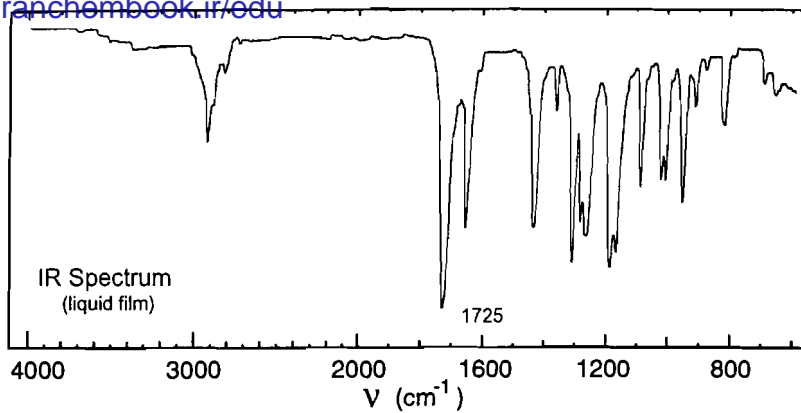

## Problem 220

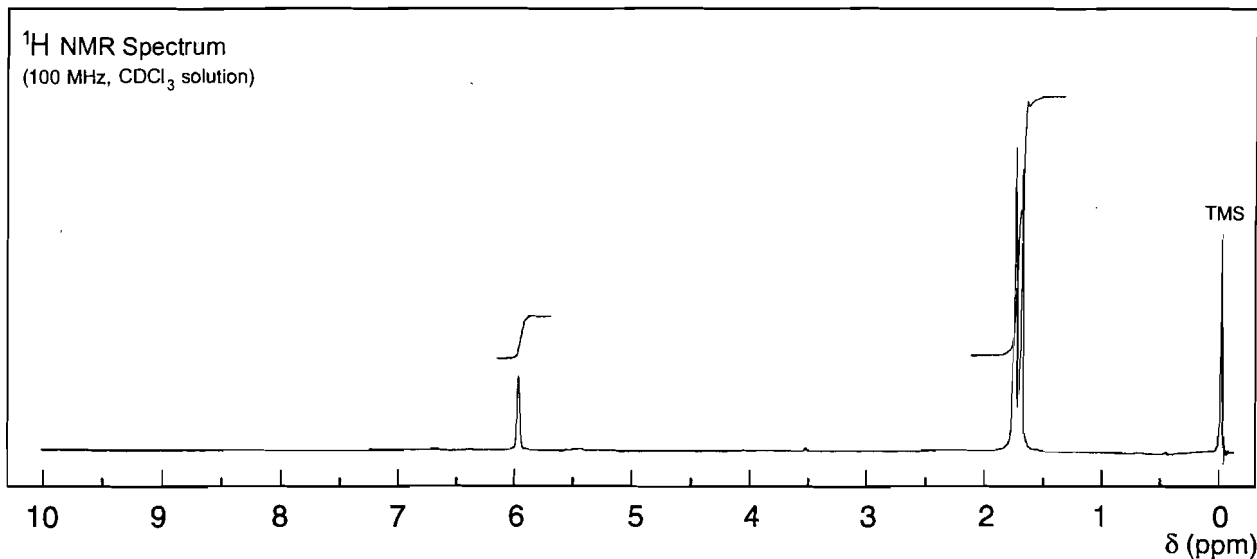
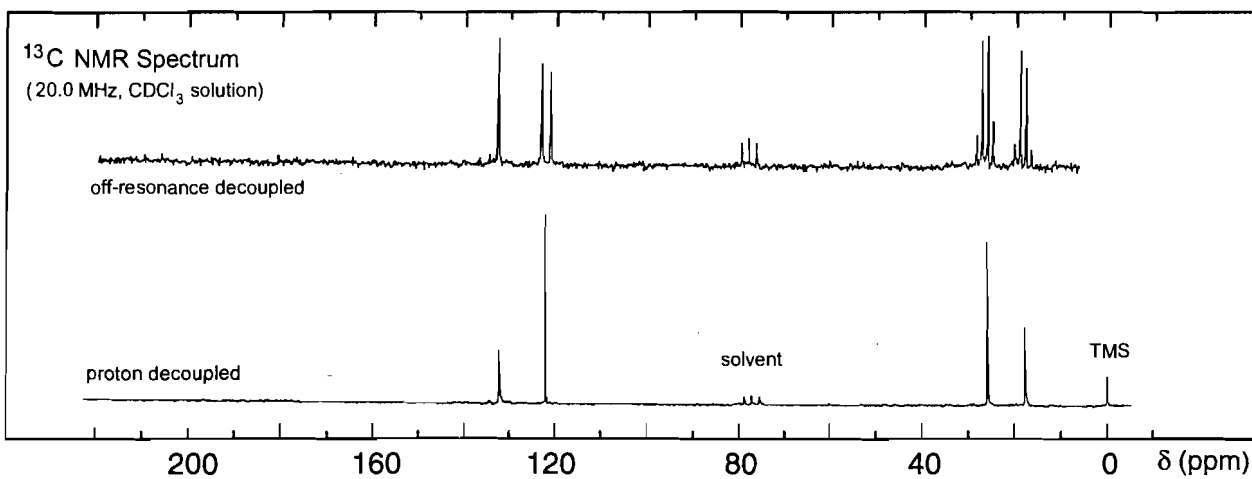
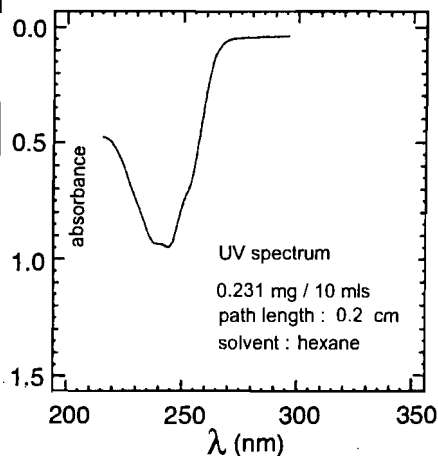
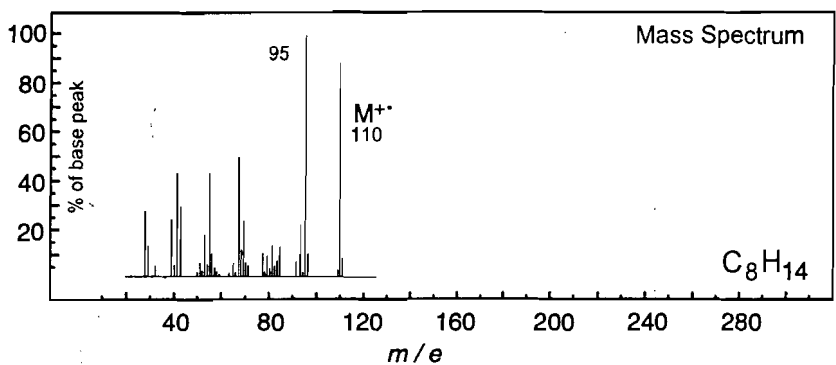
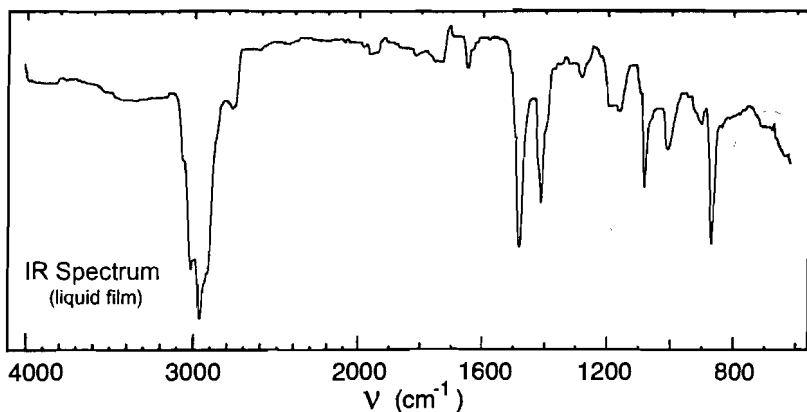

## Problem 221

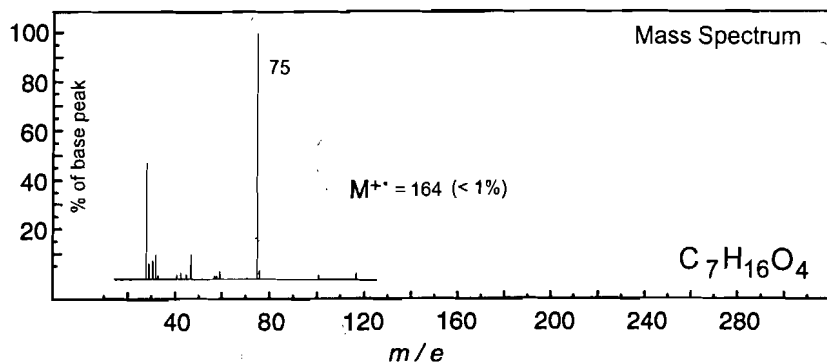
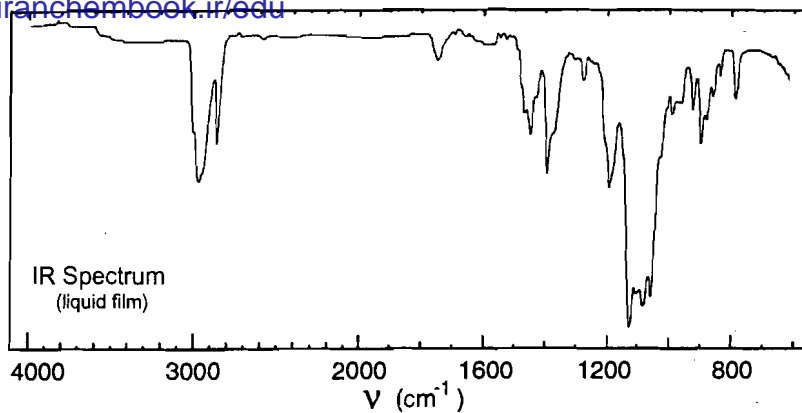

No significant UV  
absorption above 220 nm

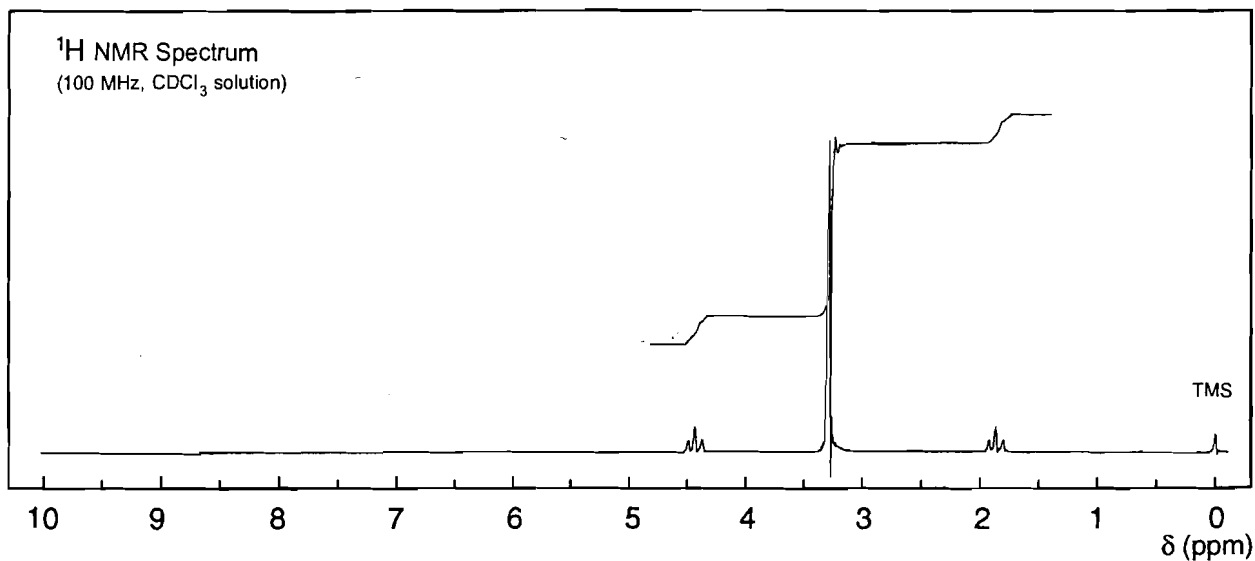
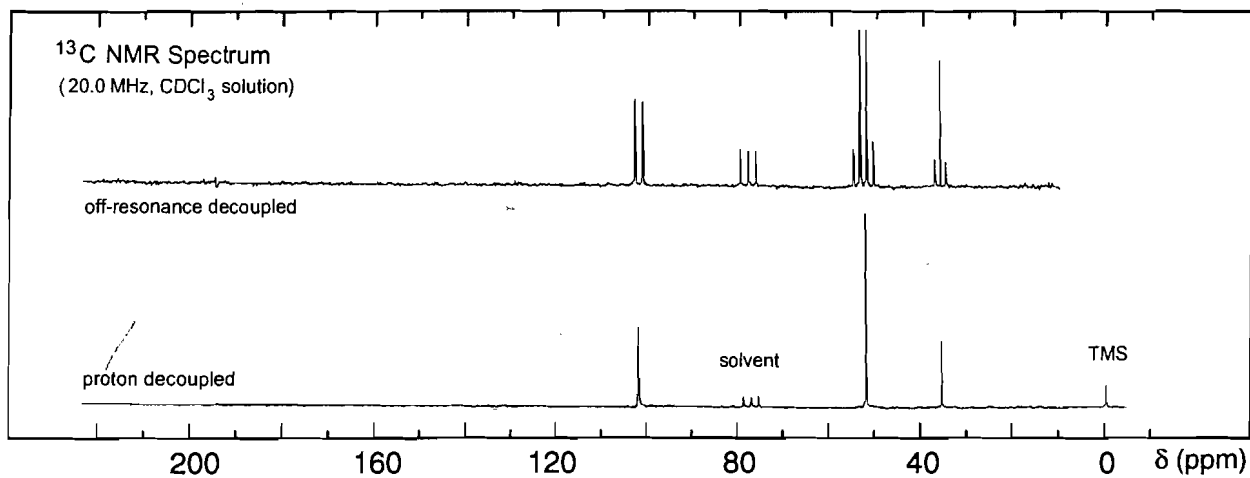

## Problem 222

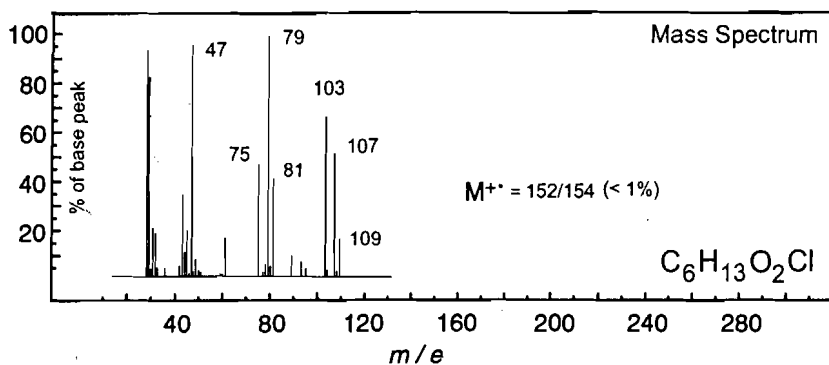
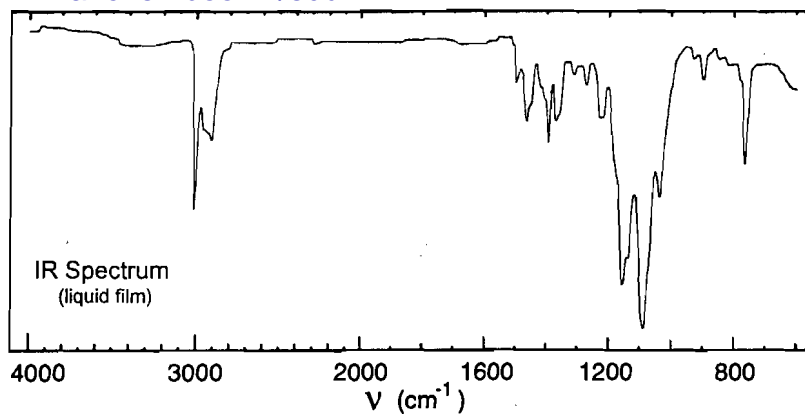

No significant UV  
absorption above 220 nm

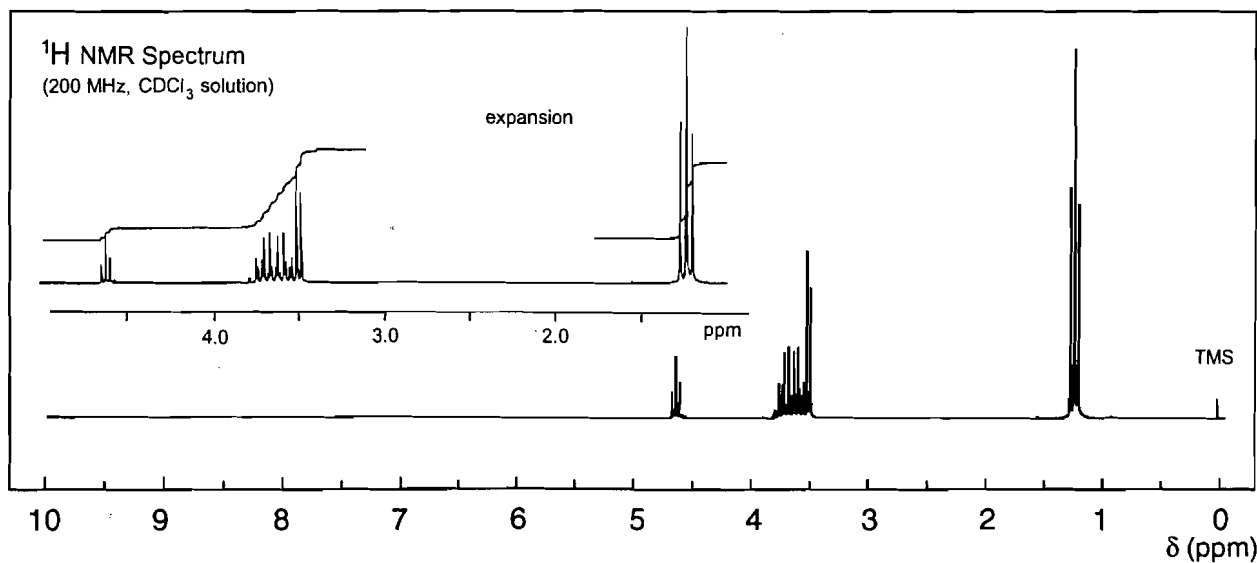
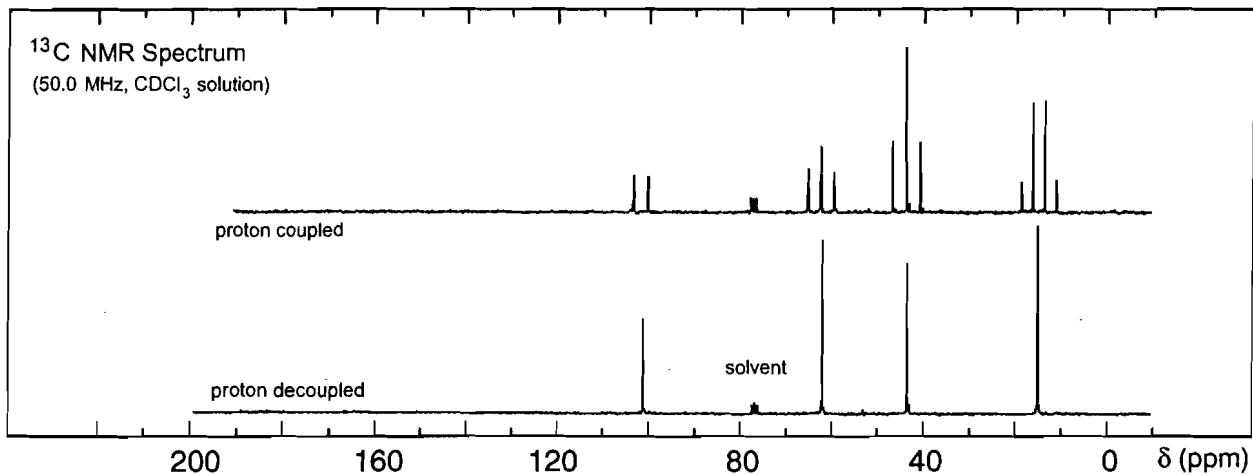



## Problem 223

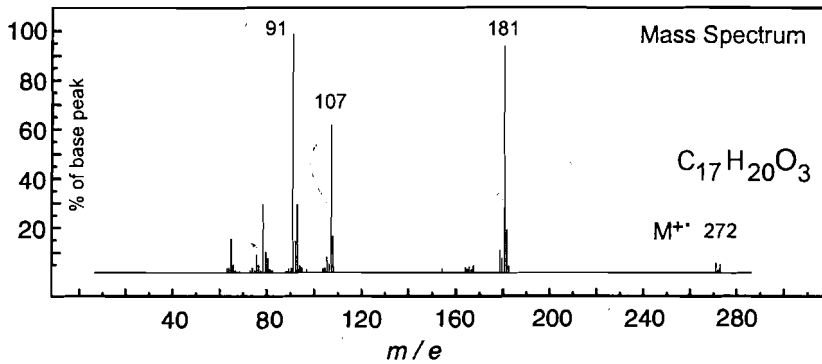
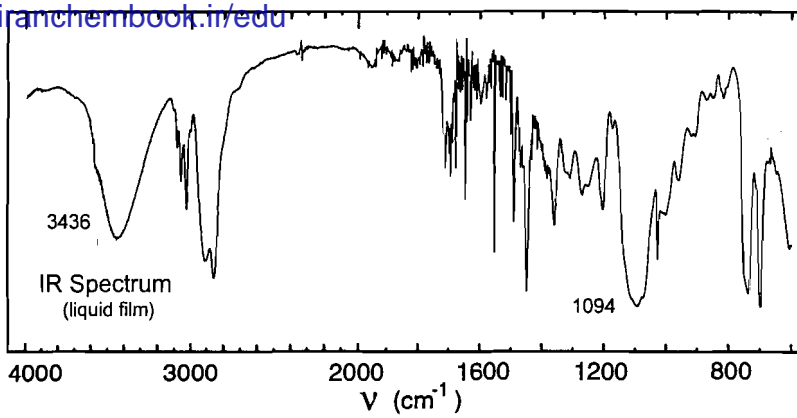

UV Spectrum

 $\log_{10} \epsilon$  between 2 and 3

solvent: methanol

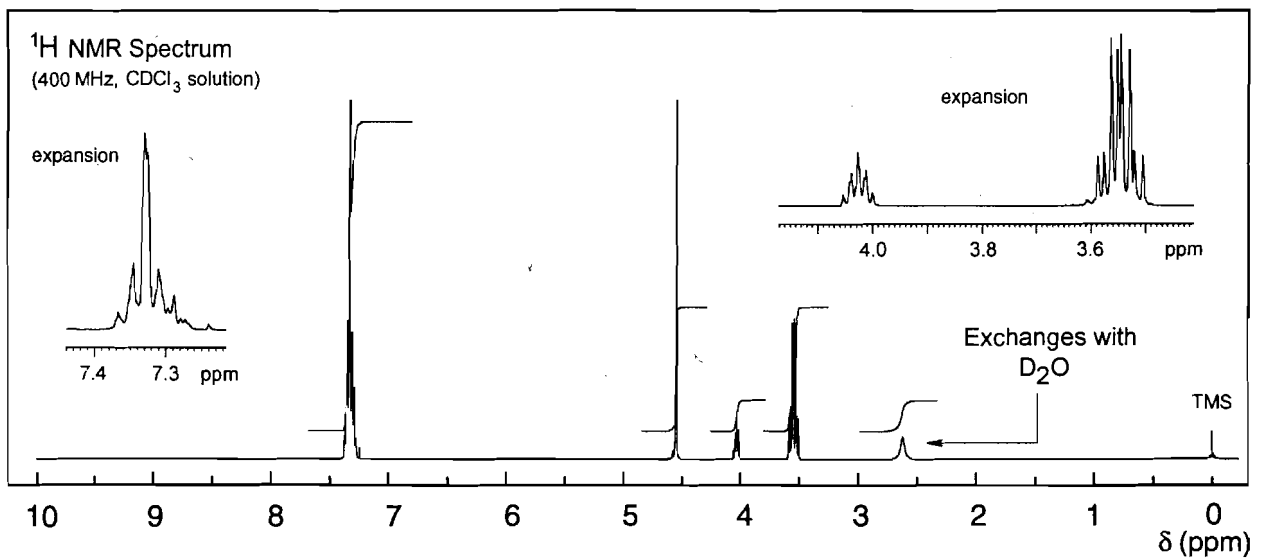
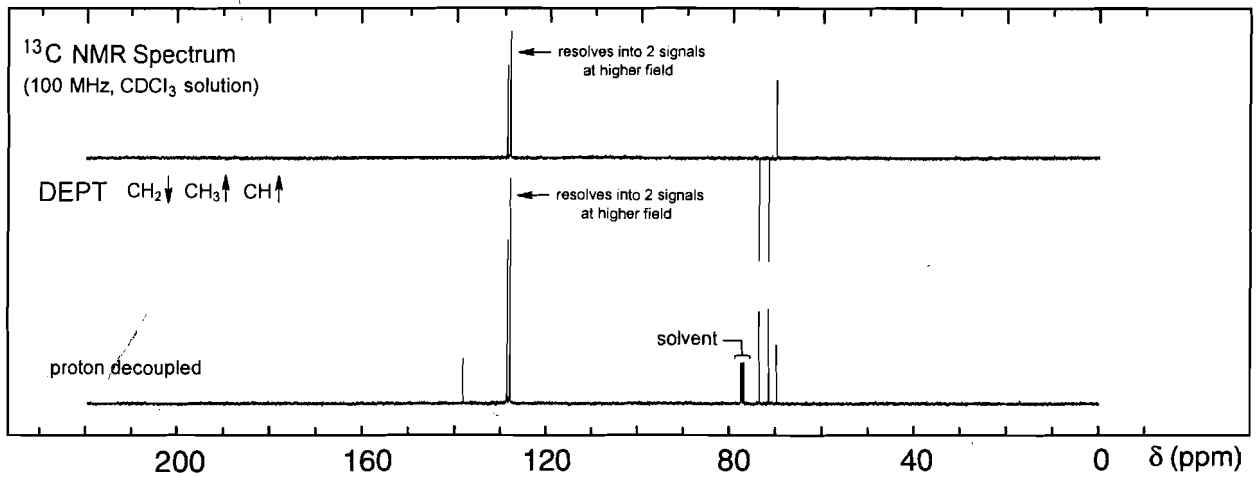

# Problem 224

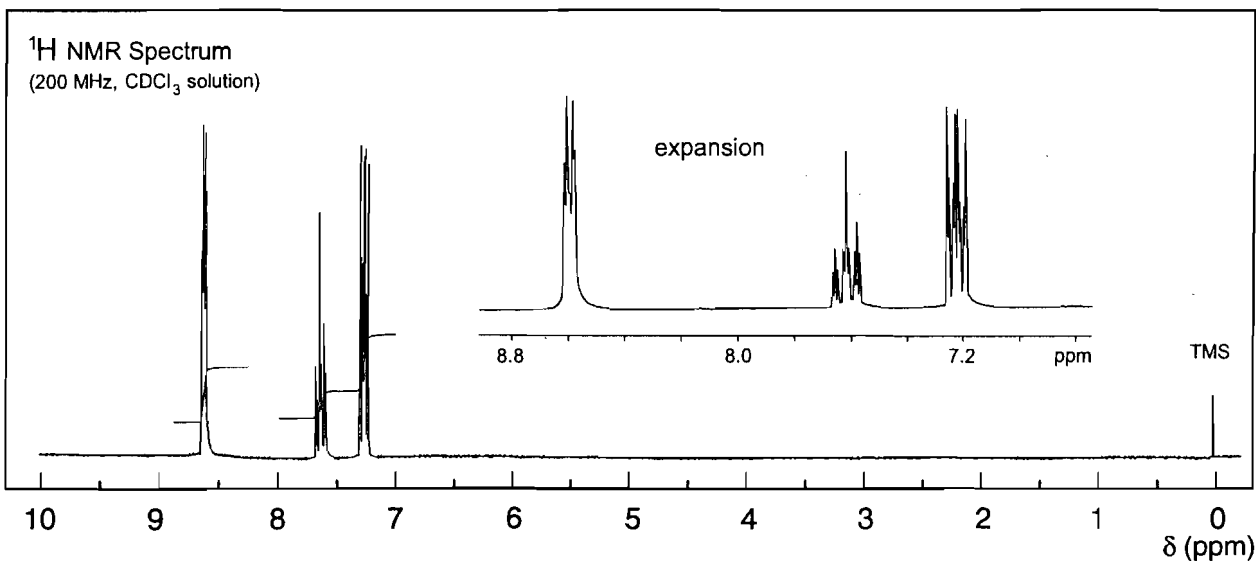
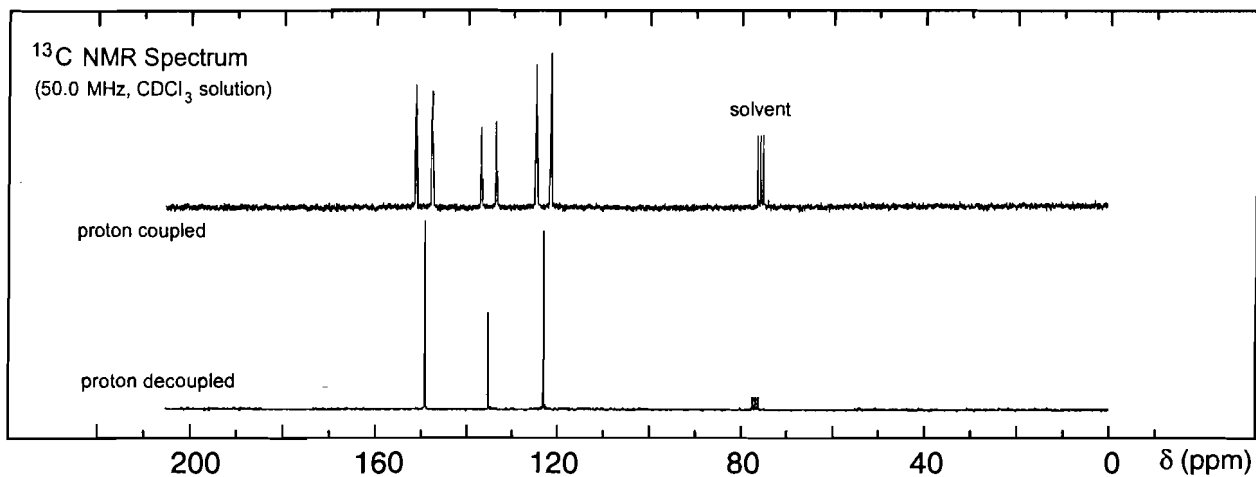
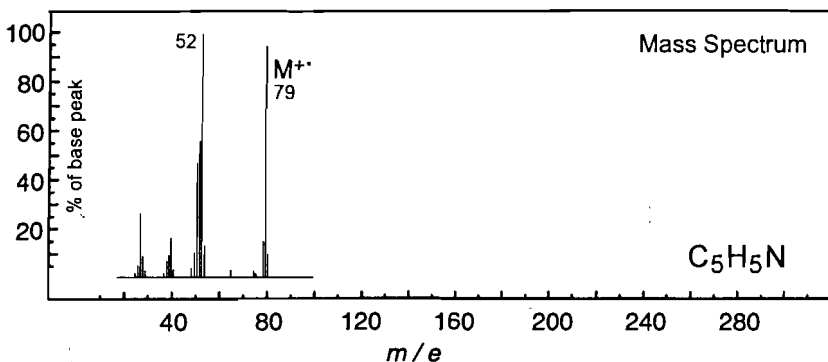
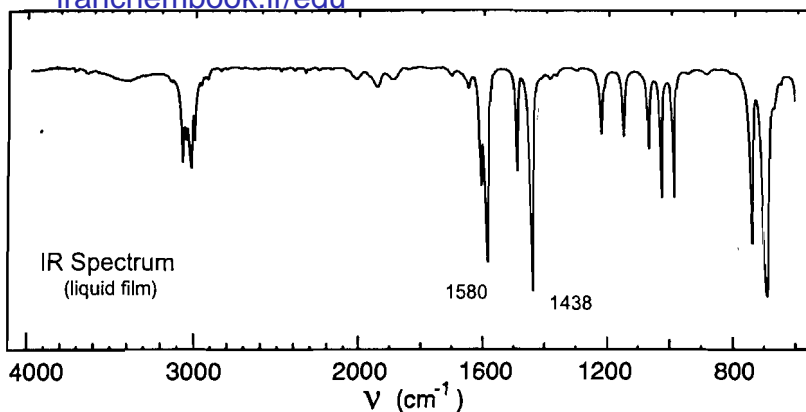

## Problem 225

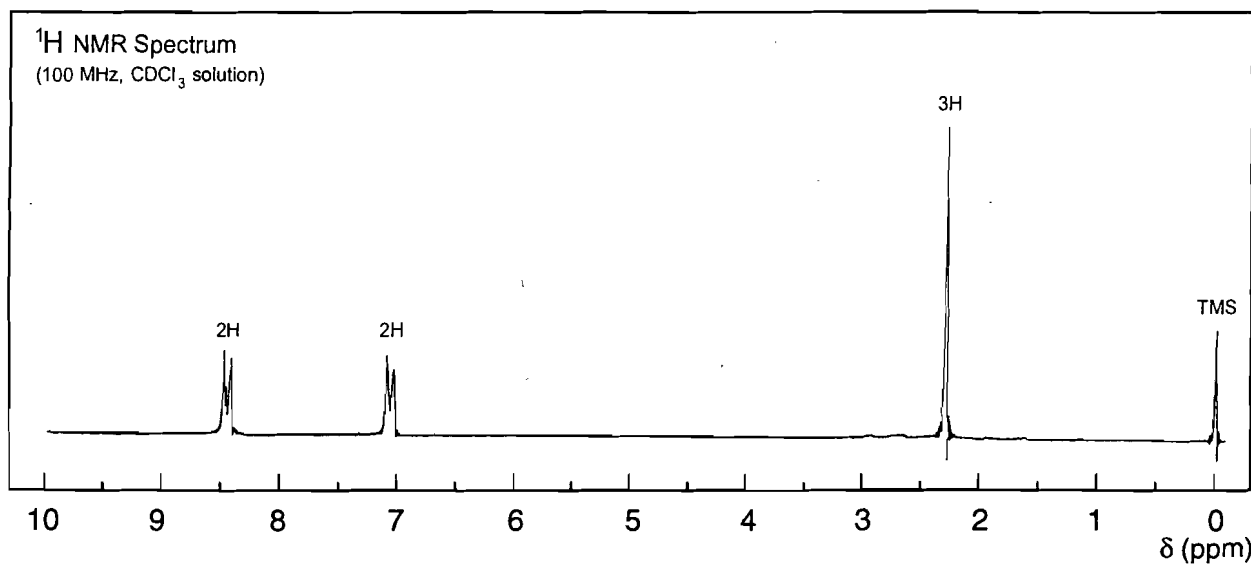
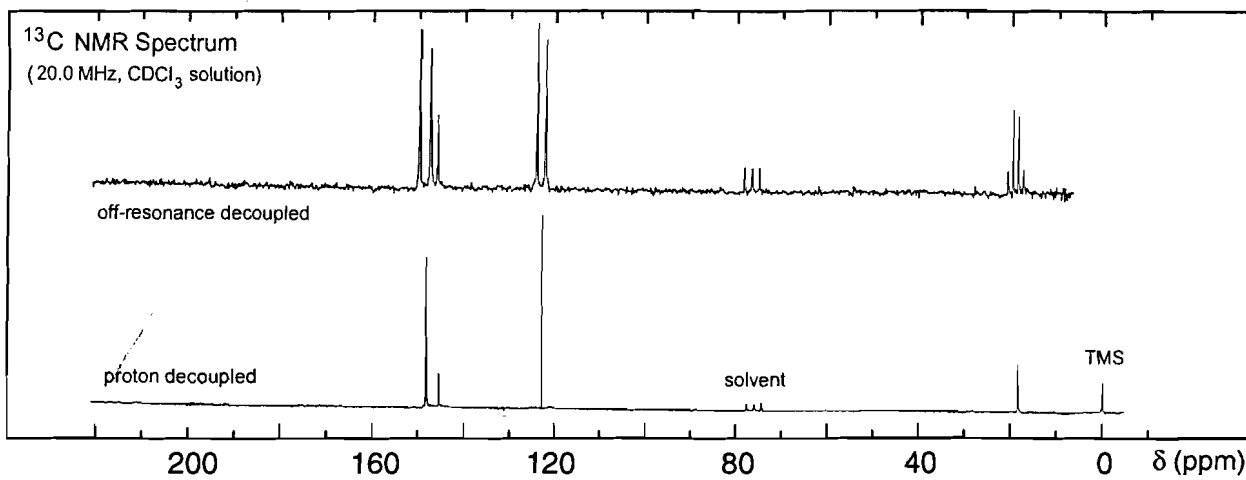
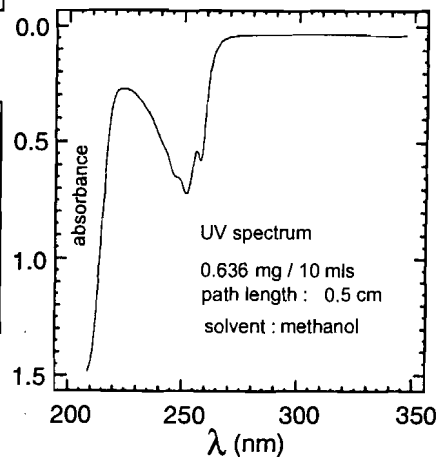
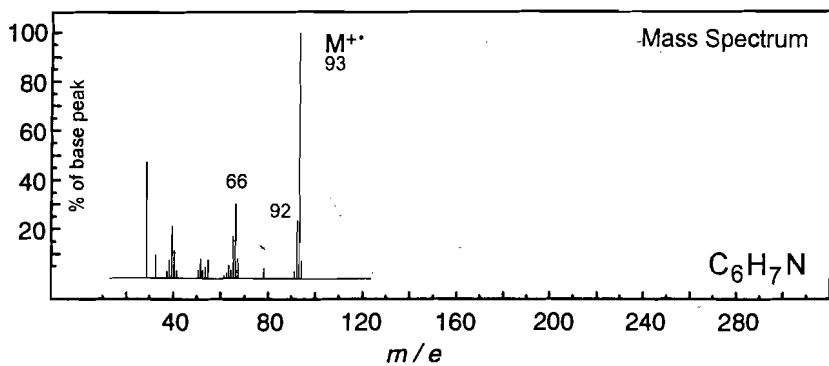
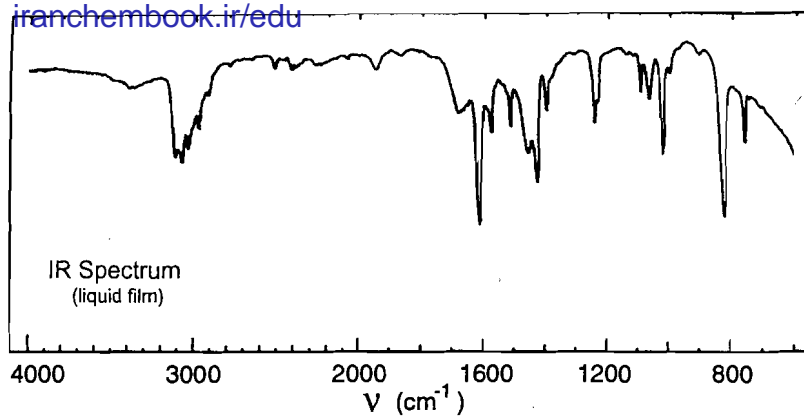

# Problem 226

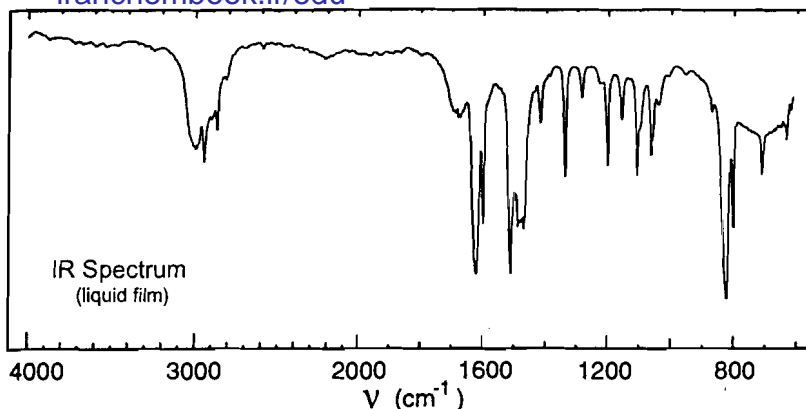

UV Spectrum

$\lambda_{\max}$  262 nm ( $\log_{10} \epsilon$  3.6)

solvent : methanol

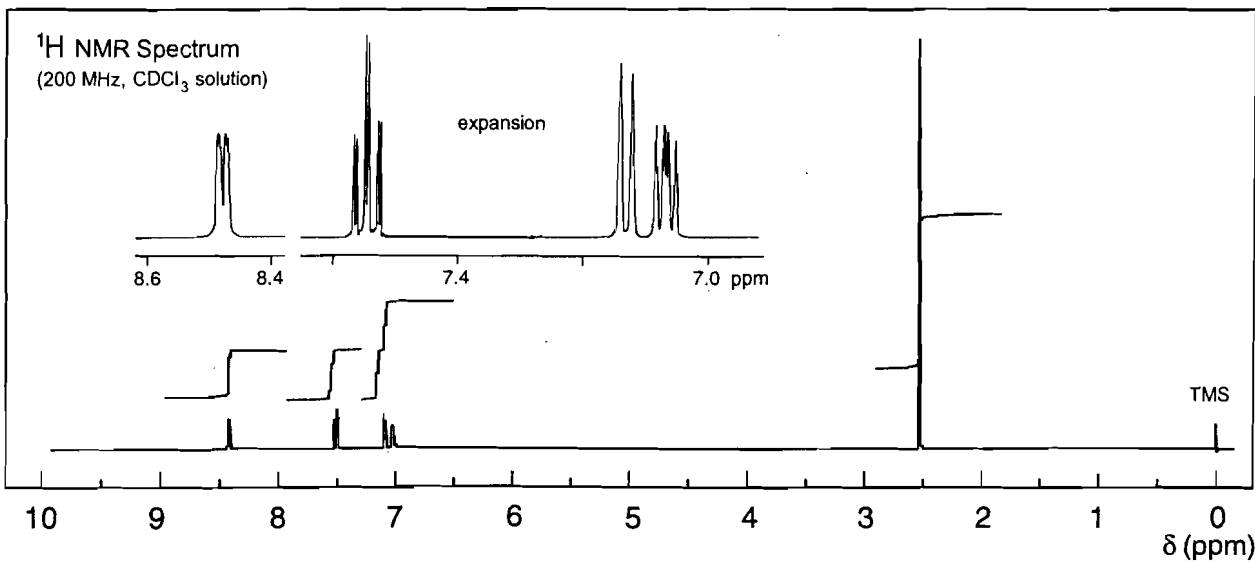
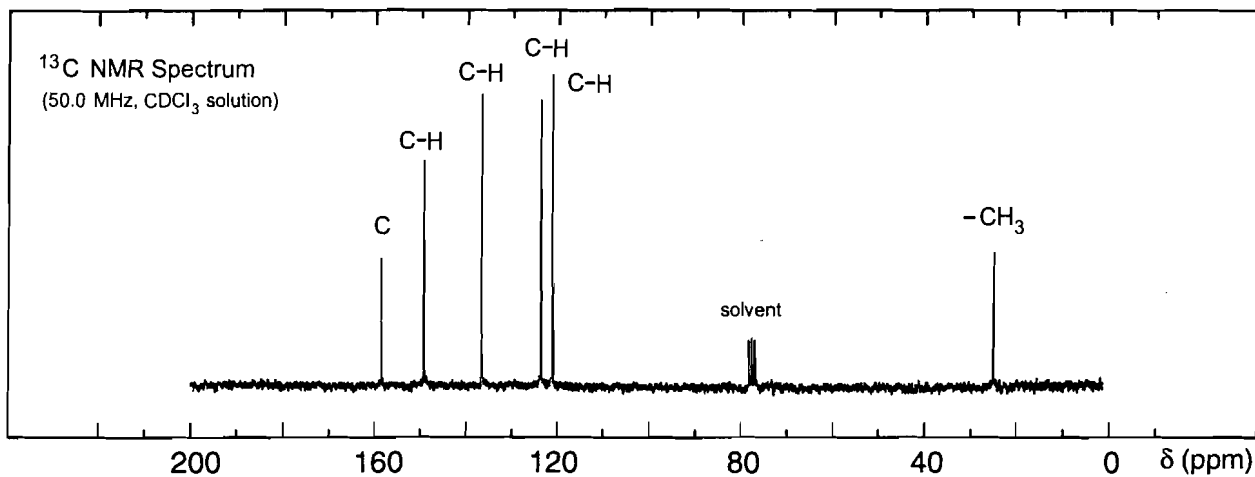
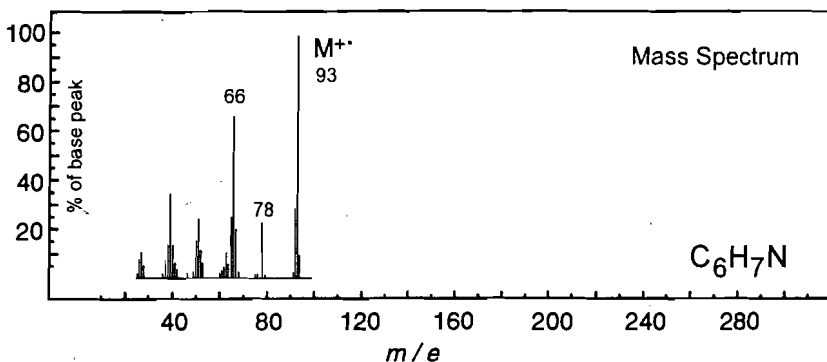

## Problem 227

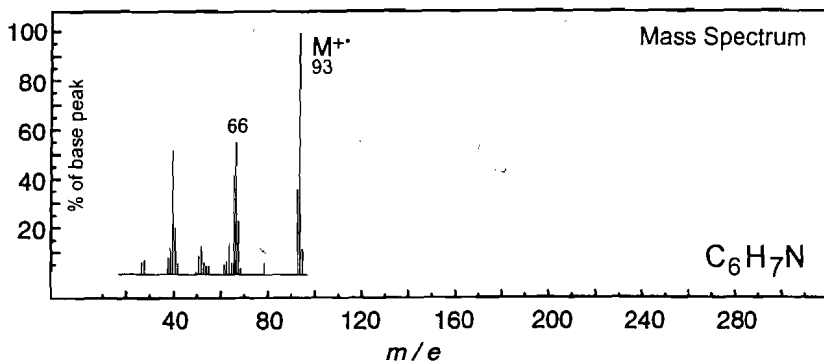
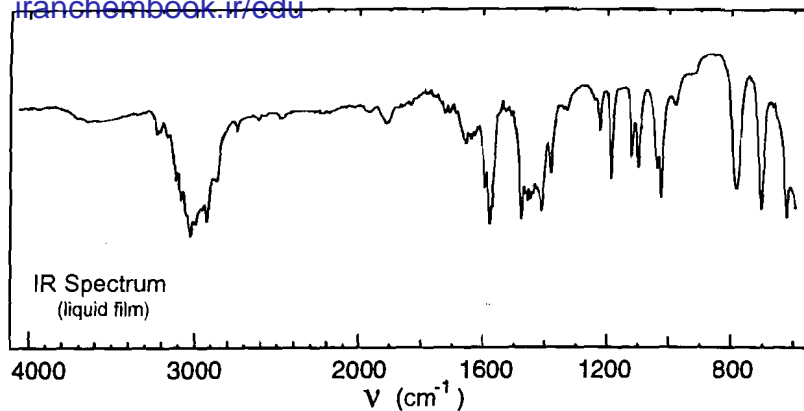

UV Spectrum

 $\lambda_{\max}$  263 nm ( $\log_{10} \epsilon$  3.5)

solvent: methanol

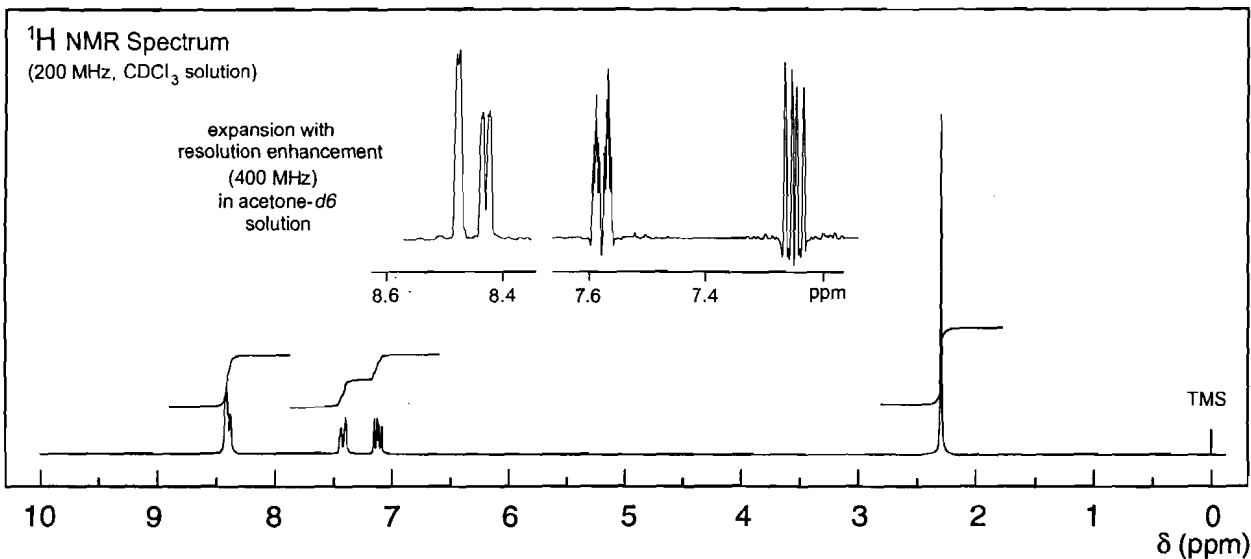
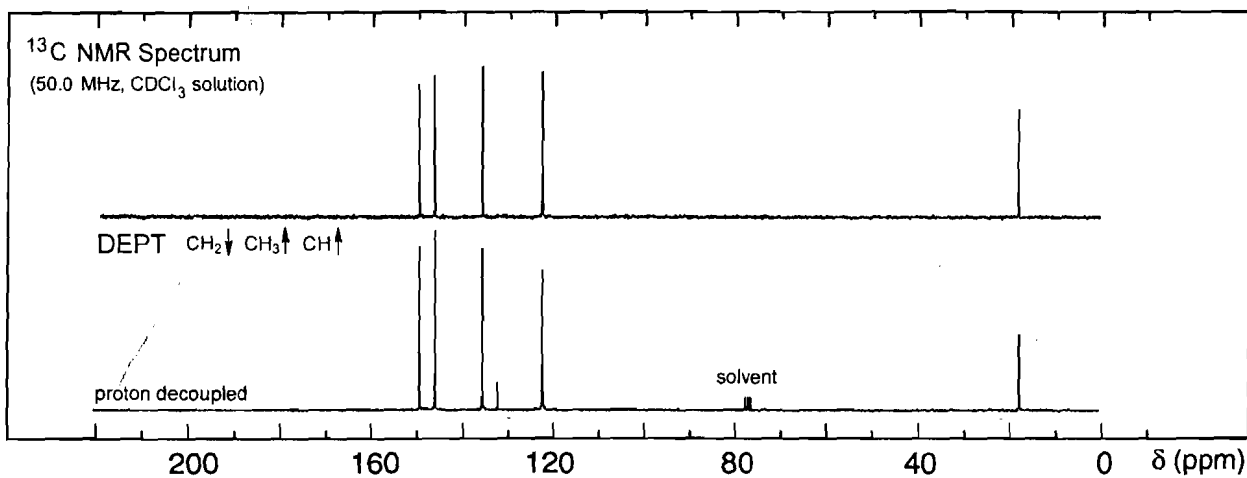

# Problem 228

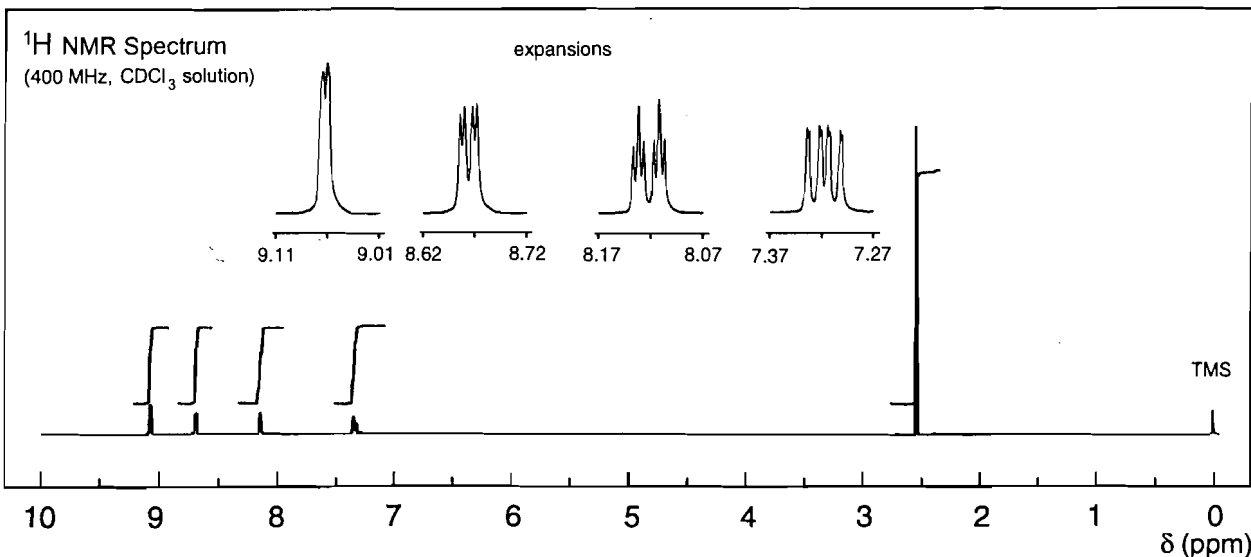
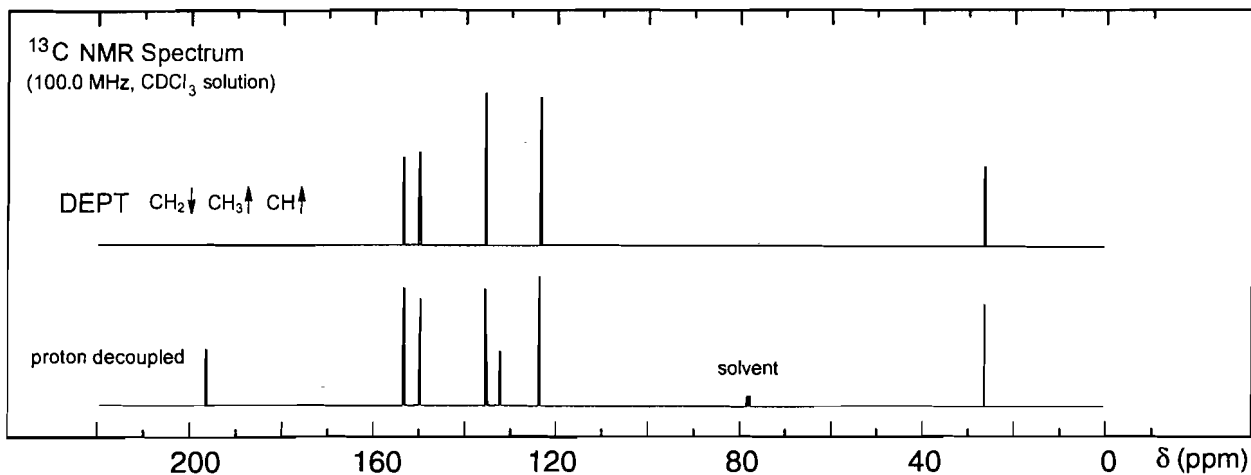
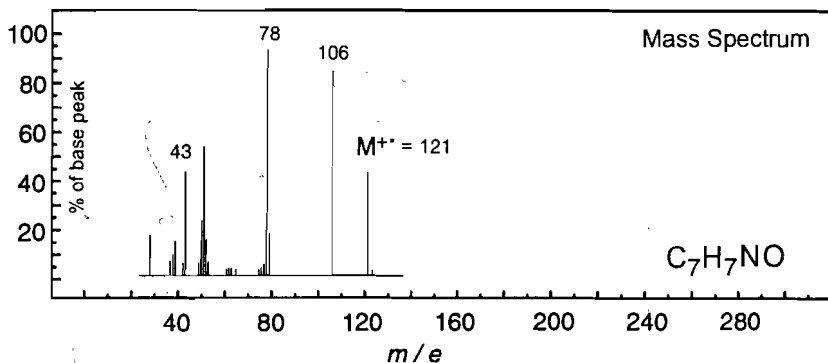
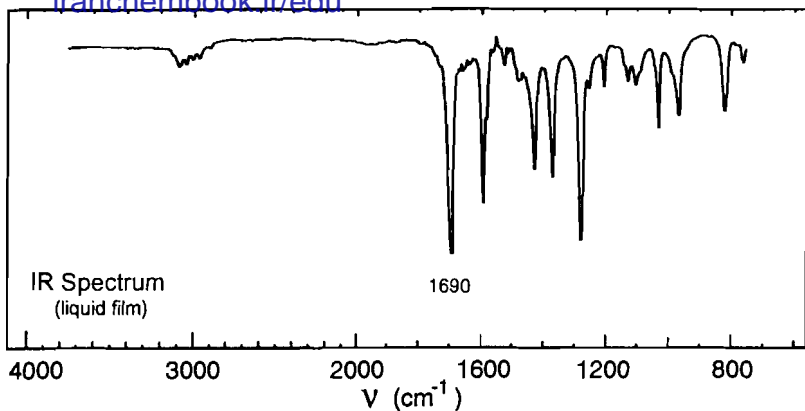

# Problem 229

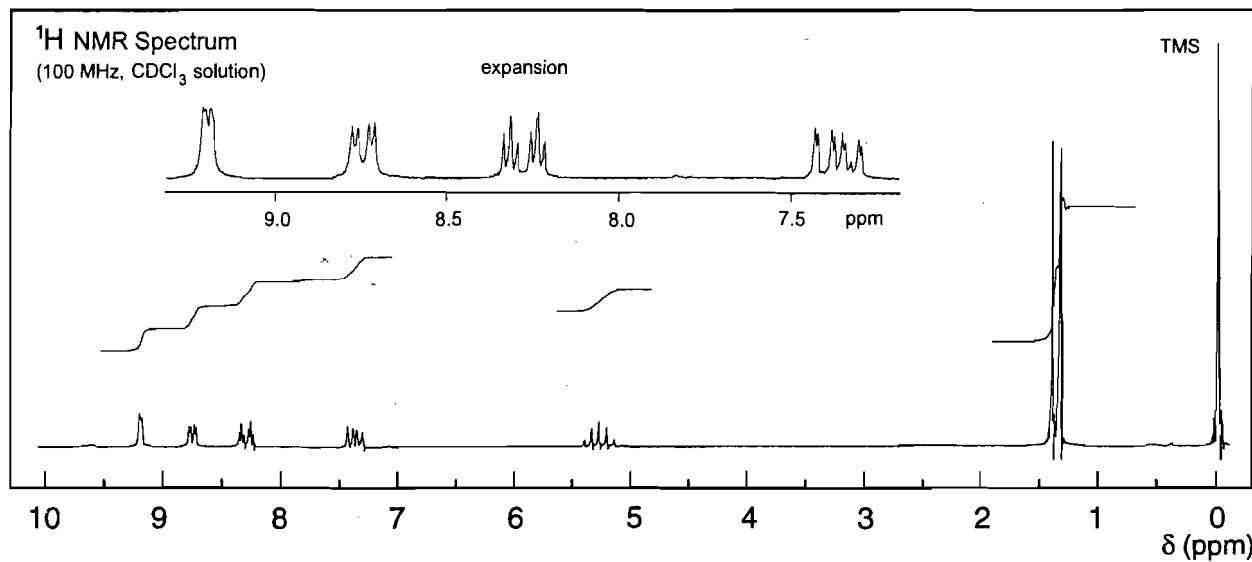
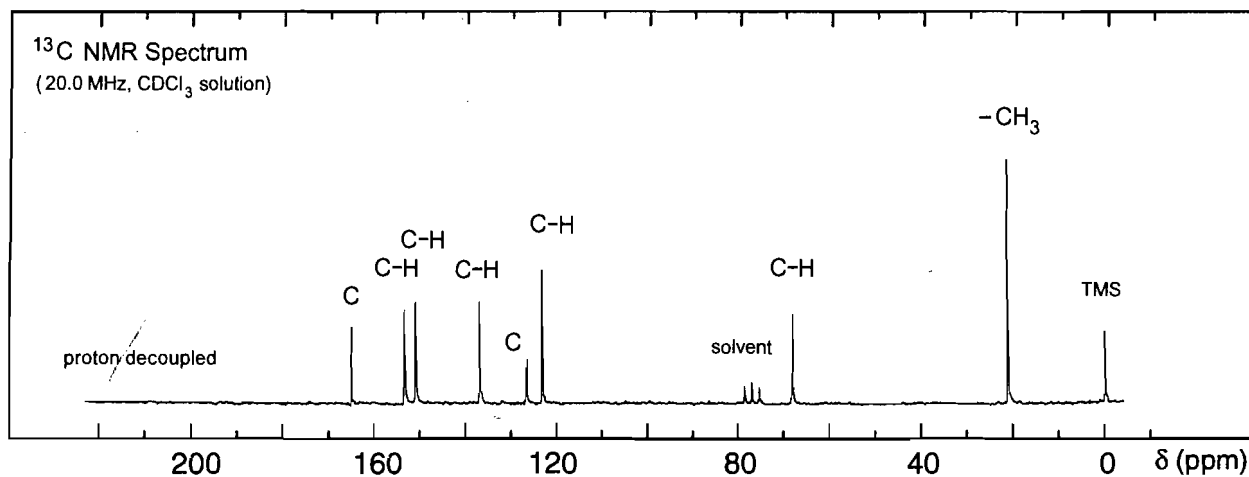
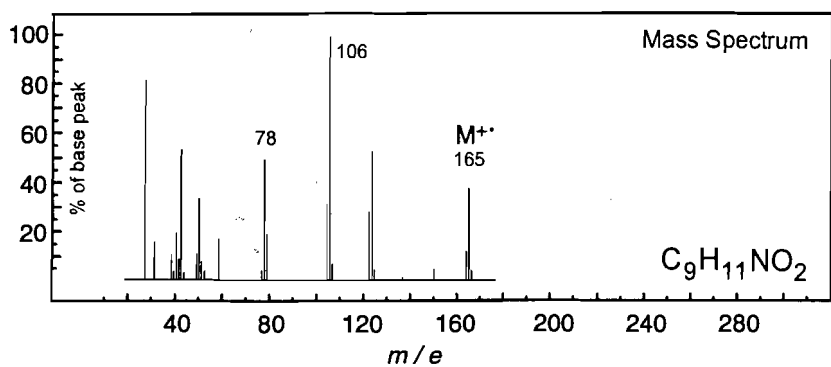
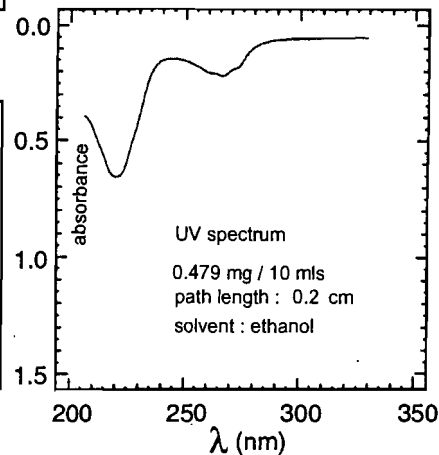
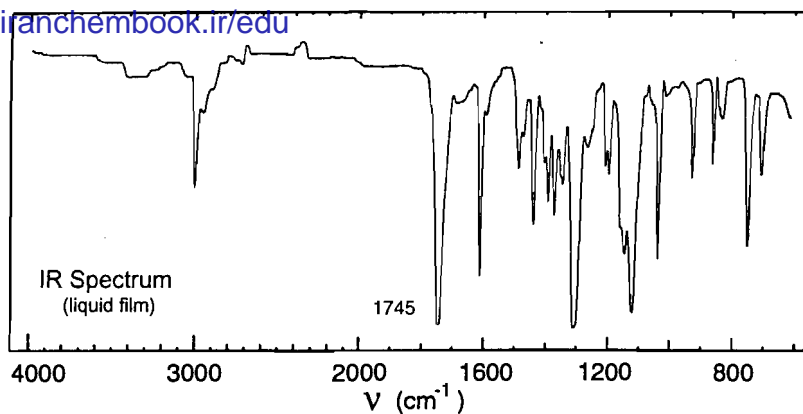

## Problem 230

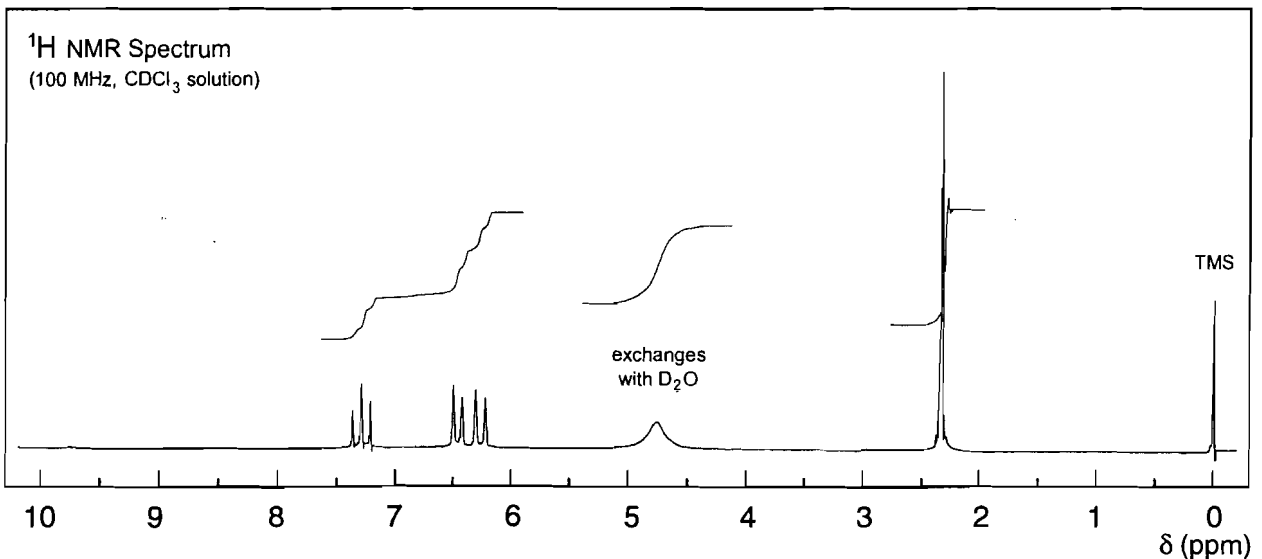
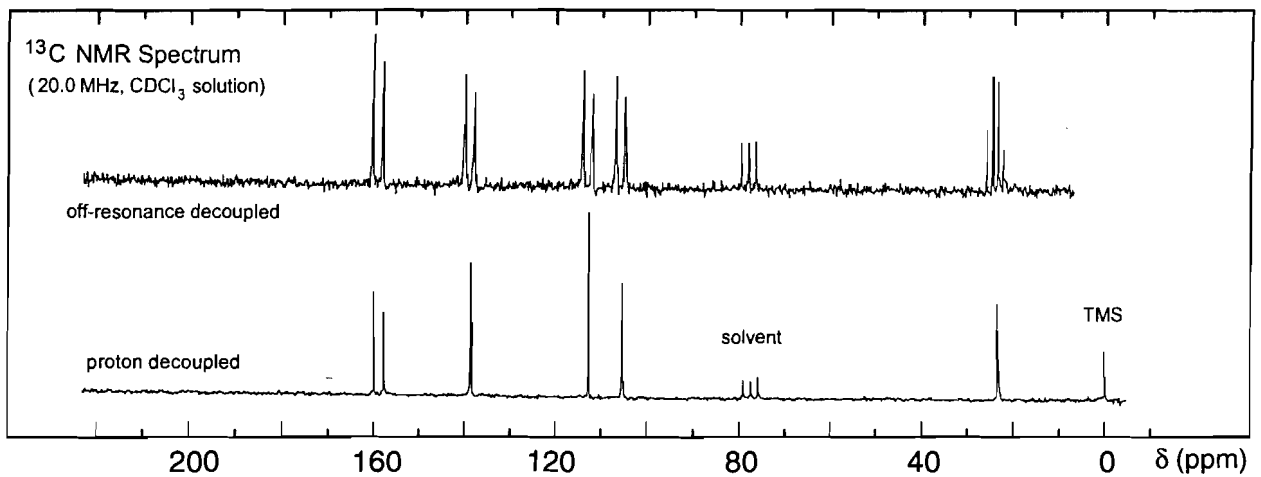
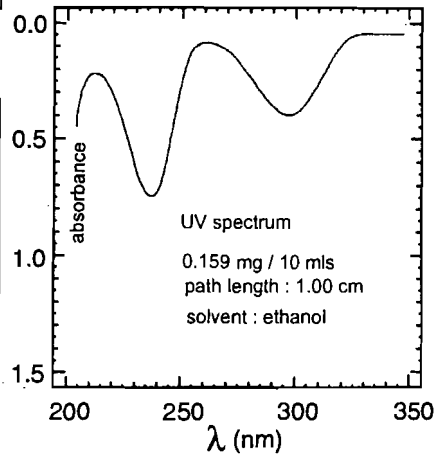
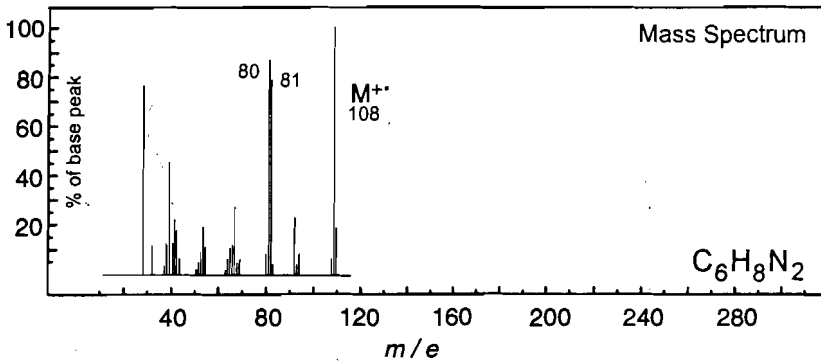
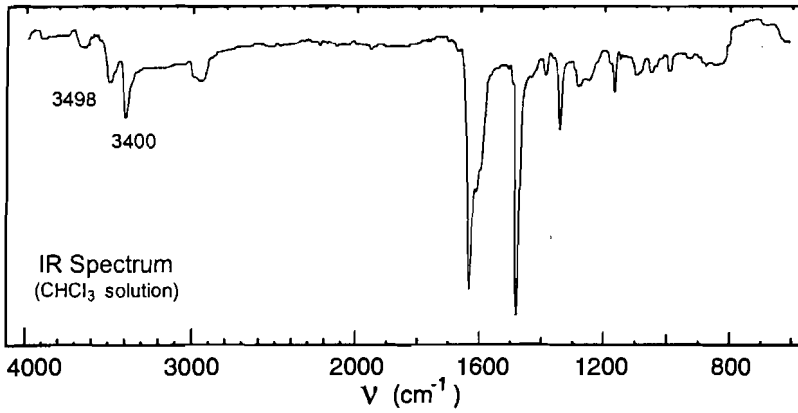



# Problem 231

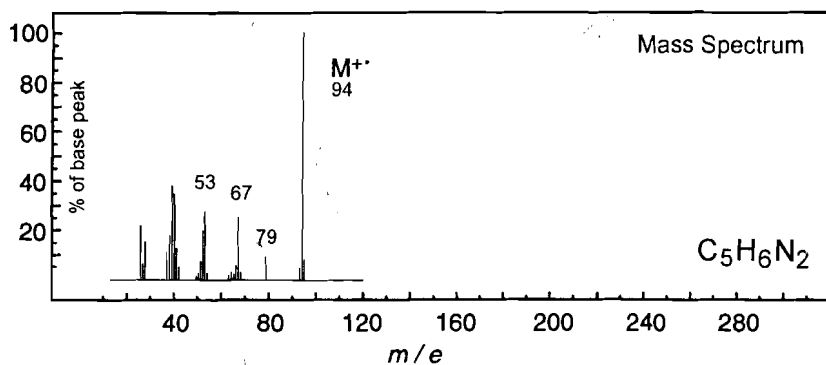
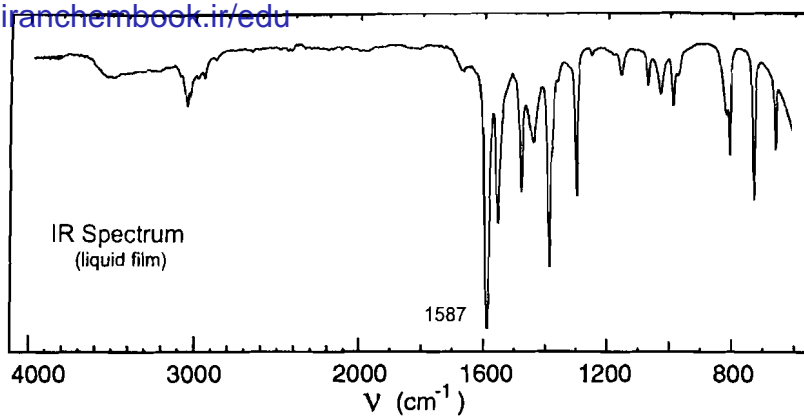

UV Spectrum

$\lambda_{\text{max}}$  270 nm ( $\log_{10} \epsilon$  2.5)

$\lambda_{\text{max}}$  240 nm ( $\log_{10} \epsilon$  3.4)

solvent : methanol

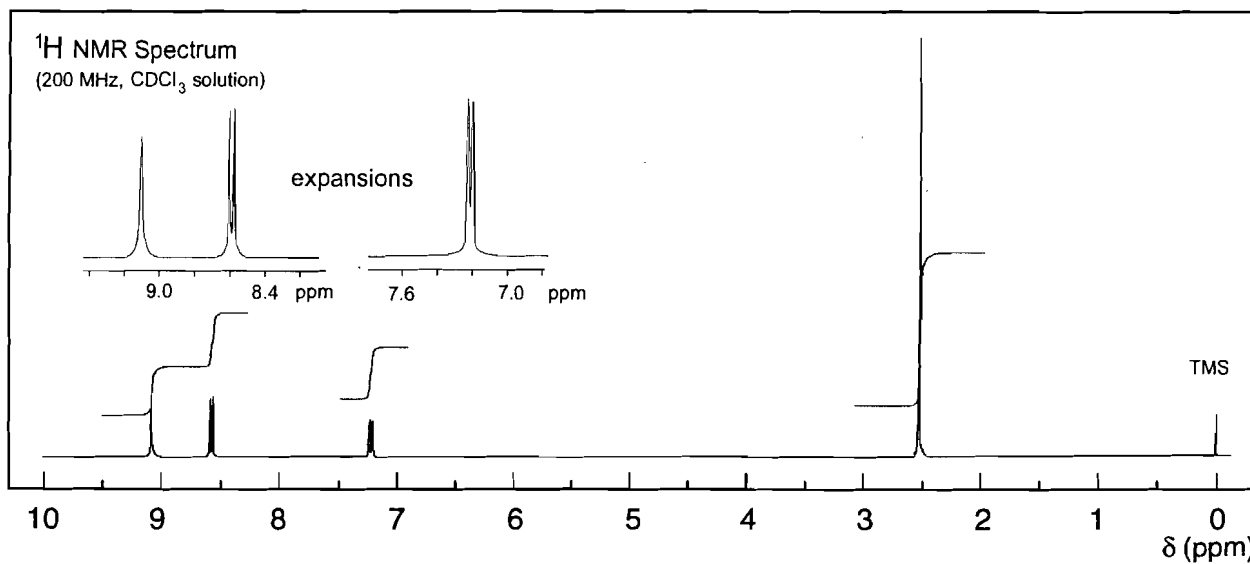
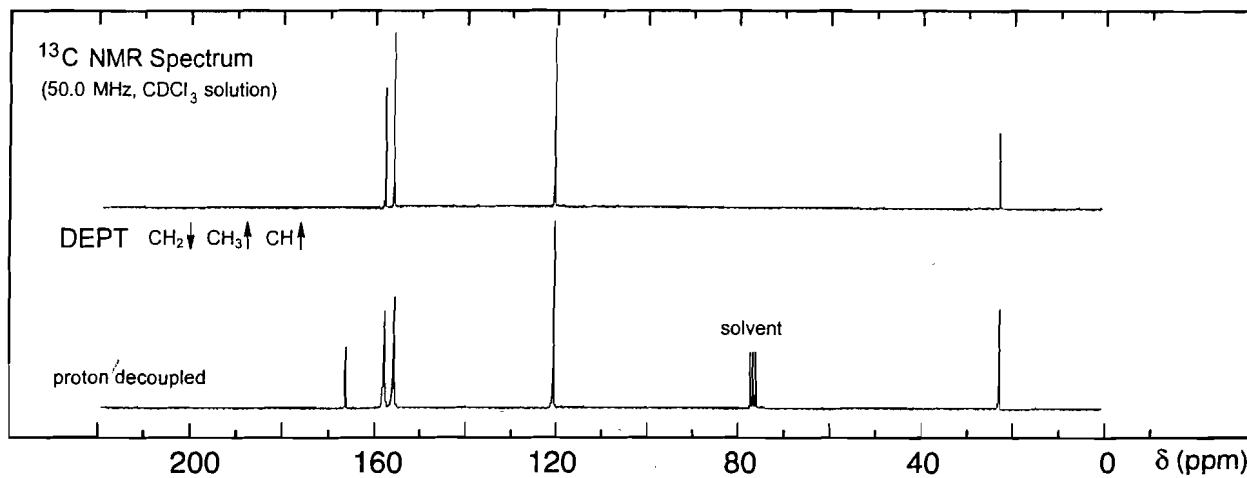

## Problem 232

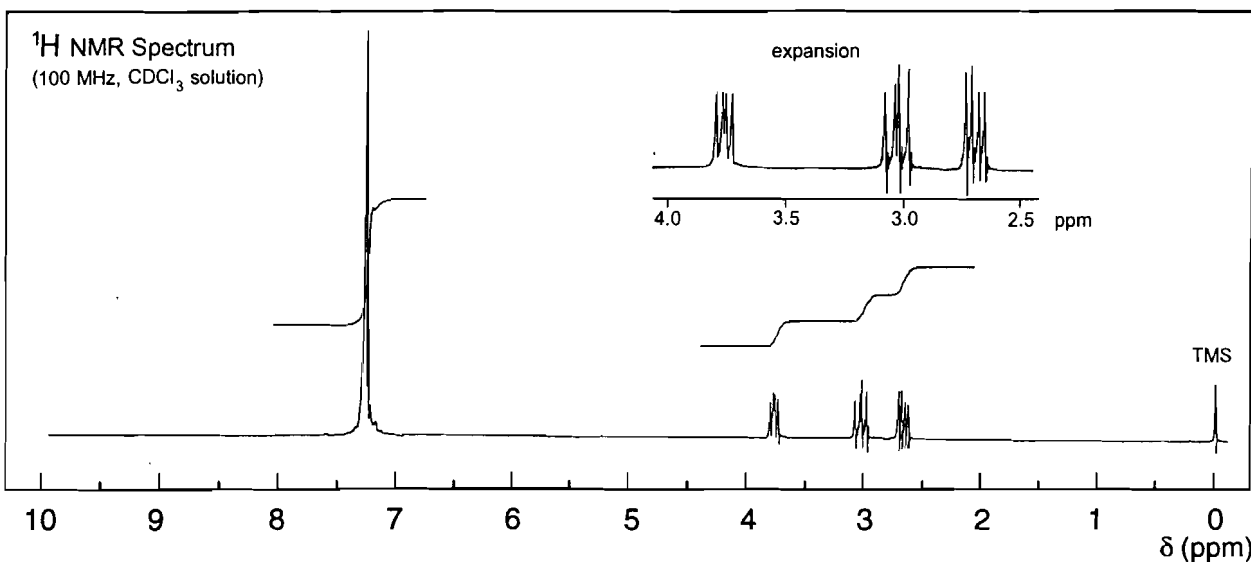
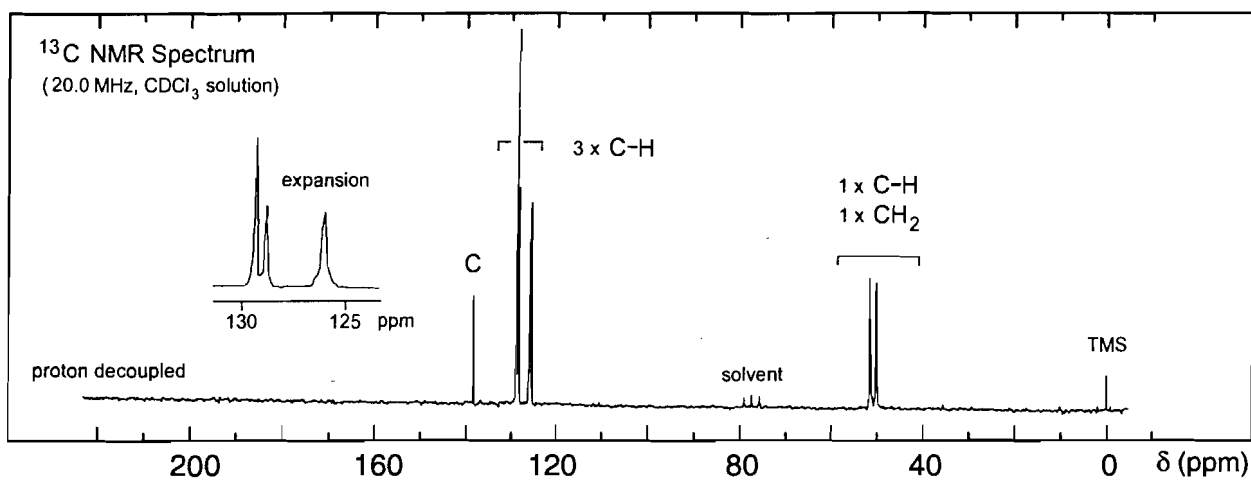
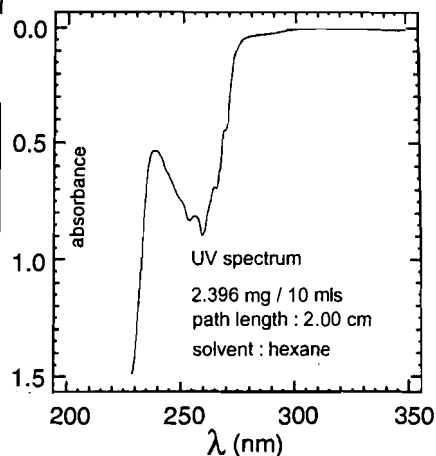
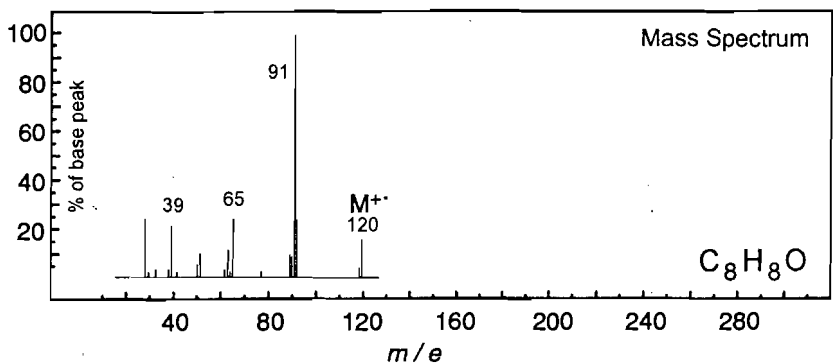
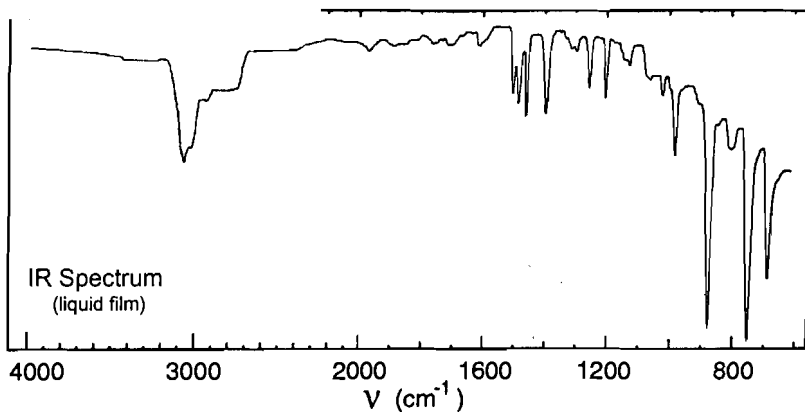

## Problem 233

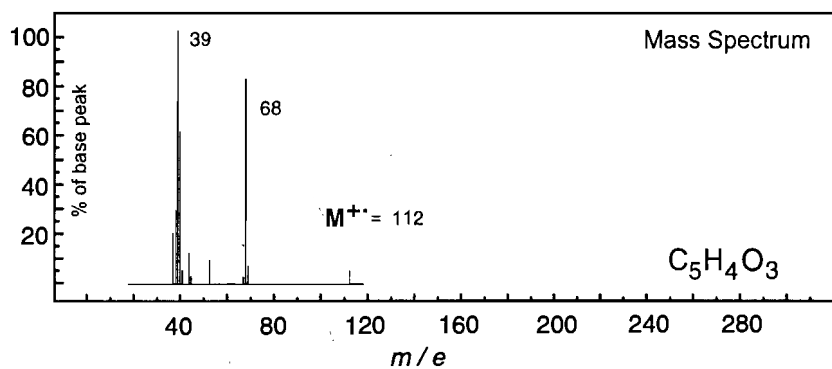
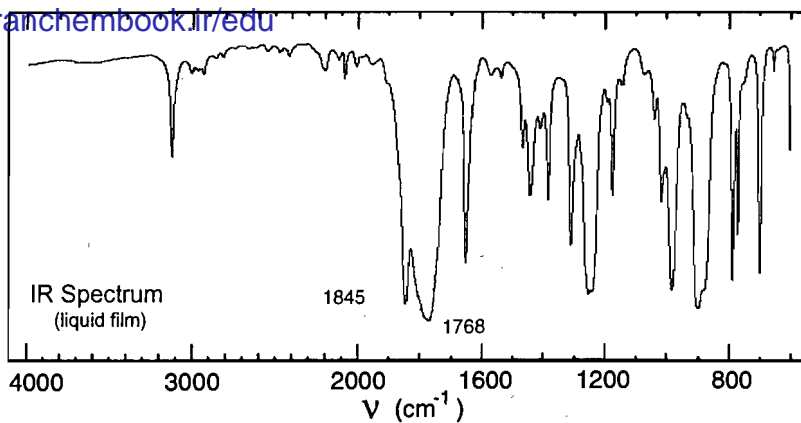

UV Spectrum

 $\lambda_{\text{max}}$  217 nm ( $\log_{10} \epsilon$  4.1)

solvent: methanol

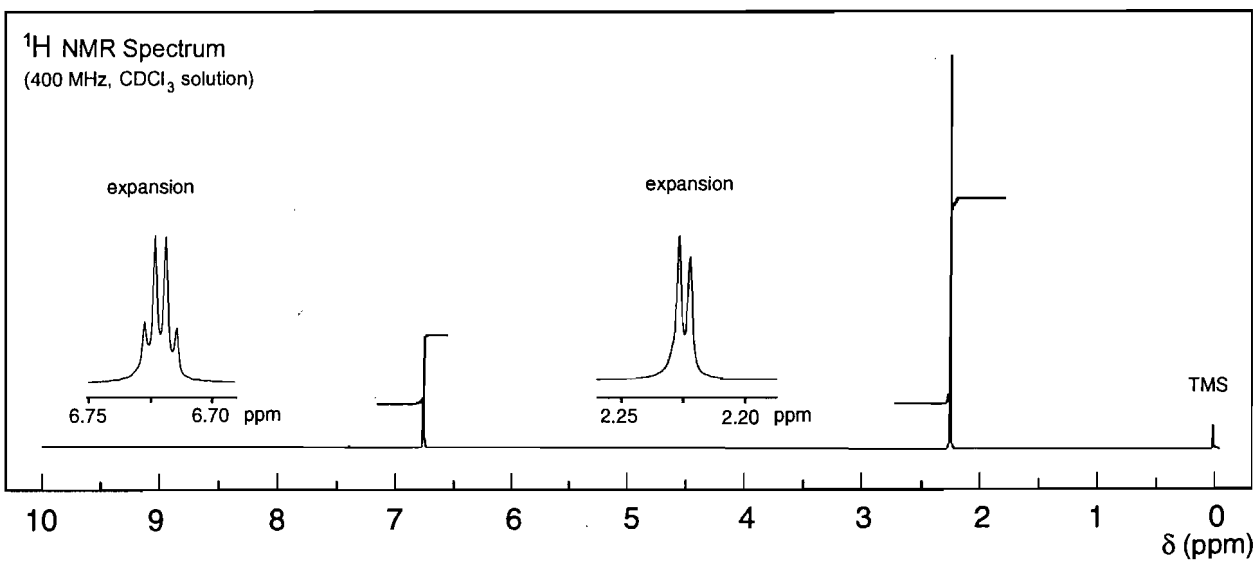
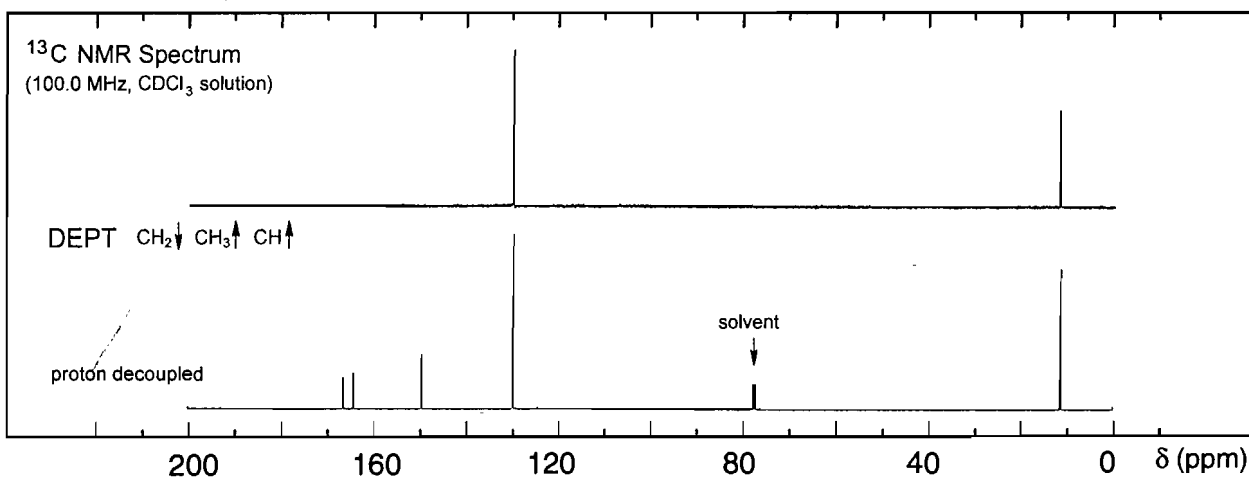

## Problem 234

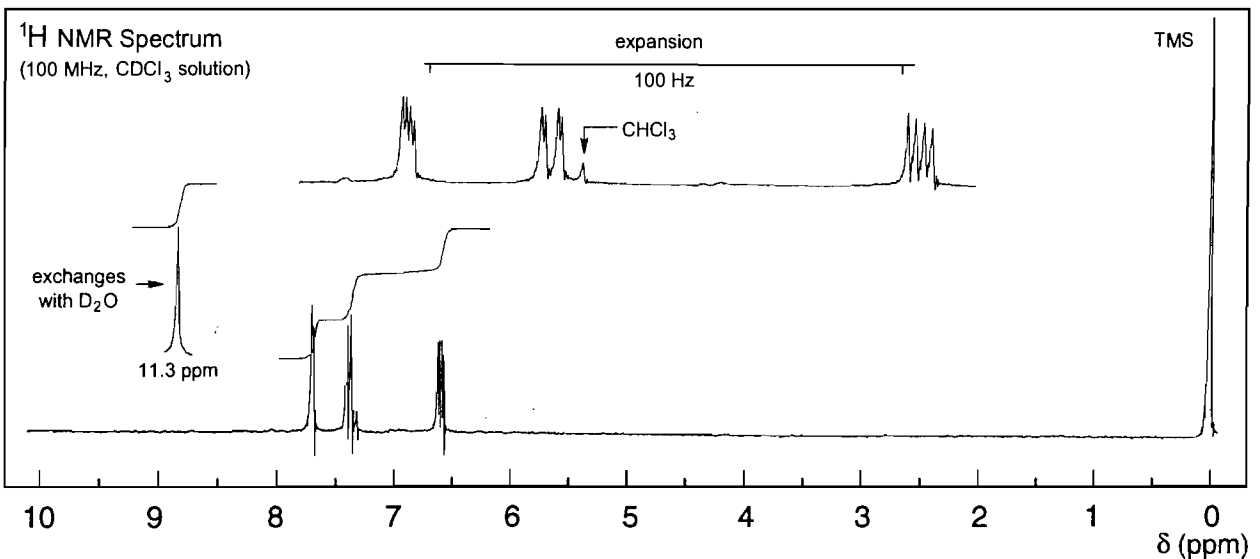
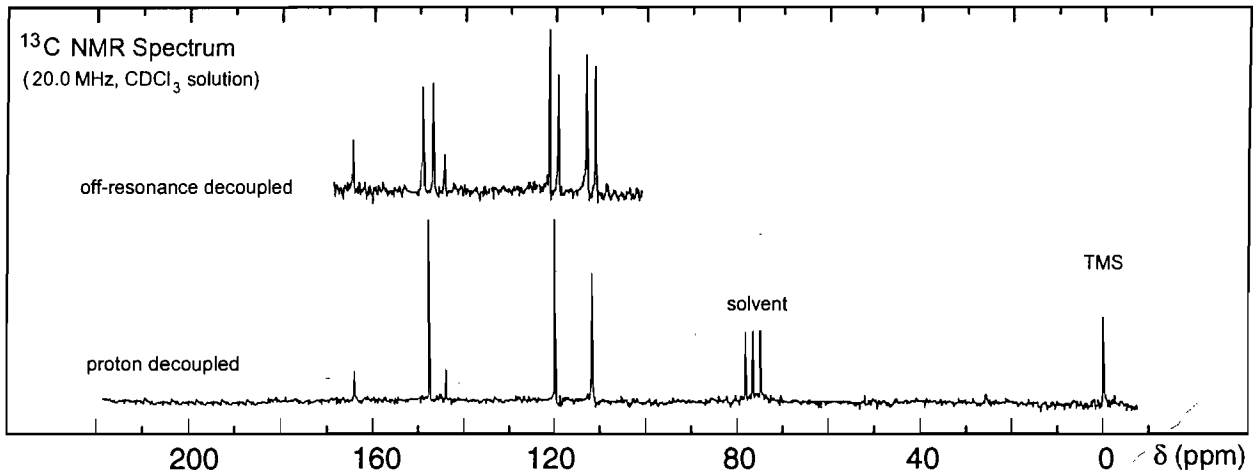
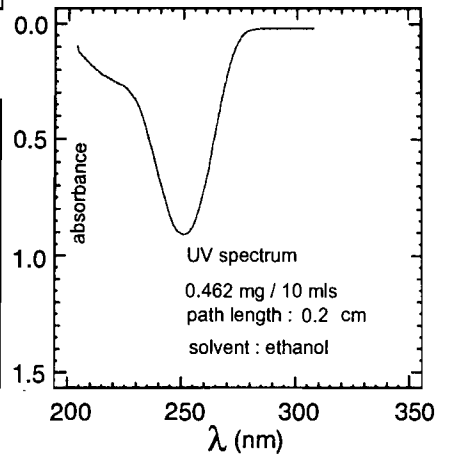
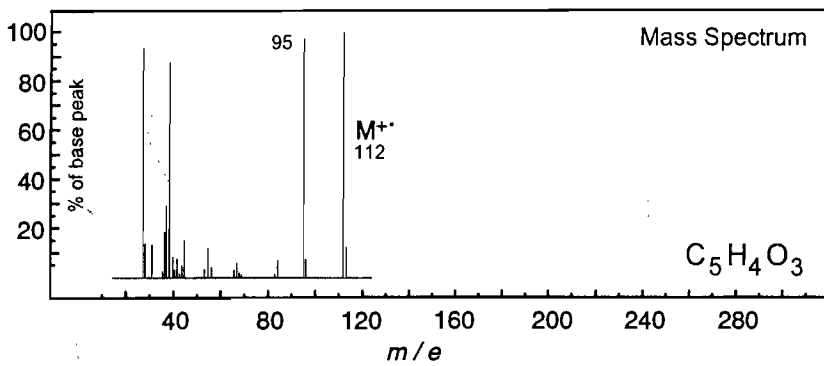
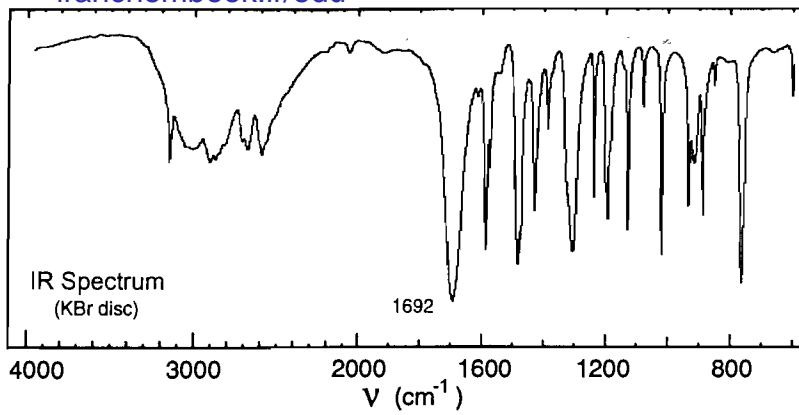

## Problem 235

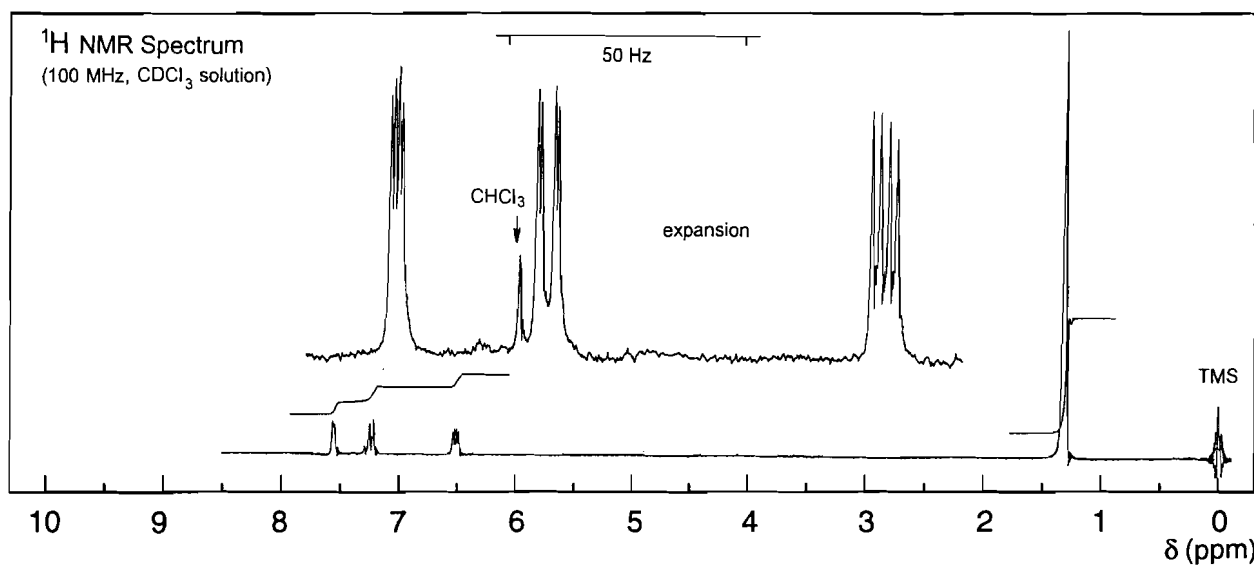
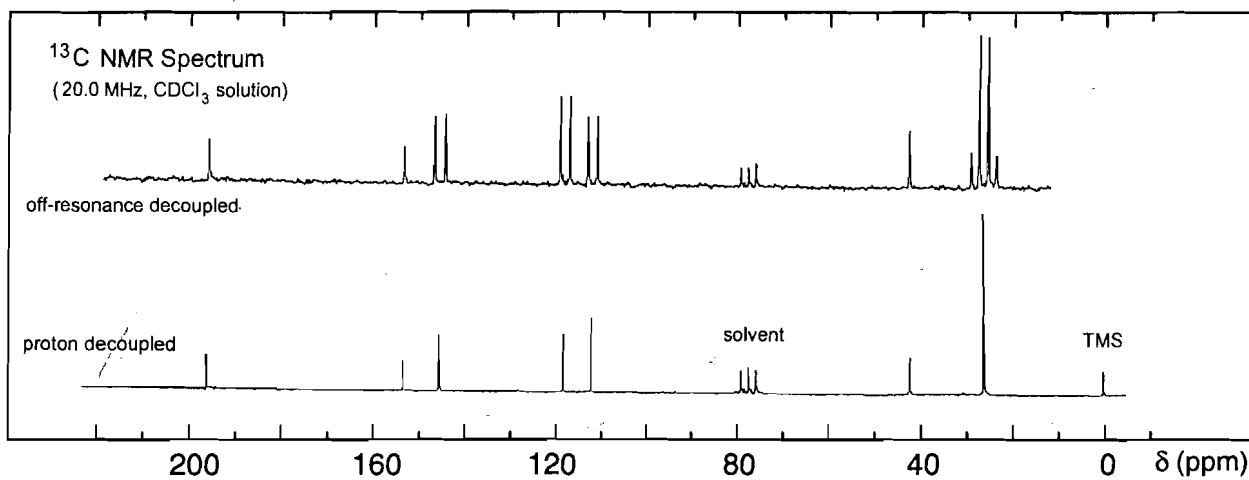
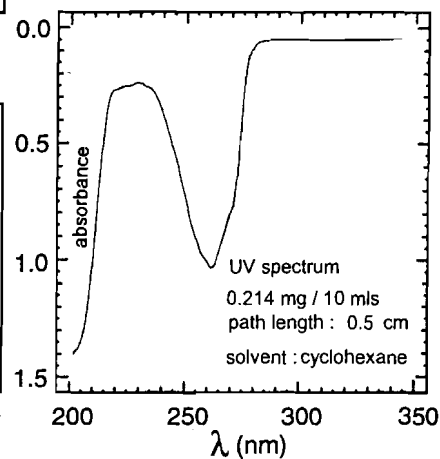
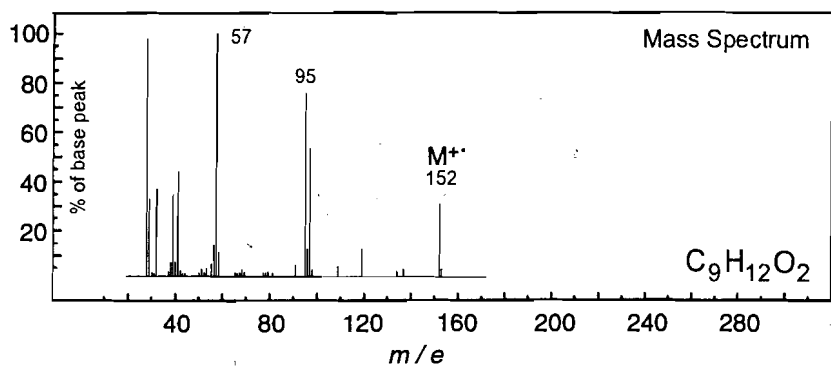
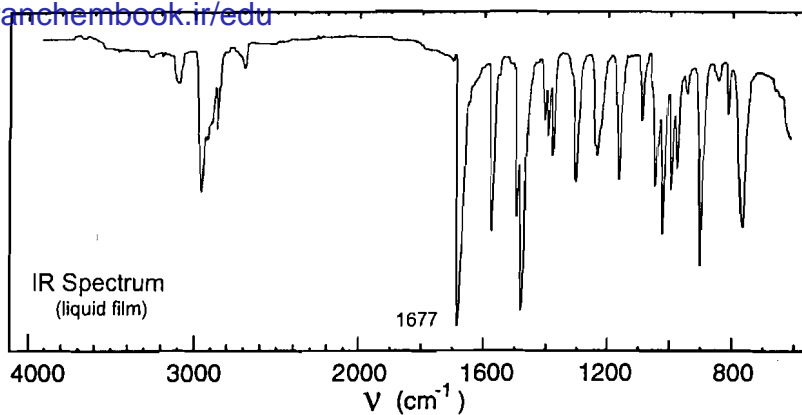

## Problem 236

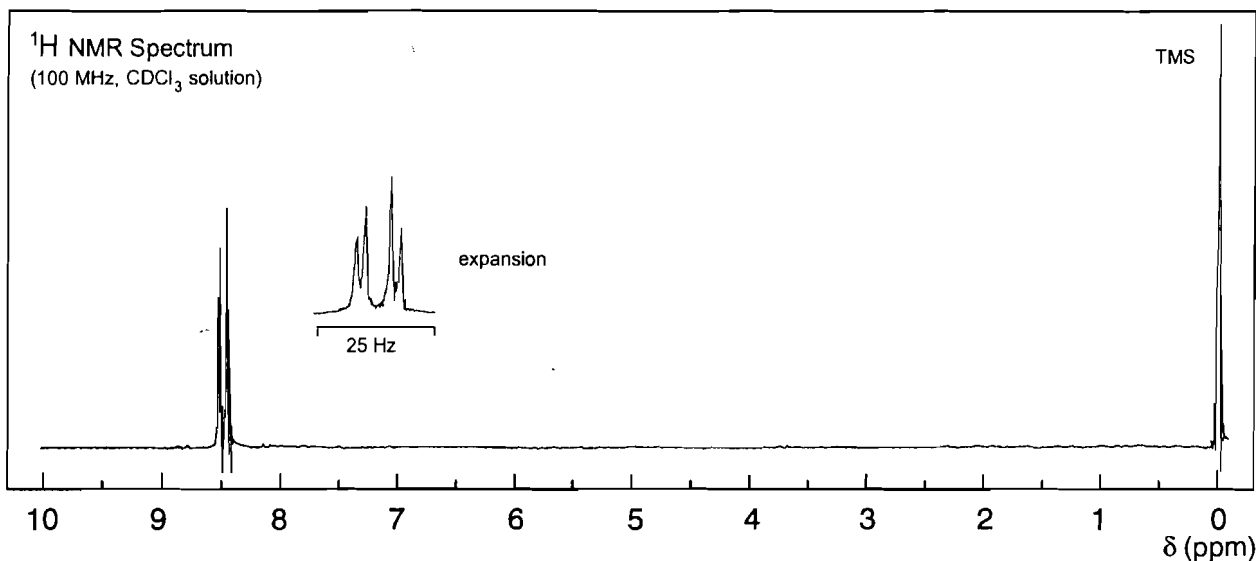
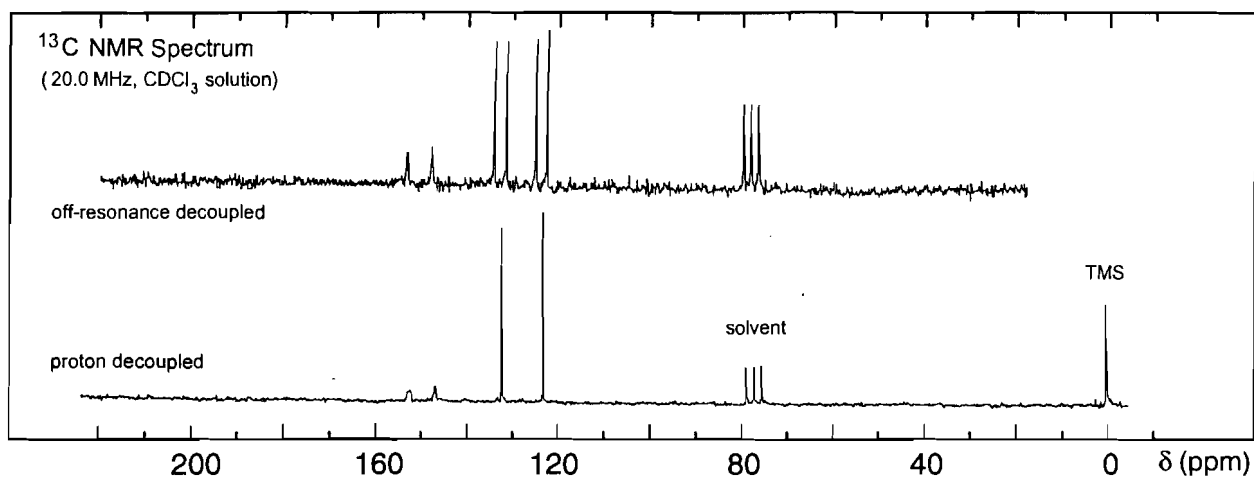
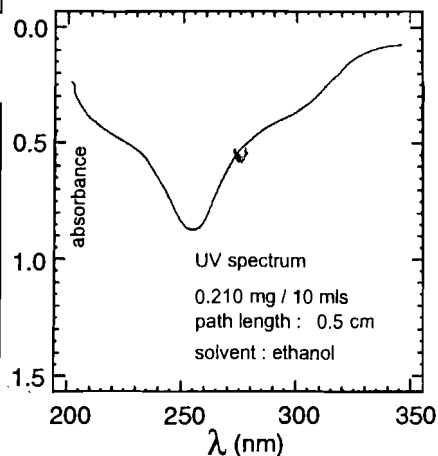
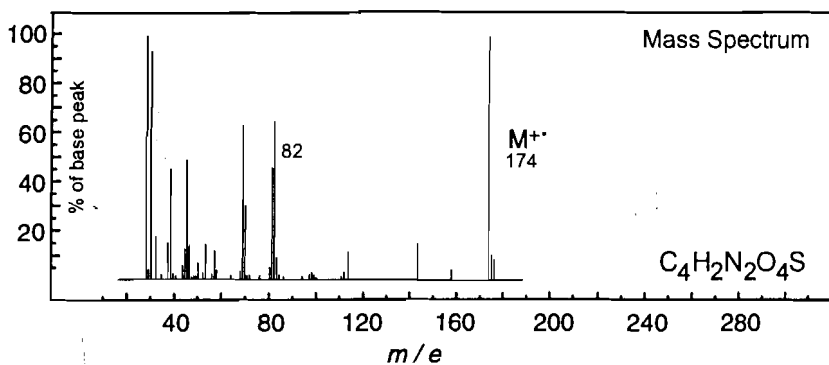
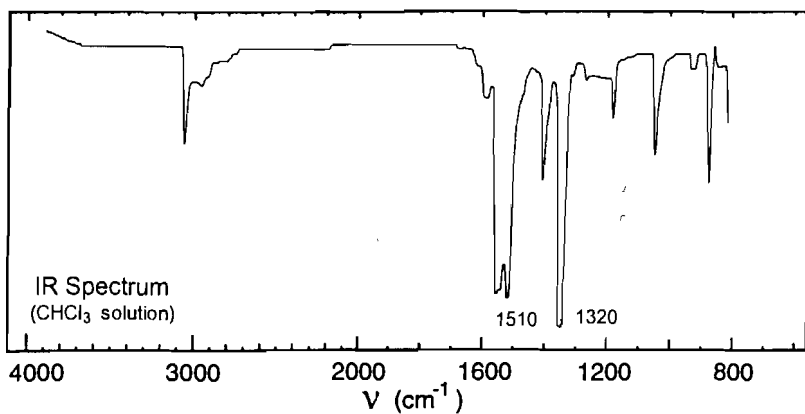

## Problem 237

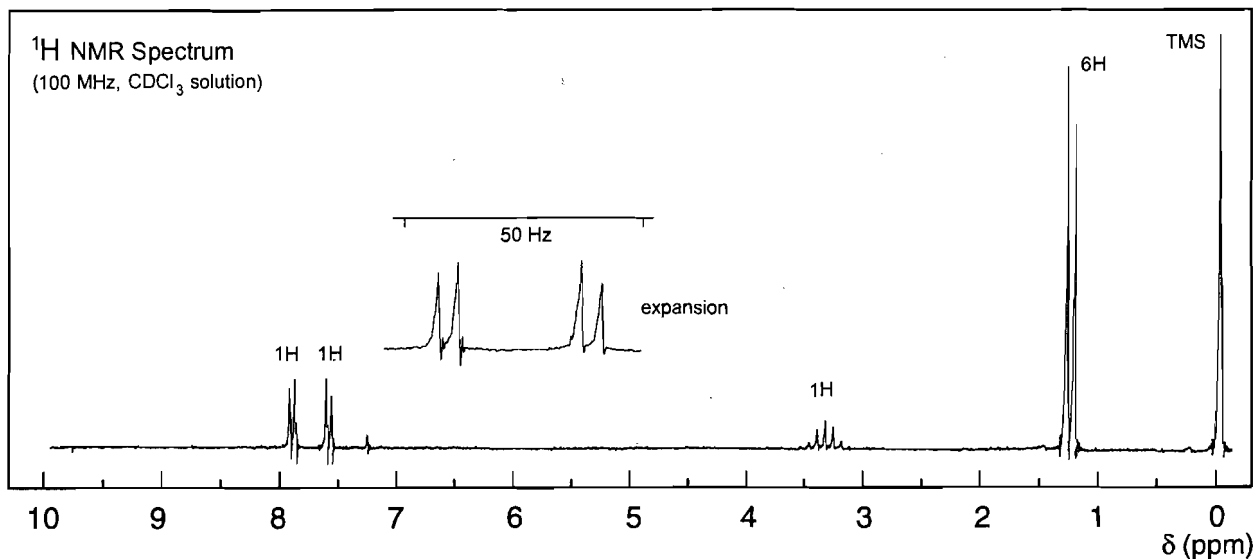
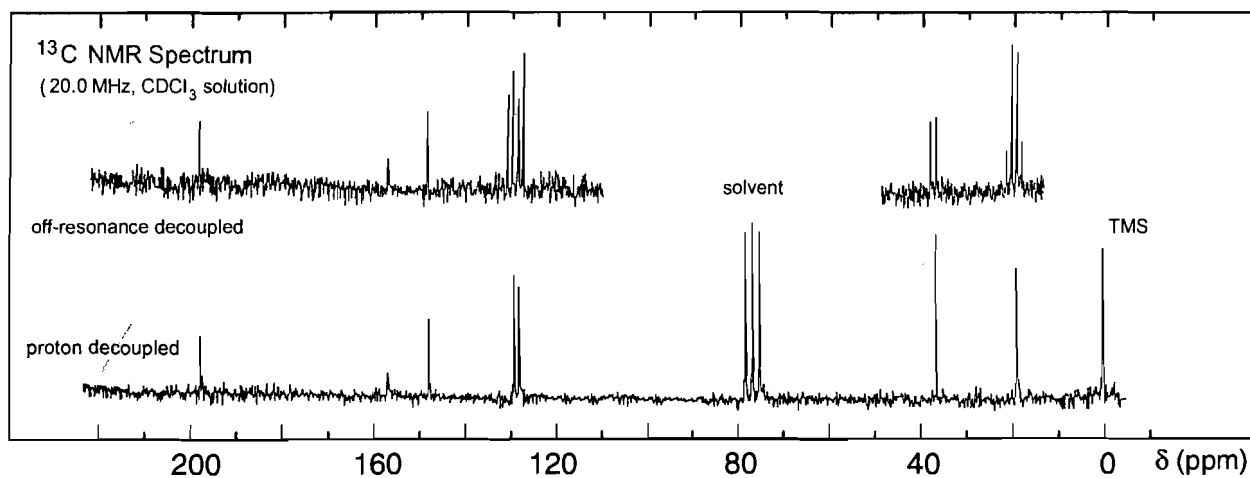
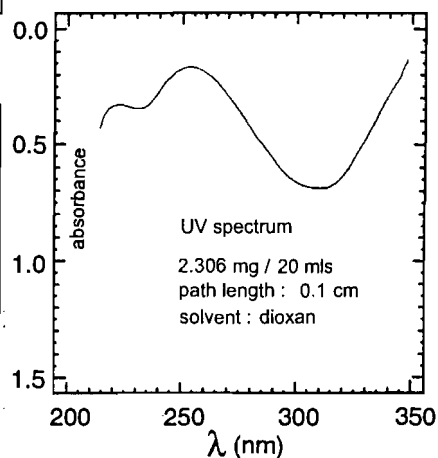
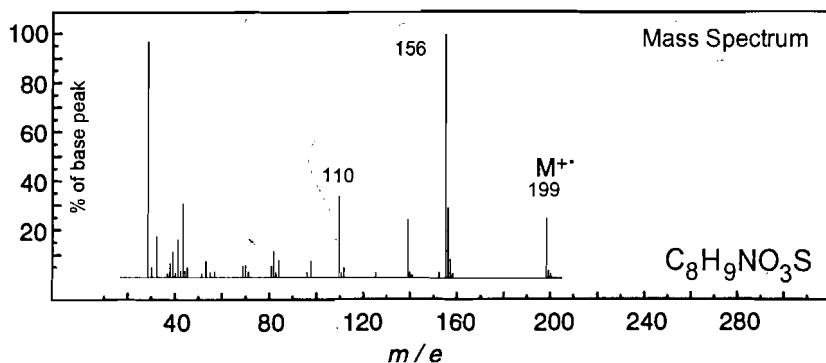
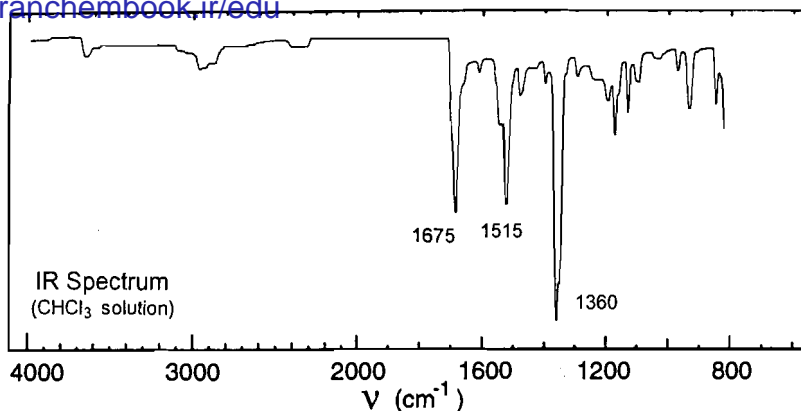

## Problem 238

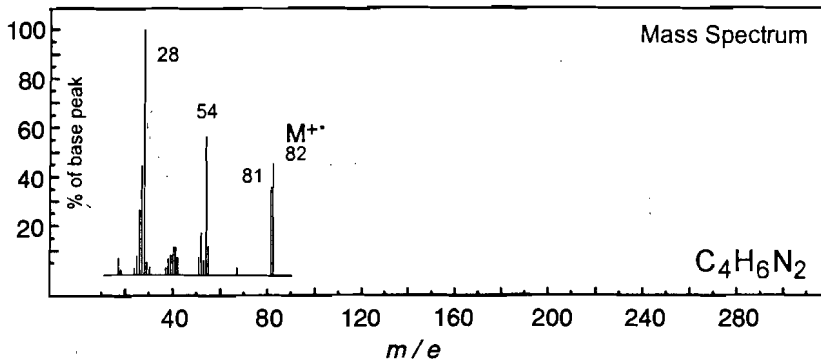
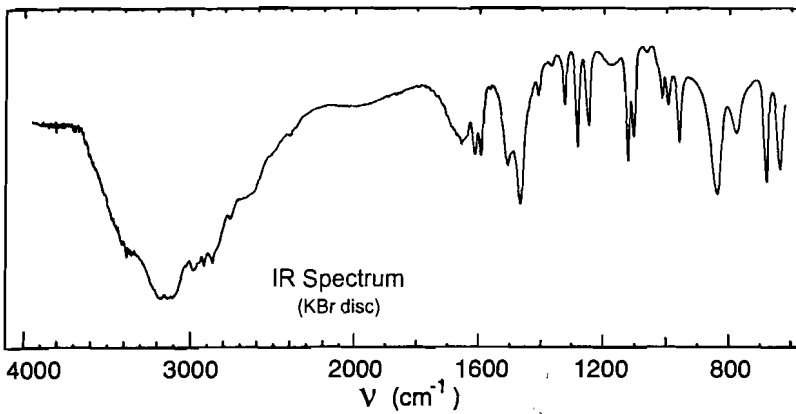

UV Spectrum

 $\lambda_{\max}$  213 nm ( $\log_{10} \epsilon$  3.7)

solvent: water

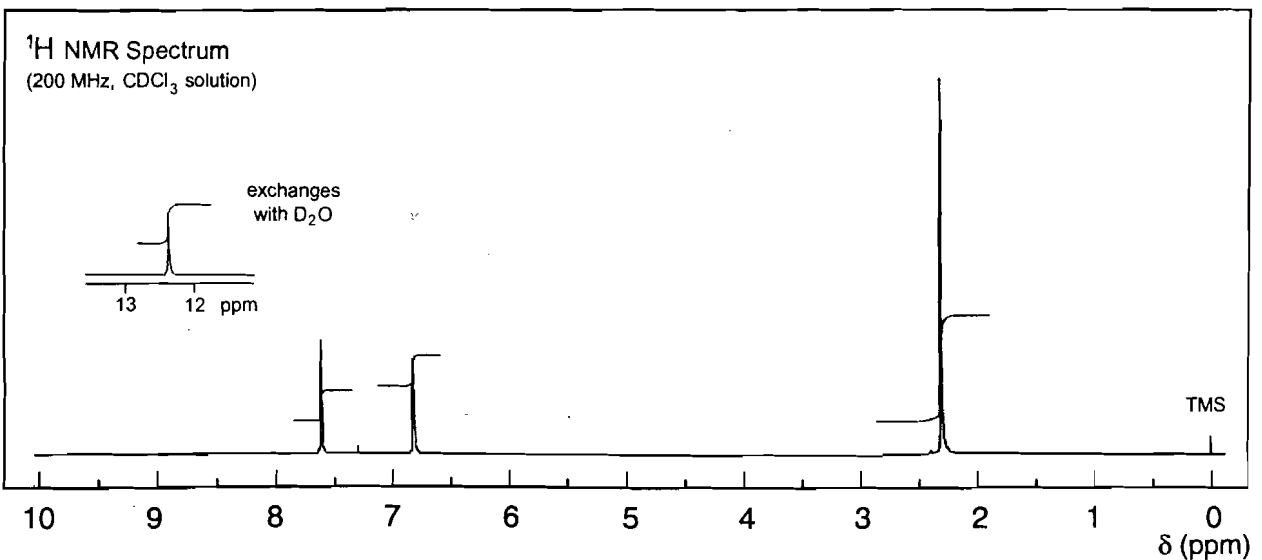
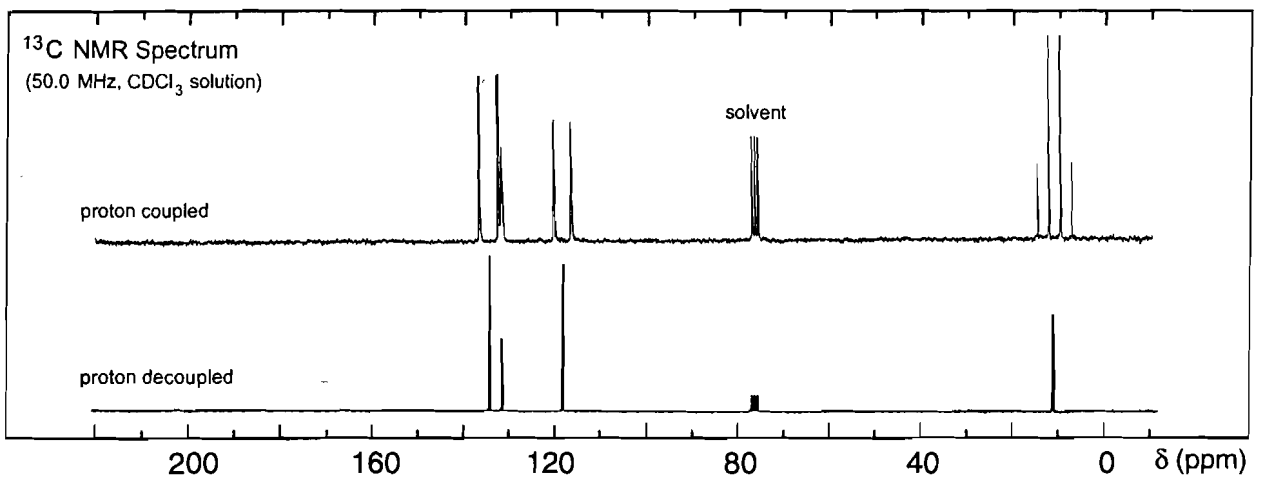



# Problem 239

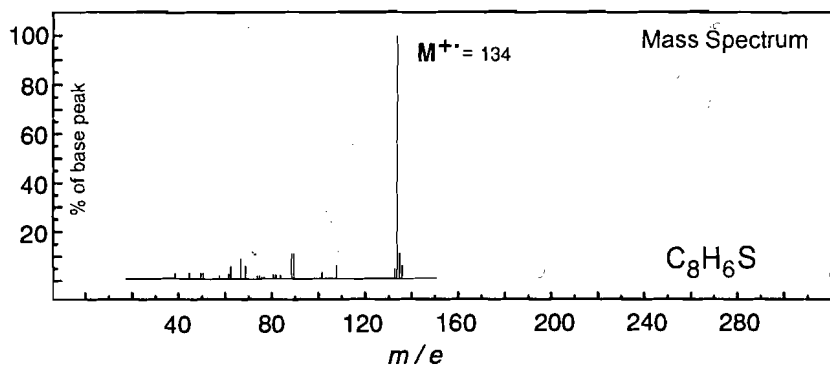
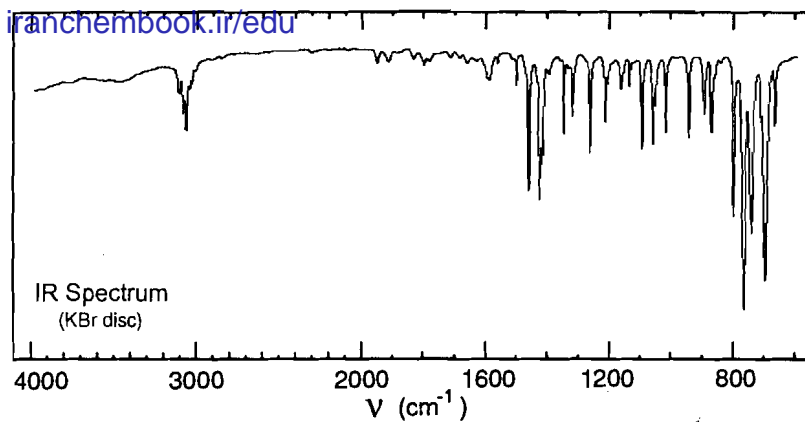

UV Spectrum

$\lambda_{\text{max}}$  226 nm ( $\log_{10} \epsilon$  4.4)

$\lambda_{\text{max}}$  256 nm ( $\log_{10} \epsilon$  3.7)

$\lambda_{\text{max}}$  288 nm ( $\log_{10} \epsilon$  3.3)

$\lambda_{\text{max}}$  297 nm ( $\log_{10} \epsilon$  3.5)

solvent: ethanol

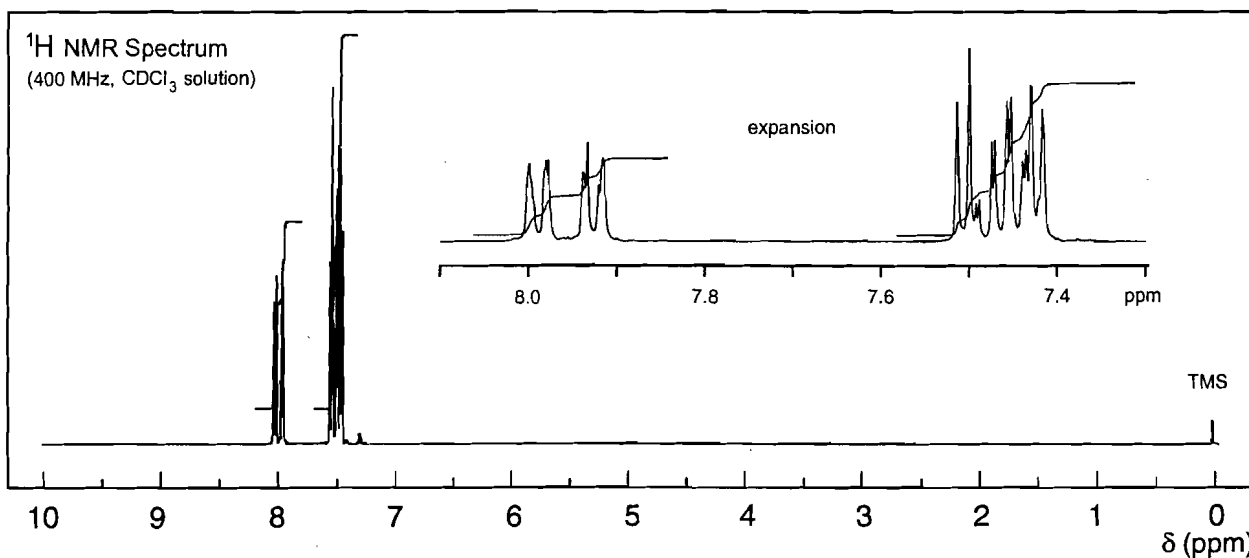
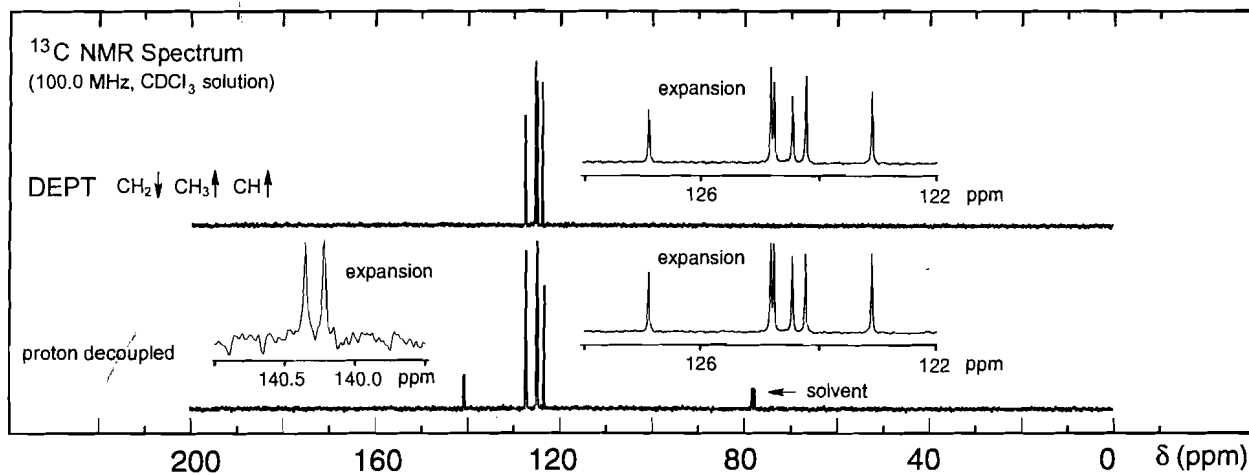

## Problem 240

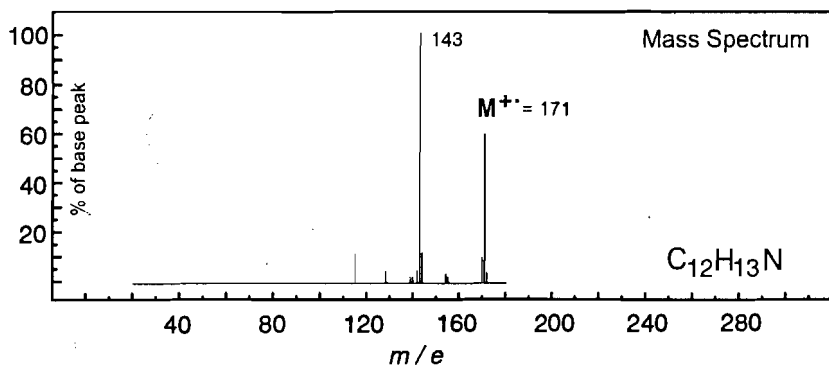
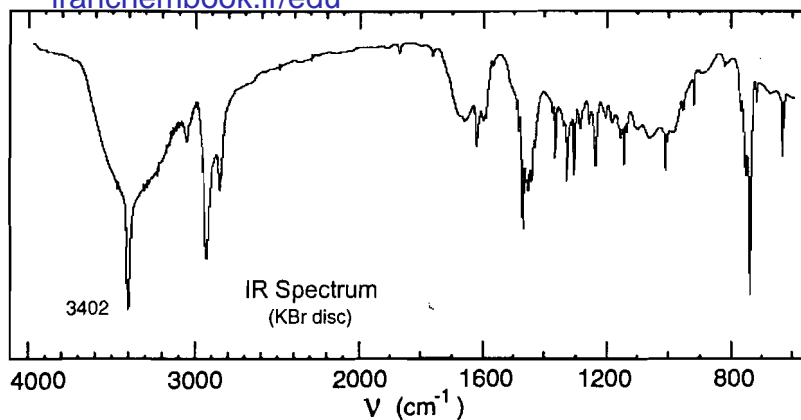

UV Spectrum

 $\lambda_{\text{max}}$  229 nm ( $\log_{10} \epsilon$  4.4) $\lambda_{\text{max}}$  284 nm ( $\log_{10} \epsilon$  3.8)

solvent: ethanol

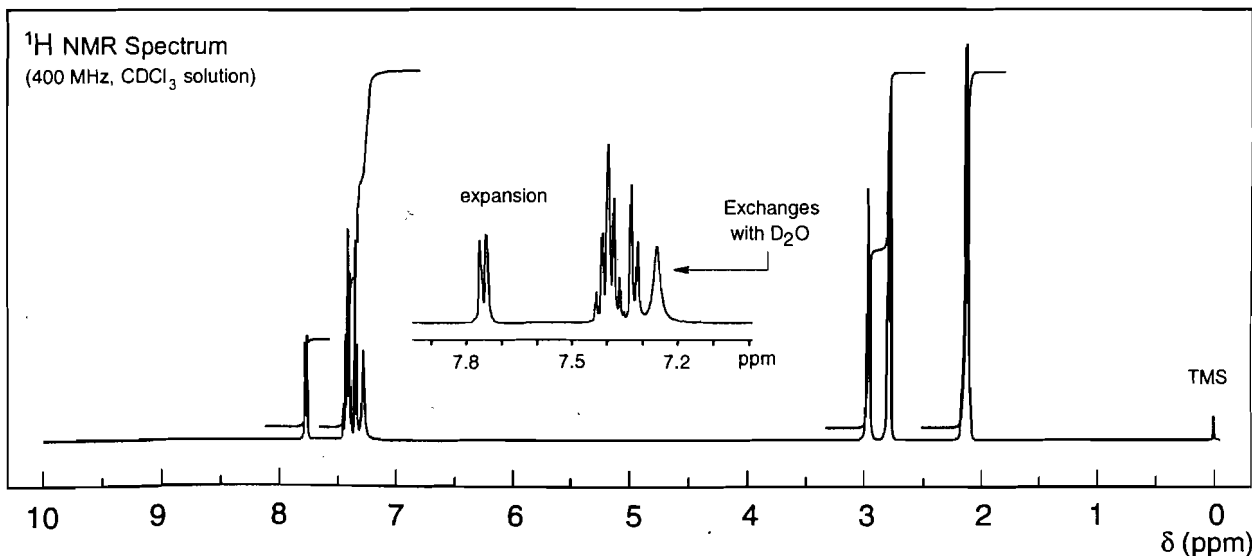
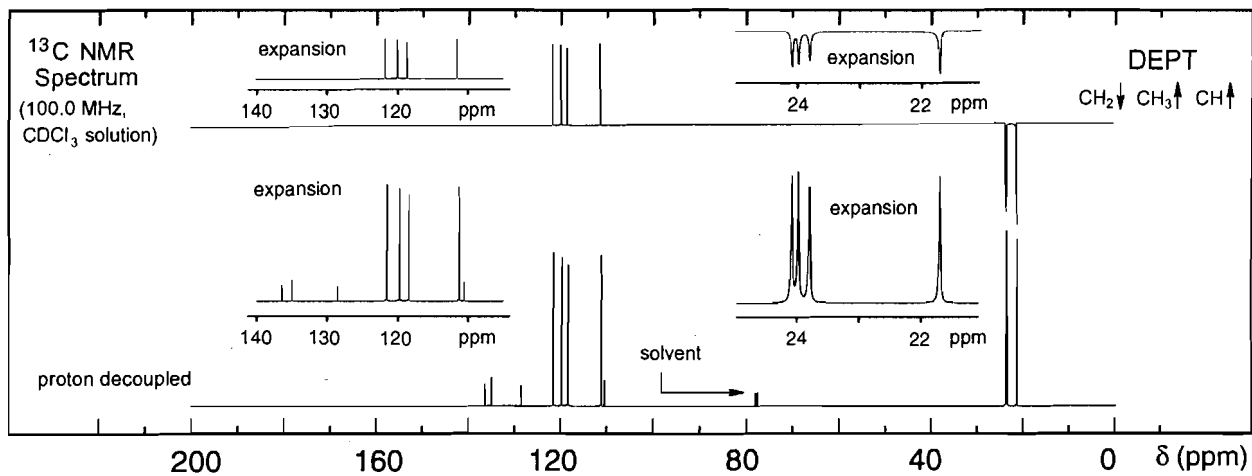

## Problem 241

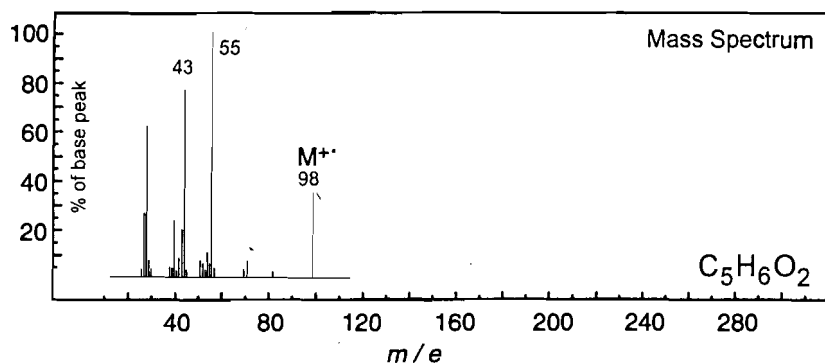
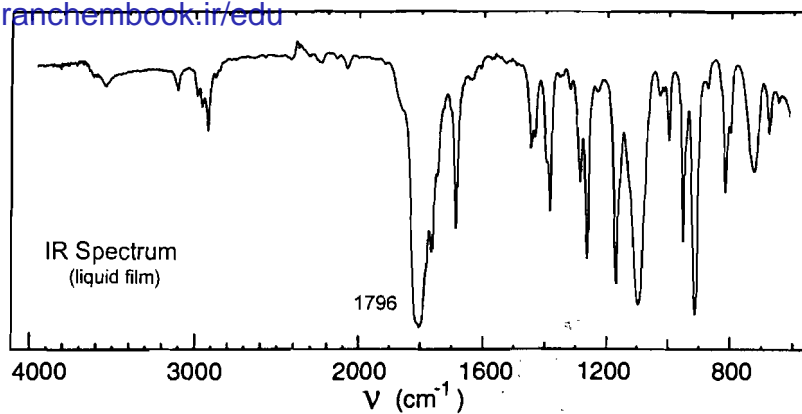

UV Spectrum

 $\lambda_{\text{max}}$  217 nm ( $\log_{10} \epsilon$  3.4)

solvent: ethanol

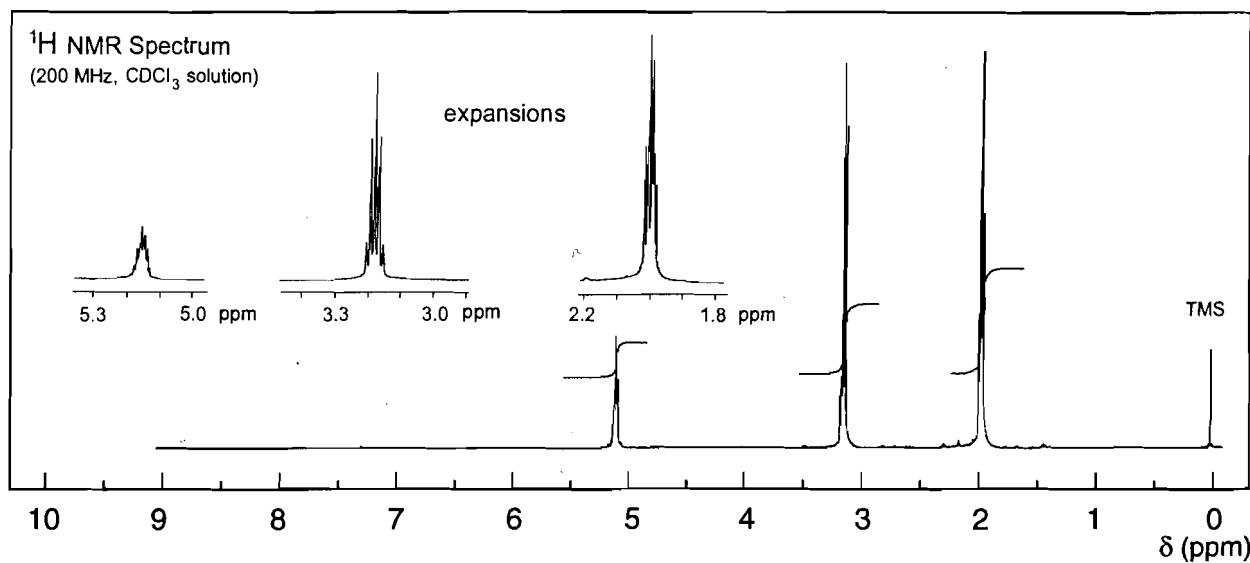
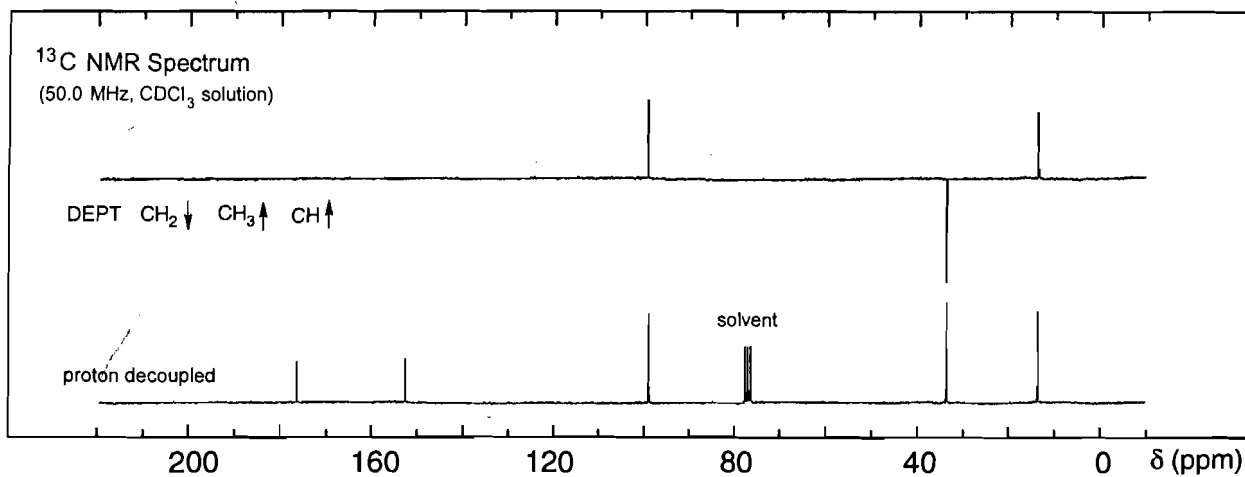

# Problem 242

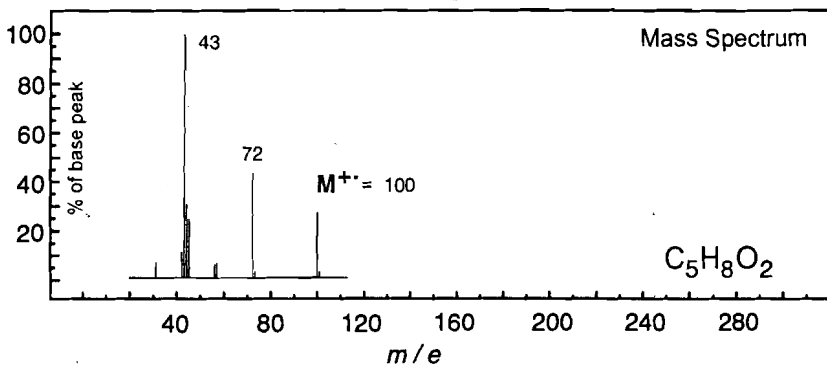
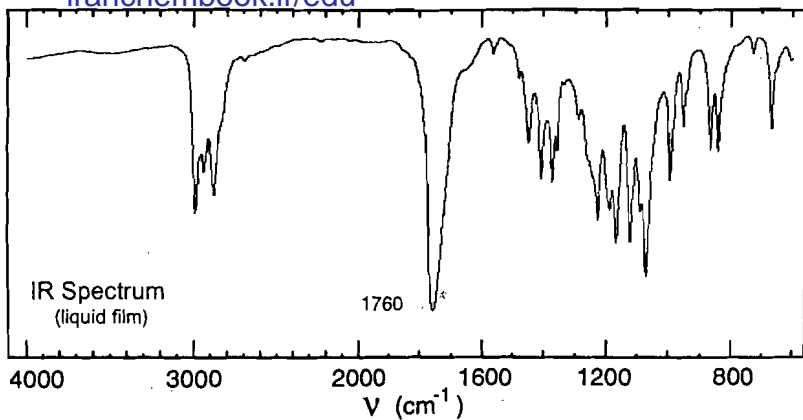

No significant UV absorption above 220 nm

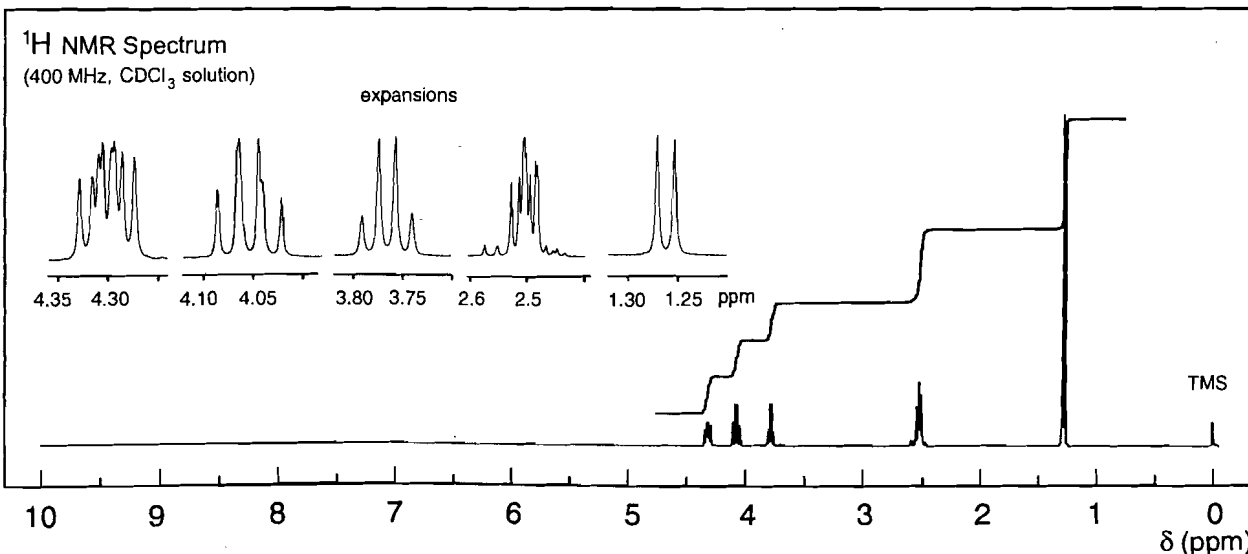
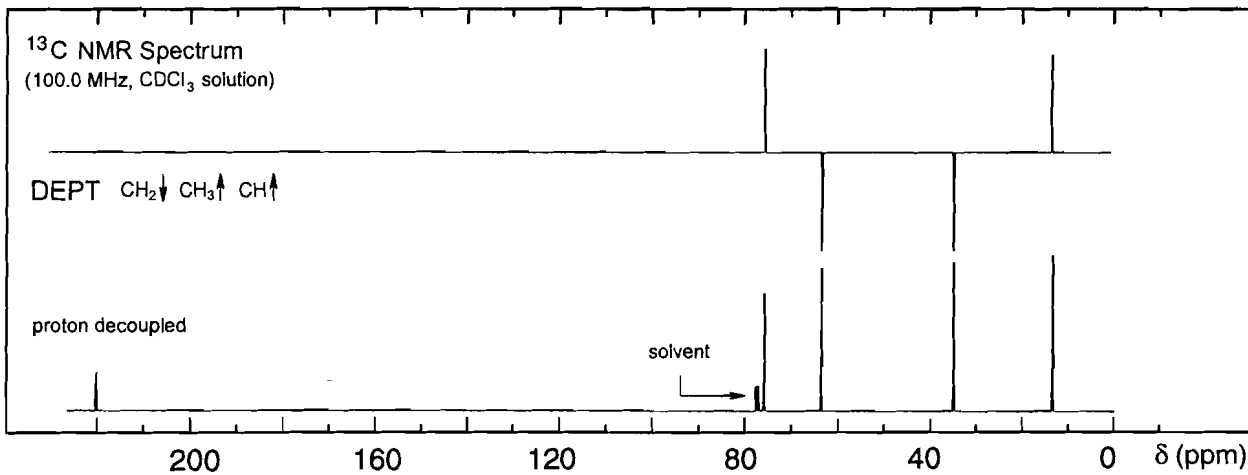

## Problem 243

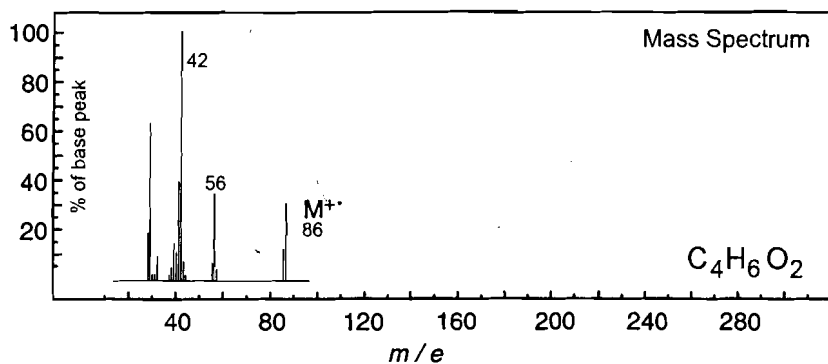
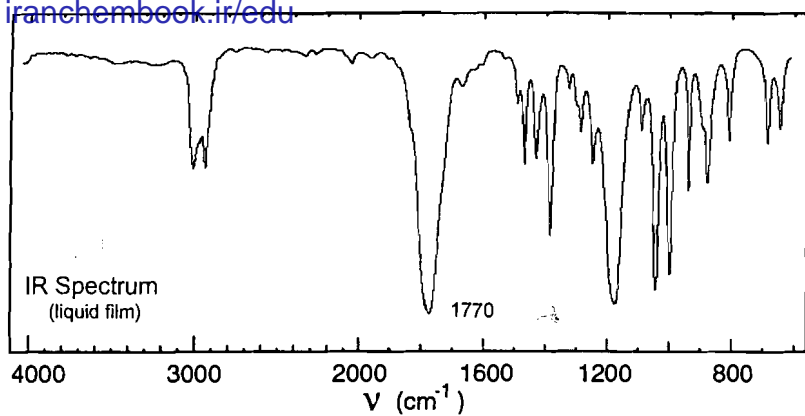

No significant UV  
absorption above 220 nm

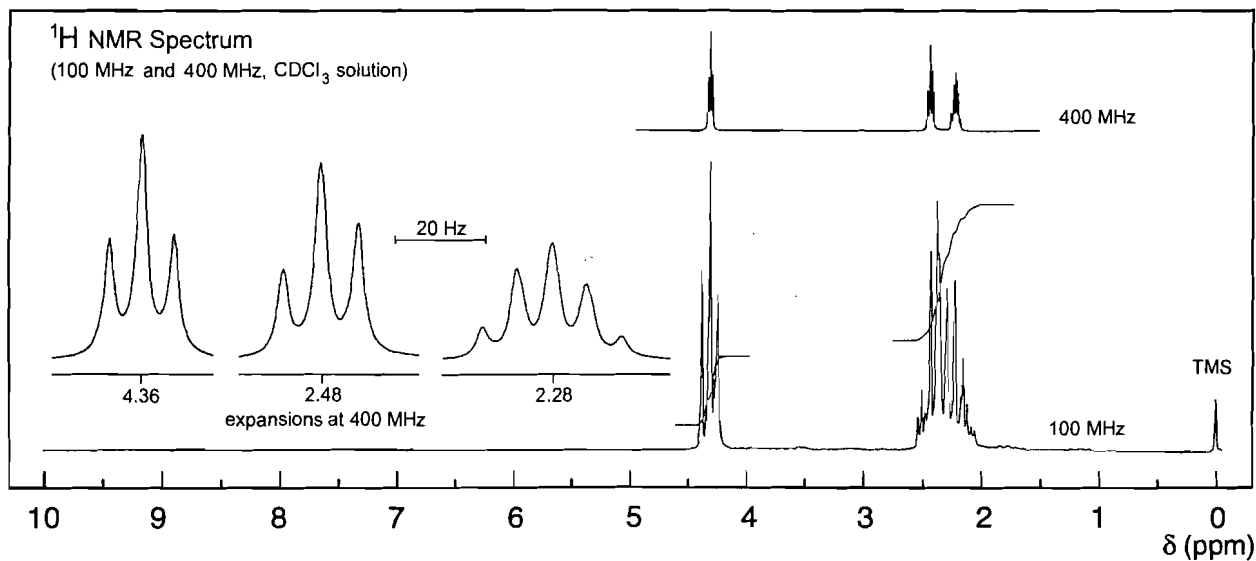
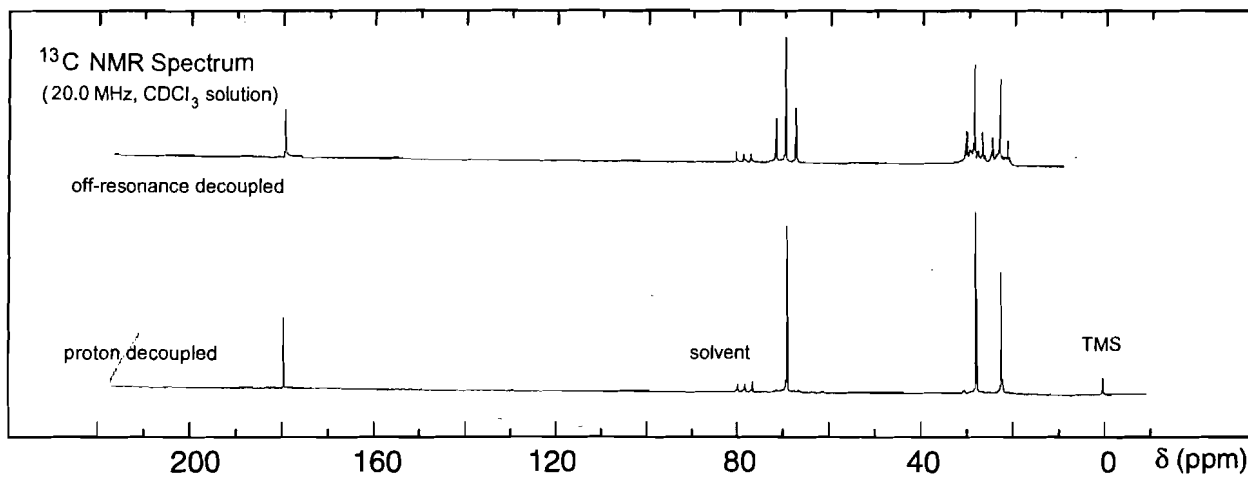

# Problem 244

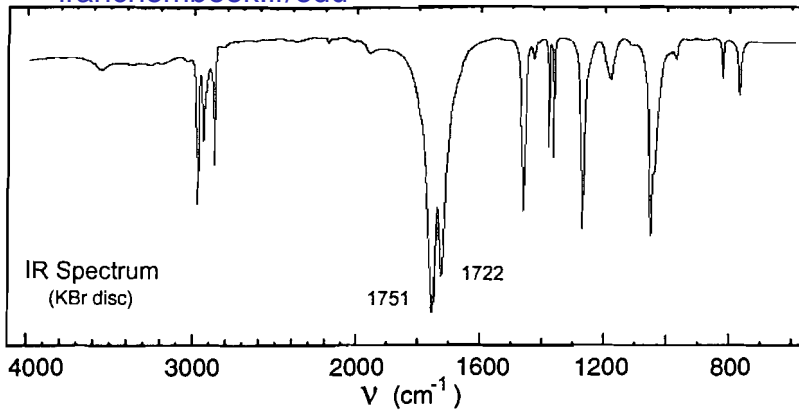

Note: this compound has no significant dipole moment

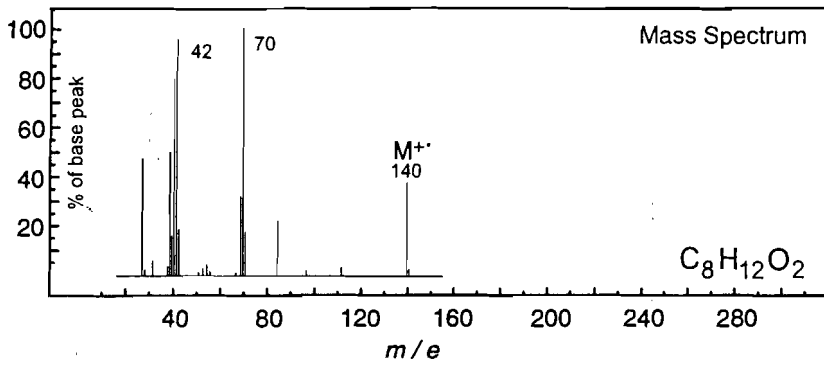

No significant UV absorption above 220 nm

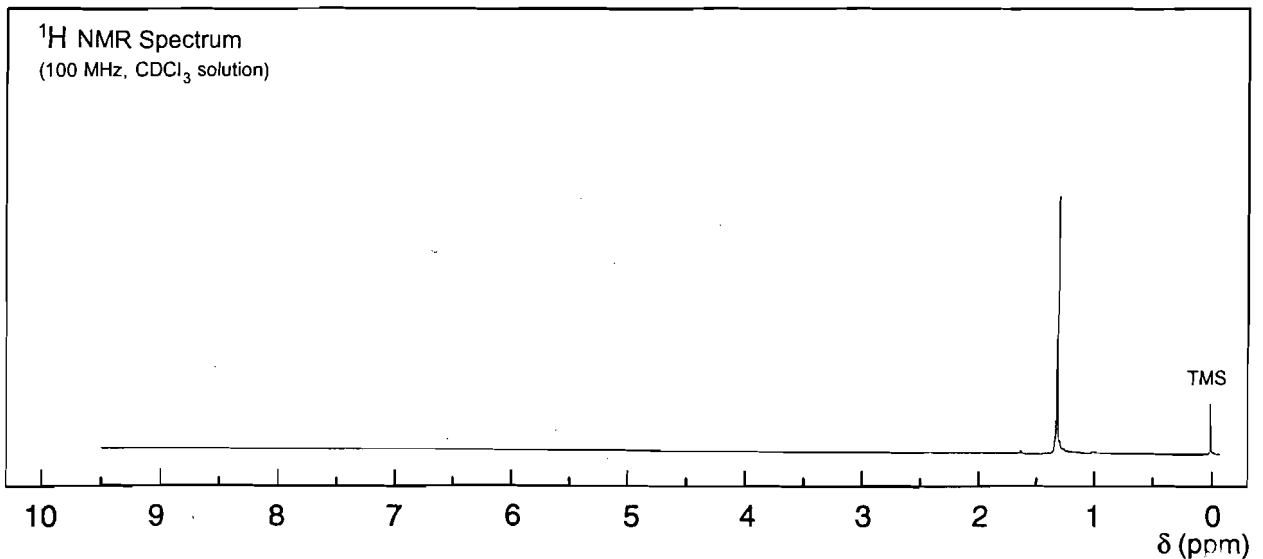
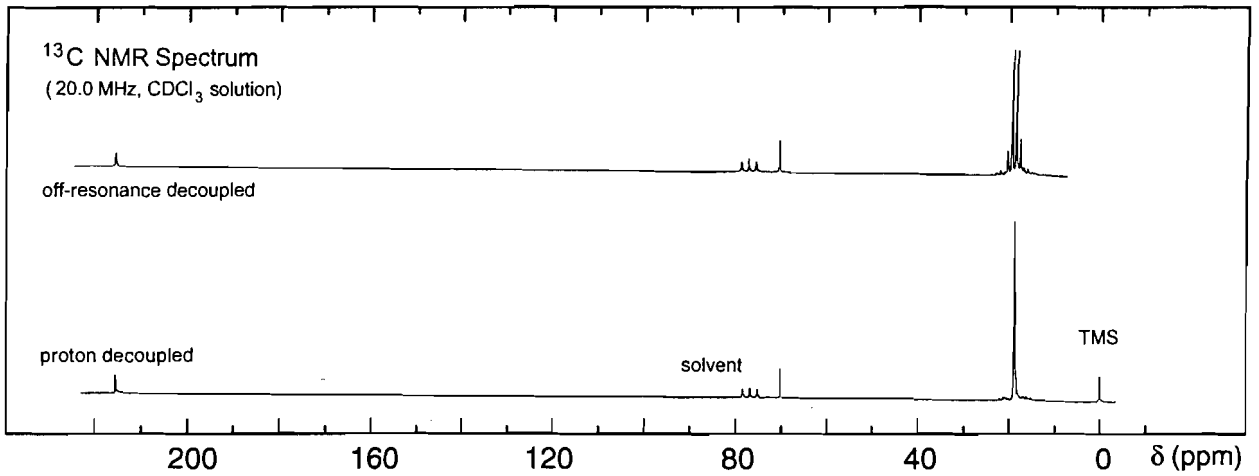

## Problem 245

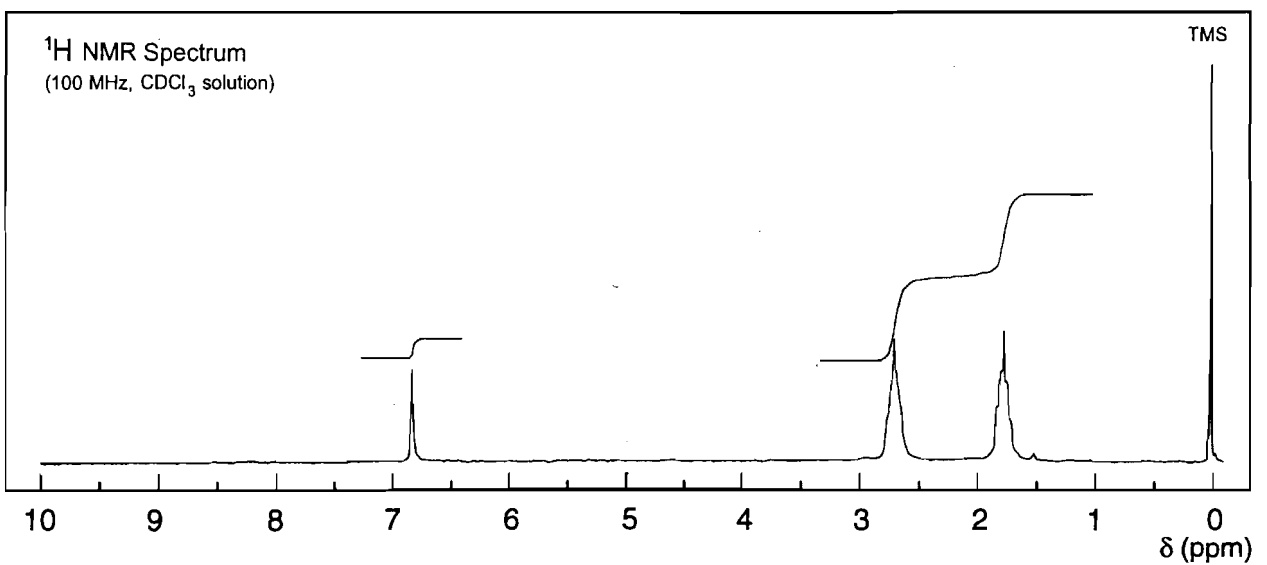
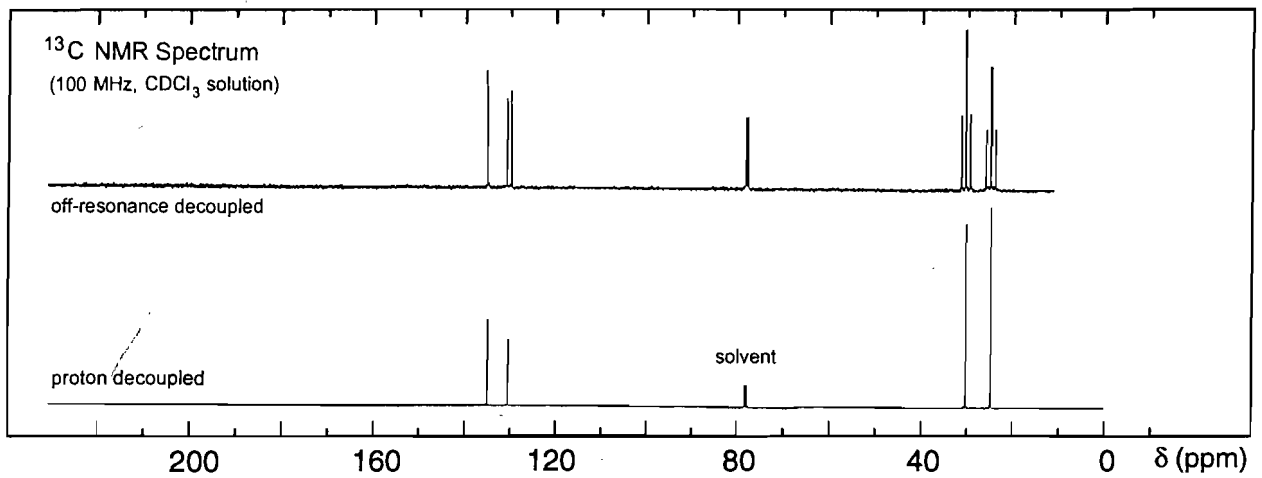
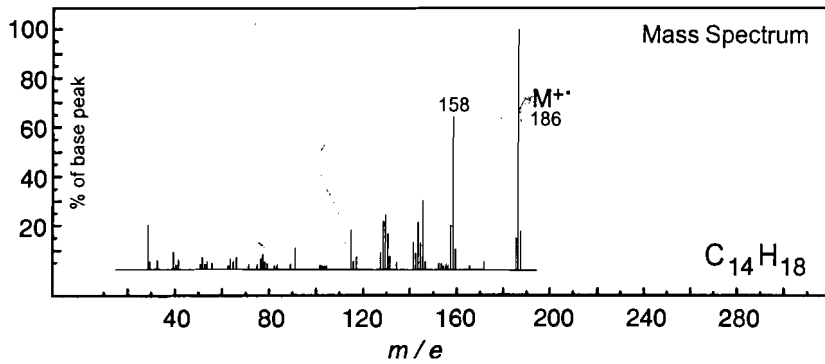
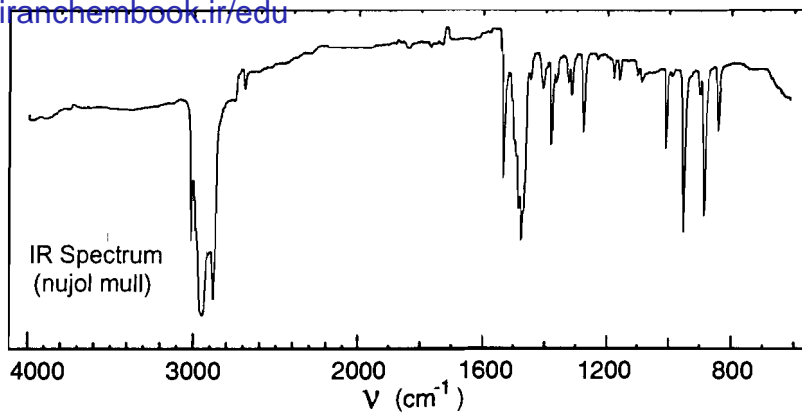

## Problem 246

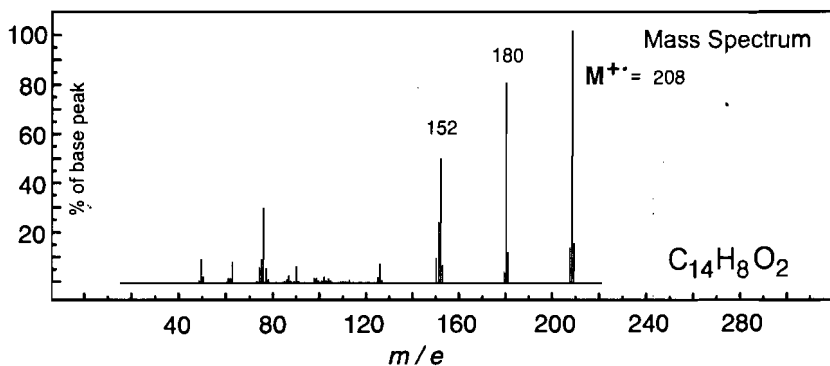
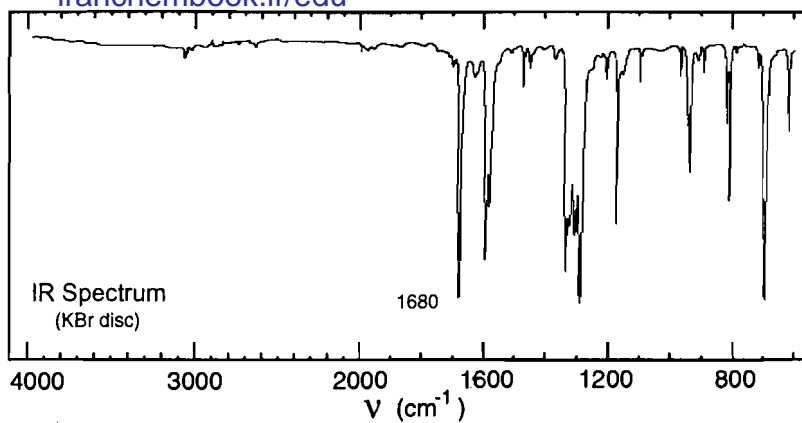

UV Spectrum

 $\lambda_{\text{max}}$  255 nm ( $\log_{10} \epsilon$  4.7) $\lambda_{\text{max}}$  275 nm ( $\log_{10} \epsilon$  4.3) $\lambda_{\text{max}}$  330 nm ( $\log_{10} \epsilon$  3.8)

solvent: ethanol

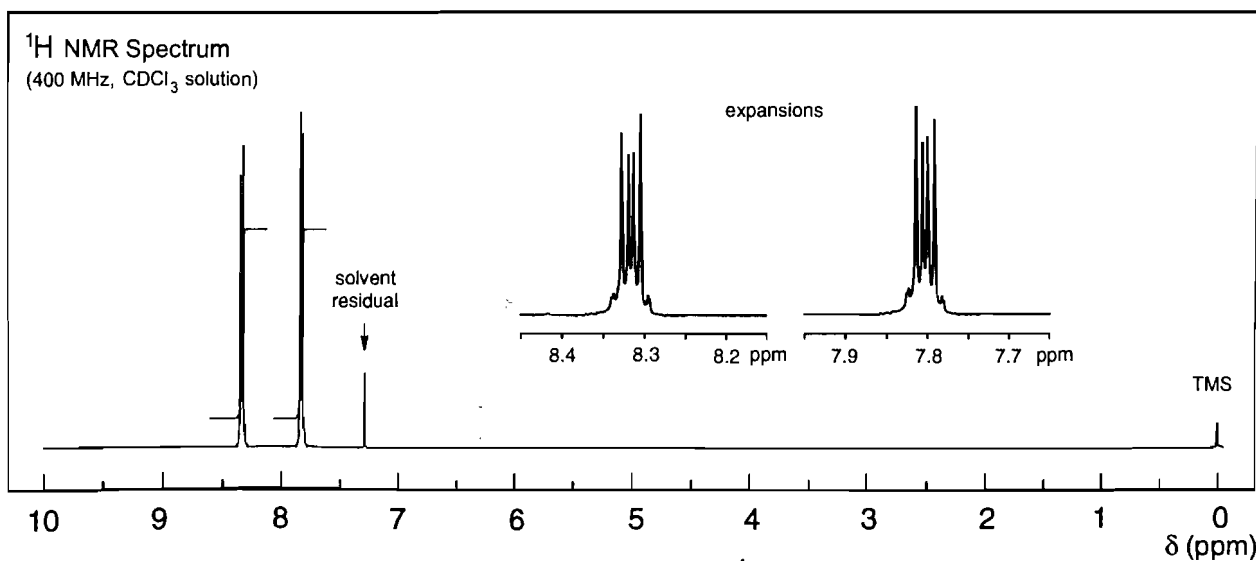
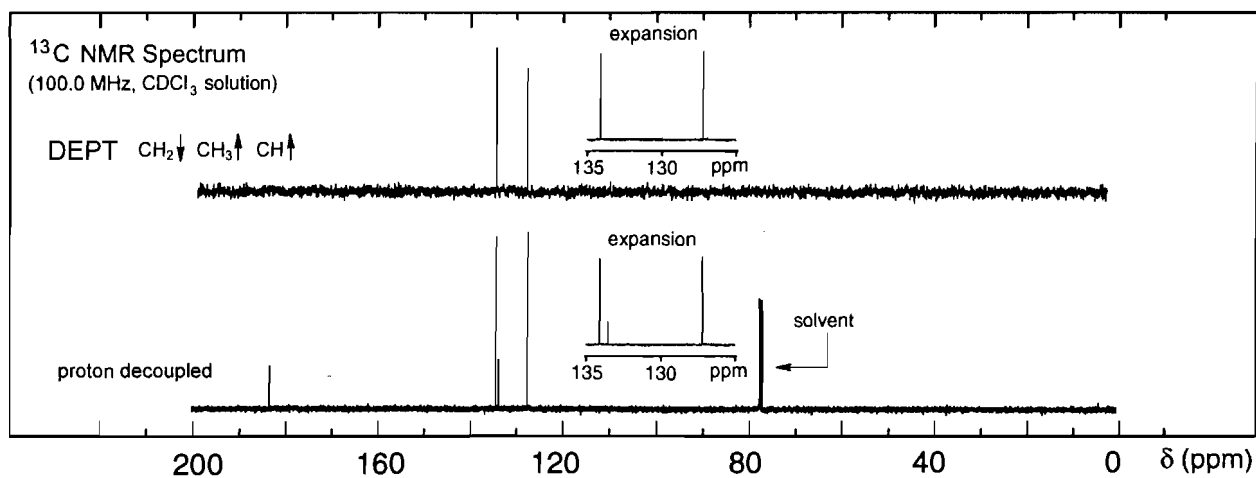



## Problem 247

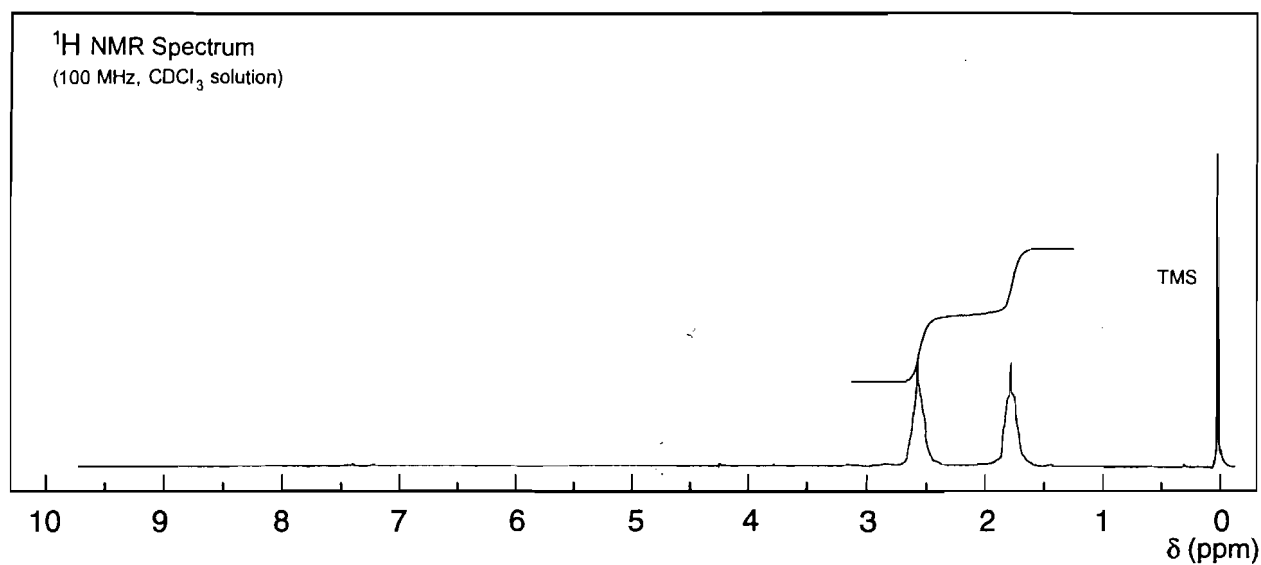
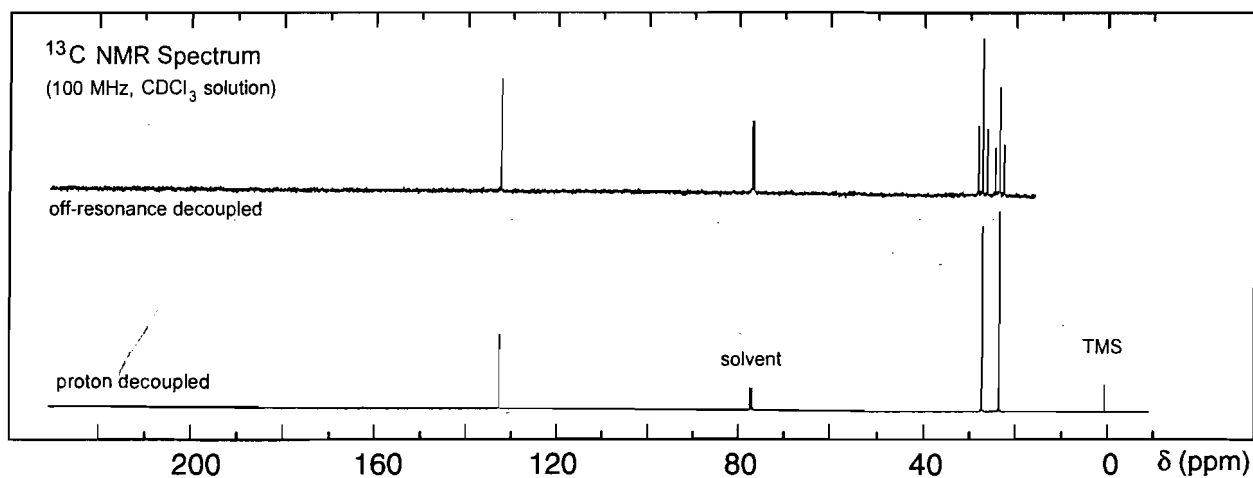
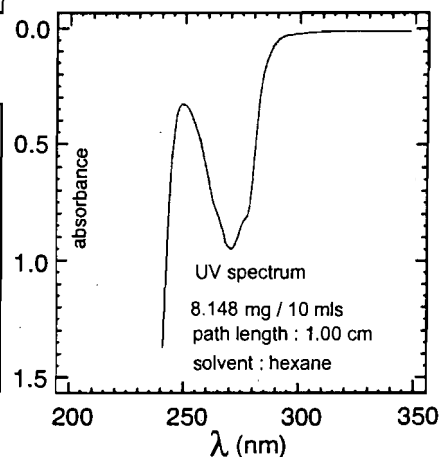
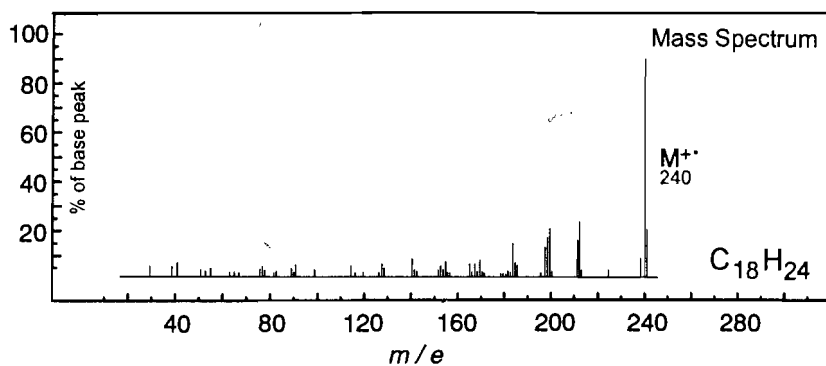
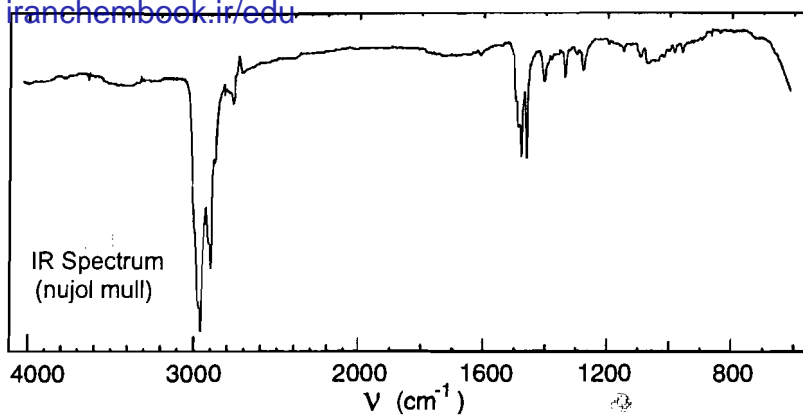

## Problem 248

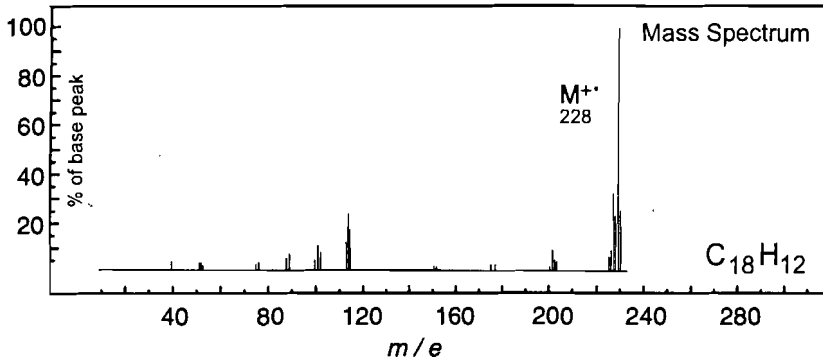
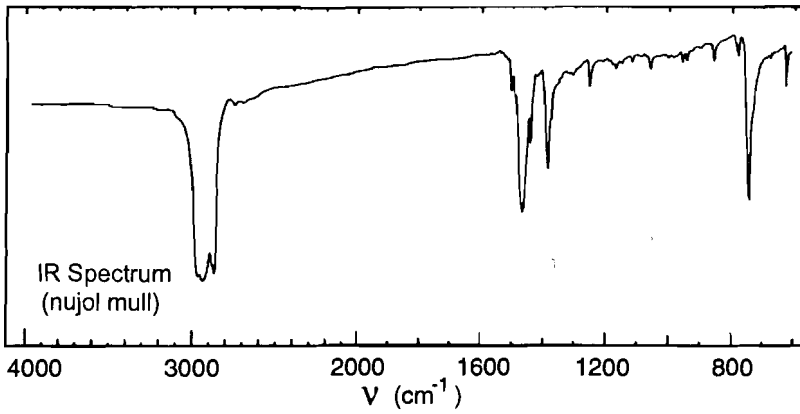

## UV Spectrum

 $\lambda_{\max}$  249 nm ( $\log_{10} \epsilon$  5.0)

 $\lambda_{\max}$  257 nm ( $\log_{10} \epsilon$  5.2)

 $\lambda_{\max}$  273 nm ( $\log_{10} \epsilon$  4.4)

solvent : ethanol

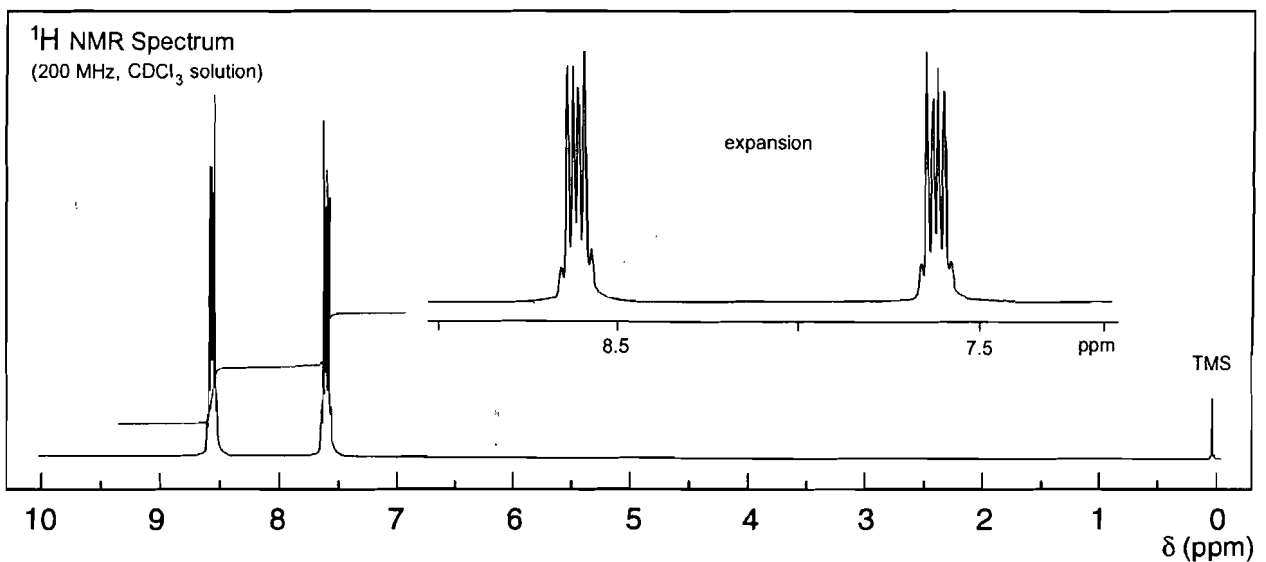
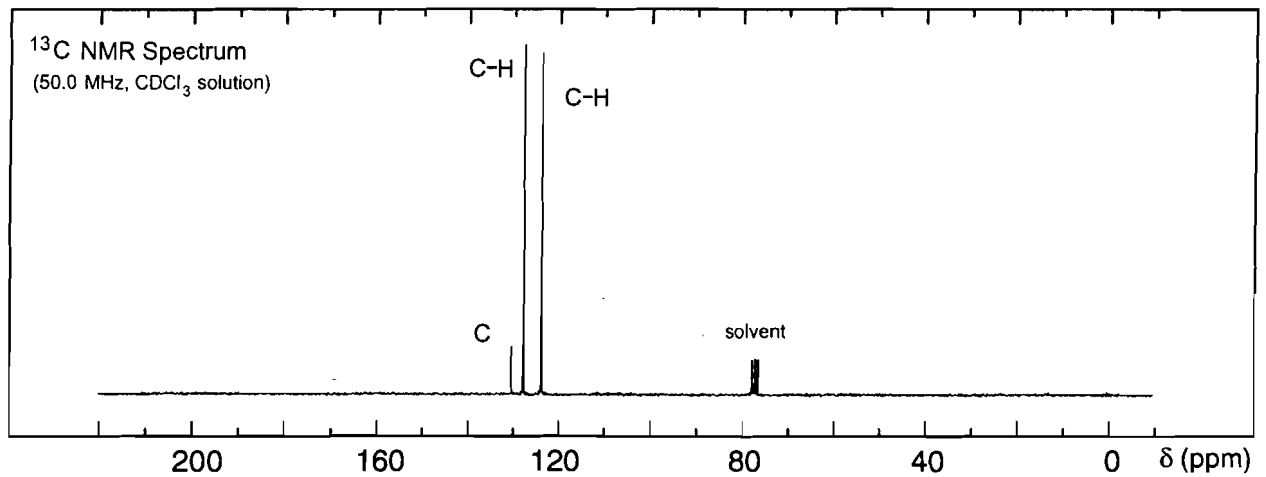

## Problem 249

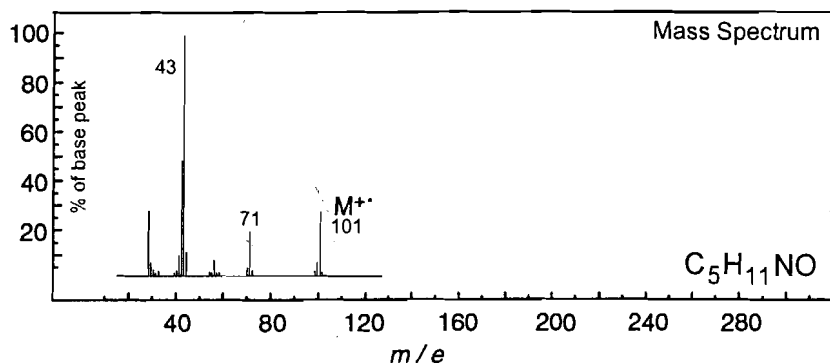
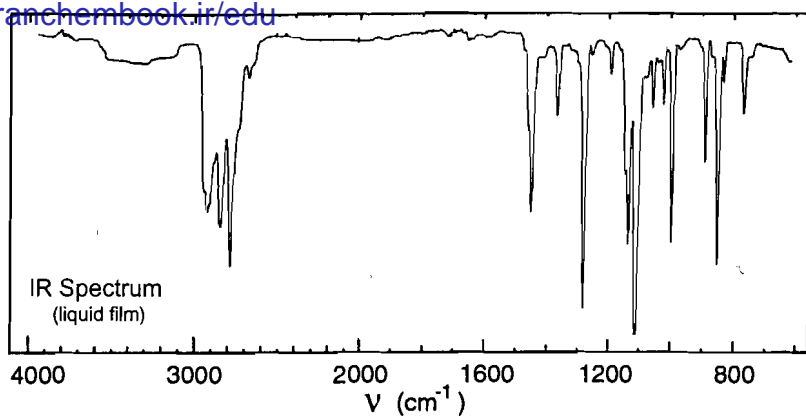

No significant UV  
absorption above 220 nm

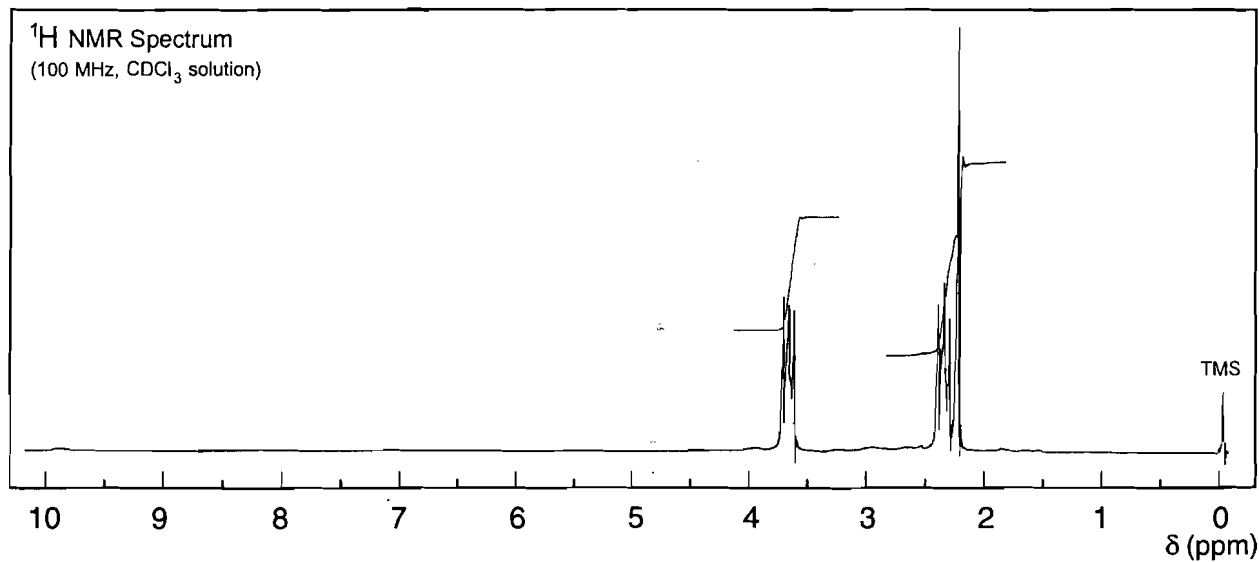
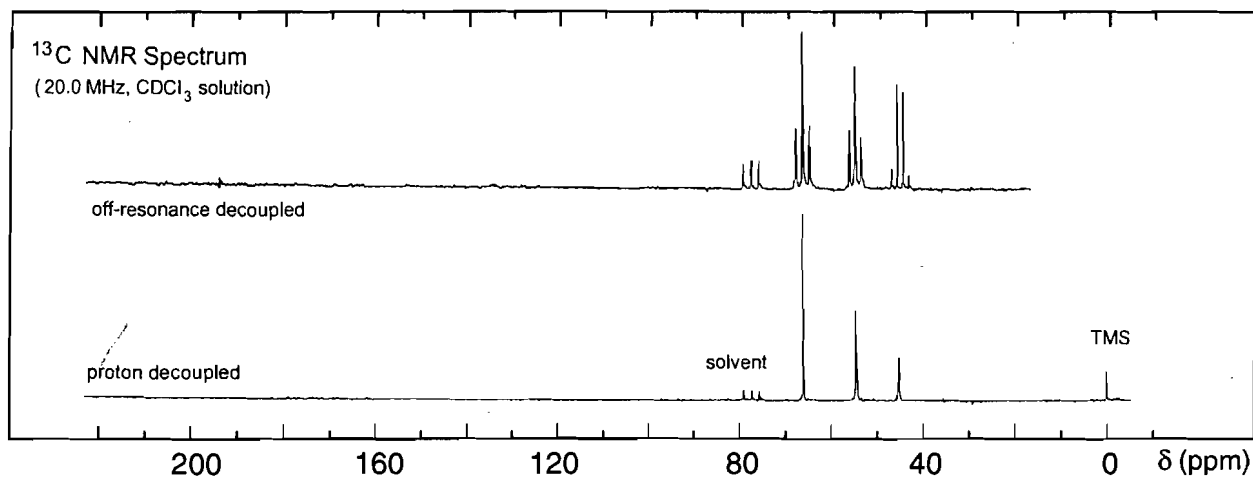

## Problem 250

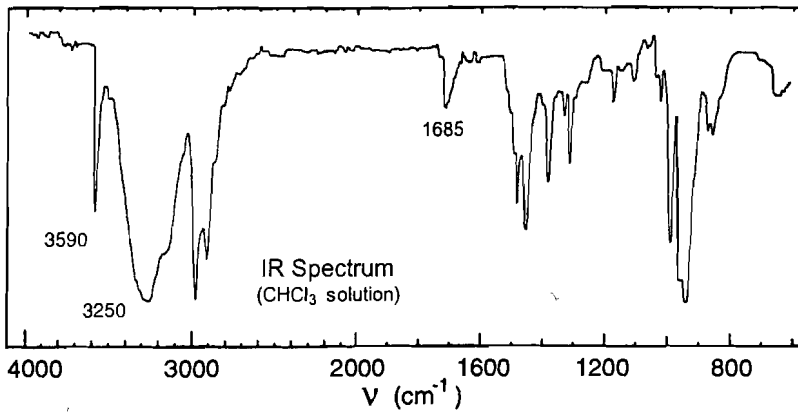

No significant UV  
absorption above 220 nm

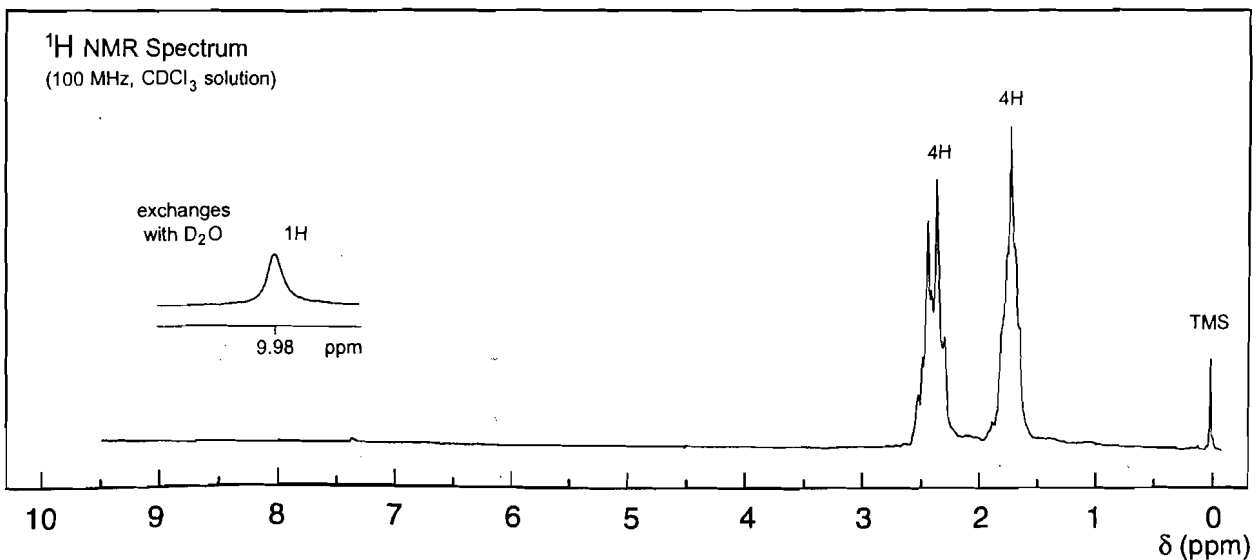
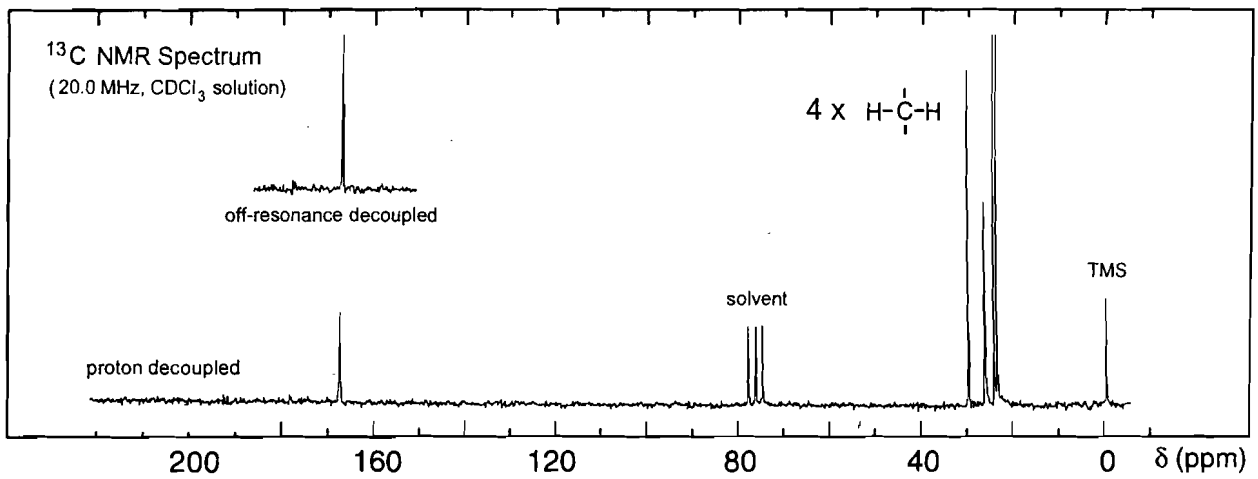
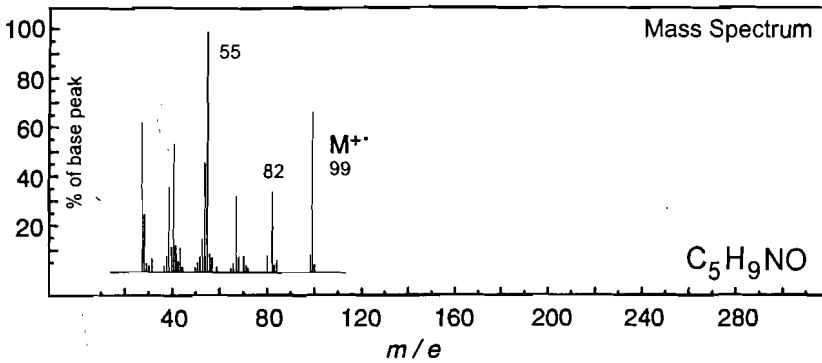

## Problem 251

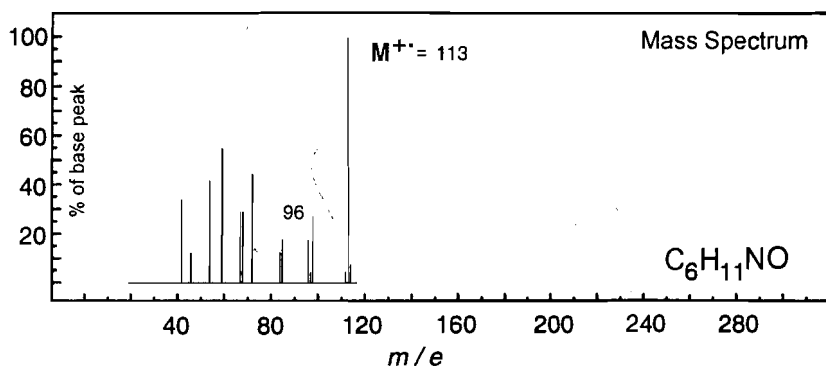
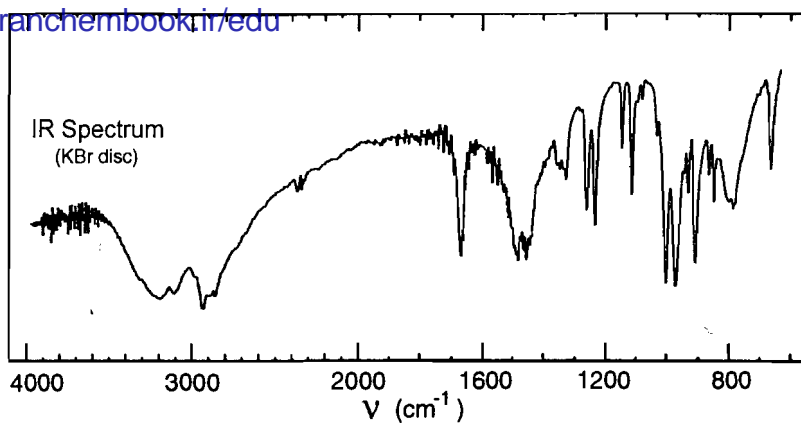

UV Spectrum

 $\lambda_{\text{max}}$  310 nm ( $\log_{10} \epsilon$  1.2)

solvent: isooctane

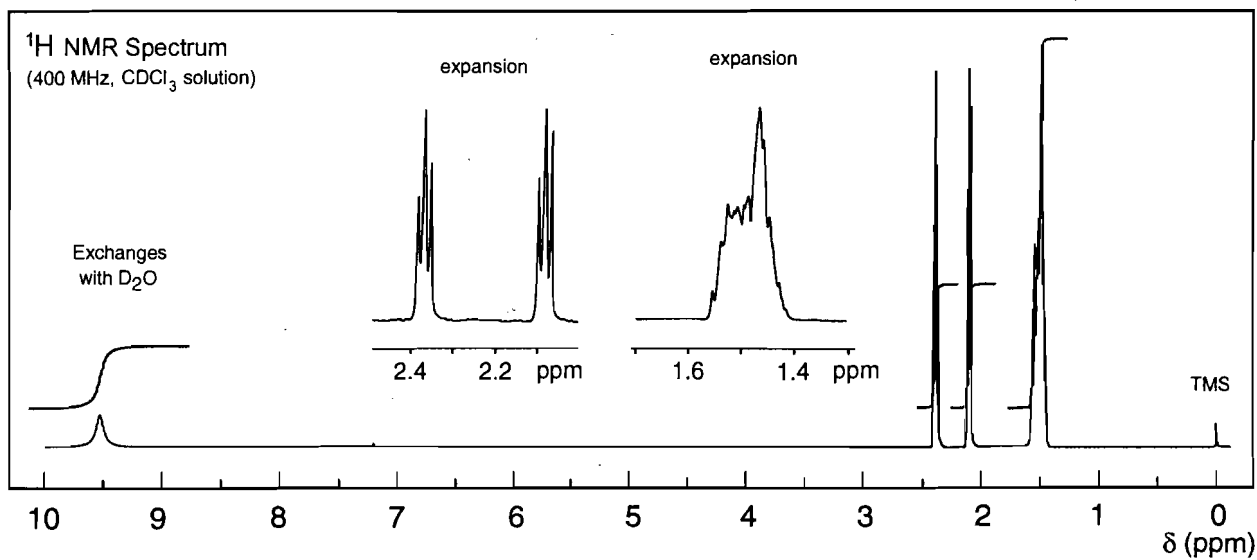
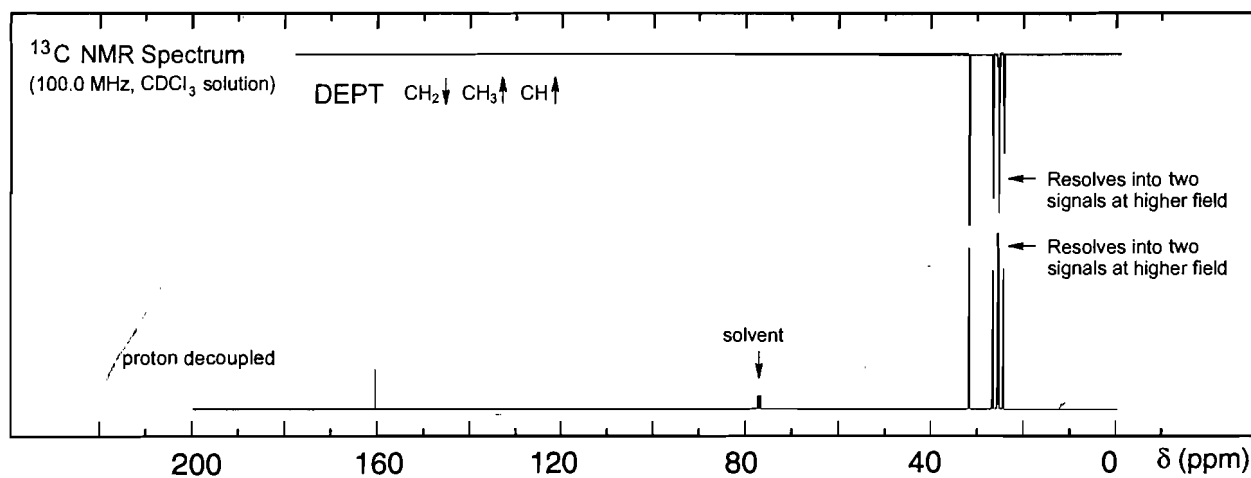

# Problem 252

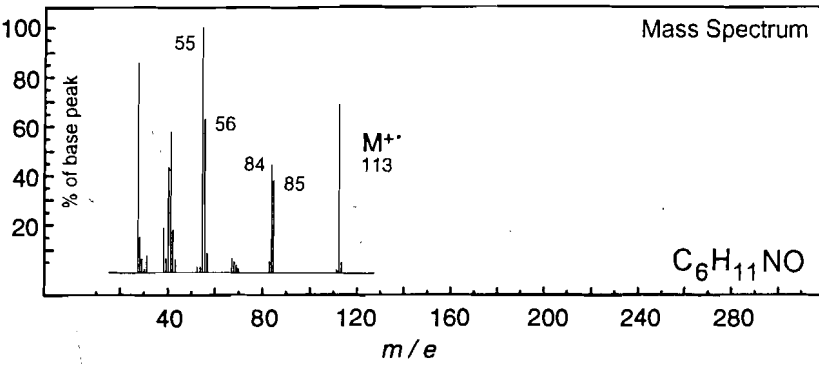
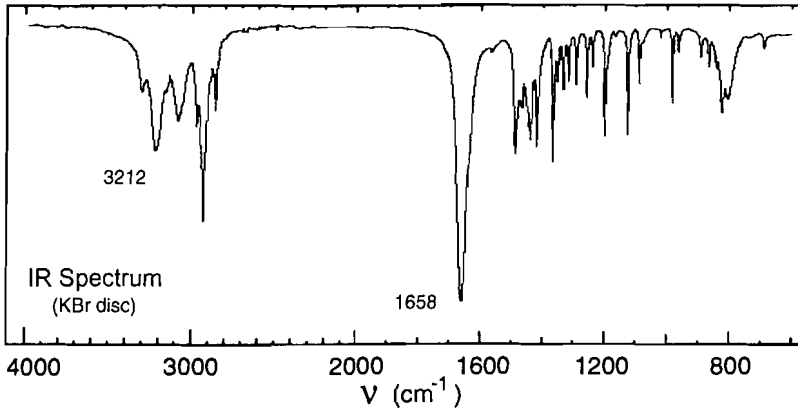

No significant UV absorption above 220 nm

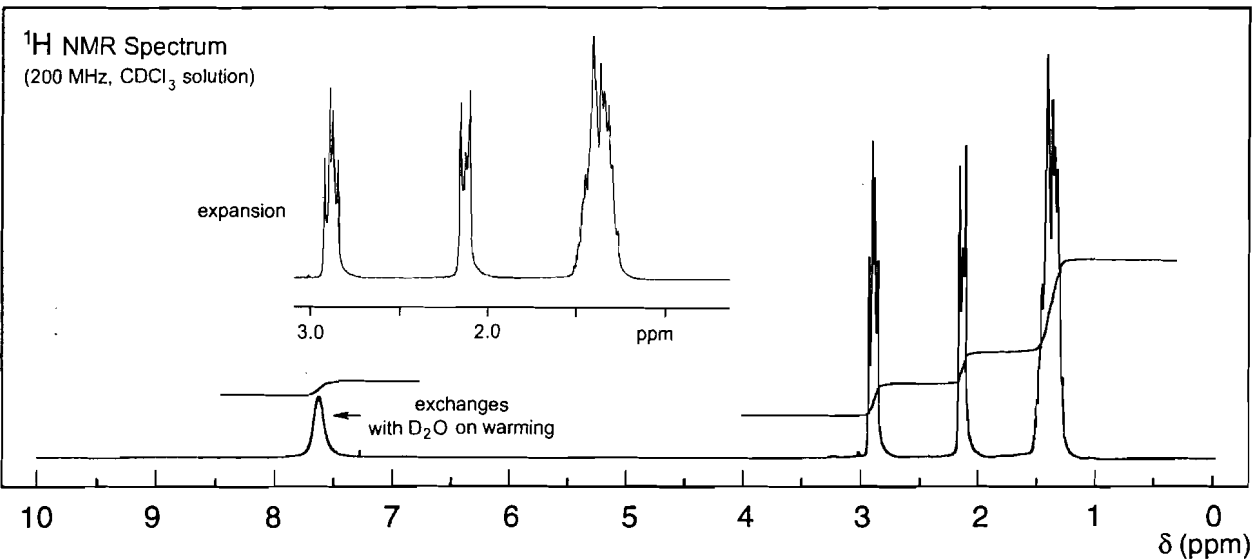
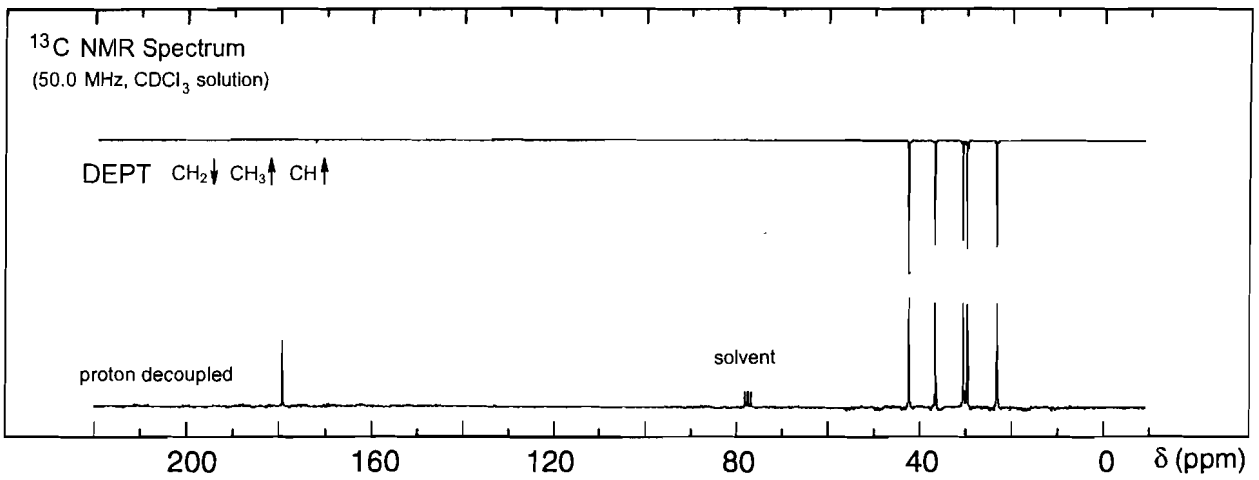

## Problem 253

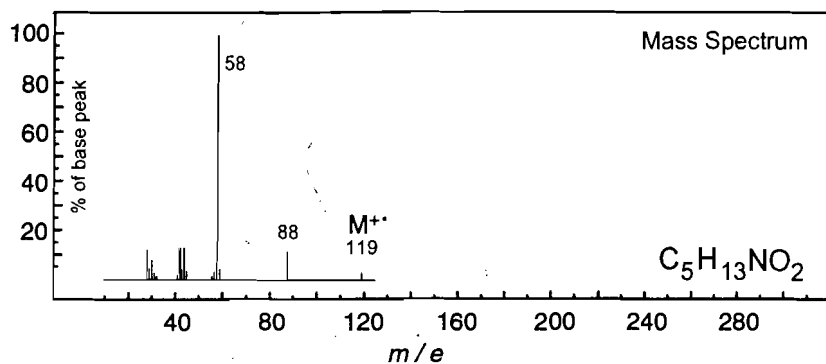
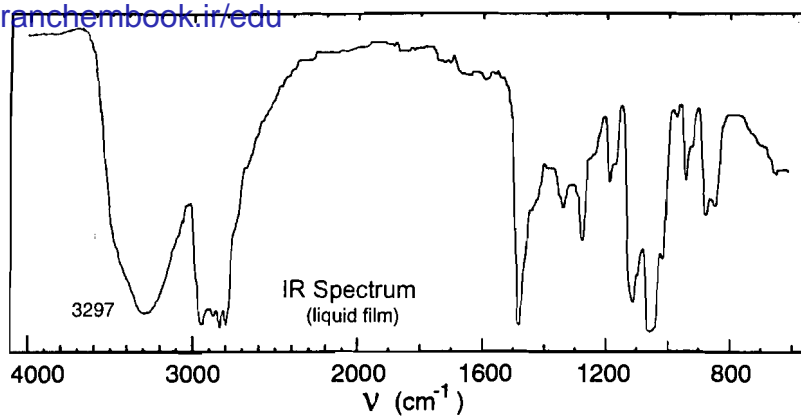

No significant UV  
absorption above 220 nm

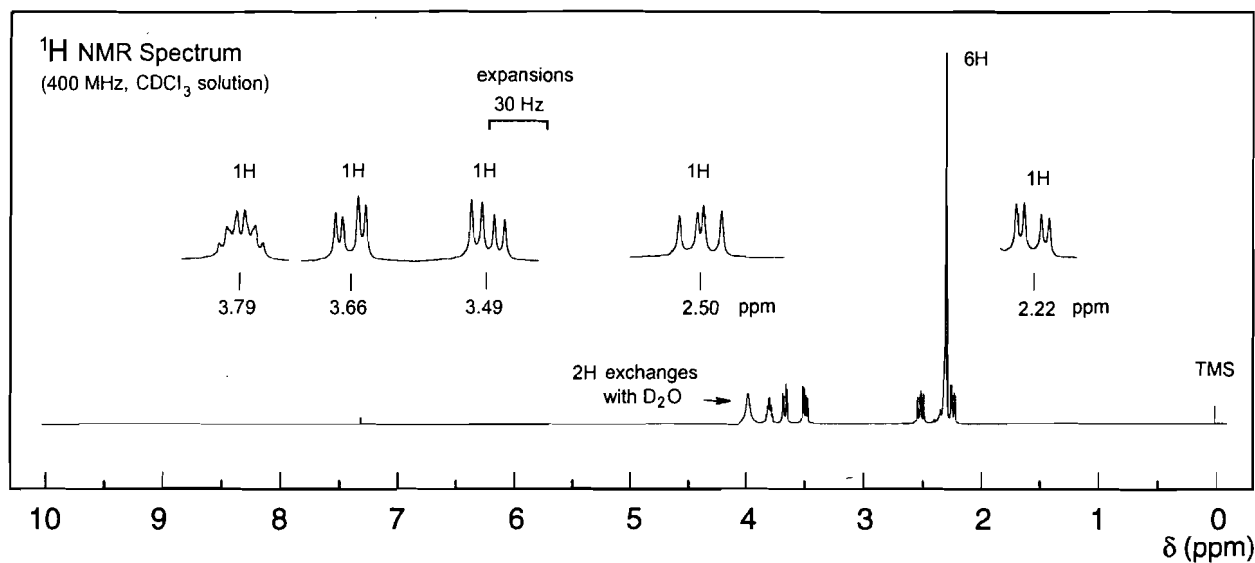
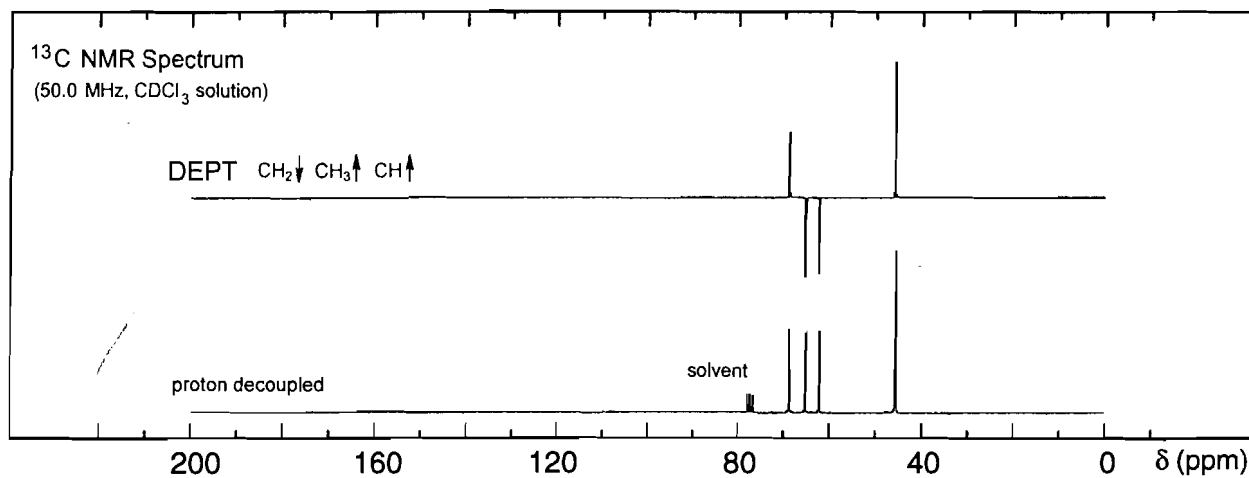

## Problem 254

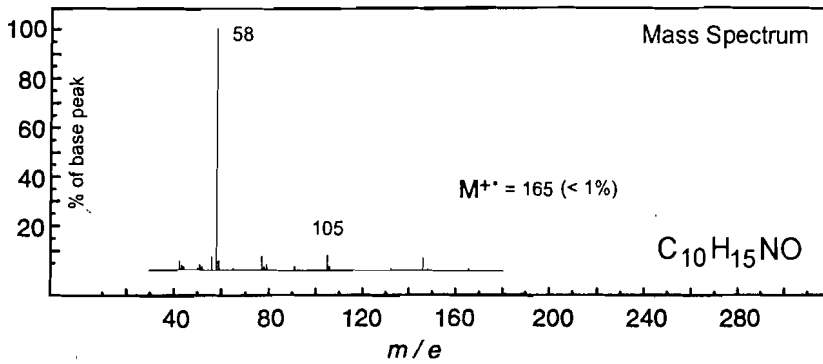
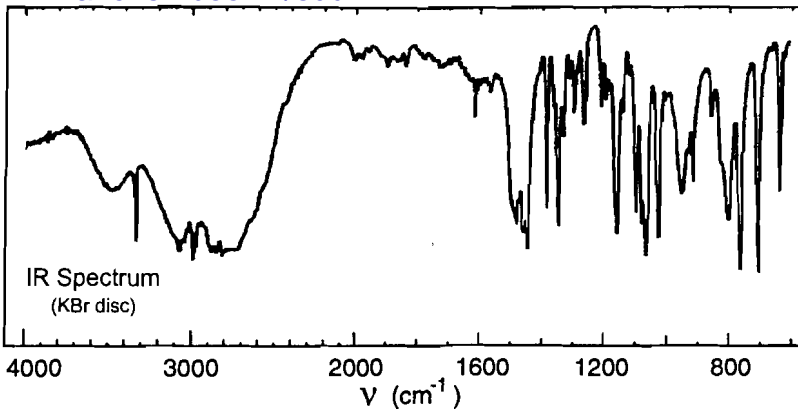

UV Spectrum

 $\lambda_{\max}$  258 nm ( $\log_{10} \epsilon$  2.3)

solvent : methanol

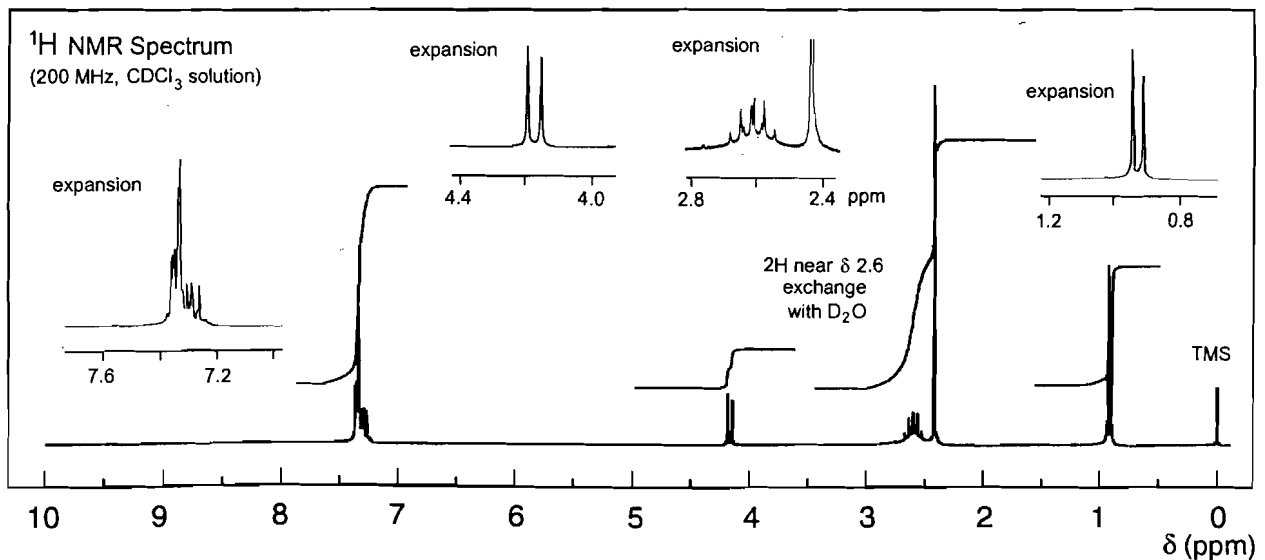
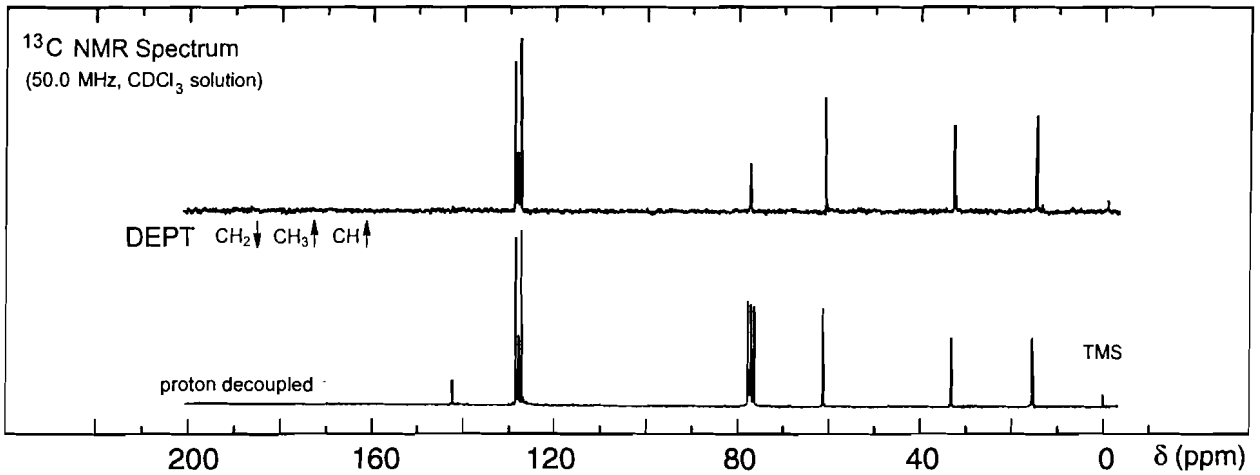



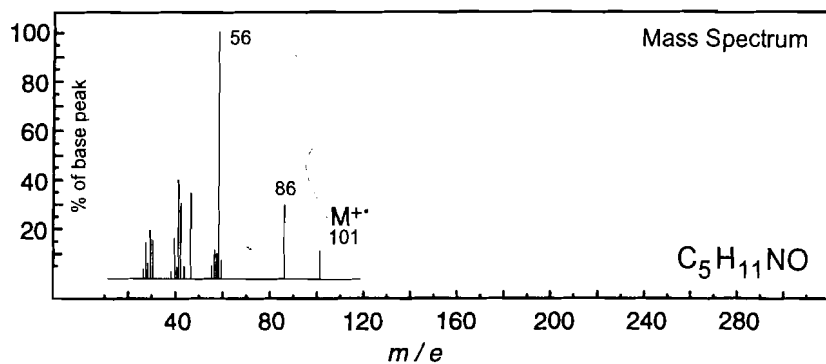
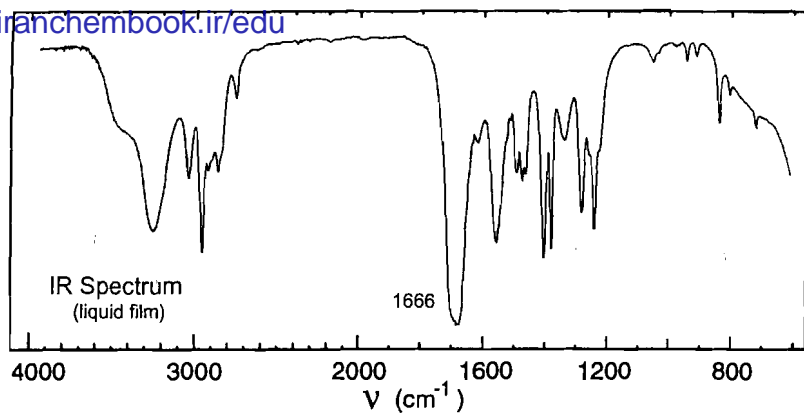

No significant UV  
absorption above 220 nm

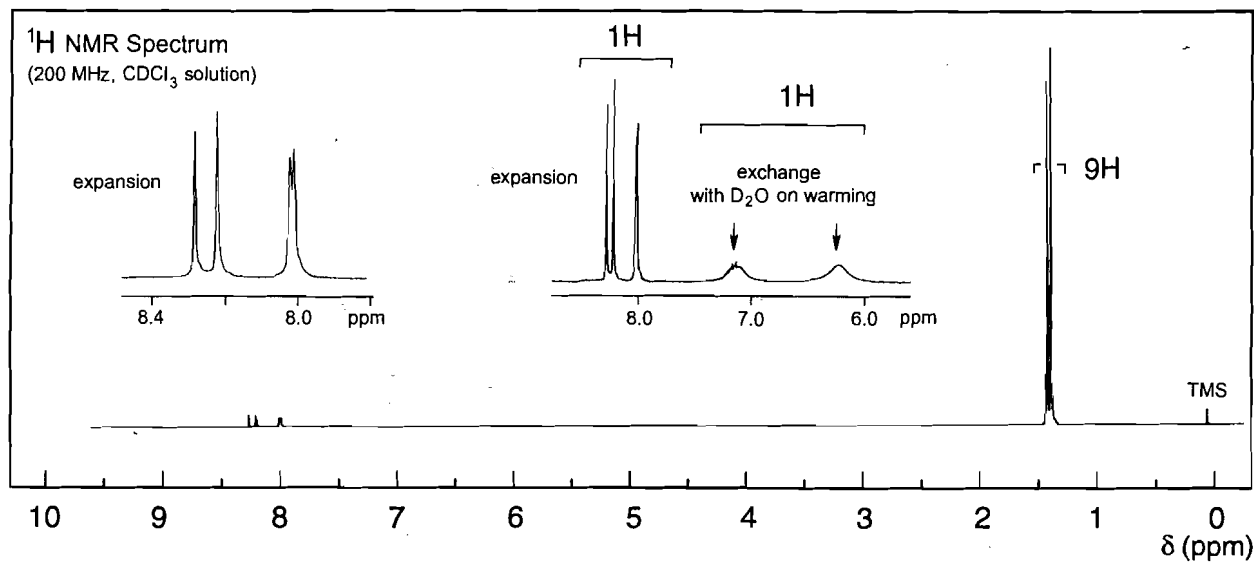
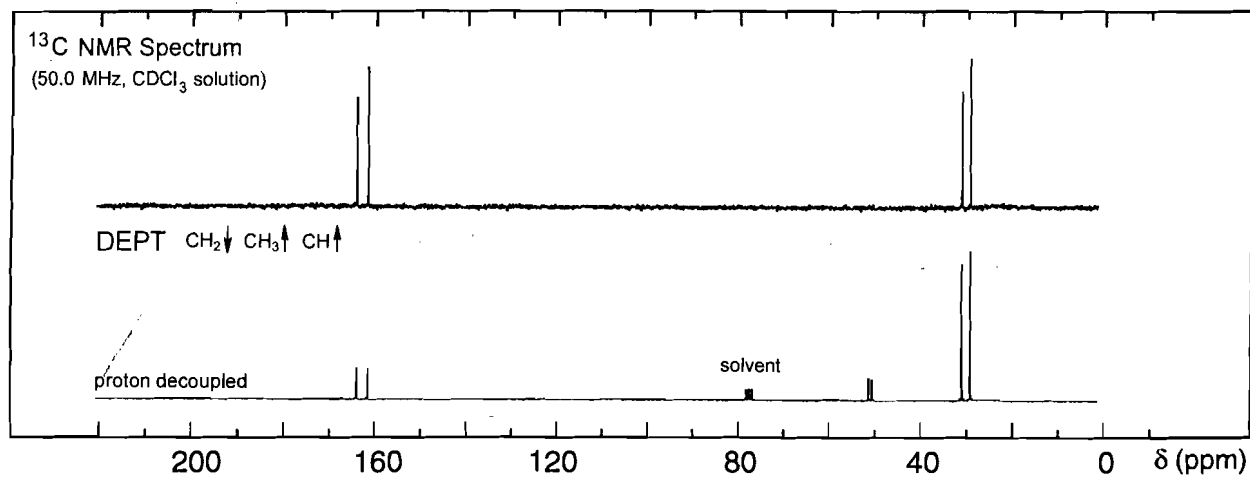

# Problem 256

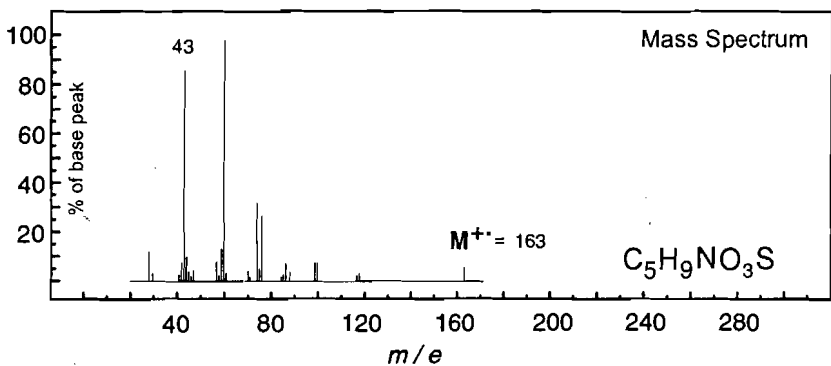
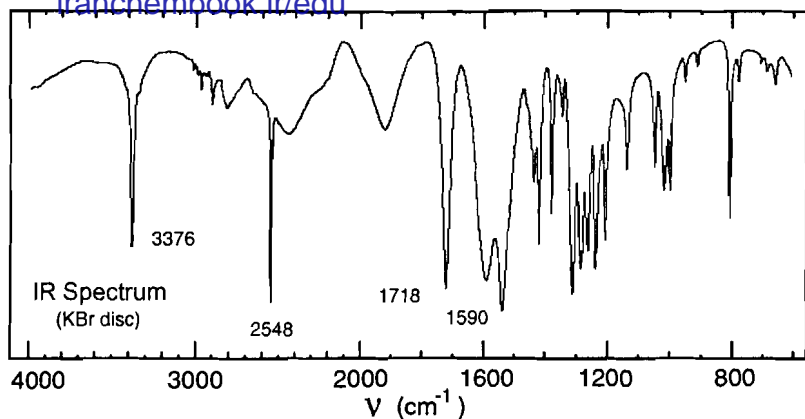

No significant UV absorption above 220 nm

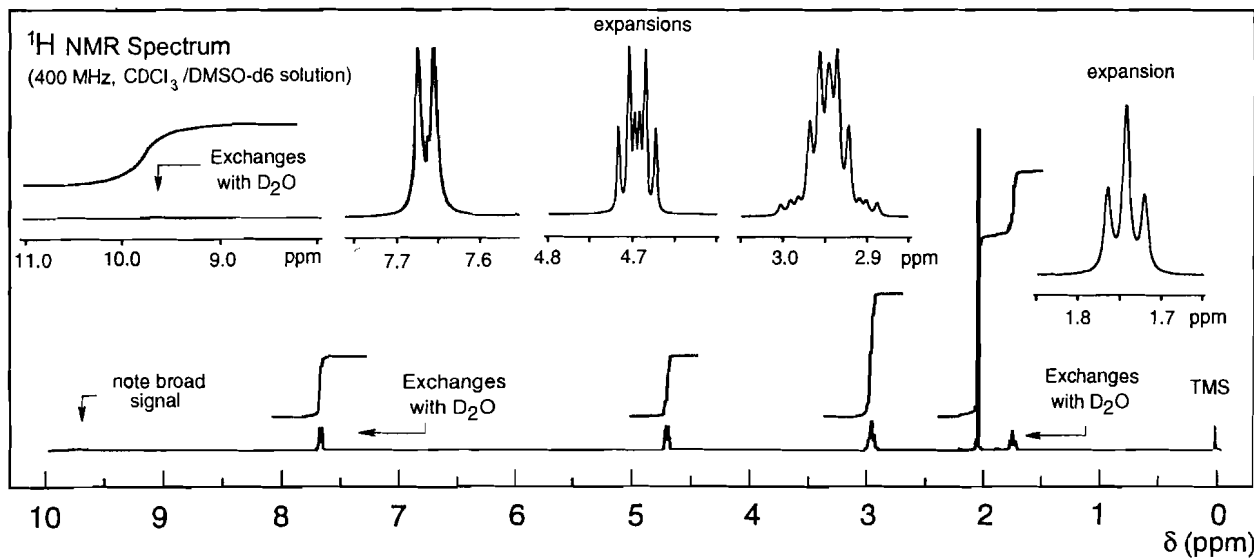
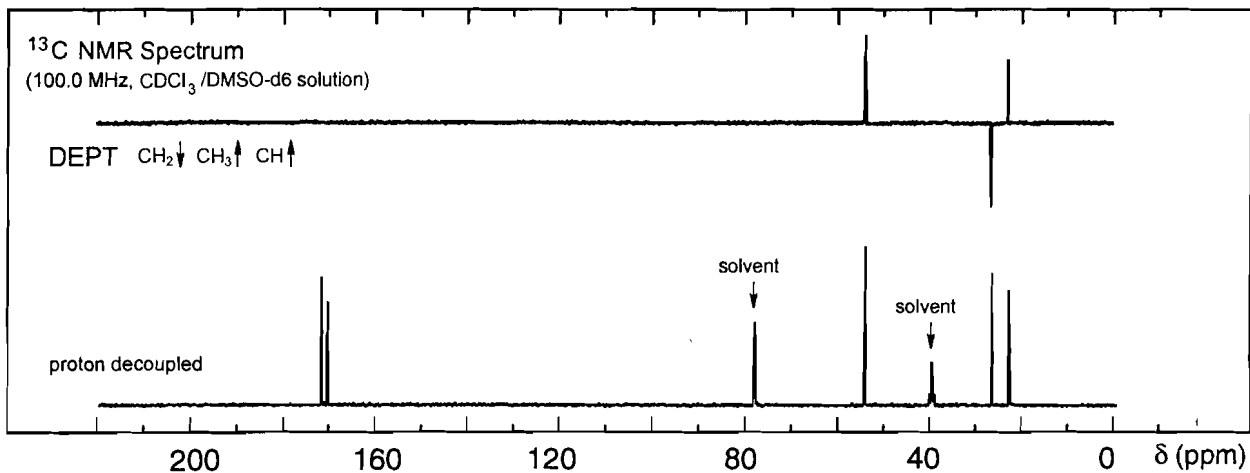

# Problem 257

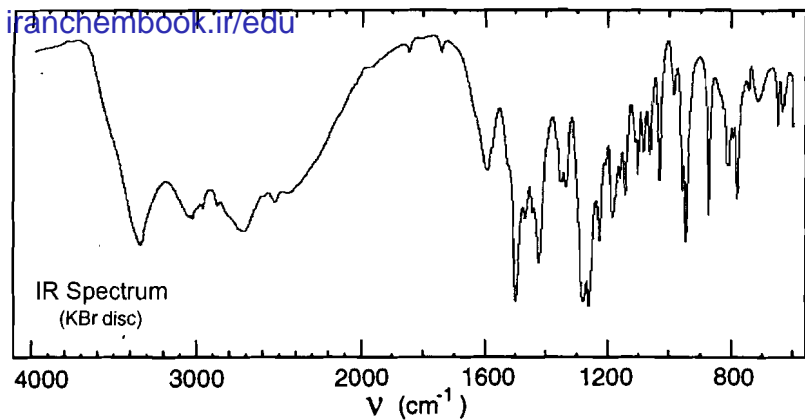

Note: irradiation of the signal at  $\delta$  6.58 in the  $^1\text{H}$  NMR produces an enhancement of the signals at  $\delta$  6.66 and 4.45 ppm via the NOE

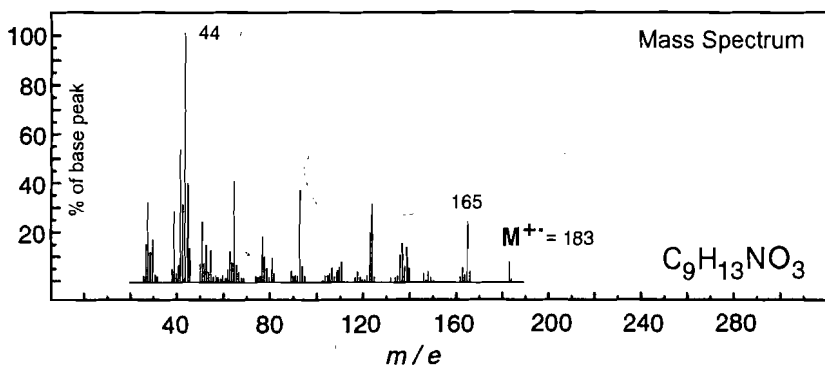

UV Spectrum

$\lambda_{\text{max}}$  220 nm ( $\log_{10} \epsilon$  3.8)

$\lambda_{\text{max}}$  280 nm ( $\log_{10} \epsilon$  3.4)

solvent:  $\text{H}_2\text{O}$  pH 7

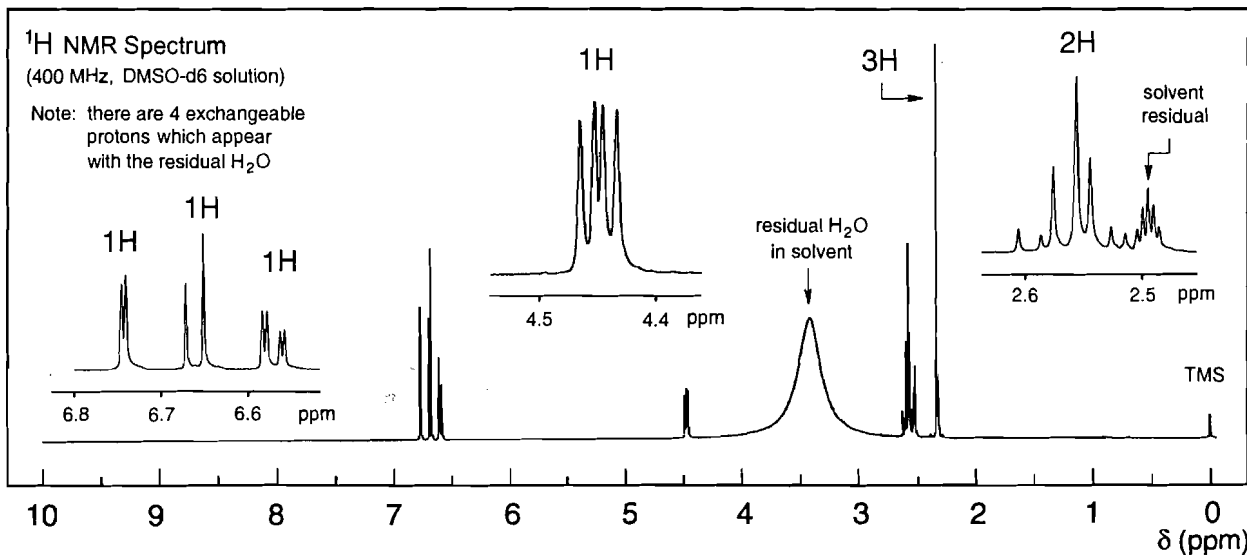
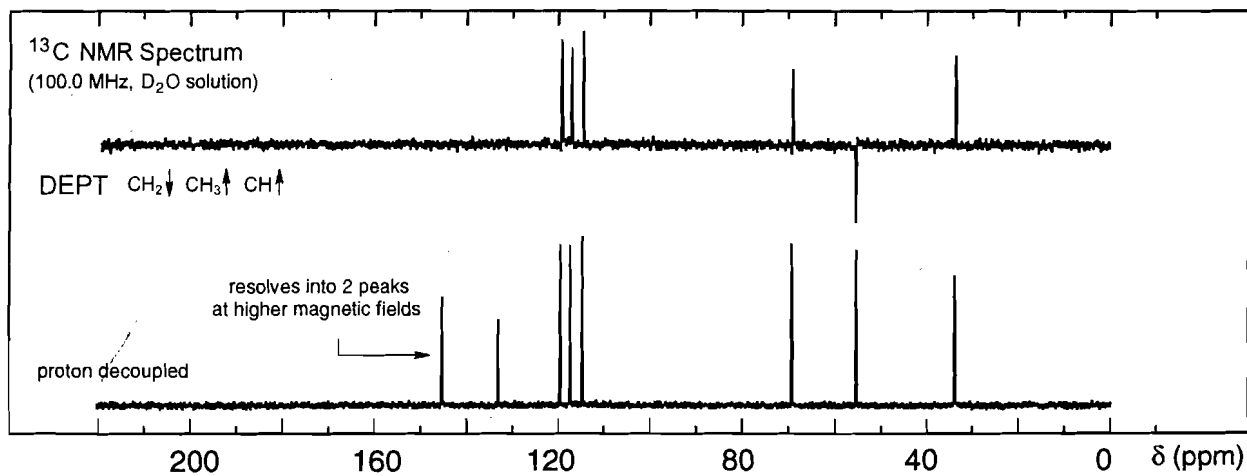

## Problem 258

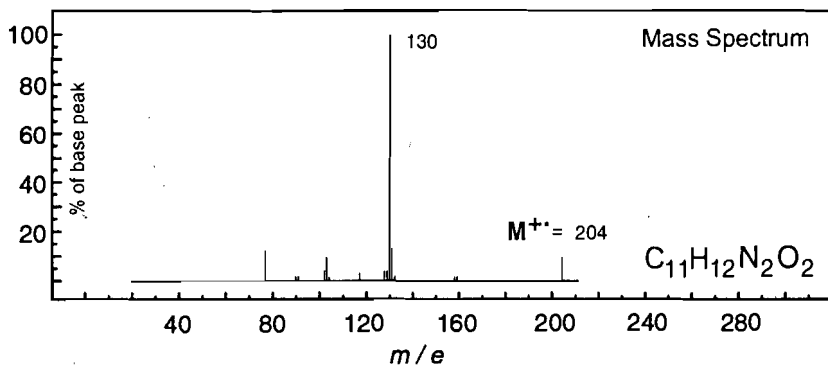
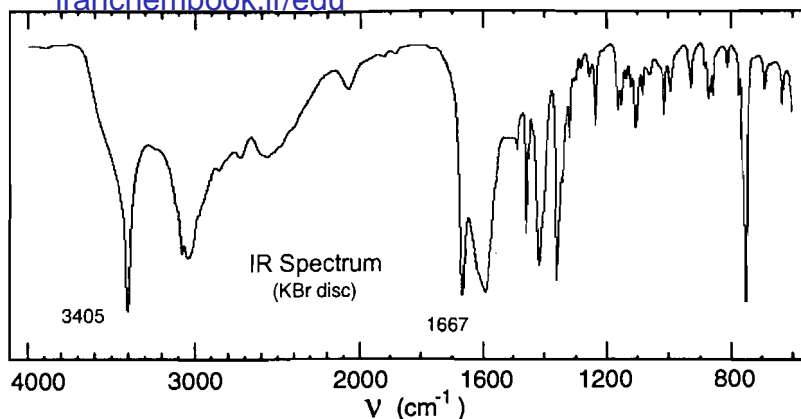

## UV Spectrum

 $\lambda_{\text{max}}$  220 nm ( $\log_{10} \epsilon$  4.6)

 $\lambda_{\text{max}}$  273 nm ( $\log_{10} \epsilon$  3.8)

 $\lambda_{\text{max}}$  280 nm ( $\log_{10} \epsilon$  3.8)

 $\lambda_{\text{max}}$  289 nm ( $\log_{10} \epsilon$  3.7)

solvent: methanol

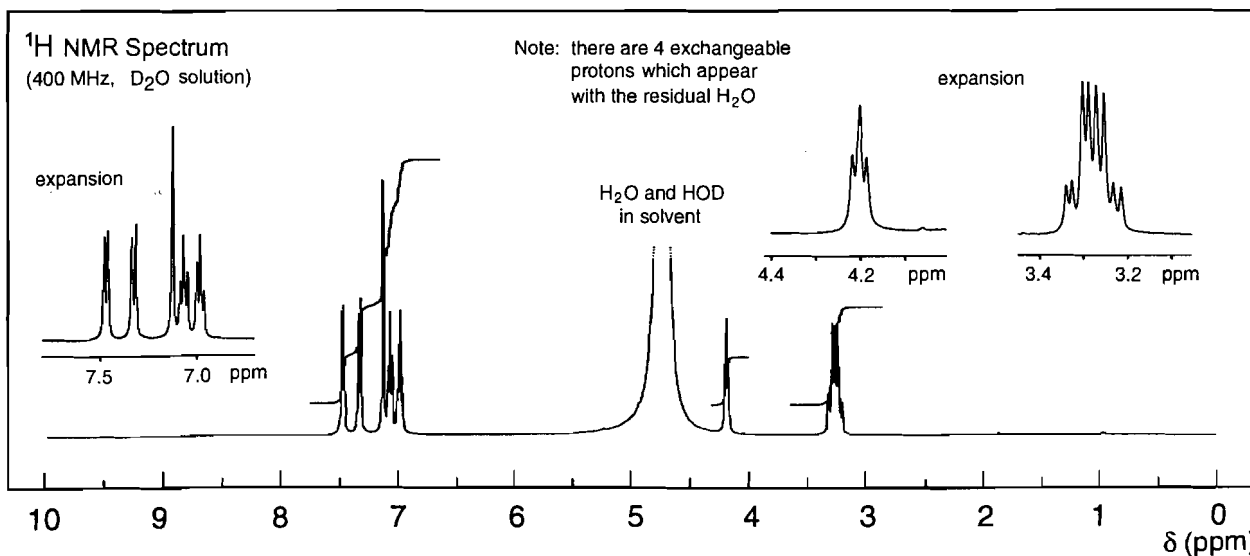
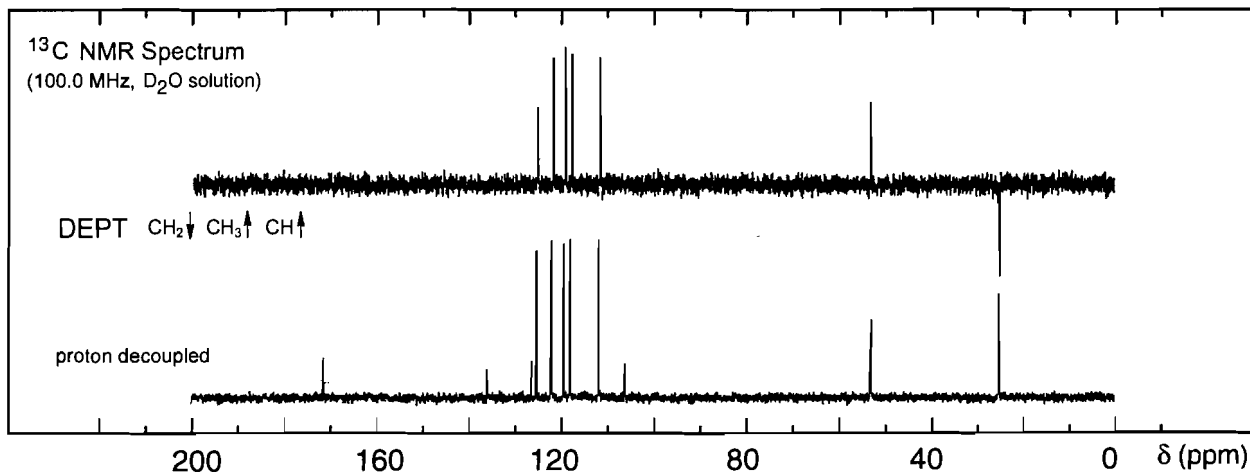

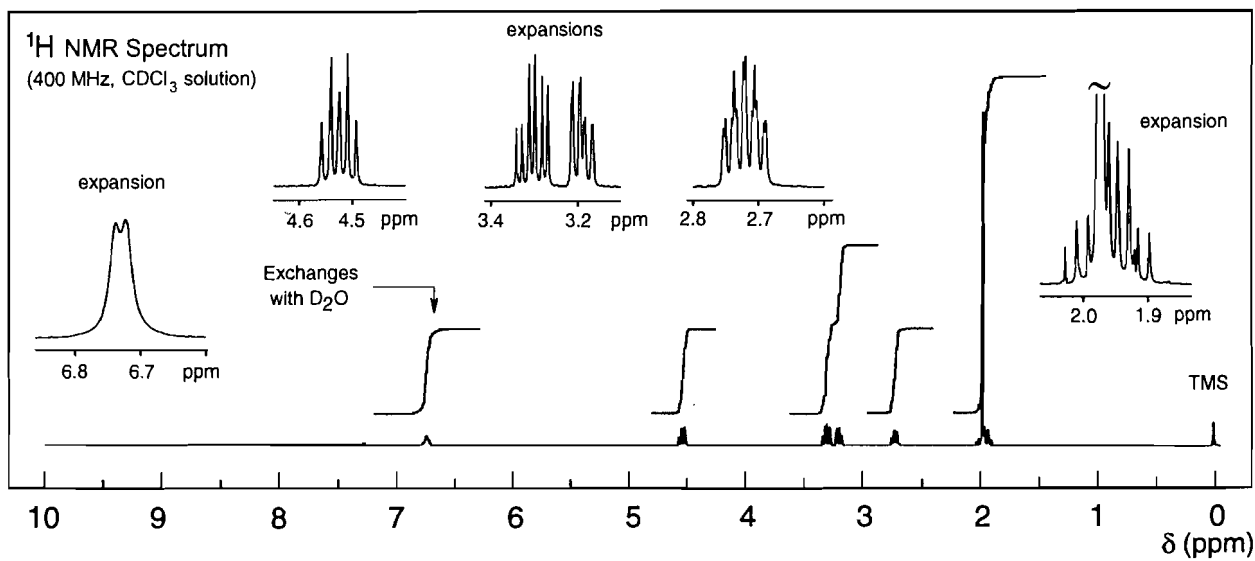
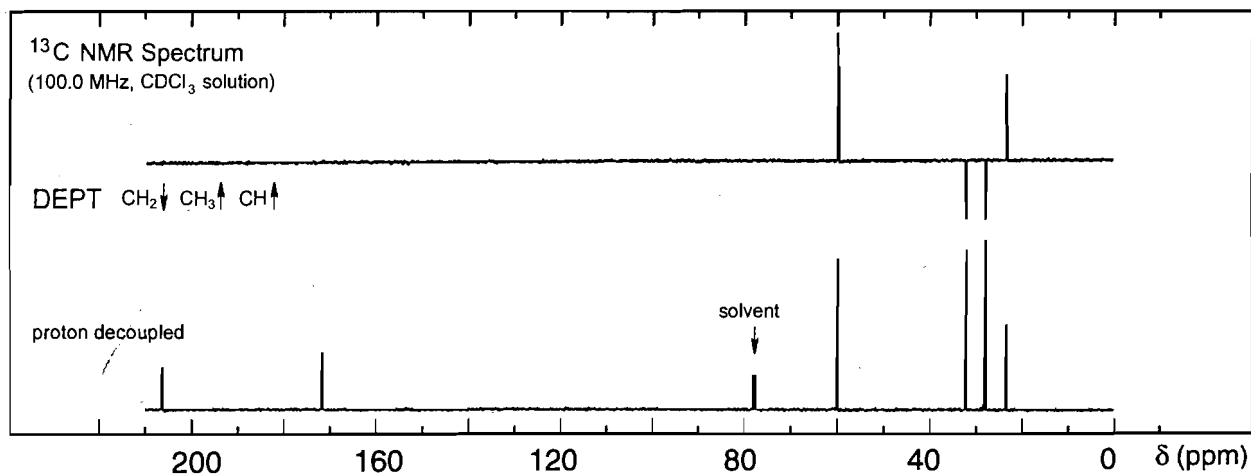
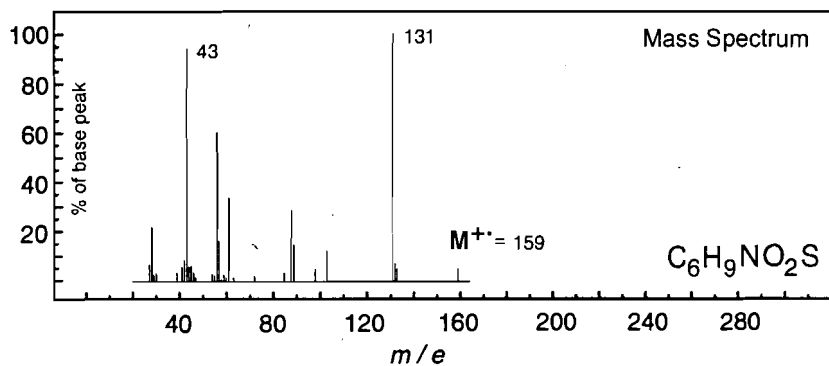
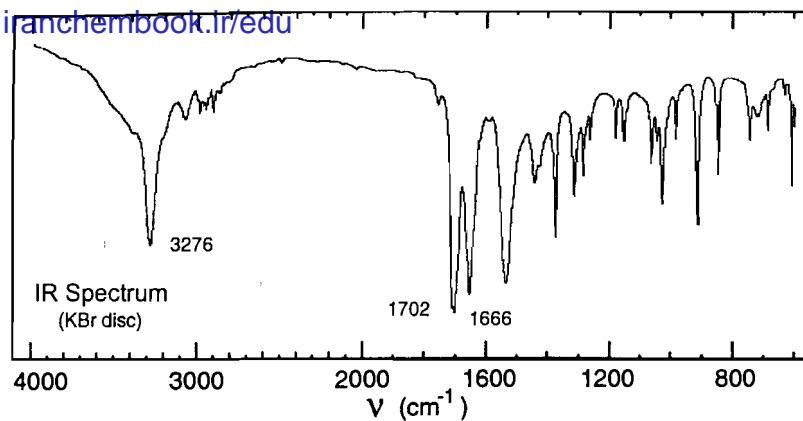

# Problem 260

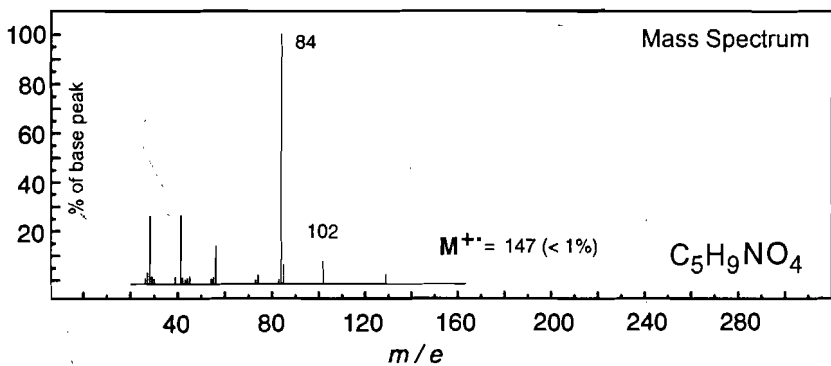
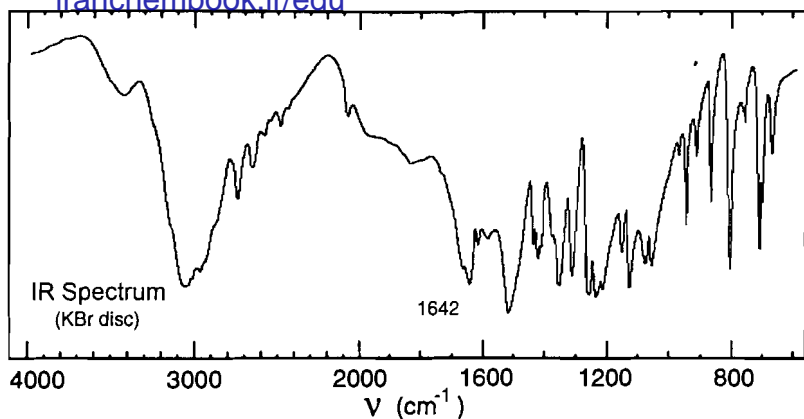

No significant UV absorption above 220 nm

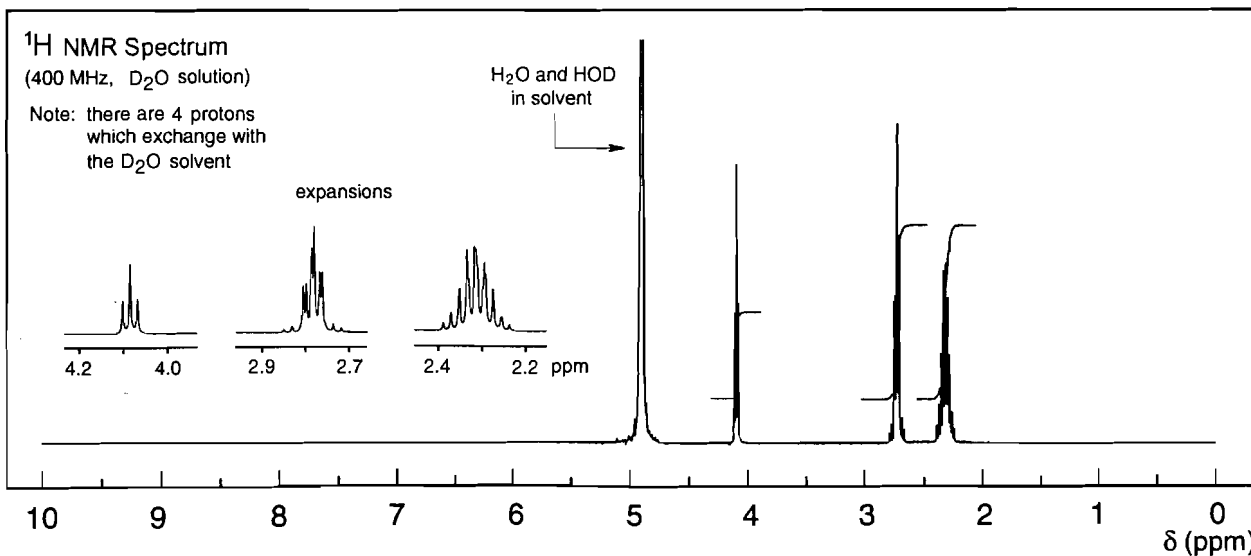
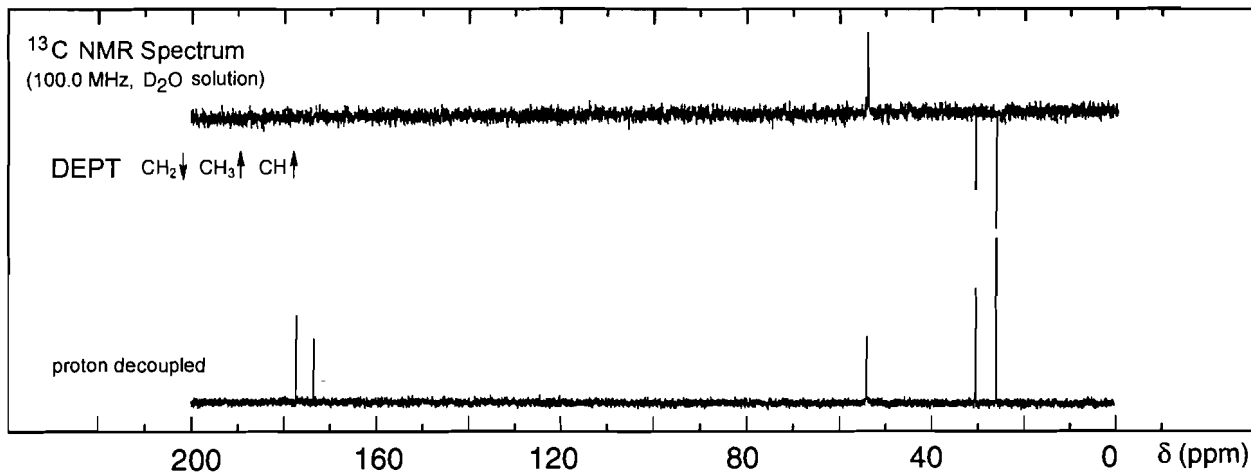

# Problem 261

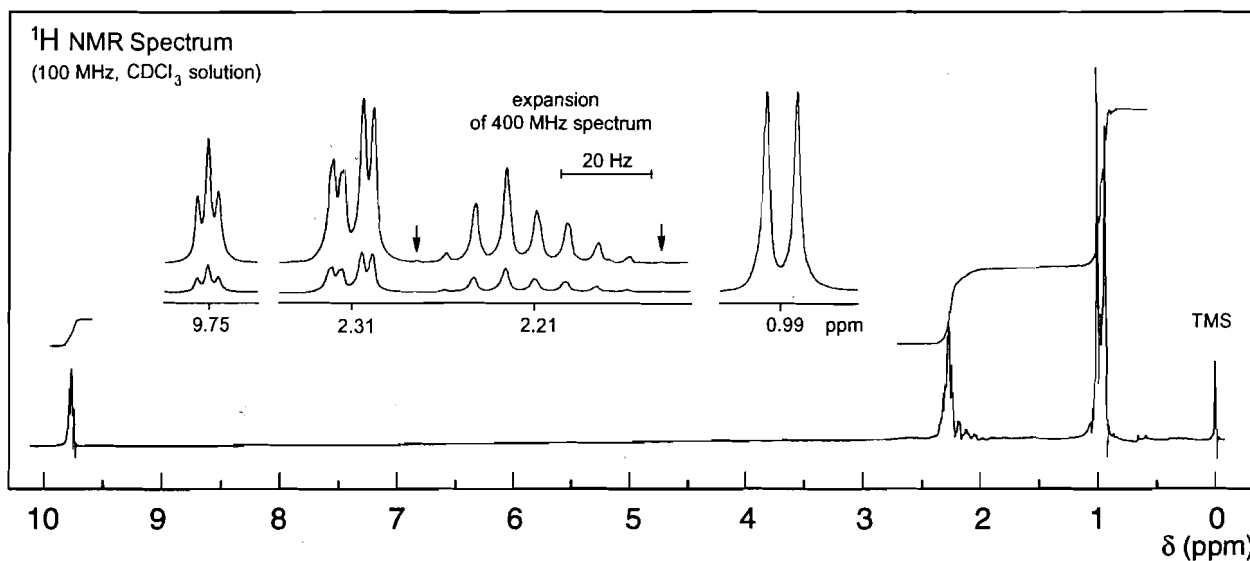
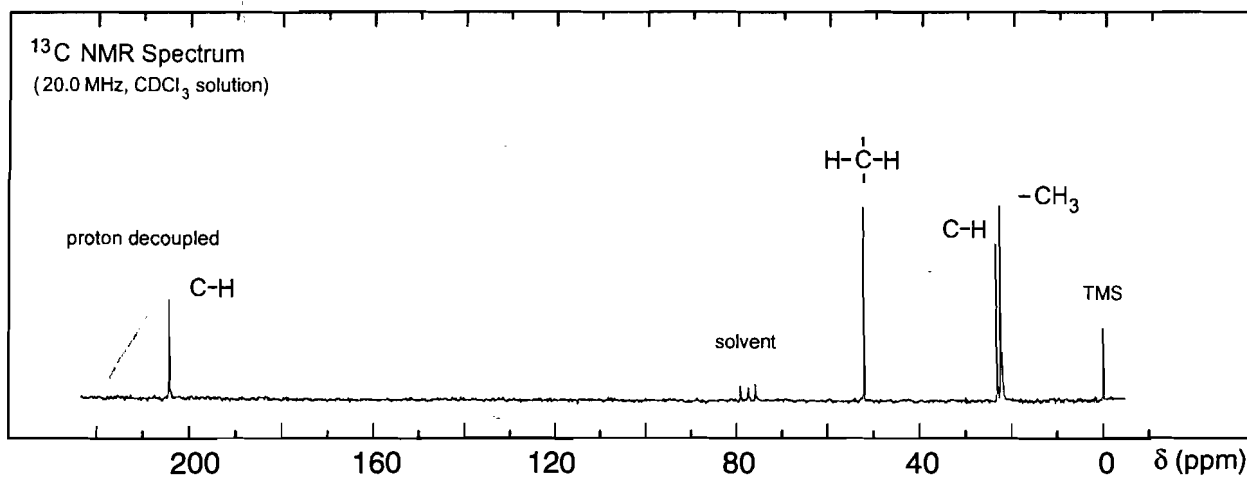
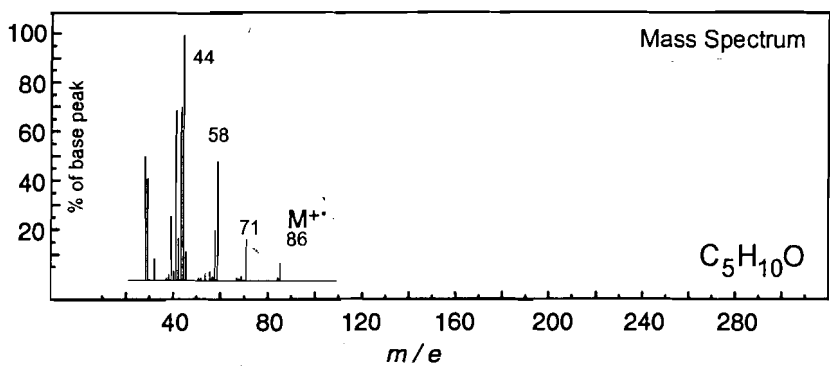
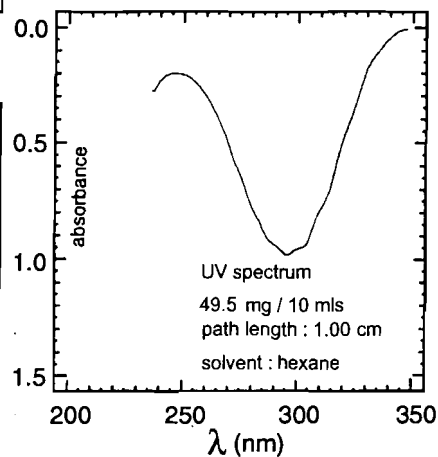
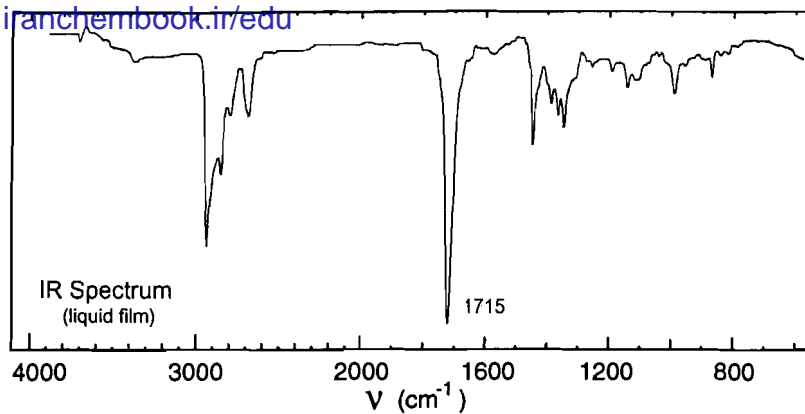

## Problem 262

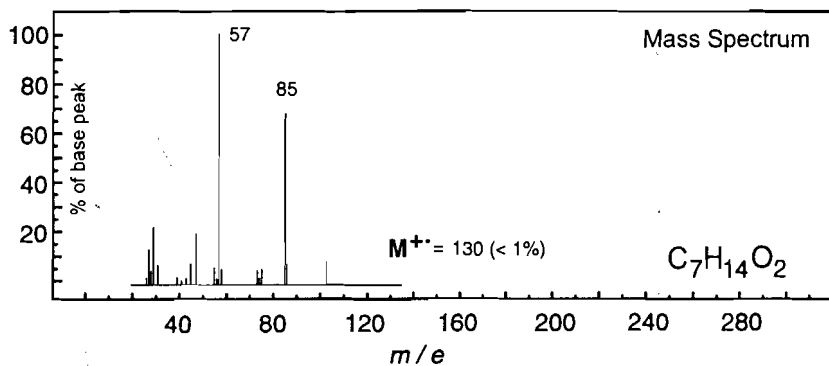
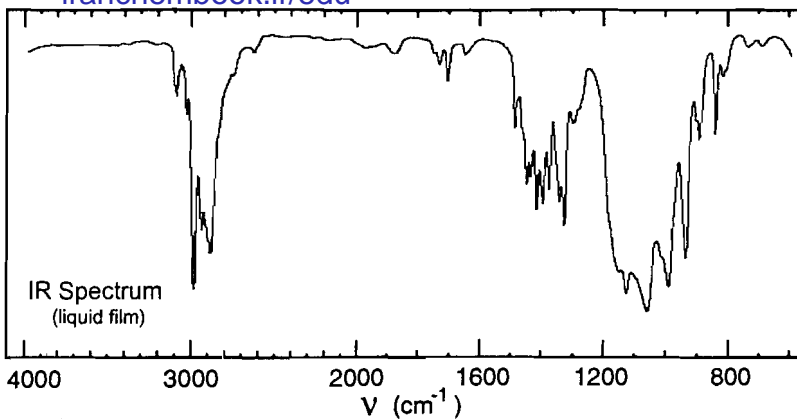

No significant UV  
absorption above 220 nm

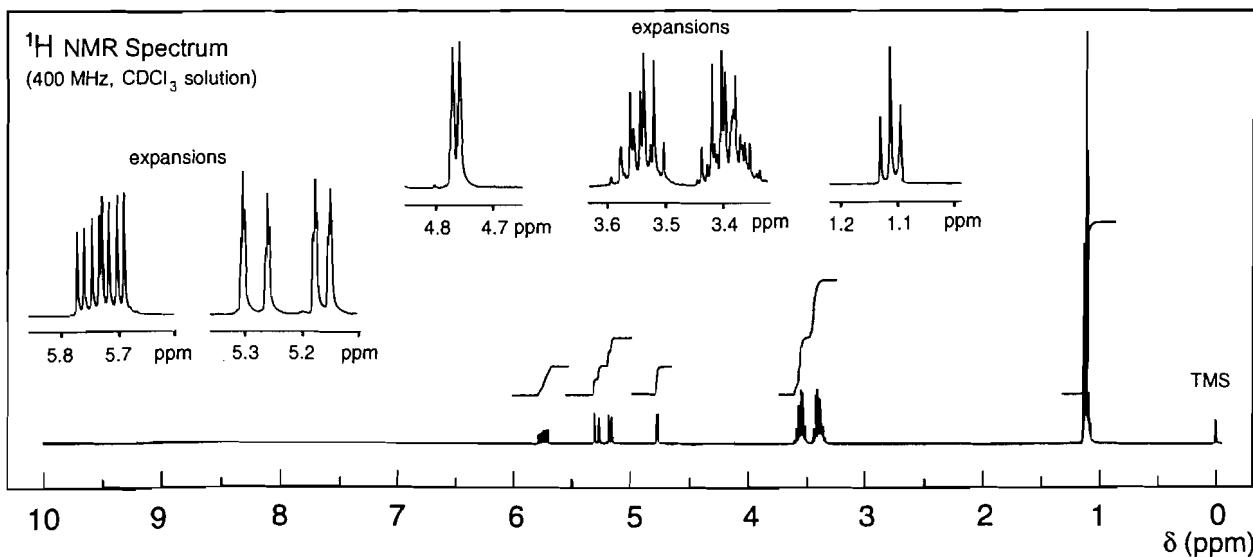
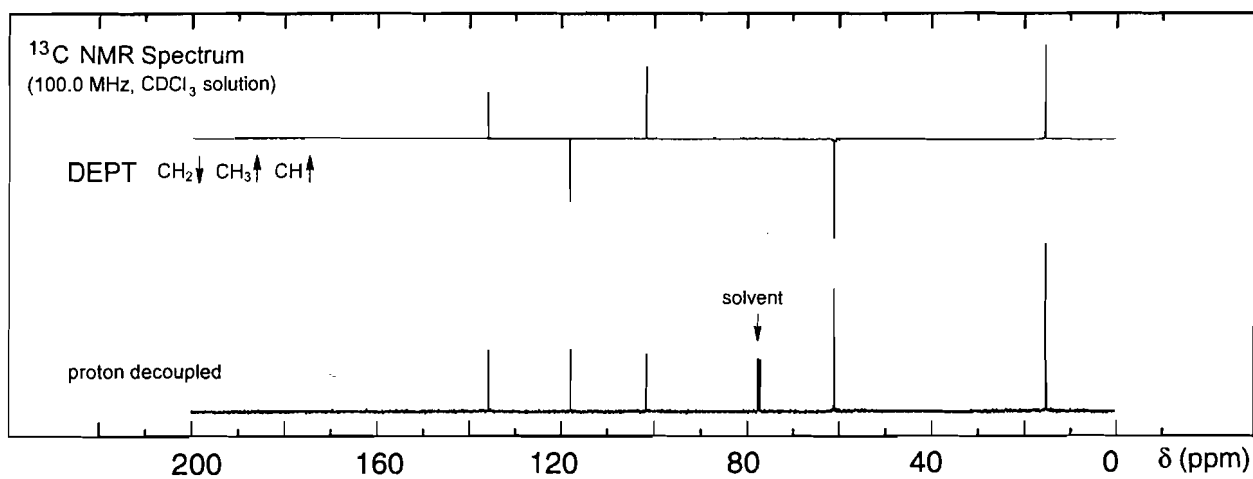



## Problem 263a

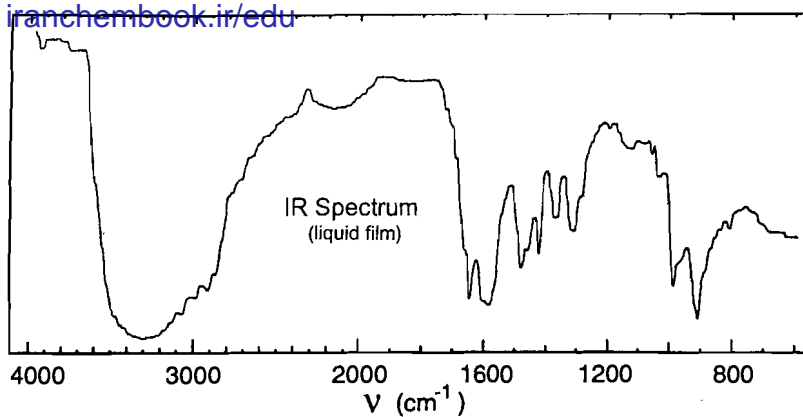

A 400 MHz  $^1\text{H}$  NMR spectrum (with expansions)  
is given on the following page

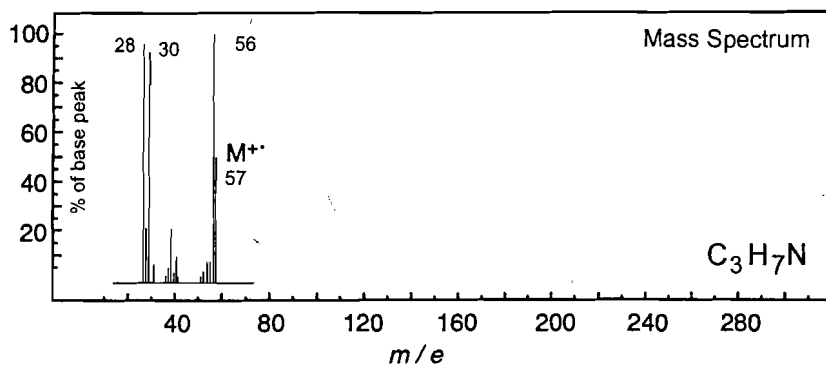

No significant UV  
absorption above 220 nm

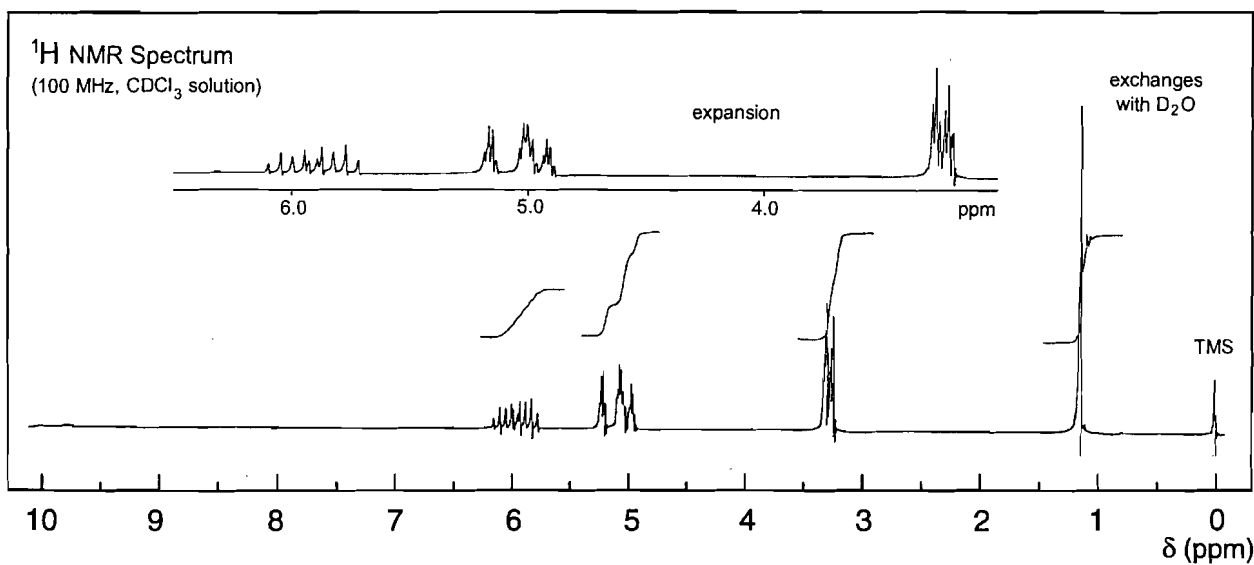
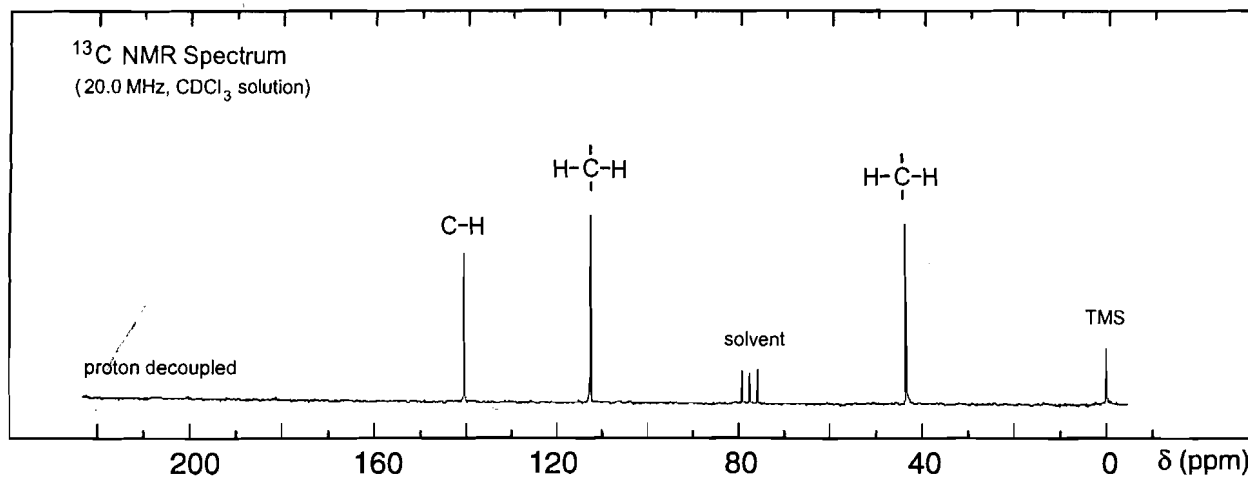

## Problem 263b

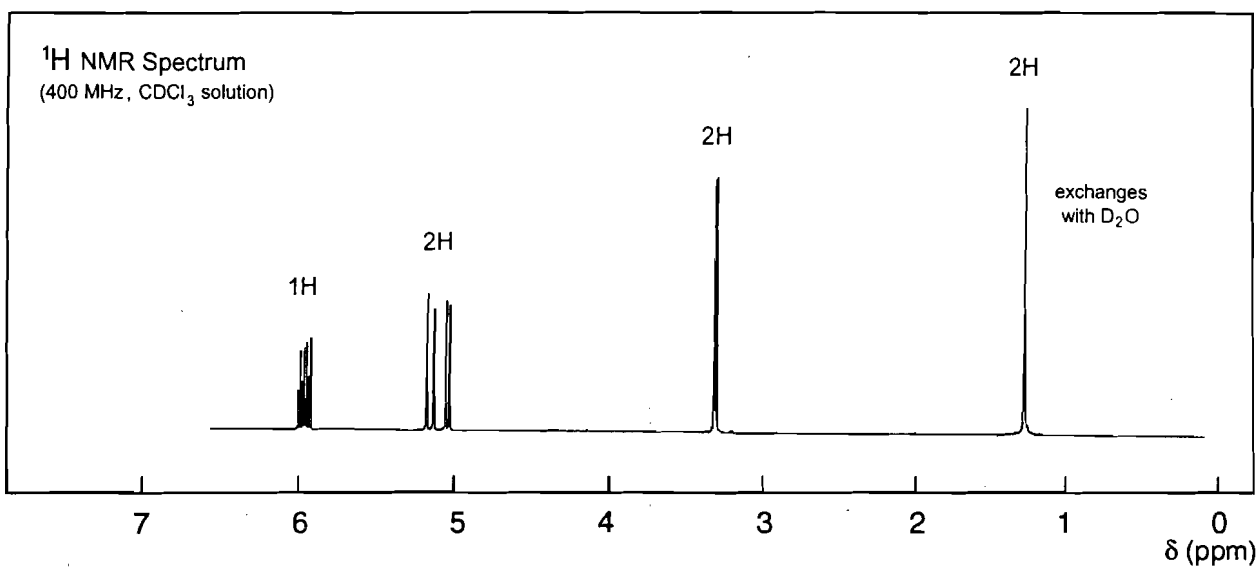

Expansion of regions  
of the 400 MHz NMR spectrum

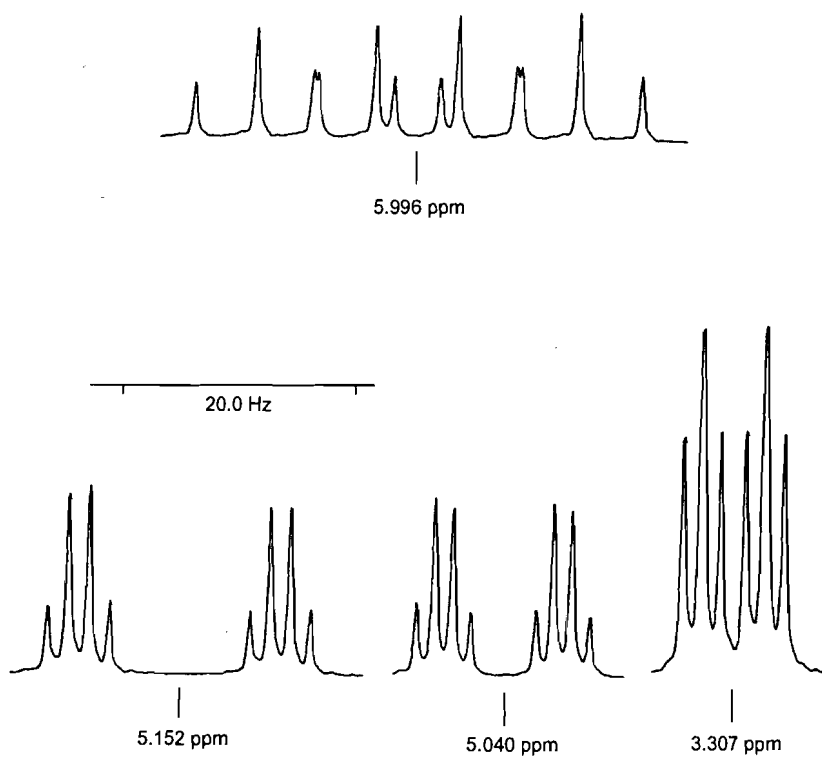

## Problem 264

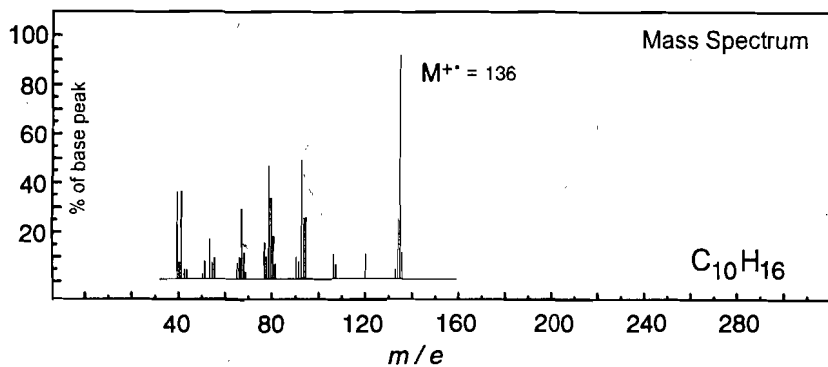
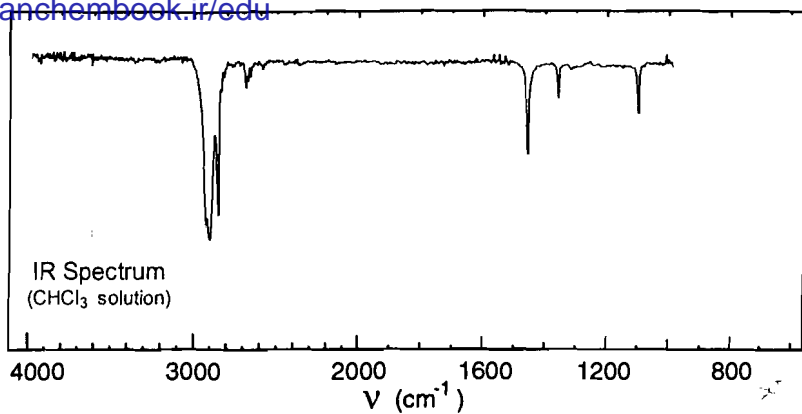

No significant UV  
absorption above 220 nm

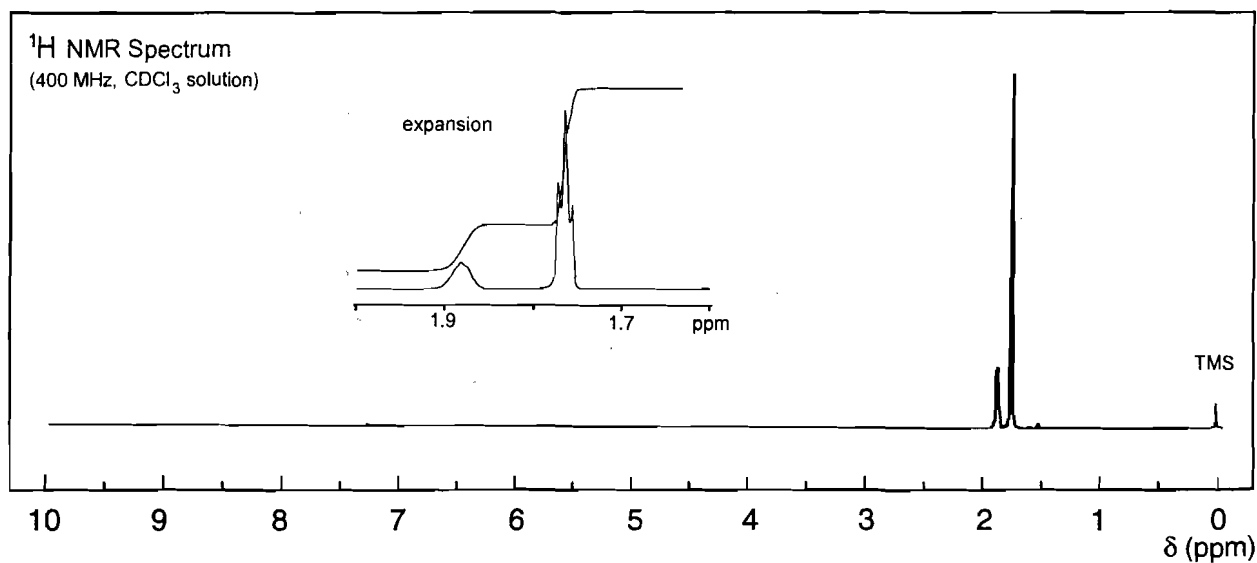
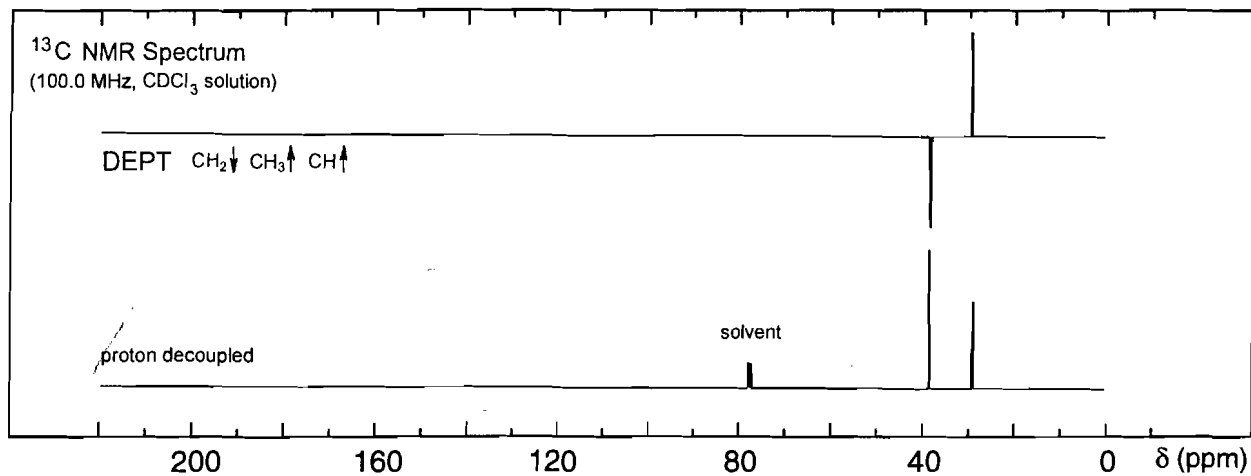

# Problem 265

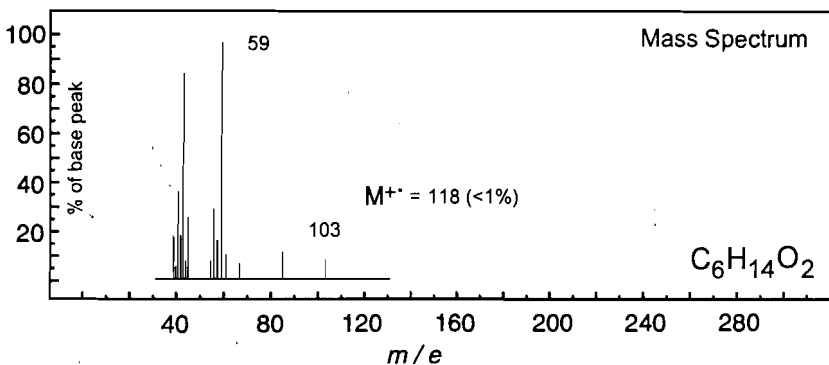
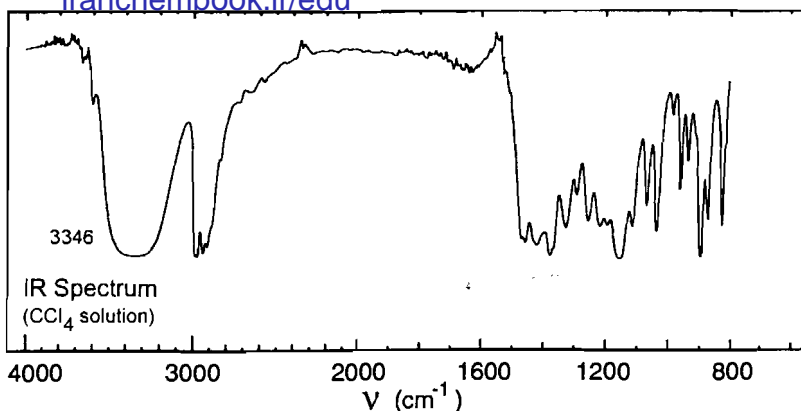

No significant UV  
absorption above 220 nm

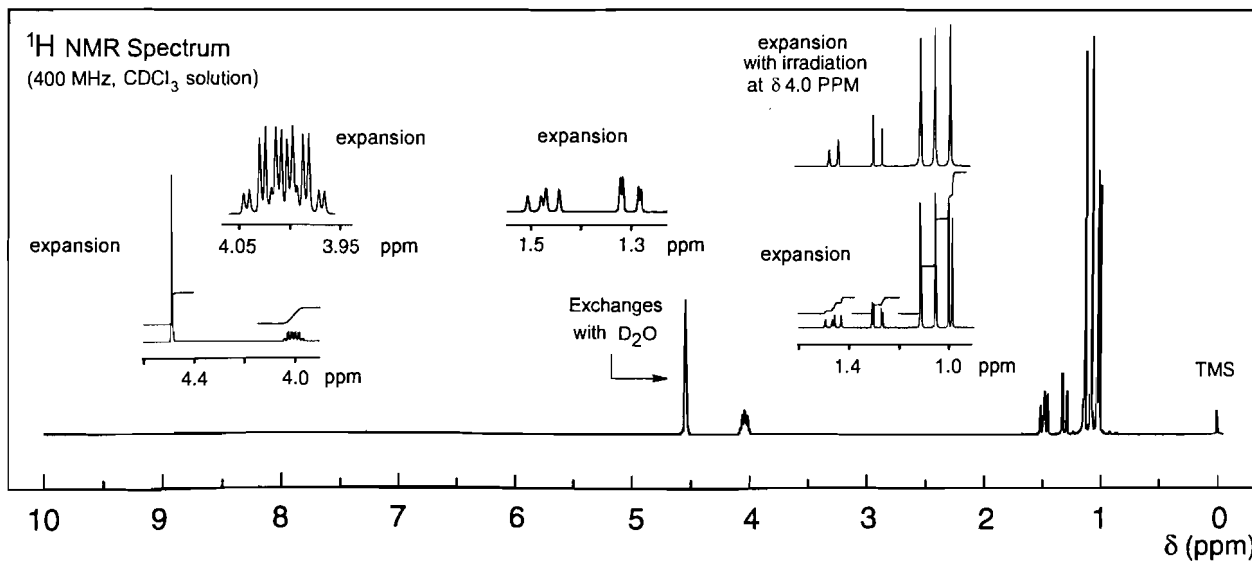
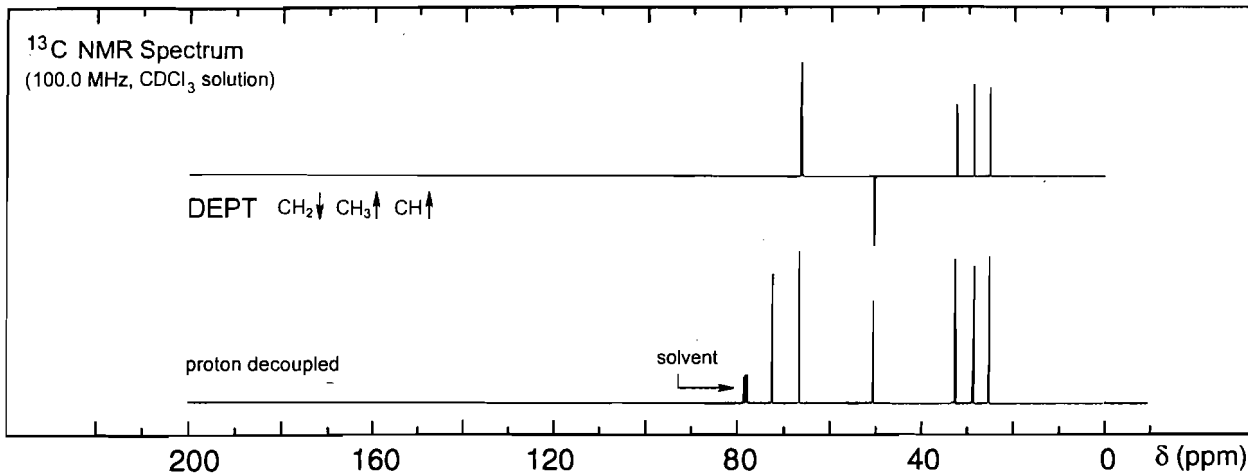

## Problem 266

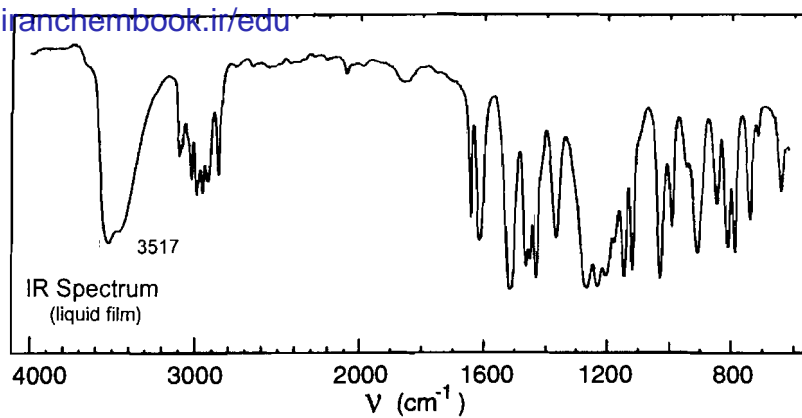

Note: irradiation of the signal at  $\delta$  6.45 in the  $^1\text{H}$  NMR produces an enhancement of the signals at  $\delta$  3.4 and 3.7 ppm via the NOE

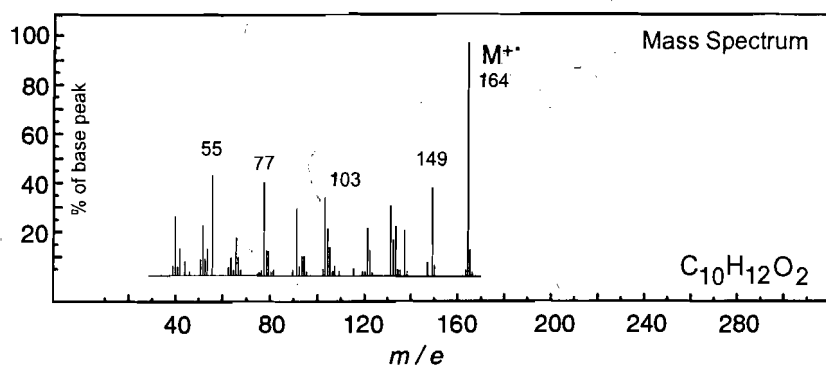

UV Spectrum

$\lambda_{\text{max}}$  281 nm ( $\log_{10} \epsilon$  3.5)

$\lambda_{\text{max}}$  230 nm ( $\log_{10} \epsilon$  3.6)

solvent : methanol

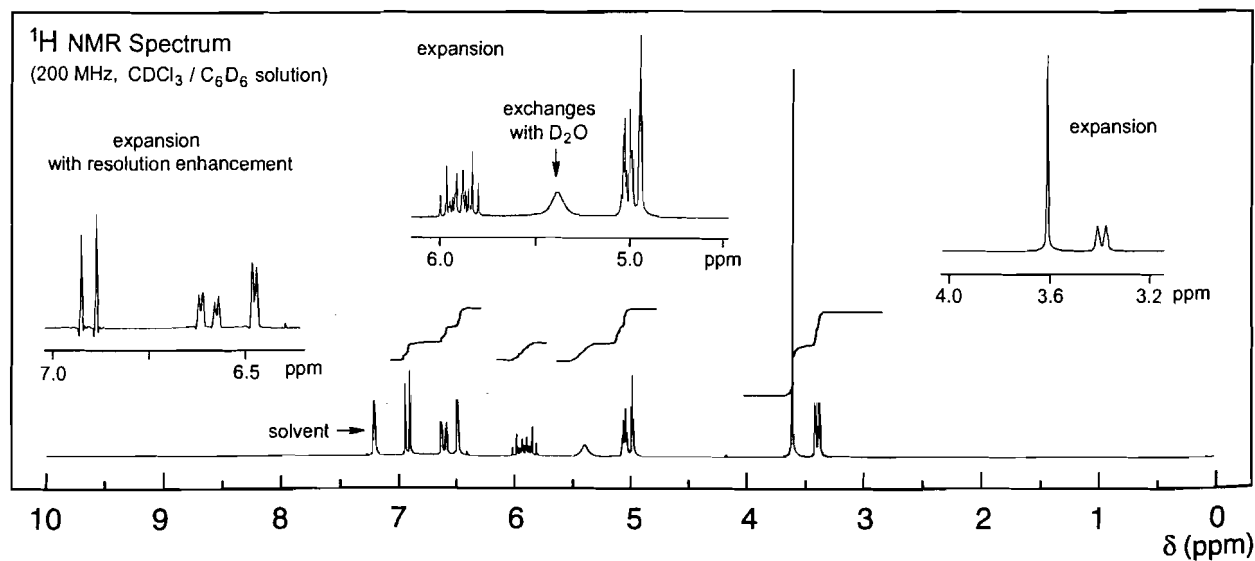
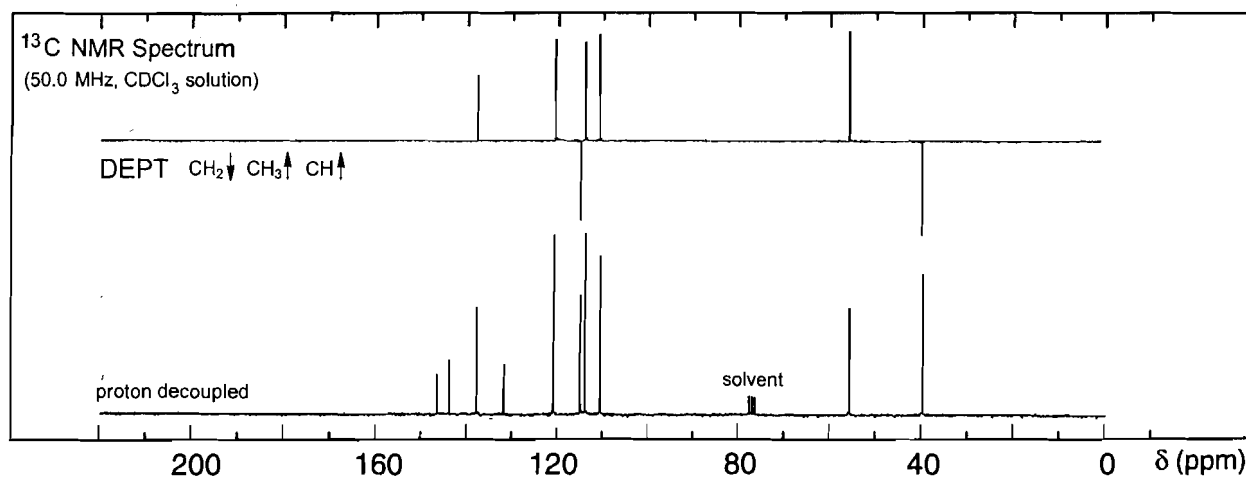

## Problem 267

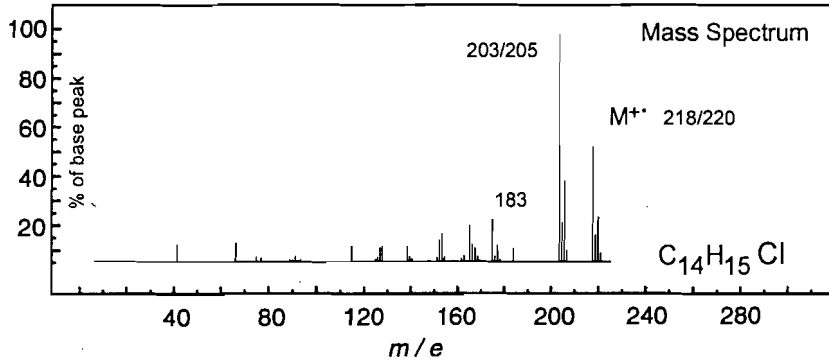
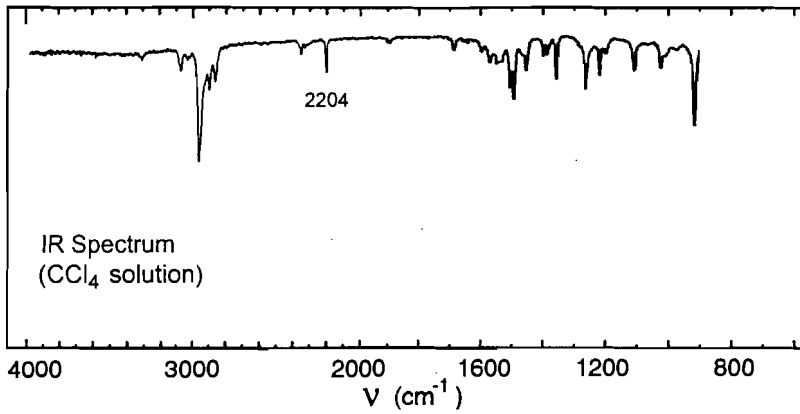

UV Spectrum

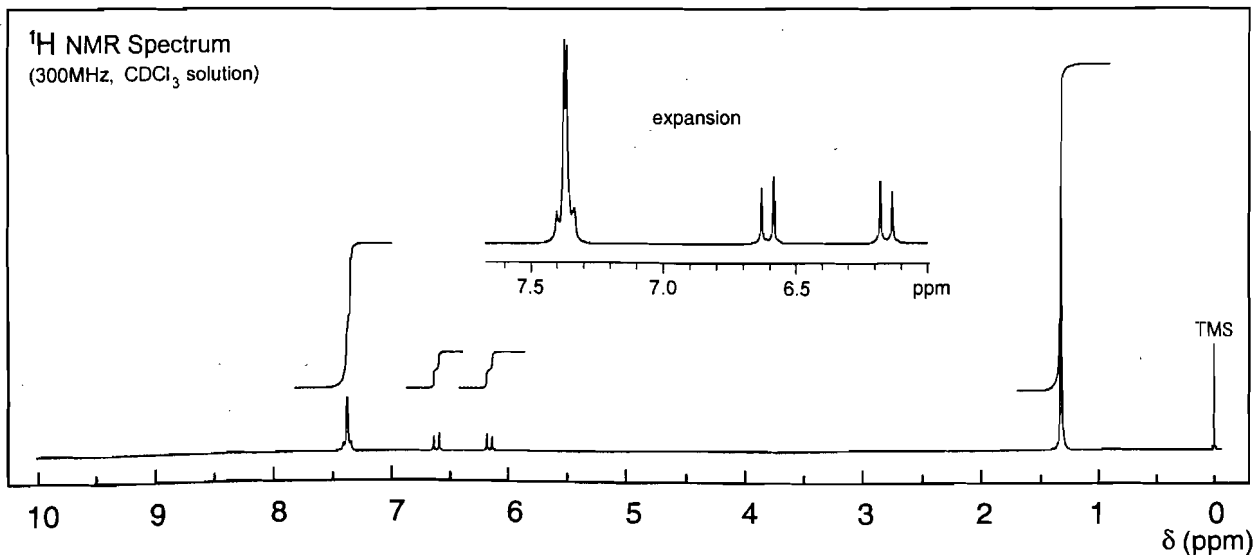
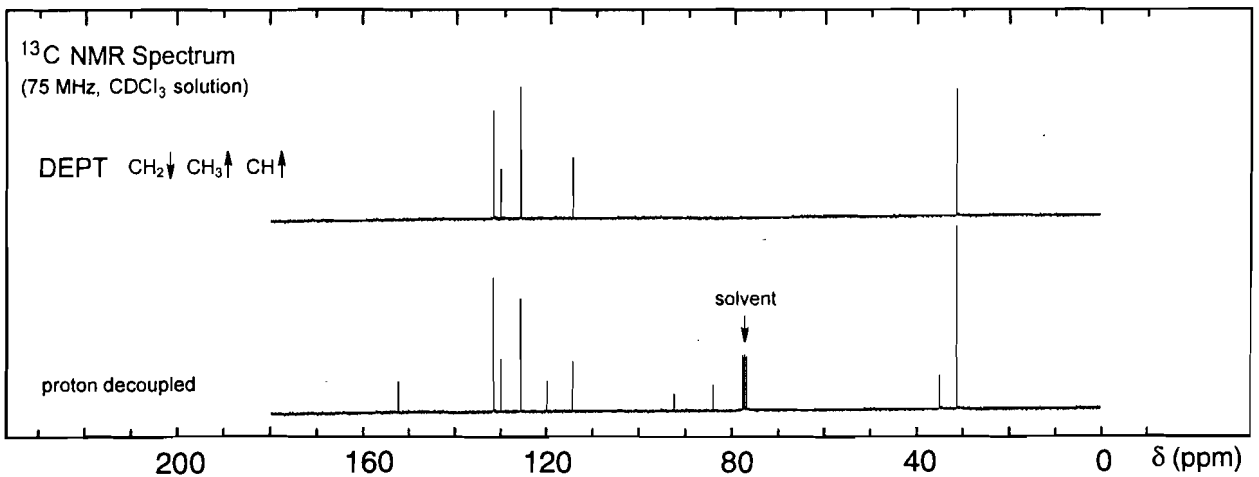
 $\log_{10} \epsilon > 4.5$ 

## Problem 268

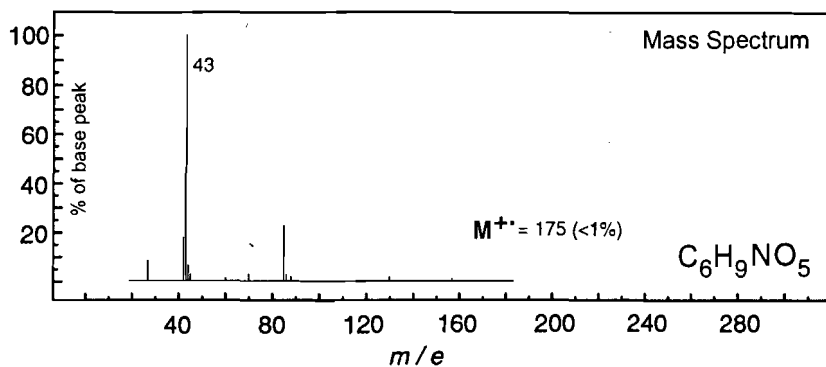
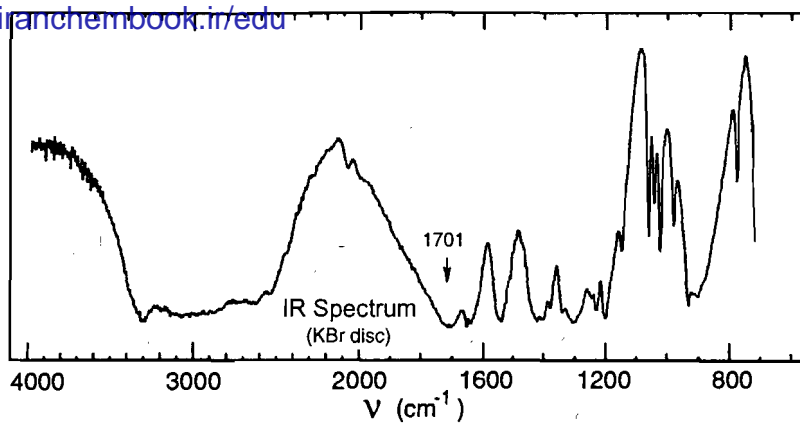

No significant UV  
absorption above 220 nm

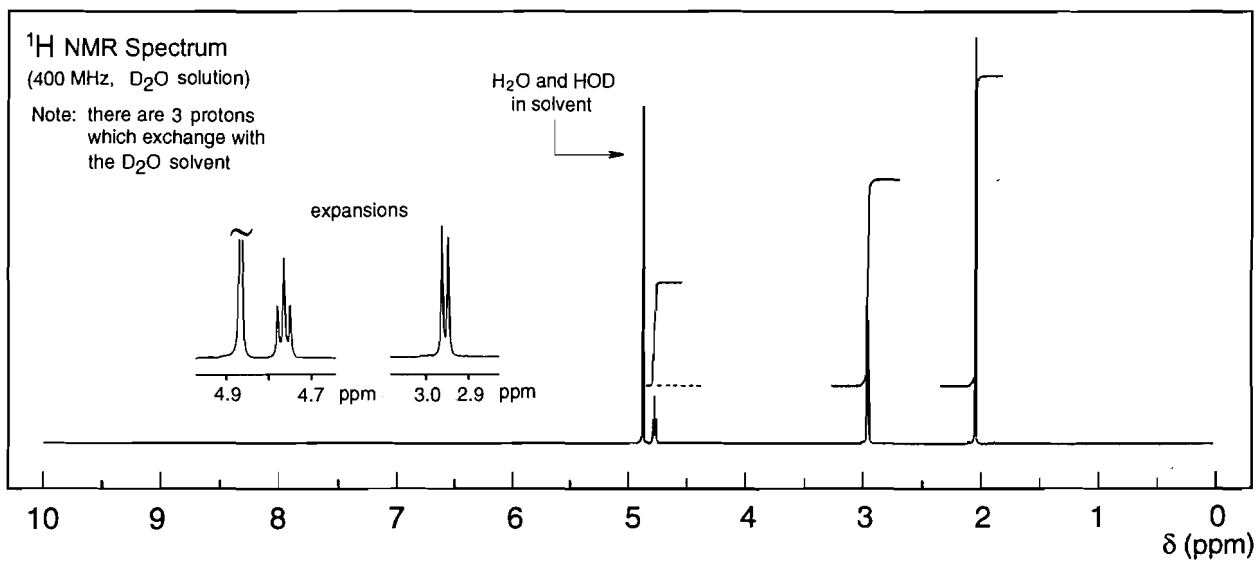
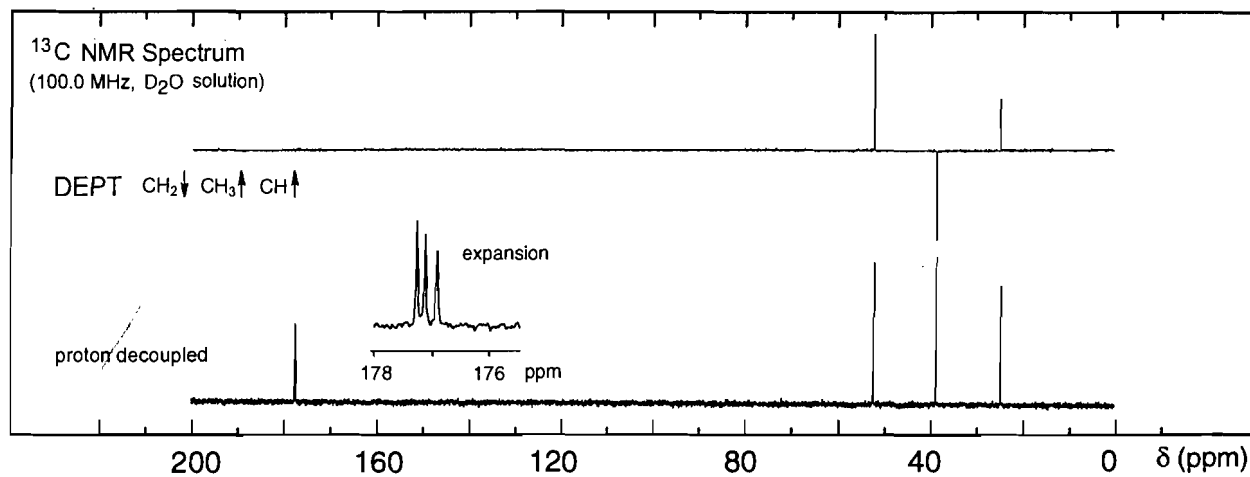

## Problem 269

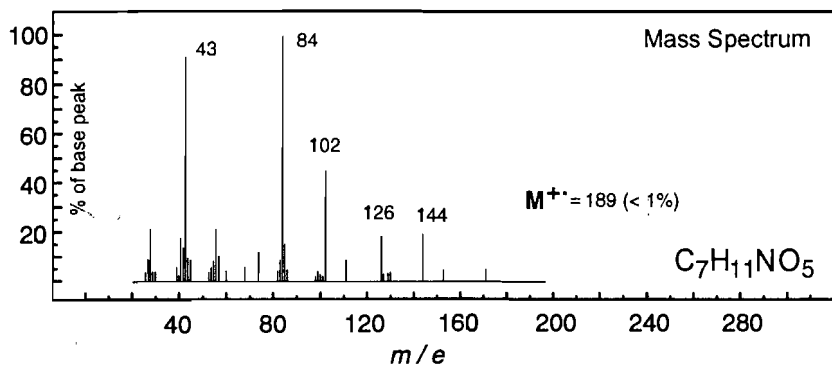
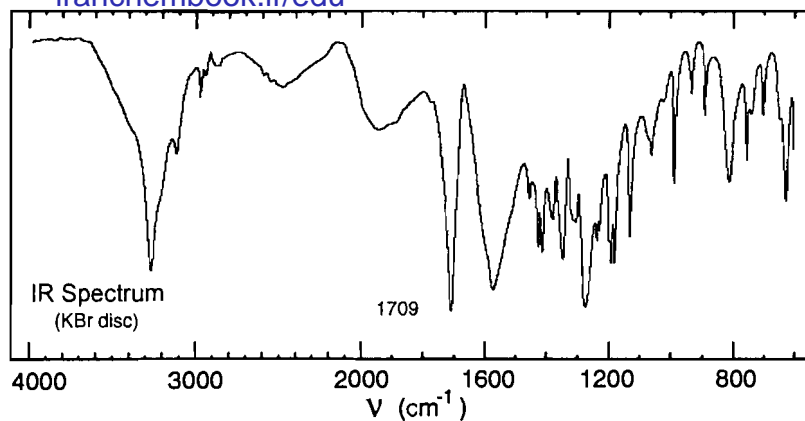

No significant UV  
absorption above 220 nm

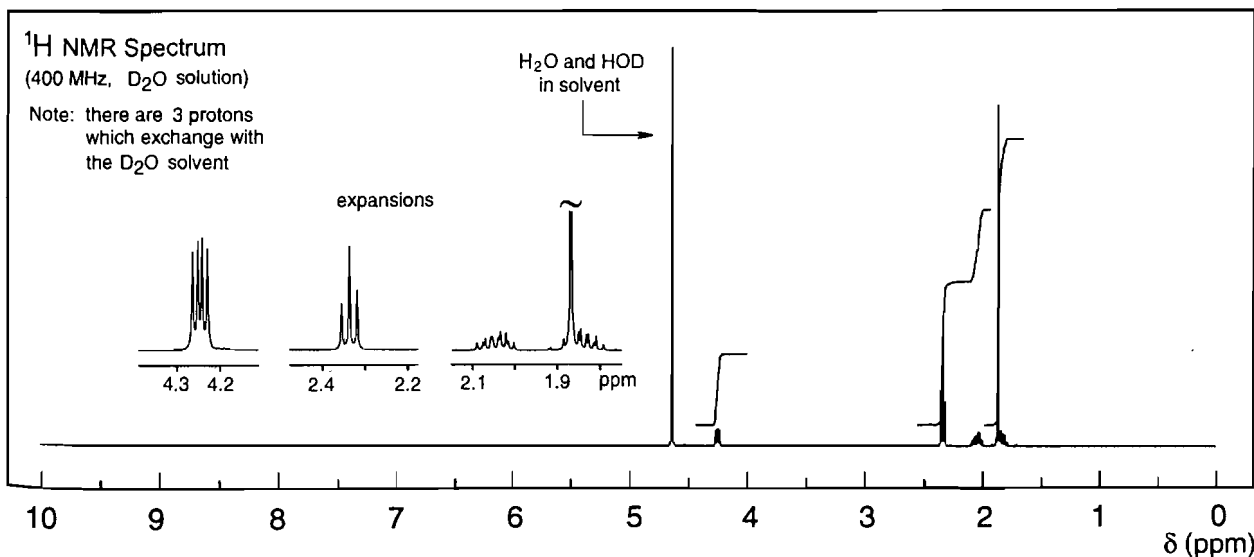
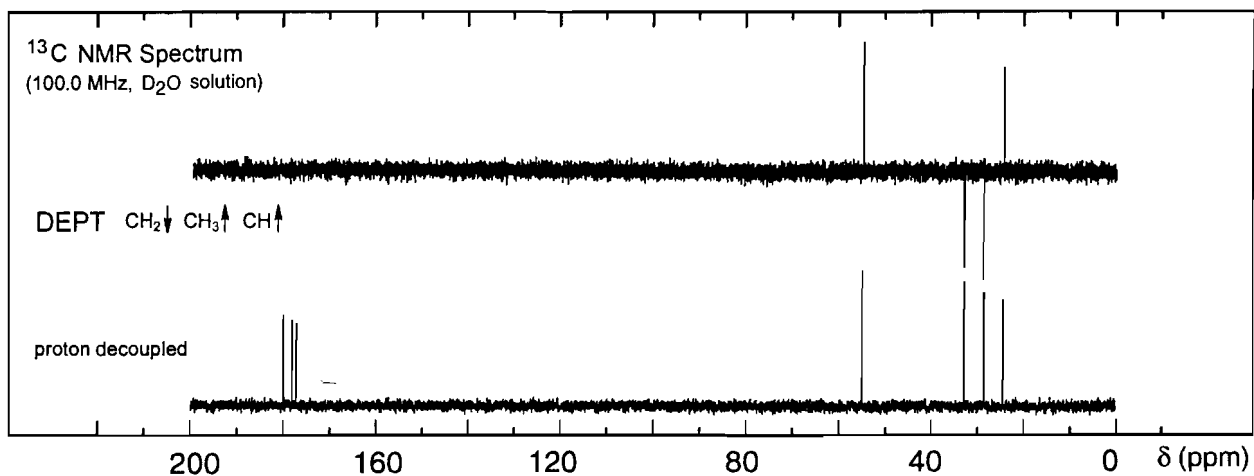



## Problem 270

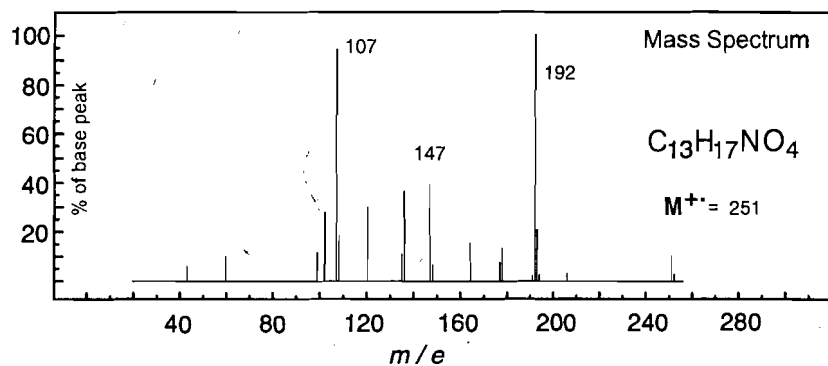
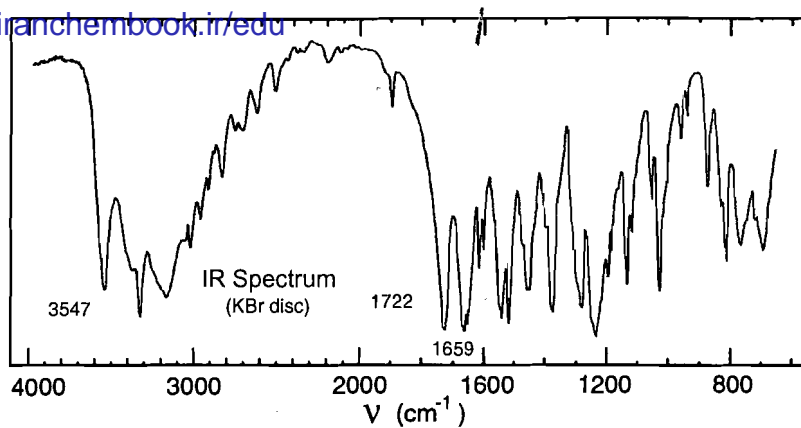

UV Spectrum

$$\lambda_{\max} \approx 215 \text{ nm } (\log_{10} \epsilon \text{ 3-4})$$

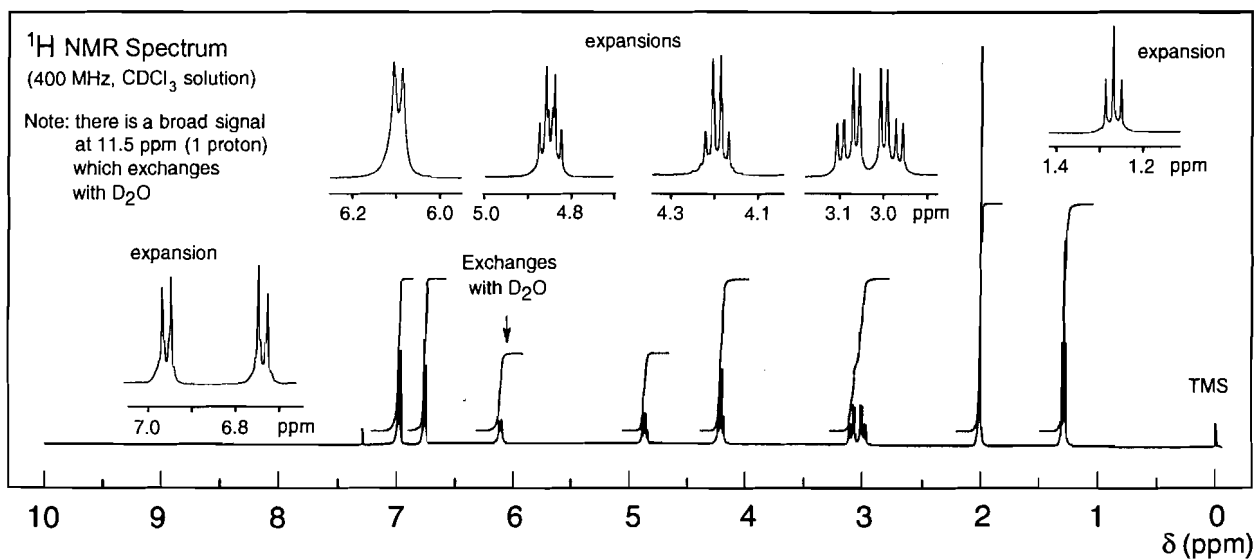
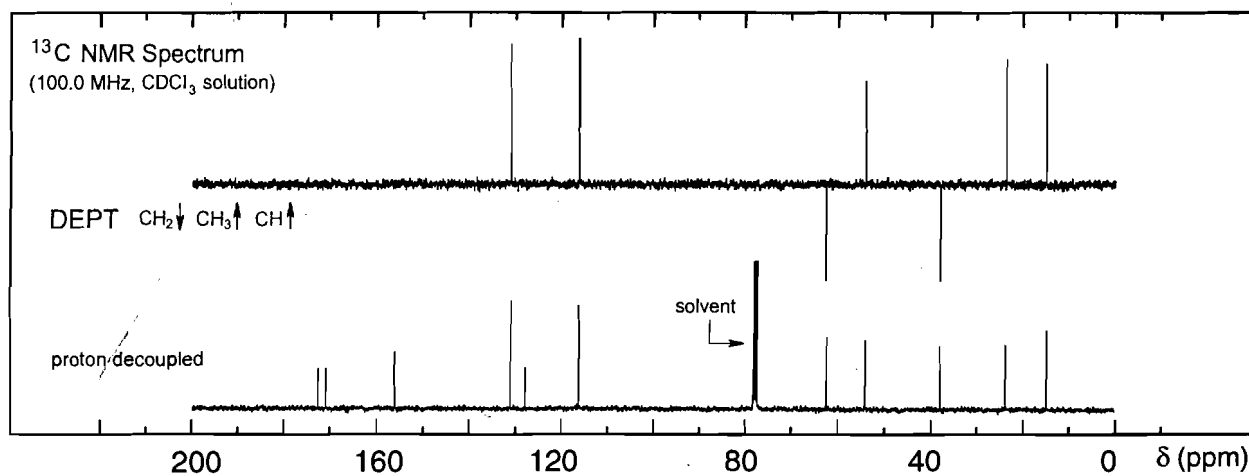

## Problem 271

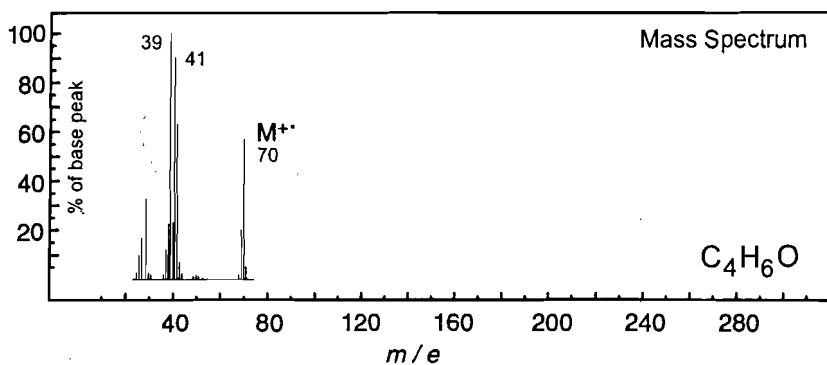
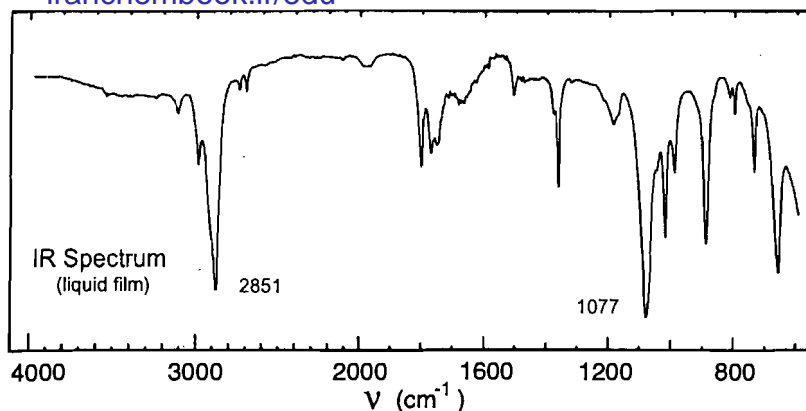

No significant UV  
absorption above 220 nm

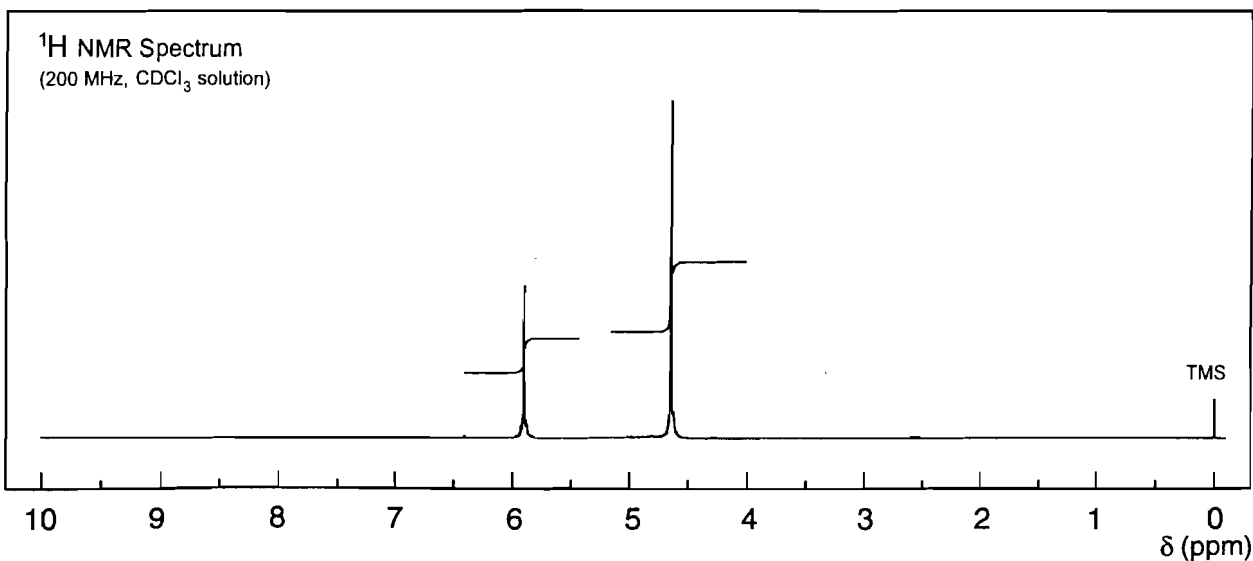
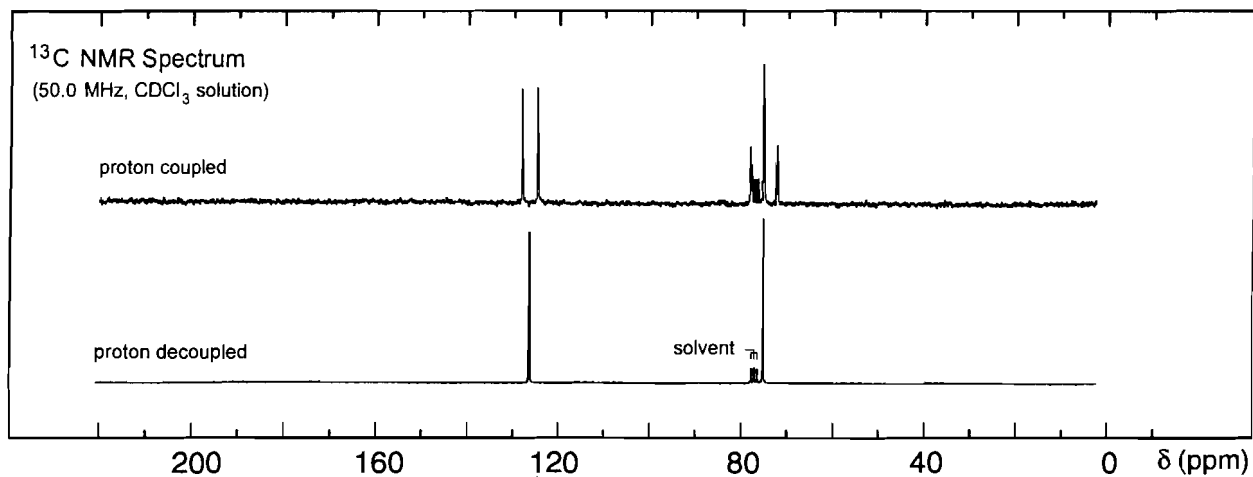

# Problem 272

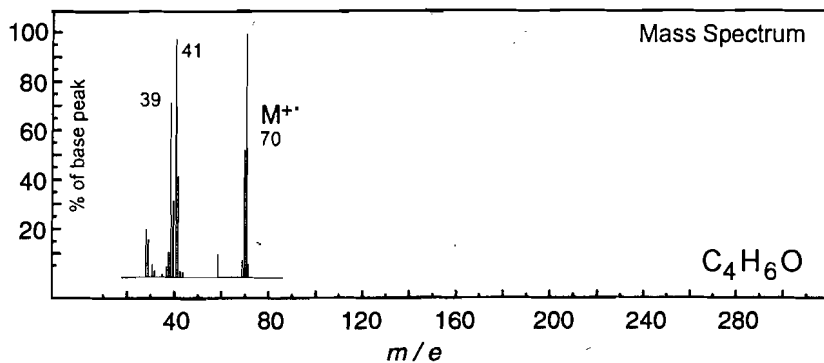
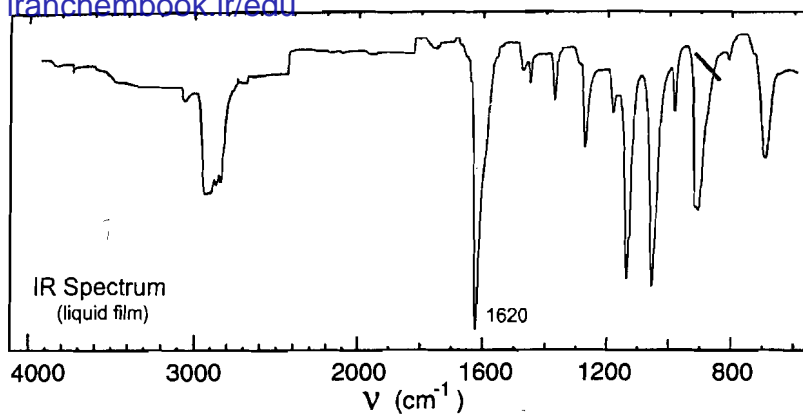

No significant UV  
absorption above 220 nm

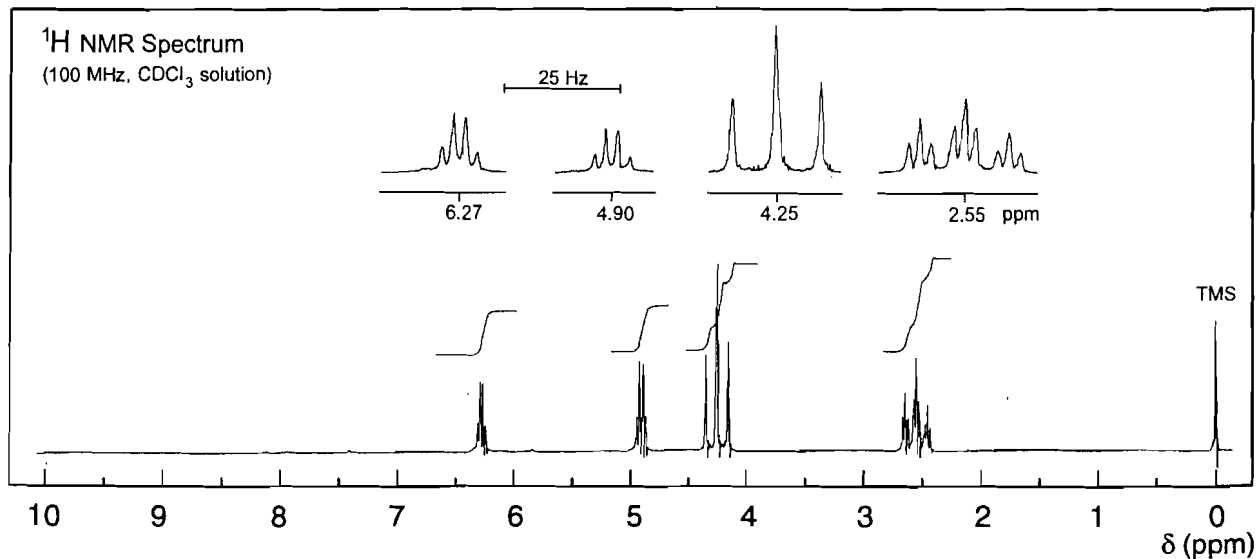
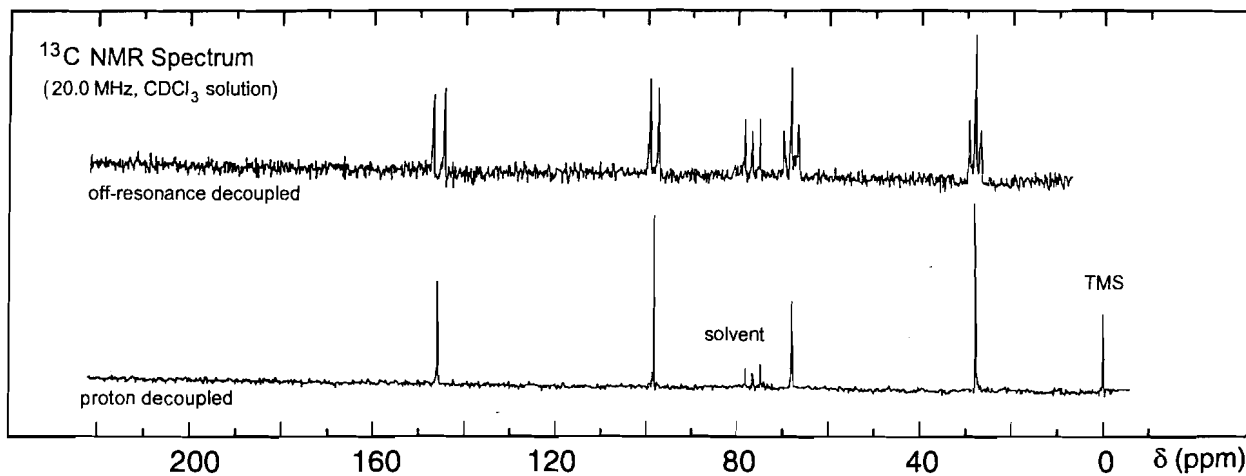

## Problem 273

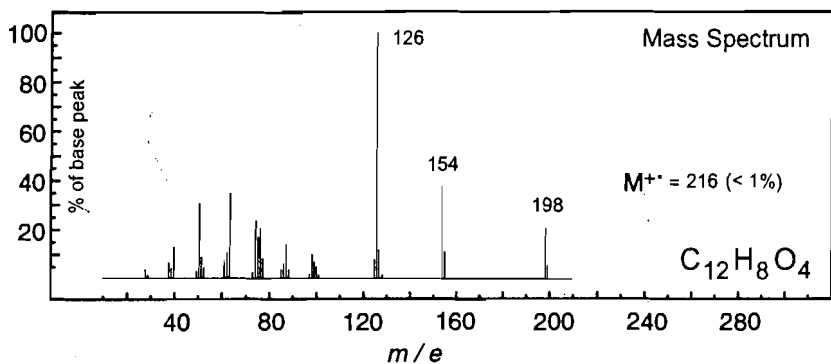
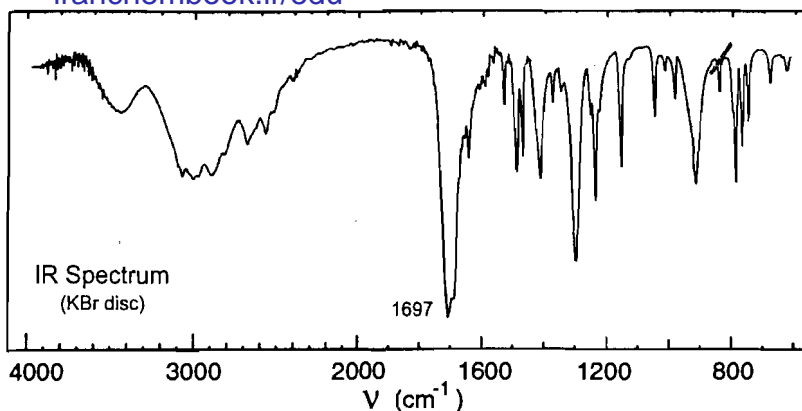

## UV Spectrum

 $\lambda_{\text{max}} 334 \text{ nm} (\log_{10} \epsilon 3.2)$ 
 $\lambda_{\text{max}} 279 \text{ nm} (\log_{10} \epsilon 3.7)$ 
 $\lambda_{\text{max}} 270 \text{ nm} (\log_{10} \epsilon 3.7)$ 
 $\lambda_{\text{max}} 236 \text{ nm} (\log_{10} \epsilon 4.8)$ 

solvent : methanol

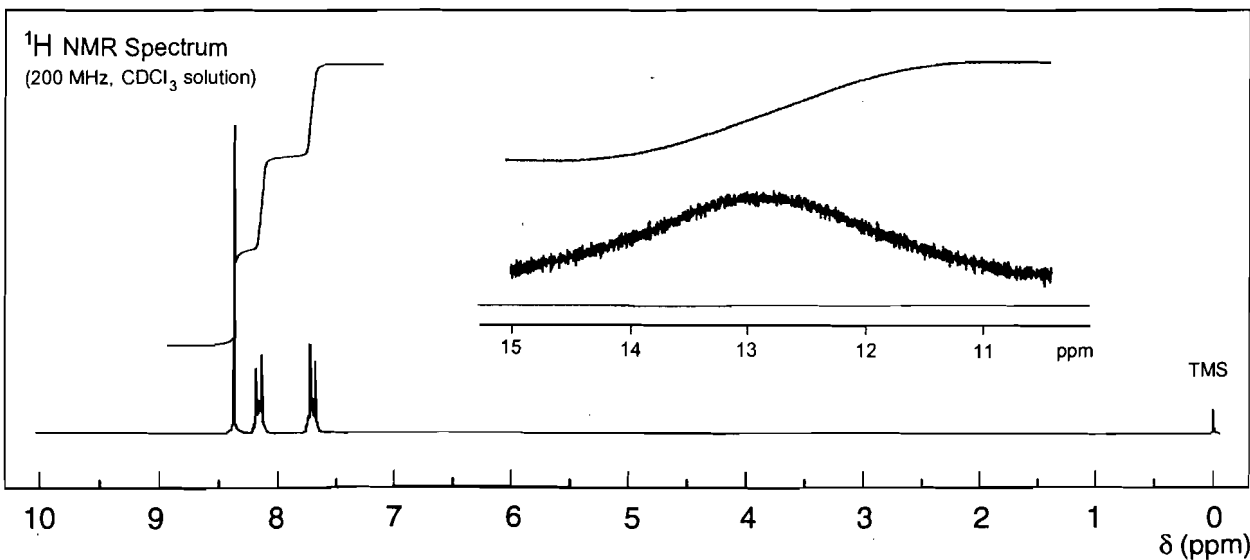
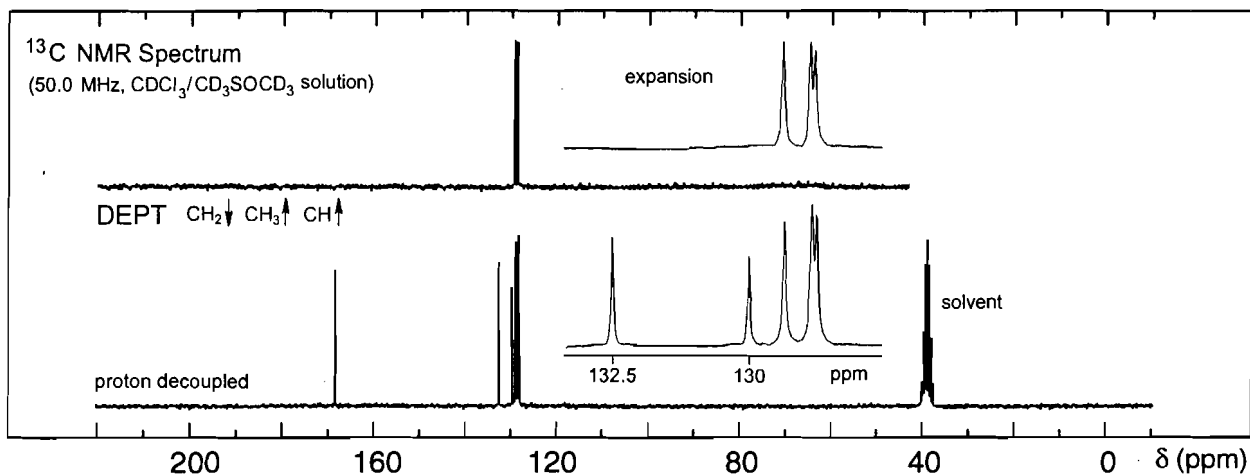

## Problem 274a

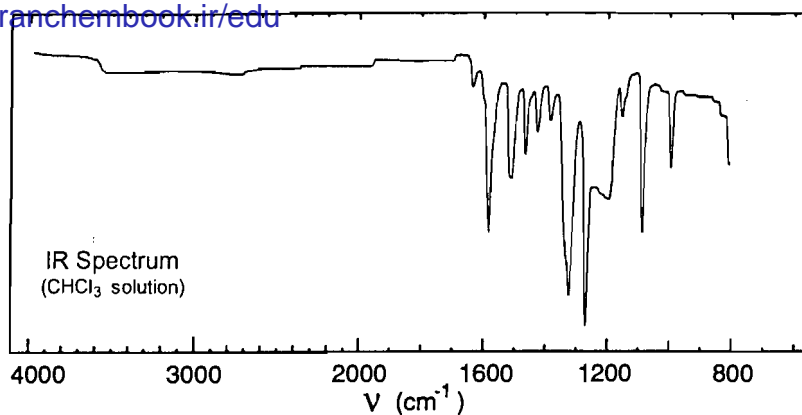

A 400 MHz <sup>1</sup>H NMR spectrum (with expansions and decouplings) is given on the following page

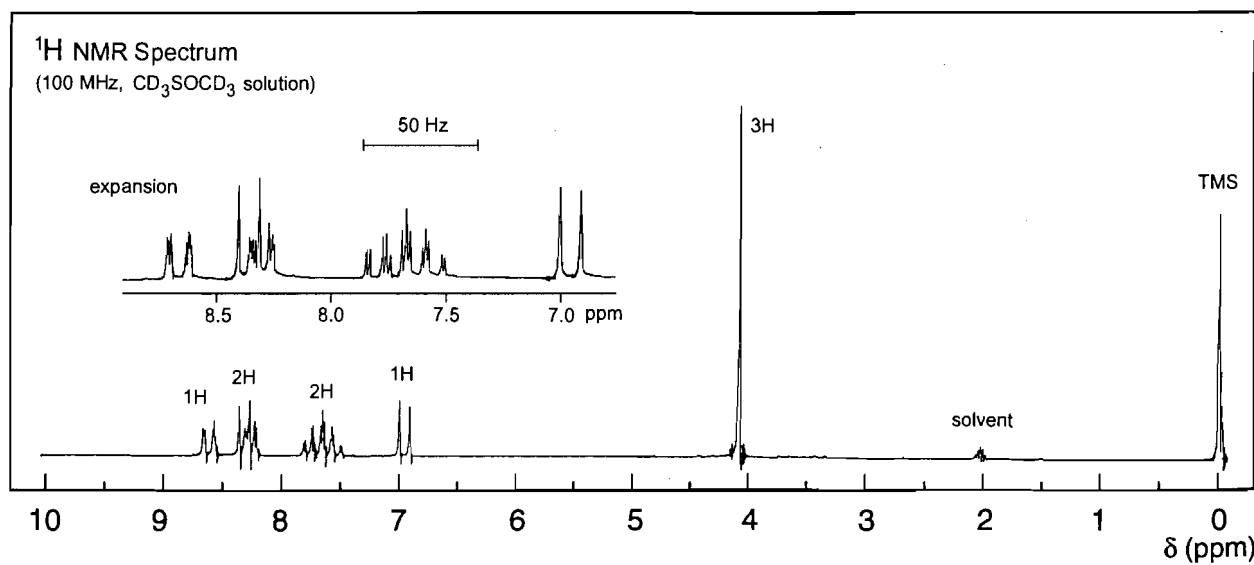
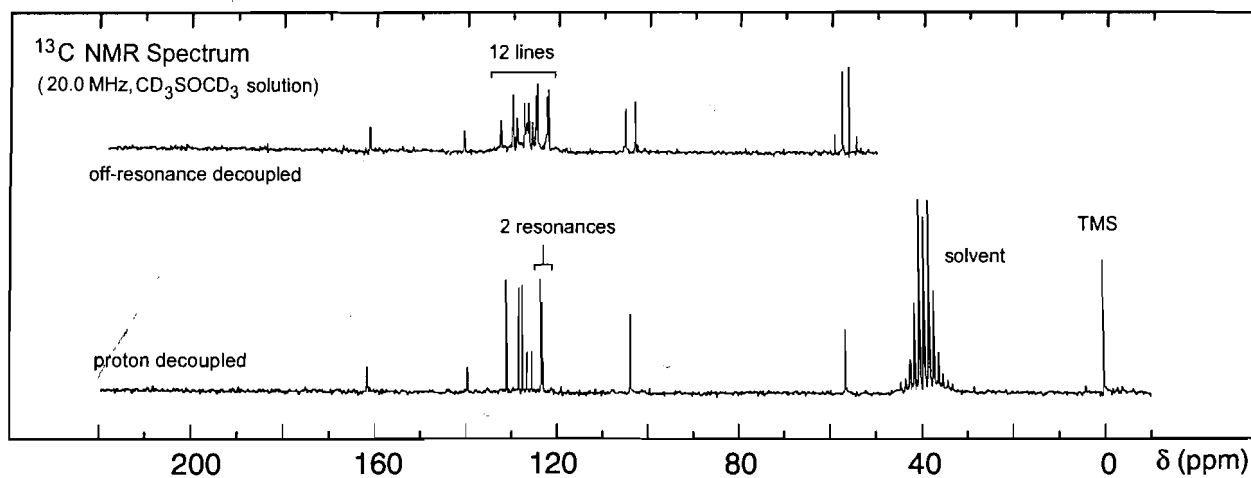
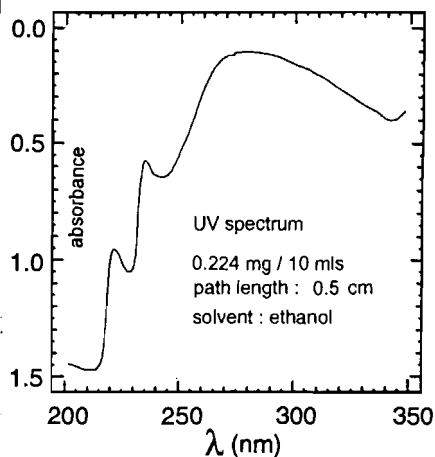
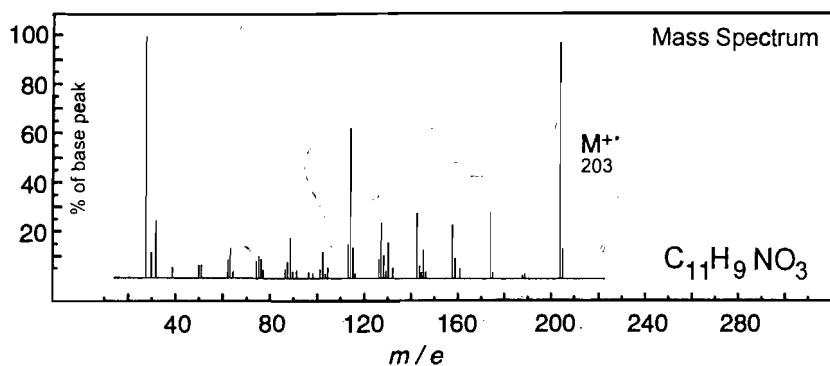

$^1\text{H}$  NMR Spectrum  
(400 MHz,  $\text{CDCl}_3$  solution)  
Aromatic region only

Note: Irradiation of the signal at  $\delta$  4.05 in the  $^1\text{H}$  NMR produces an enhancement of the signals at  $\delta$  7.00 and 8.29 ppm via the NOE

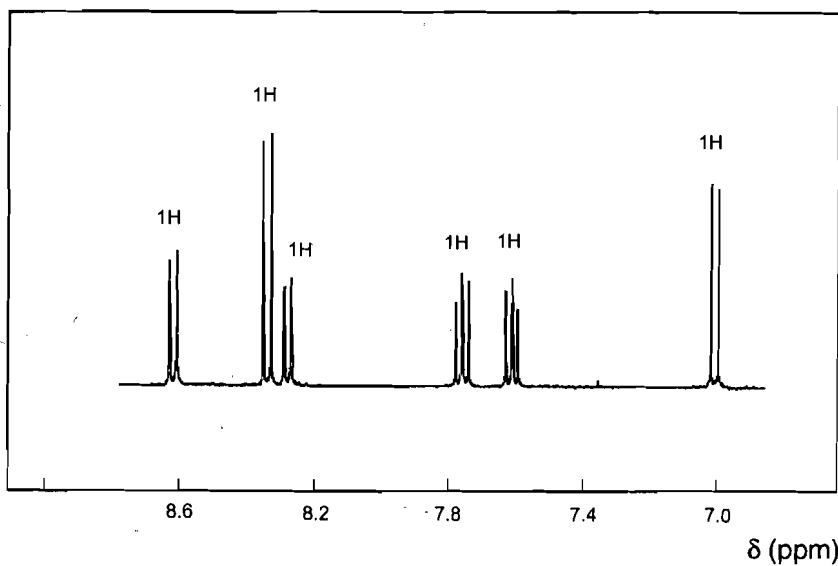

Expansion of regions  
of the 400 MHz NMR spectrum

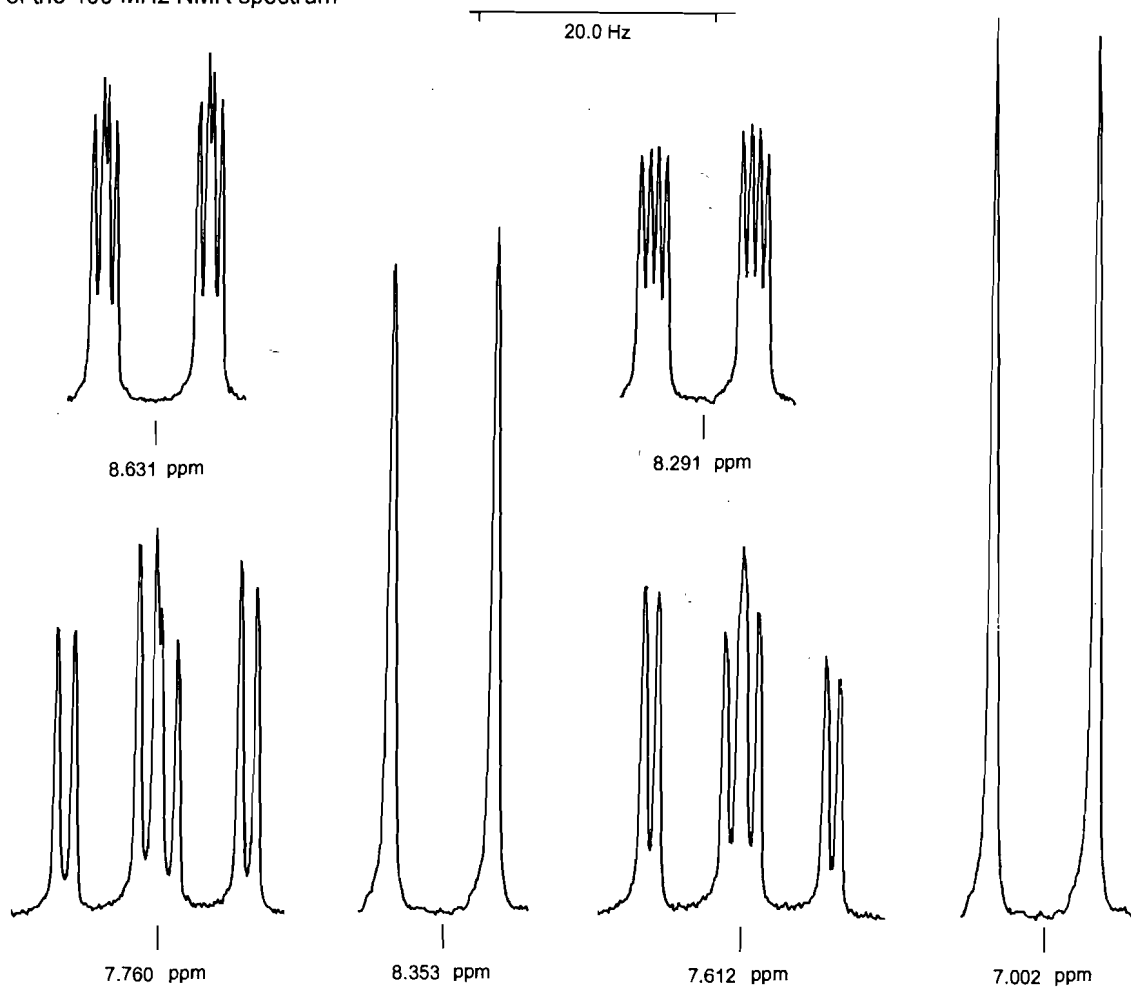

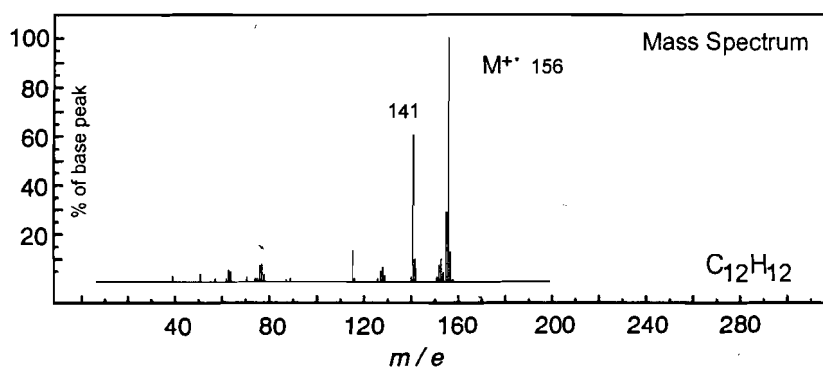
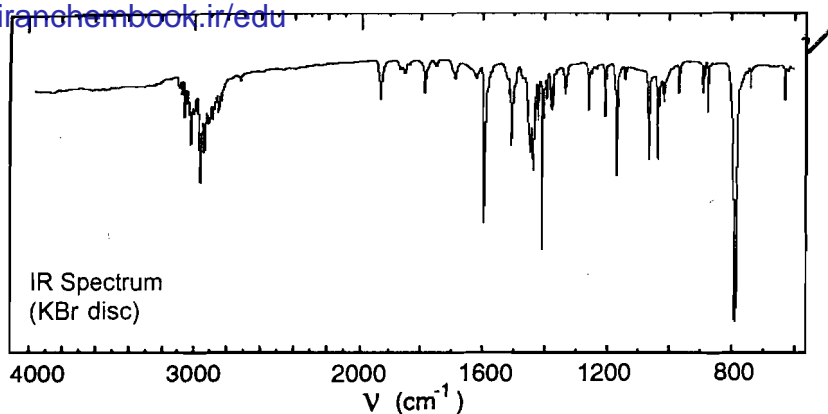

## UV Spectrum

$$\lambda_{\max} 225 \text{ nm } (\log_{10} \epsilon 5.2)$$

$$\lambda_{\max} 266 \text{ nm } (\log_{10} \epsilon 3.6)$$

$$\lambda_{\max} 276 \text{ nm } (\log_{10} \epsilon 3.9)$$

$$\lambda_{\max} 285 \text{ nm } (\log_{10} \epsilon 4.0)$$

$$\lambda_{\max} 297 \text{ nm } (\log_{10} \epsilon 3.8)$$

solvent : methanol

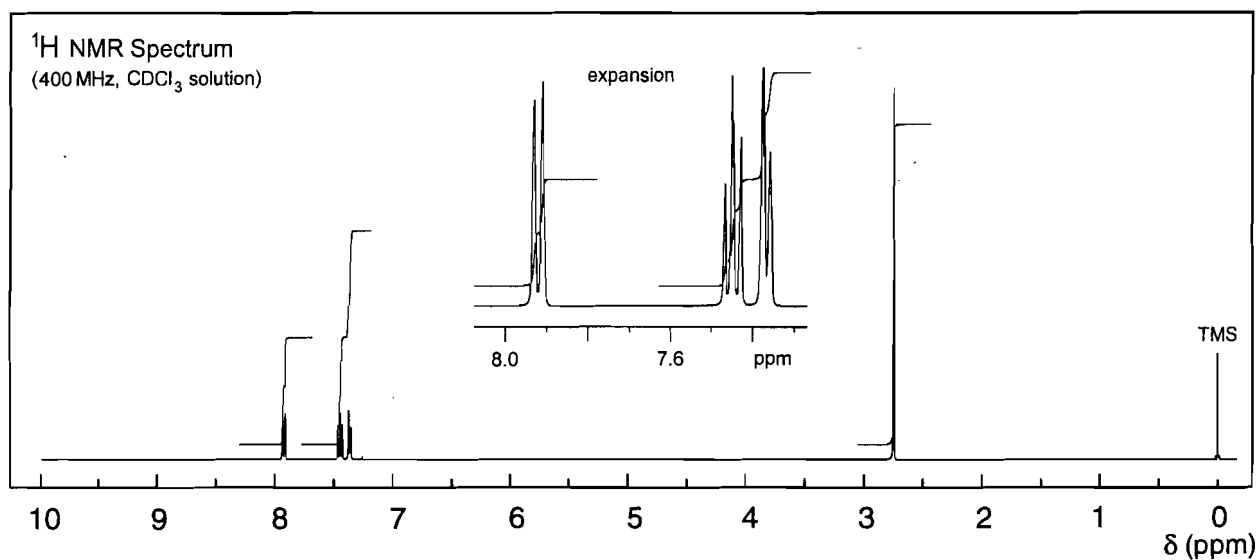
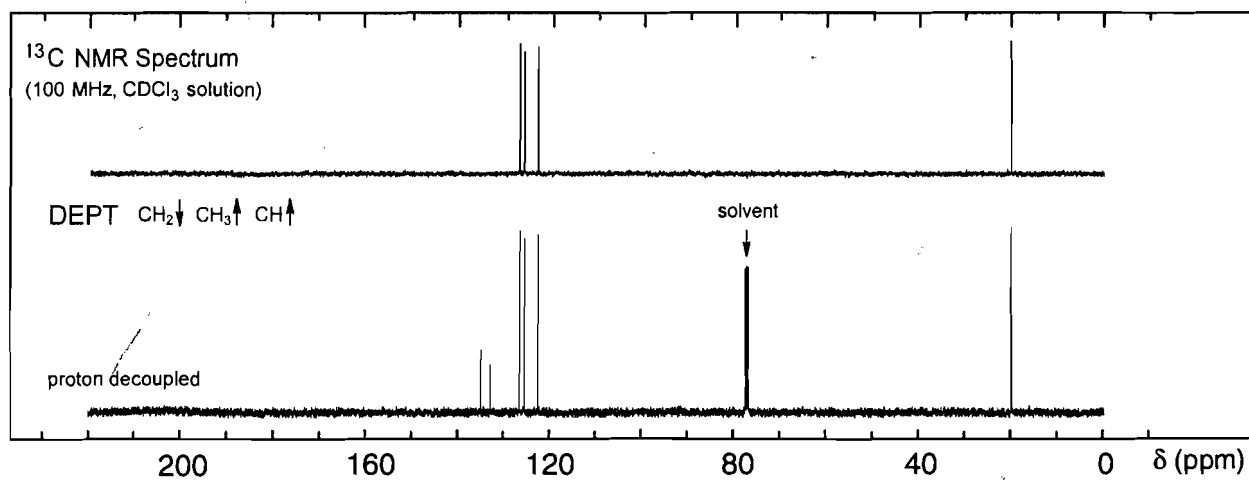

## Problem 276

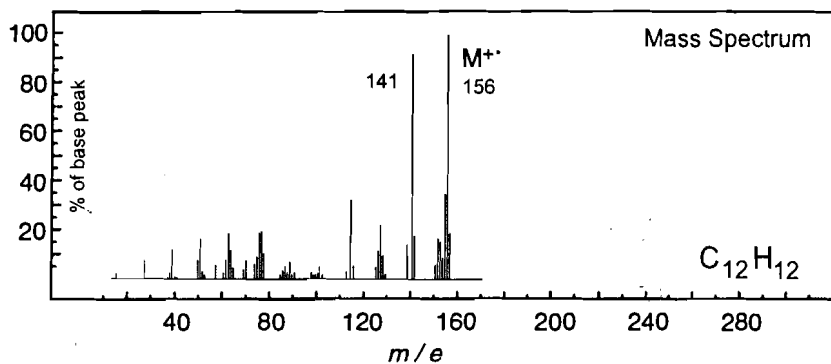
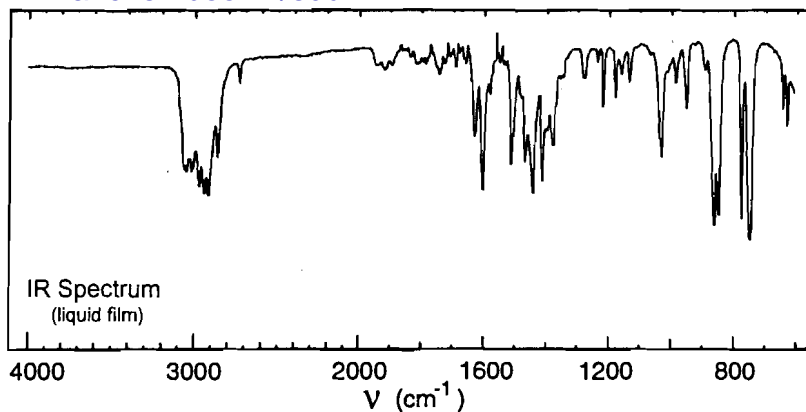

UV Spectrum

 $\lambda_{\max}$  321 nm ( $\log_{10} \epsilon$  2.6) $\lambda_{\max}$  281 nm ( $\log_{10} \epsilon$  3.7)

solvent: ethanol

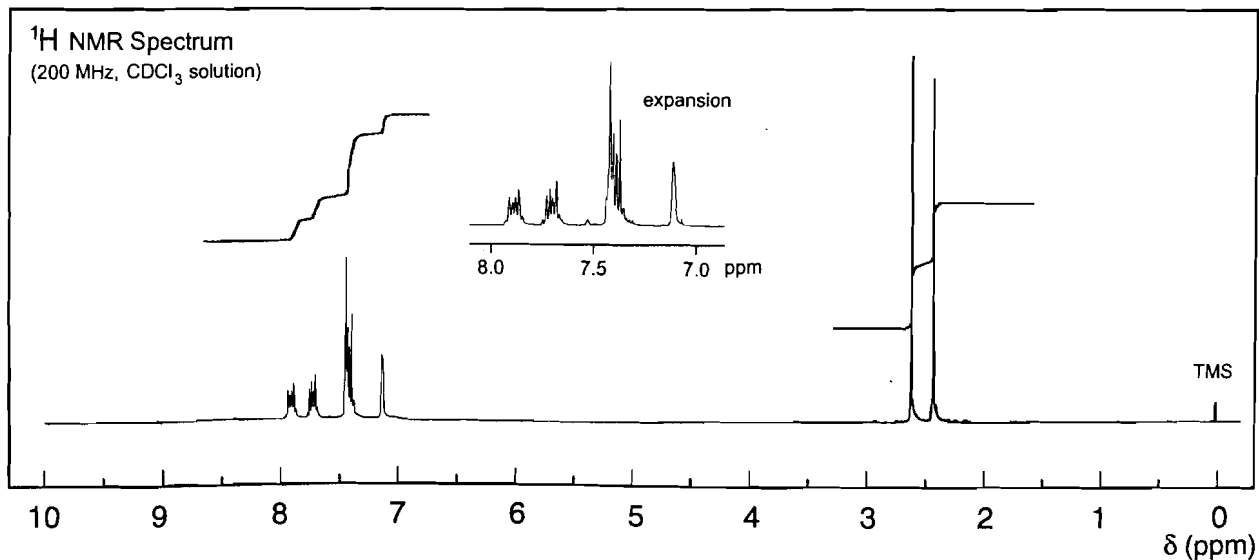
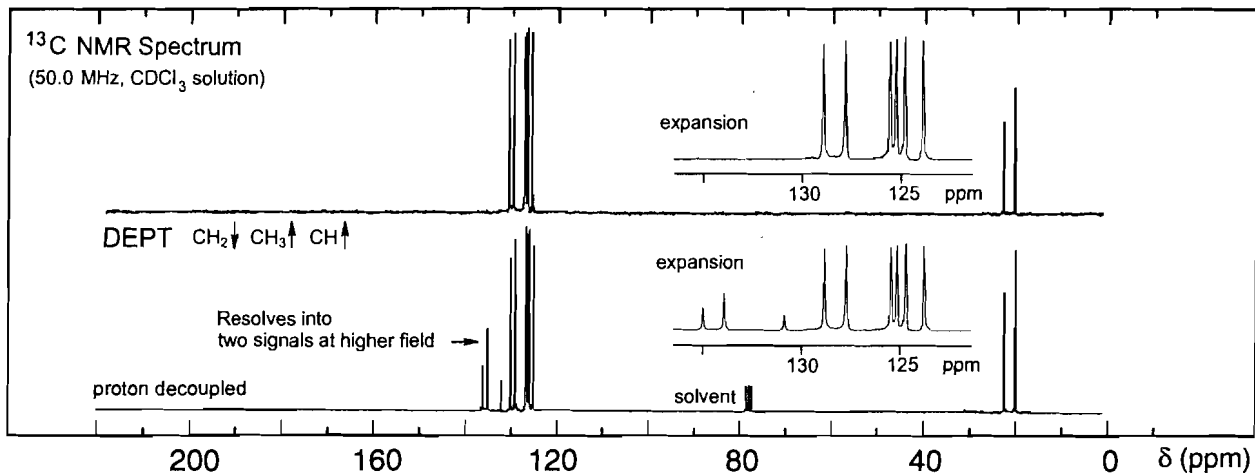



## Problem 277

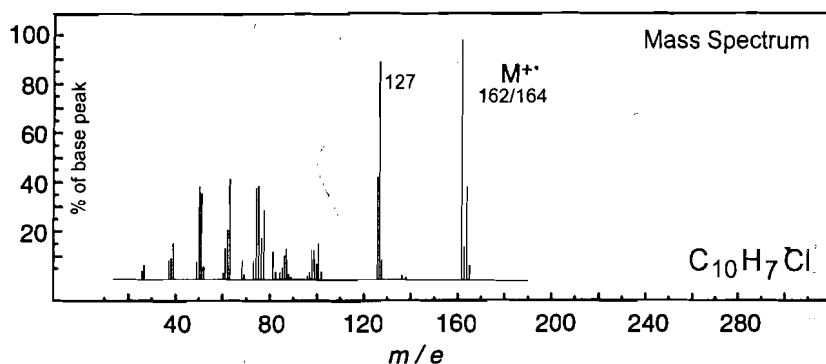
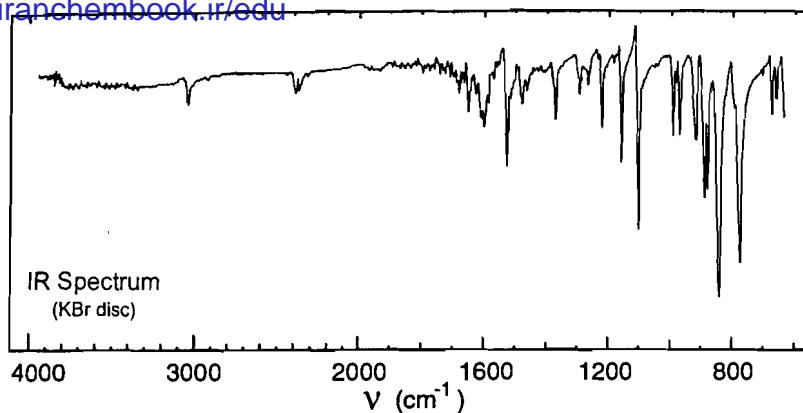

## UV Spectrum

 $\lambda_{\text{max}}$  311 nm ( $\log_{10} \epsilon$  2.6)

 $\lambda_{\text{max}}$  289 nm ( $\log_{10} \epsilon$  3.7)

 $\lambda_{\text{max}}$  225 nm ( $\log_{10} \epsilon$  5.0)

solvent : methanol

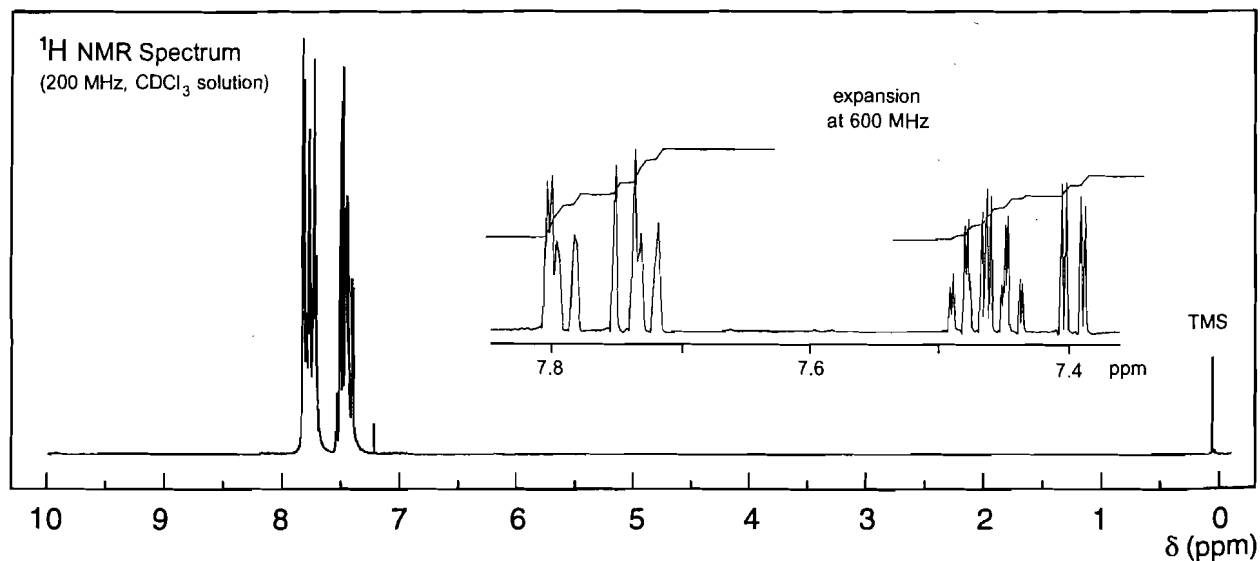
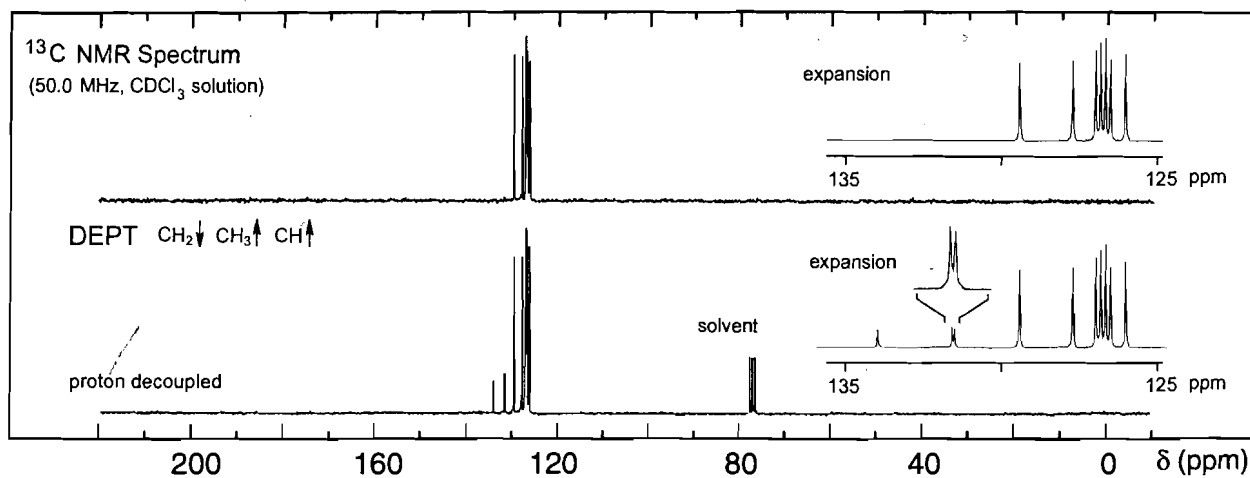

---

## Problem 278

An organic compound has the molecular formula  $C_{10}H_{14}$ . Identify the compound using the spectroscopic data given below.

$\nu_{\max}$  (liquid film): no significant features in the infrared spectrum.

$\lambda_{\max}$ : 265 (log  $\epsilon$ : 2.3) nm.  $^1H$  NMR ( $CDCl_3$  solution):  $\delta$  7.1, m, 5H; 2.5, apparent sextet,  $J$  7 Hz, 1H; 1.6, apparent quintet,  $J$  7 Hz, 2H; 1.22, d,  $J$  7 Hz, 3H; 0.81, t,  $J$  7 Hz, 3H ppm.  $^{13}C\{^1H\}$  NMR ( $CDCl_3$  solution):  $\delta$  148.4 (C), 129.3, 127.9, 126.1, 42.3 (CH), 31.7 (CH<sub>2</sub>), 22.2, 12.2 (CH<sub>3</sub>) ppm. Mass spectrum:  $m/e$  134 ( $M^+$ , 20), 119(8), 105(100), 77(10).

---

## Problem 279

An organic compound has the molecular formula  $C_{12}H_{17}NO$ . Identify the compound using the spectroscopic data given below.

$\nu_{\max}$  (KBr disc): 3296m, 1642s  $cm^{-1}$ .  $^1H$  NMR ( $CDCl_3$  solution):  $\delta$  7.23-7.42, m, 5H; 5.74, br s, exch.  $D_2O$ , 1H; 5.14, q,  $J$  6.7 Hz, 1H; 2.15, t,  $J$  7.1 Hz, 2H; 1.66, m, 2H; 1.48, d,  $J$  6.7 Hz, 3H; 0.93, t,  $J$  7.3 Hz, 3H ppm.

$^{13}C\{^1H\}$  NMR ( $CDCl_3$  solution):  $\delta$  172.0 (C), 143.3 (C), 128.6, 127.3, 126.1, 48.5 (CH), 38.8 (CH<sub>2</sub>), 21.7 (CH<sub>3</sub>), 19.1 (CH<sub>2</sub>), 13.7 (CH<sub>3</sub>) ppm.

Mass spectrum:  $m/e$  191( $M^+$ , 40), 120(33), 105(58), 104(100), 77(18), 43(46).

---

## Problem 280

An organic compound has the molecular formula  $C_{16}H_{30}O_4$ . Identify the compound using the spectroscopic data given below.

$\nu_{\max}$  ( $CHCl_3$  solution):  $1733\text{ cm}^{-1}$ .  $^1H$  NMR ( $CDCl_3$  solution):  $\delta$  4.19, q,  $J$  7.2 Hz, 4H; 3.35, s, 1H; 1.20, t,  $J$  7.2 Hz, 6H; 1.25-1.29, m, 10H; 1.10, s, 6H; 0.88, t,  $J$  6.8 Hz, 3H ppm.  $^{13}C\{^1H\}$  NMR ( $CDCl_3$  solution):  $\delta$  168.5 (C), 60.8 ( $CH_2$ ), 59.6 (CH), 41.1 ( $CH_2$ ), 36.3 (C), 31.8 ( $CH_2$ ), 29.9 ( $CH_2$ ), 25.1 ( $CH_3$ ), 23.6 ( $CH_2$ ), 22.6 ( $CH_2$ ), 14.1 ( $CH_3$ ), 14.0 ( $CH_3$ ) ppm. Mass spectrum:  $m/e$  286 ( $M^+$ , 70), 241(25), 201(38), 160(100), 115(53).

---

## Problem 281

An organic compound has the molecular formula  $C_8H_{13}NO_3$ . Identify the compound using the spectroscopic data given below.

$\nu_{\max}$  (nujol mull):  $1690\text{-}1725\text{ cm}^{-1}$ .  $\lambda_{\max}$ : no significant features in the ultraviolet spectrum.  $^1H$  NMR ( $CDCl_3$  solution):  $\delta$  4.25, q,  $J$  6.7 Hz, 2H; 3.8, t,  $J$  7 Hz, 4H; 2.45, t,  $J$  7 Hz, 4H; 1.3, t,  $J$  6.7 Hz, 3H ppm.  $^{13}C\{^1H\}$  NMR ( $CDCl_3$  solution):  $\delta$  207 (C); 155 (C); 62 ( $CH_2$ ); 43 ( $CH_2$ ); 41 ( $CH_2$ ); 15 ( $CH_3$ ) ppm. Mass spectrum:  $m/e$  171 ( $M^+$ , 15), 142(25), 56(68), 42(100).

---

## Problem 282

An organic compound has the molecular formula  $C_{12}H_{13}NO_3$ . Identify the compound using the spectroscopic data given below.

$\nu_{\max}$  (nujol mull): 3338, 1715, 1592  $cm^{-1}$ .  $\lambda_{\max}$ : 254 (log  $\epsilon$ : 4.3) nm.  $^1H$  NMR (DMSO- $d_6$  solution):  $\delta$  12.7, broad s, exch.  $D_2O$ , 1H; 8.42, d,  $J$  6.1 Hz, 1H; 7.45-7.25, m, 5H; 6.63 dd,  $J$  15.9, 1.2 Hz, 1H; 6.30, dd,  $J$  15.9, 6.7 Hz, 1H; 4.93 ddd,  $J$  6.7, 6.1, 1.2 Hz, 1H; 1.90, s, 3H ppm.  $^{13}C\{^1H\}$  NMR (DMSO- $d_6$  solution):  $\delta$  171.9 (C), 169.0 (C), 135.9 (C), 131.7 (CH), 128.7 (CH), 127.9 (CH), 126.3 (CH), 124.6 (CH), 54.4 (CH), 22.3 ( $CH_3$ ) ppm. Mass spectrum:  $m/e$  219 ( $M^+$ , 25), 175(10), 132(100), 131(94), 103(35), 77(46), 43(83).

---

## Problem 283

An organic compound has the molecular formula  $C_{13}H_{16}O_4$ . Identify the compound using the spectroscopic data given below.

$\nu_{\max}$  (KBr disc): 3479s, 1670s,  $cm^{-1}$ .  $\lambda_{\max}$ : 250 (log  $\epsilon$ : 4) nm.  $^1H$  NMR ( $CDCl_3$  solution):  $\delta$  1.40, s, 3H; 2.00, bs exch., 1H; 2.71, d,  $J$  15.7 Hz, 1H; 2.77, d,  $J$  15.7 Hz, 1H; 2.91, d,  $J$  17.8 Hz, 1H; 3.14, d,  $J$  17.8 Hz, 1H; 3.79, s, 3H; 3.84, s, 3H; 6.80, d,  $J$  9.0 Hz, 1H; 6.98, d,  $J$  9.0 Hz, 1H ppm.  $^{13}C\{^1H\}$  NMR ( $CDCl_3$  solution):  $\delta$  196.0 (C); 154.0 (C); 157.7 (C); 131.5 (C); 122.0 (C); 116.0 (CH); 110.5 (CH); 70.8 (C); 56.3 ( $CH_3$ ); 55.9 ( $CH_3$ ); 54.1 ( $CH_2$ ); 37.7 ( $CH_2$ ); 29.2 ( $CH_3$ ) ppm. Mass spectrum:  $m/e$  236 ( $M^+$ , 87), 218(33), 178(100), 163(65).



## 9.2

# THE ANALYSIS OF MIXTURES

---

## Problem 284

A 400 MHz  $^1\text{H}$  NMR spectrum of a mixture of ethanol ( $\text{C}_2\text{H}_6\text{O}$ )  $\delta$  1.24,  $\delta$  1.78,  $\delta$  3.72 and bromoethane ( $\text{C}_2\text{H}_5\text{Br}$ )  $\delta$  1.68 and  $\delta$  3.44 is given below. Estimate the relative proportions (mole %) of the 2 components from the integrals in the spectrum.

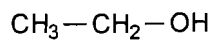

ethanol

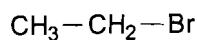

bromoethane

$^1\text{H}$  NMR Spectrum  
(400 MHz,  $\text{CDCl}_3$  solution)

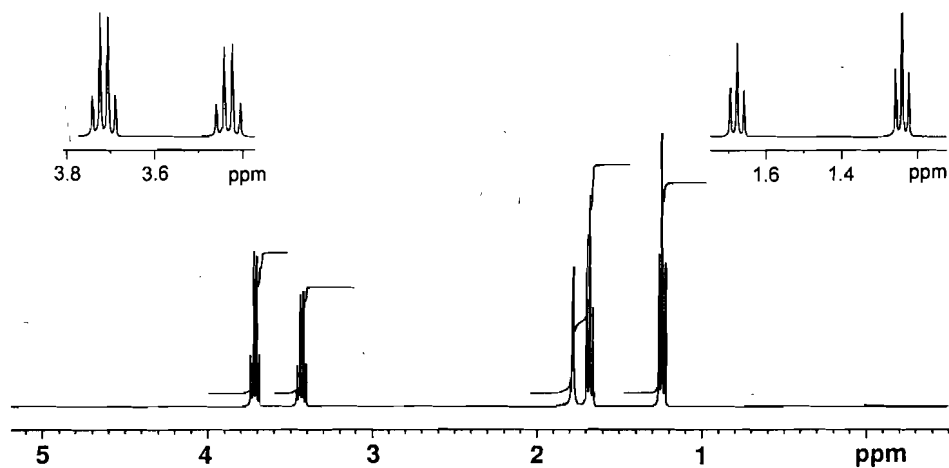

Compound	Mole %
ethanol	
bromoethane	

## Problem 285

A 400 MHz  $^1\text{H}$  NMR spectrum of a mixture of common organic solvents consisting of benzene ( $\text{C}_6\text{H}_6$ )  $\delta$  7.37; diethyl ether ( $\text{C}_4\text{H}_{10}\text{O}$ )  $\delta$  3.49 and  $\delta$  1.22; and dichloromethane ( $\text{CH}_2\text{Cl}_2$ )  $\delta$  5.30 is given below. Estimate the relative proportions (mole %) of the 3 components from the integrals in the spectrum.



benzene

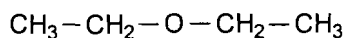

diethyl ether

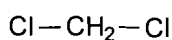

dichloromethane

$^1\text{H}$  NMR Spectrum  
(400 MHz,  $\text{CDCl}_3$  solution)

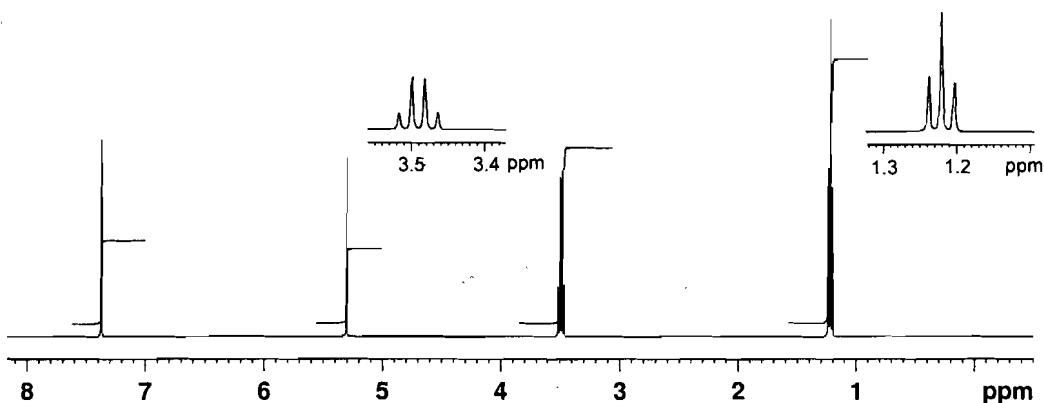

Compound	Mole %
benzene	
diethyl ether	
dichloromethane	



## Problem 286

A 400 MHz  $^1\text{H}$  NMR spectrum of a mixture of benzene ( $\text{C}_6\text{H}_6$ )  $\delta$  7.37, ethyl acetate ( $\text{C}_4\text{H}_8\text{O}_2$ )  $\delta$  4.13,  $\delta$  2.05,  $\delta$  1.26 and dioxane ( $\text{C}_4\text{H}_8\text{O}_2$ )  $\delta$  3.70 is given below. Estimate the relative proportions (mole %) of the 3 components from the integrals in the spectrum.



benzene

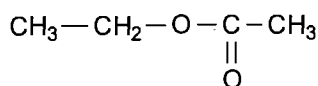

ethyl acetate

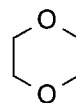

dioxane

$^1\text{H}$  NMR Spectrum  
(400 MHz,  $\text{CDCl}_3$  solution)

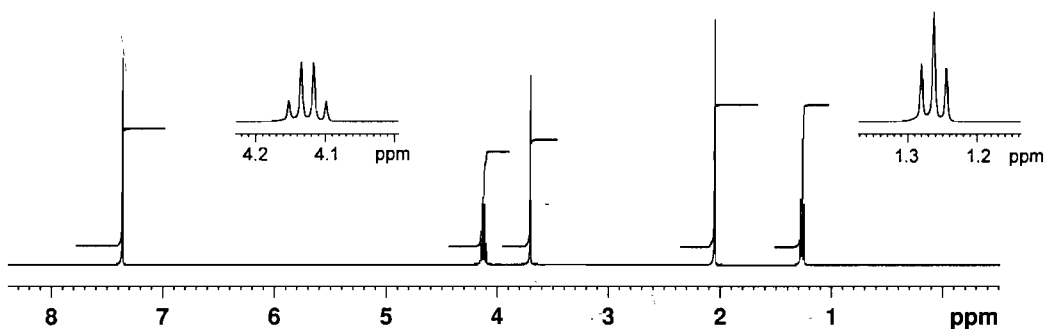

Compound	Mole %
benzene	
ethyl acetate	
dioxane	

## Problem 287

A 100 MHz  $^{13}\text{C}$  NMR spectrum of a mixture of ethanol ( $\text{C}_2\text{H}_6\text{O}$ )  $\delta$  18.3 ( $\text{CH}_3$ ),  $\delta$  57.8 ( $\text{CH}_2$ ) and bromoethane ( $\text{C}_2\text{H}_5\text{Br}$ )  $\delta$  19.5 ( $\text{CH}_3$ ) and  $\delta$  27.9 ( $\text{CH}_2$ ) in  $\text{CDCl}_3$  solution is given below. The spectrum was recorded with a long relaxation delay (300 seconds) between acquisitions and with the NOE suppressed. Estimate the relative proportions (mole %) of the 2 components from the peak intensities in the spectrum.

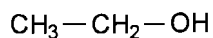

ethanol

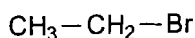

bromoethane

$^{13}\text{C}$  NMR Spectrum  
(100 MHz,  $\text{CDCl}_3$  solution)

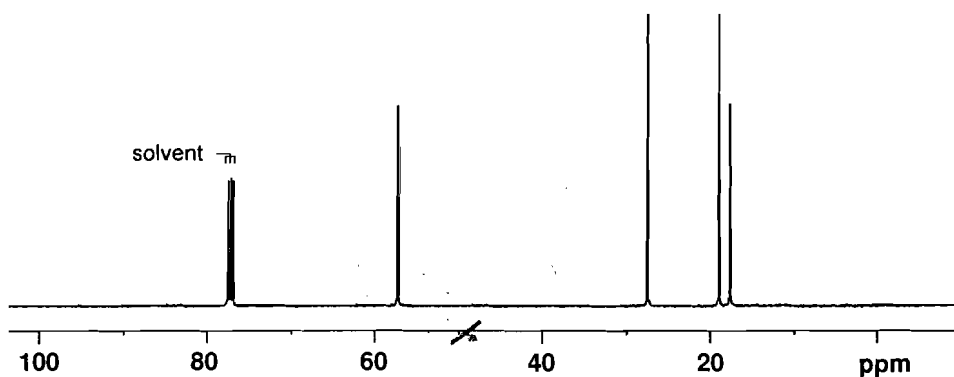

Compound	Mole %
ethanol	
bromoethane	

## Problem 288

A 100 MHz  $^{13}\text{C}$  NMR spectrum of a mixture of benzene ( $\text{C}_6\text{H}_6$ )  $\delta$  128.7 (CH), diethyl ether ( $\text{C}_4\text{H}_{10}\text{O}$ )  $\delta$  67.4 ( $\text{CH}_2$ ) and  $\delta$  17.1 ( $\text{CH}_3$ ) and dichloromethane ( $\text{CH}_2\text{Cl}_2$ )  $\delta$  53.7 in  $\text{CDCl}_3$  solution is given below. The spectrum was recorded with a long relaxation delay (300 seconds) between acquisitions and with the NOE suppressed. Estimate the relative proportions (mole %) of the 3 components from the peak intensities in the spectrum.



benzene

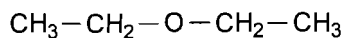

diethyl ether



dichloromethane

$^{13}\text{C}$  NMR Spectrum  
(100 MHz,  $\text{CDCl}_3$  solution)

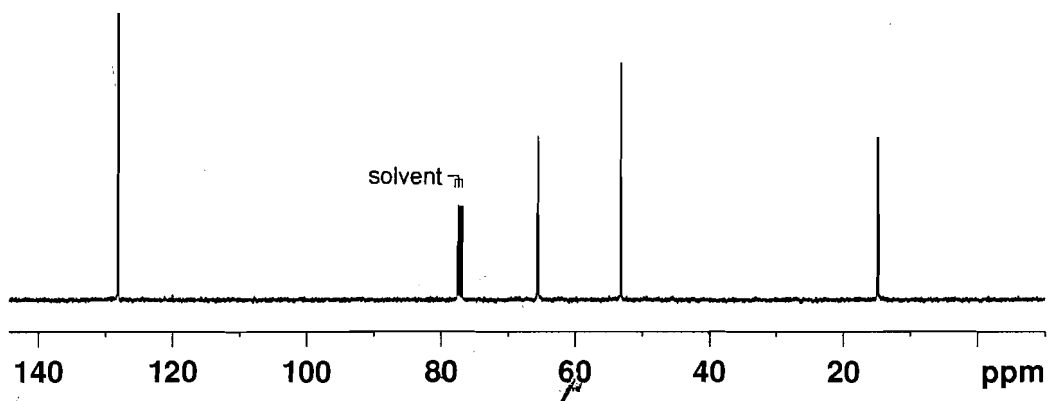

Compound	Mole %
benzene	
diethyl ether	
dichloromethane	

## Problem 289

A 100 MHz  $^{13}\text{C}$  NMR spectrum of a mixture of benzene ( $\text{C}_6\text{H}_6$ )  $\delta$  128.7 (CH), ethyl acetate ( $\text{CH}_3\text{CH}_2\text{OCOCH}_3$ )  $\delta$  170.4 (C=O),  $\delta$  60.1 ( $\text{CH}_2$ ),  $\delta$  20.1 ( $\text{CH}_3$ ),  $\delta$  14.3 ( $\text{CH}_3$ ) and dioxane ( $\text{C}_4\text{H}_8\text{O}_2$ )  $\delta$  66.3 ( $\text{CH}_2$ ) in  $\text{CDCl}_3$  solution is given below. The spectrum was recorded with a long relaxation delay (300 seconds) between acquisitions and with the NOE suppressed. Estimate the relative proportions (mole %) of the 3 components from the peak intensities in the spectrum.



benzene

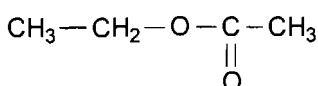

ethyl acetate

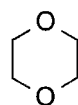

dioxane

$^{13}\text{C}$  NMR Spectrum  
(100 MHz,  $\text{CDCl}_3$  solution)

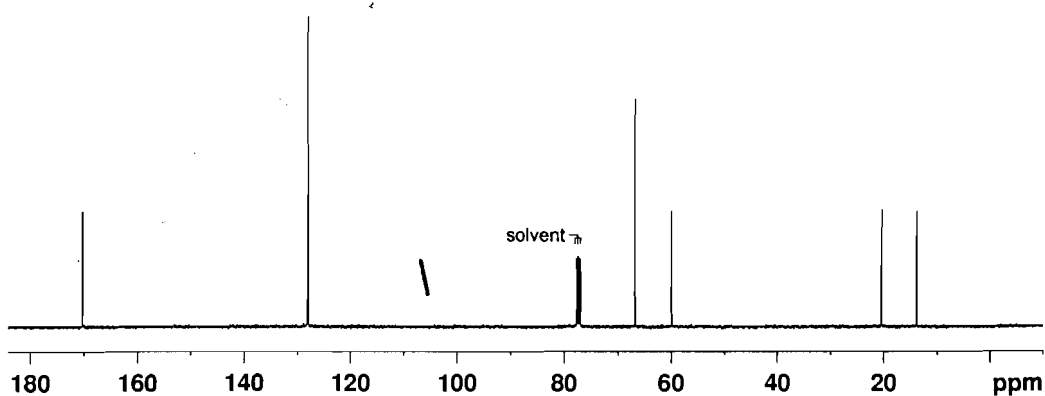

Compound	Mole %
benzene	
ethyl acetate	
dioxane	

## Problem 290

Oxidation of fluorene ( $C_{13}H_{10}$ ) with chromic acid gives fluorenone ( $C_{13}H_8O$ ). If the reaction does not go to completion, then a mixture of the starting material and the product is usually obtained. The  $^1H$  NMR spectrum below is from a partially oxidized sample of fluorene so it contains a mixture of fluorene and fluorenone. Determine the relative amounts (mole %) of fluorene and fluorenone in the mixture.

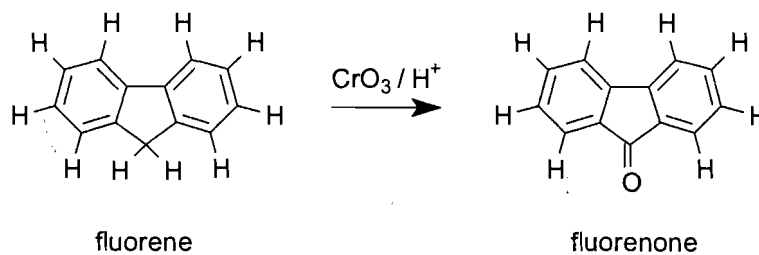

$^1H$  NMR Spectrum  
(300 MHz,  $CDCl_3$  solution)

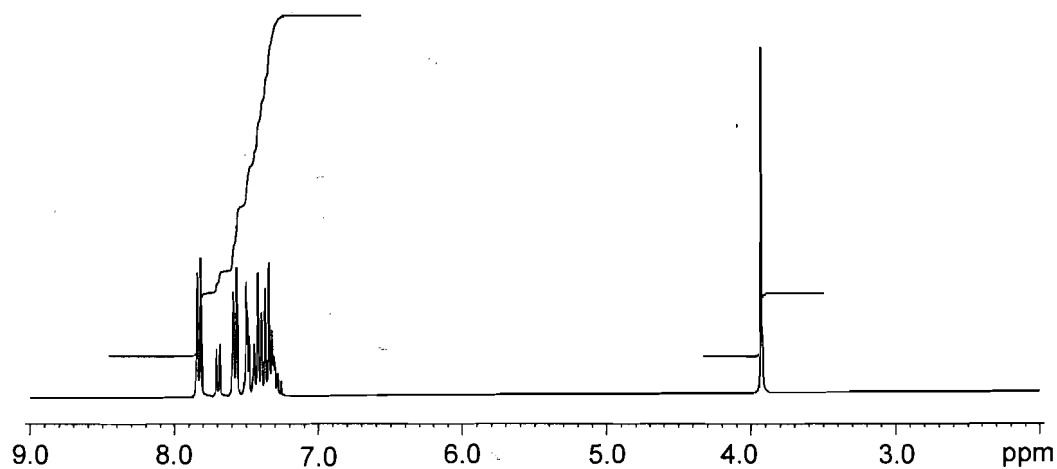

Compound	Mole %
fluorene	
fluorenone	

## Problem 291

Careful nitration of anisole ( $\text{CH}_3\text{OC}_6\text{H}_5$ ) with a new nitrating reagent gives a mixture of 4-nitroanisole and 2-nitroanisole. The section of the  $^1\text{H}$  NMR spectrum below is from the aromatic region of the crude reaction mixture which is a mixture of the 4- and 2-nitroanisoles. Determine the relative amounts of the two products in the reaction mixture from the integrals in the spectrum.

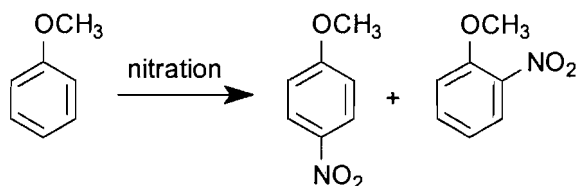

$^1\text{H}$  NMR Spectrum  
(500 MHz,  $\text{CDCl}_3$  solution)

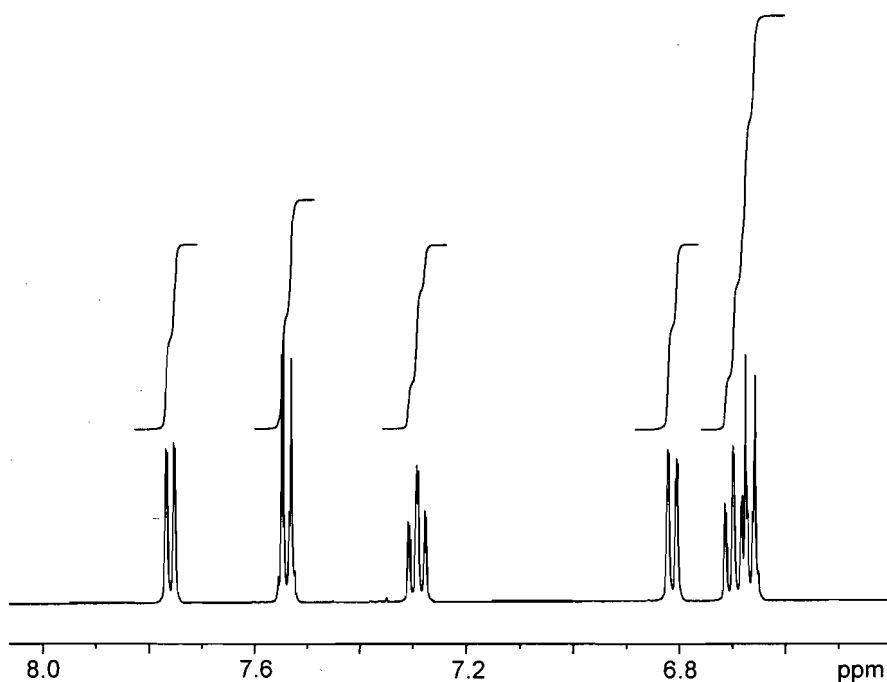

Compound	Mole %
4-nitroanisole	
2-nitroanisole	



## 9.3

### PROBLEMS IN 2-DIMENSIONAL NMR



## Problem 292

The  $^1\text{H}$  and  $^{13}\text{C}$  NMR spectra of 1-propanol ( $\text{C}_3\text{H}_8\text{O}$ ) recorded in  $\text{CDCl}_3$  solution at 298K are given below. The 2-dimensional  $^1\text{H}$ - $^1\text{H}$  COSY spectrum and the C-H correlation spectrum are given on the facing page. From the COSY spectrum, assign the proton spectrum and then use the C-H correlation spectrum to assign the  $^{13}\text{C}$  spectrum *i.e.* determine the chemical shift corresponding to each of the protons and each of the carbons in the molecule.



Proton	Chemical Shift ( $\delta$ ) in ppm	Carbon	Chemical Shift ( $\delta$ ) in ppm
H1		C1	
H2		C2	
H3		C3	
H4			

$^1\text{H}$  NMR Spectrum  
(300 MHz,  $\text{CDCl}_3$  solution)

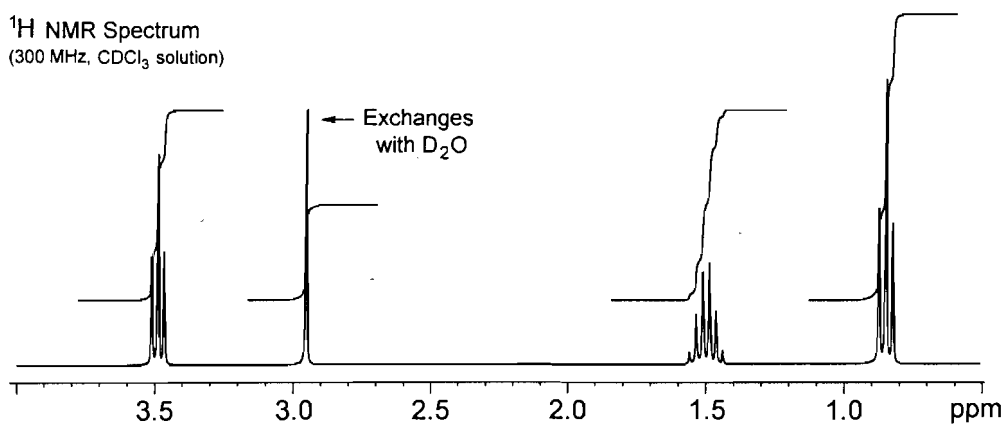

$^{13}\text{C}$  NMR Spectrum  
(75 MHz;  $\text{CDCl}_3$  solution)

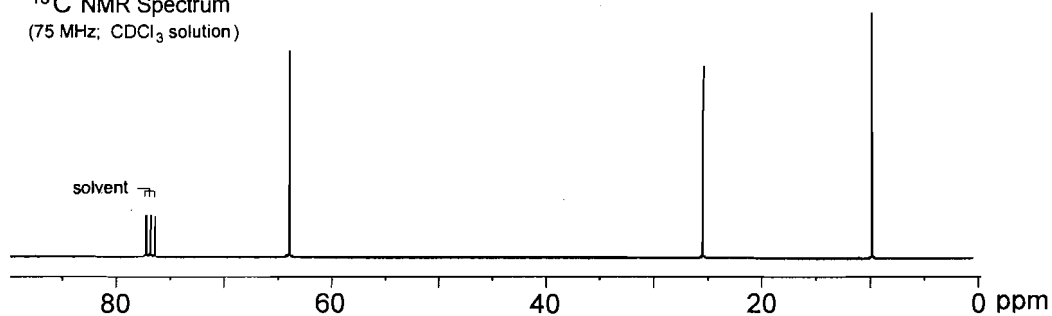

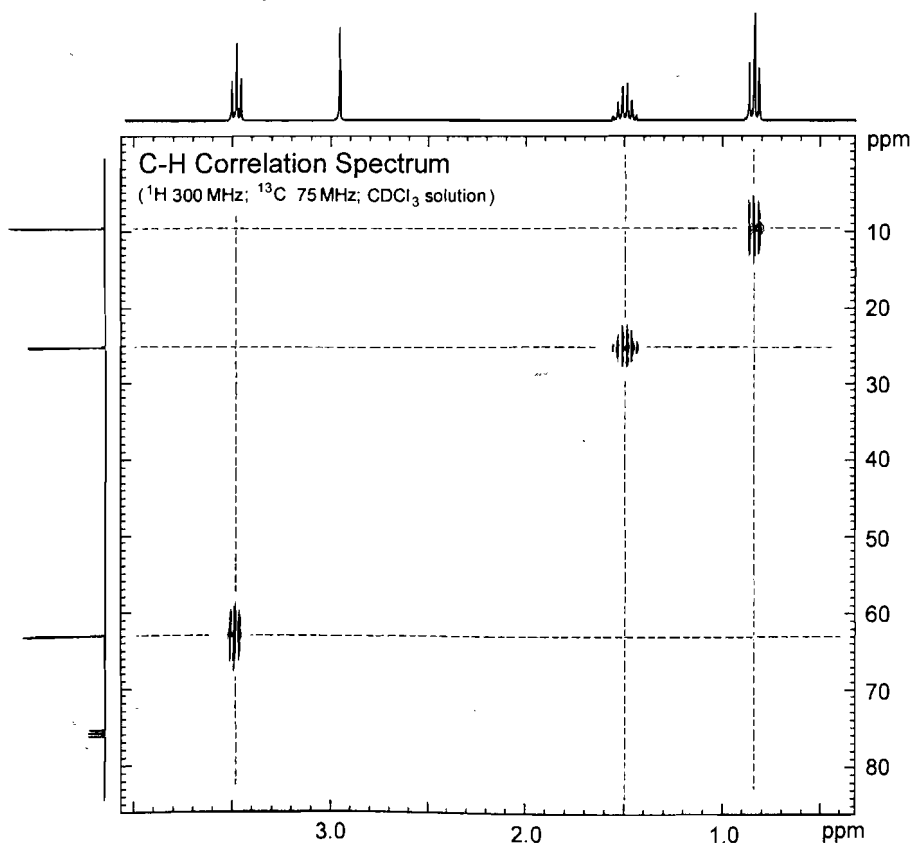
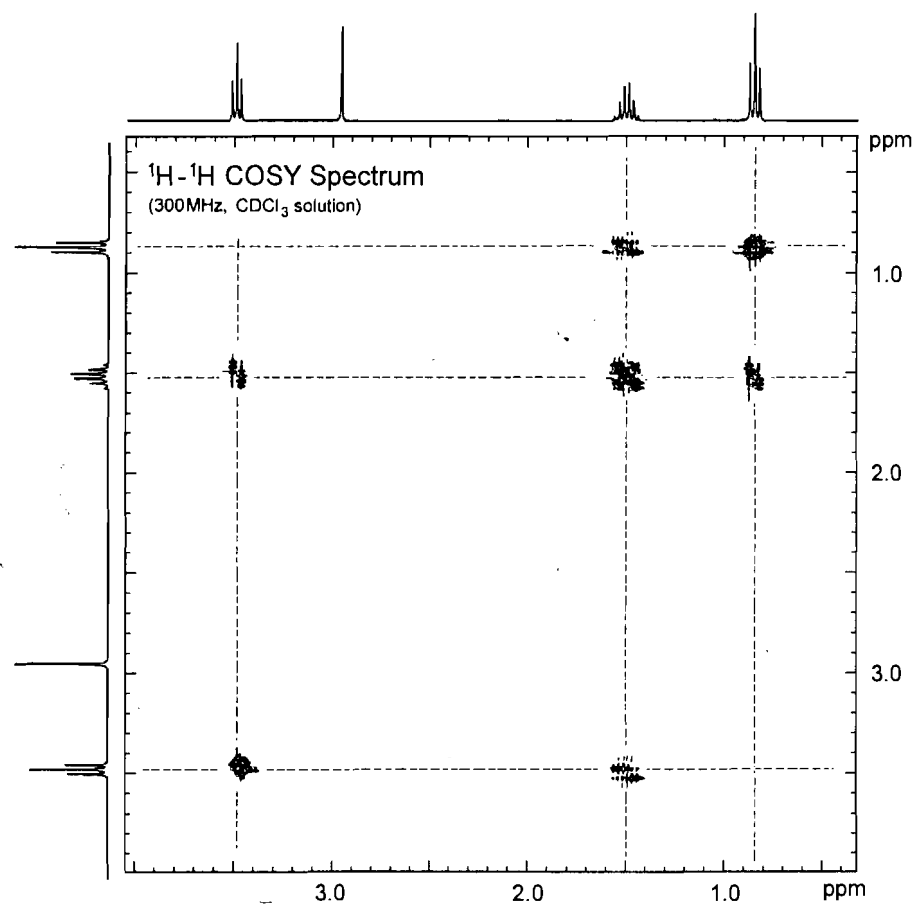

## Problem 293

The  $^1\text{H}$  and  $^{13}\text{C}$  NMR spectra of 1-iodobutane ( $\text{C}_4\text{H}_9\text{I}$ ) recorded in  $\text{CDCl}_3$  solution at 298K are given below. The  $^1\text{H}$  spectrum contains signals at  $\delta$  3.20 (H1), 1.80 (H2), 1.42 (H3) and 0.93 (H4) ppm. The  $^{13}\text{C}$  spectrum contains signals at  $\delta$  6.7 (C1), 35.5 (C2), 23.6 (C3) and 13.0 (C4) ppm. On the facing page produce a schematic diagram of the COSY the C-H correlation spectra for this molecule showing where all of the cross peaks and diagonal peaks would be.

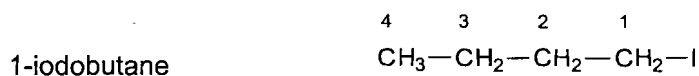

$^1\text{H}$  NMR Spectrum  
(400 MHz,  $\text{CDCl}_3$  solution)

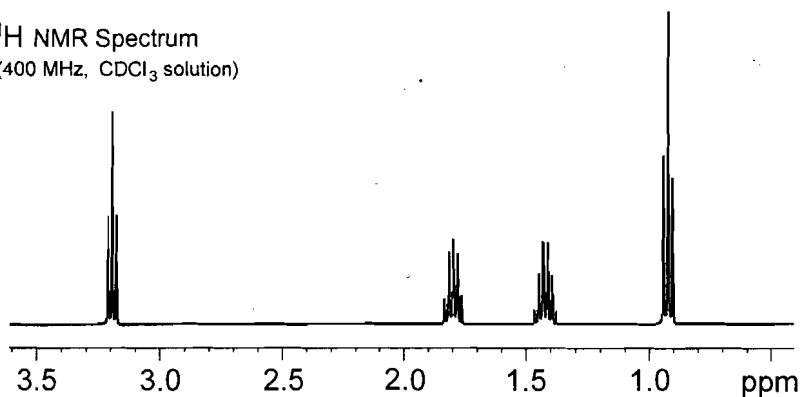

$^{13}\text{C}$  NMR Spectrum  
(100 MHz,  $\text{CDCl}_3$  solution)

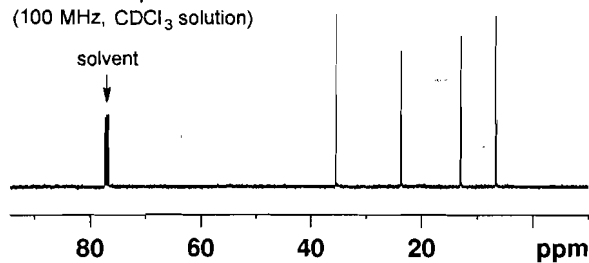

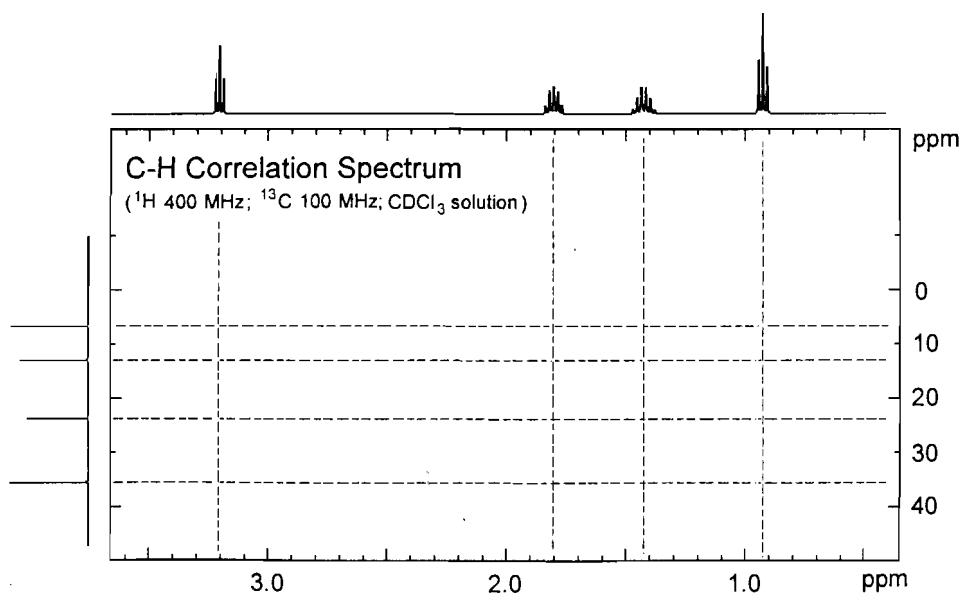
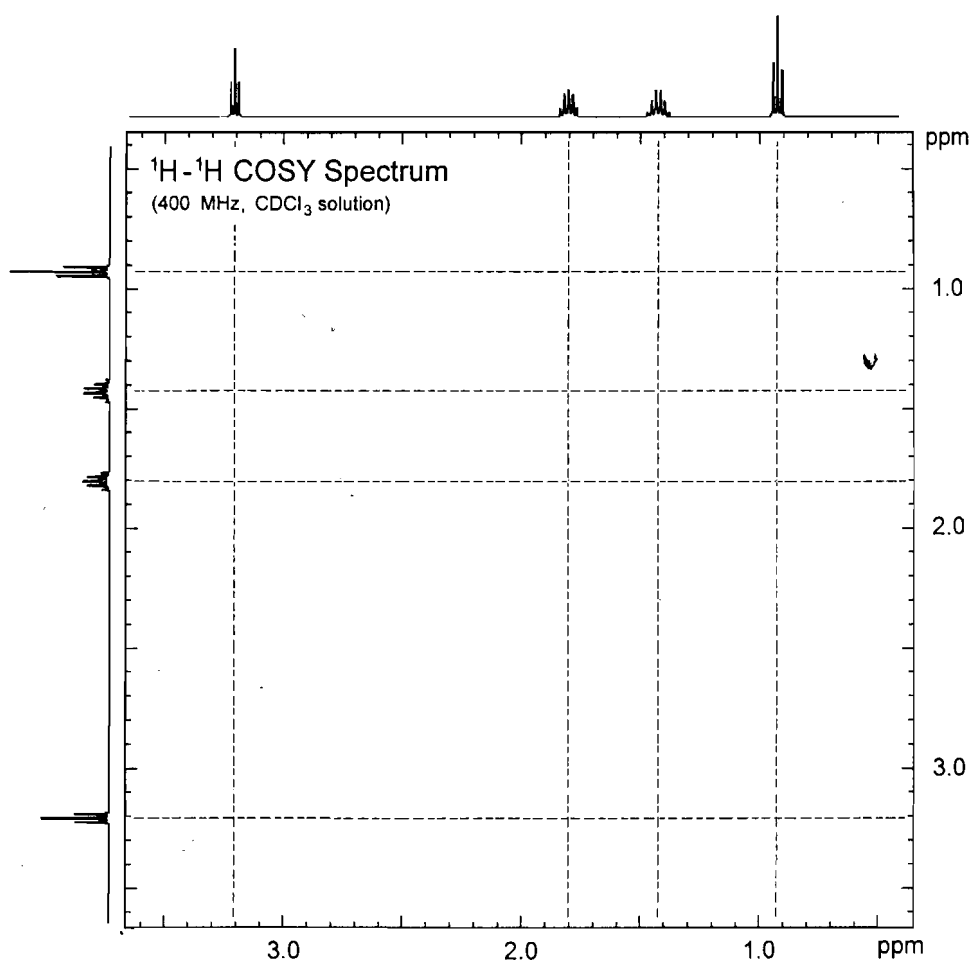

## Problem 294

The  $^1\text{H}$  and  $^{13}\text{C}$  NMR spectra of isobutanol (2-methyl-1-propanol,  $\text{C}_4\text{H}_{10}\text{O}$ ) recorded in  $\text{CDCl}_3$  solution at 298K are given below. The  $^1\text{H}$  spectrum contains signals at  $\delta$  3.28 (H1), 2.98 (OH), 1.68 (H2) and 0.83 (H3) ppm. The  $^{13}\text{C}$  spectrum contains signals at  $\delta$  69.3 (C1), 30.7 (C2) and 18.7 (C3) ppm. On the facing page produce a schematic diagram of the COSY the C-H correlation spectra for this molecule showing where all of the cross peaks and diagonal peaks would be.

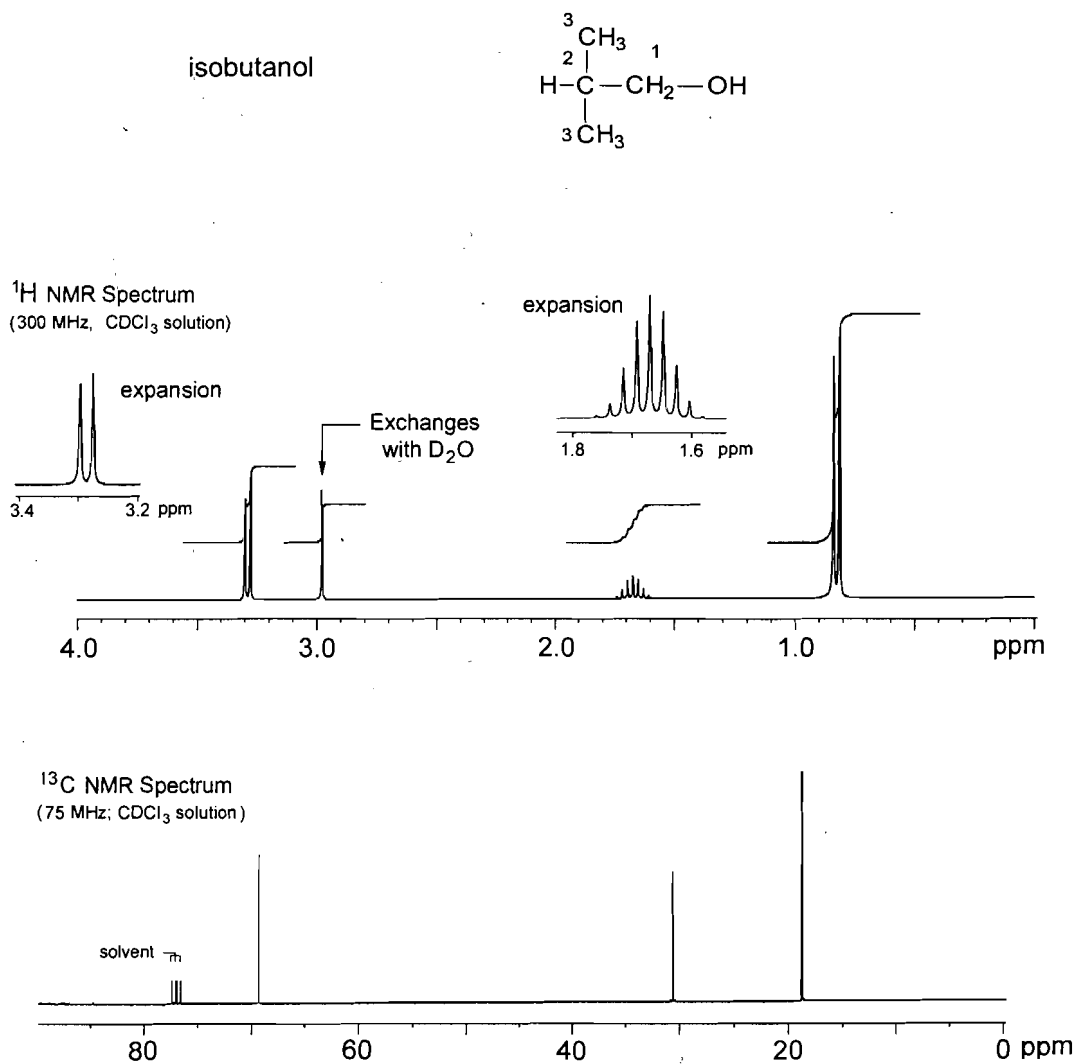

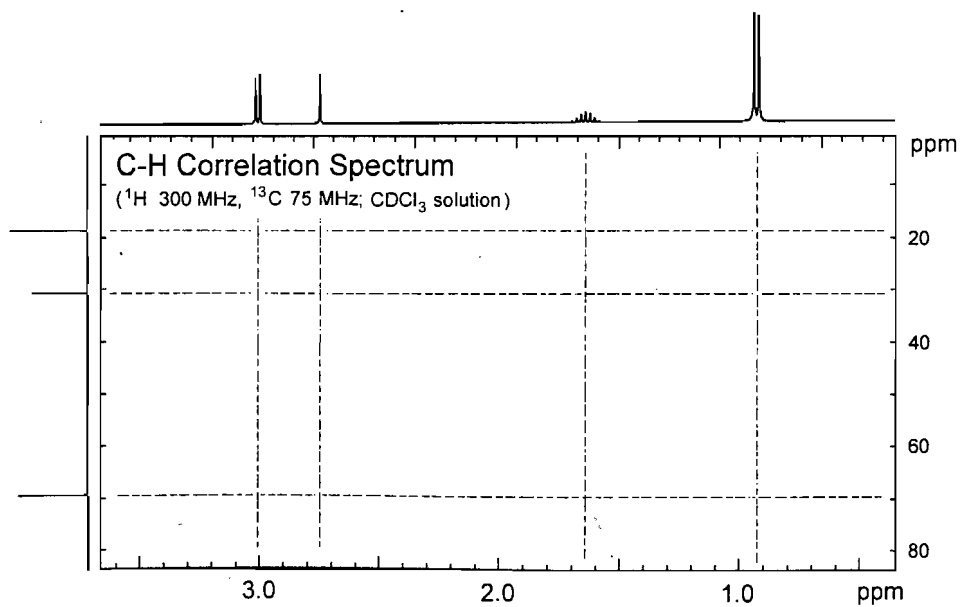
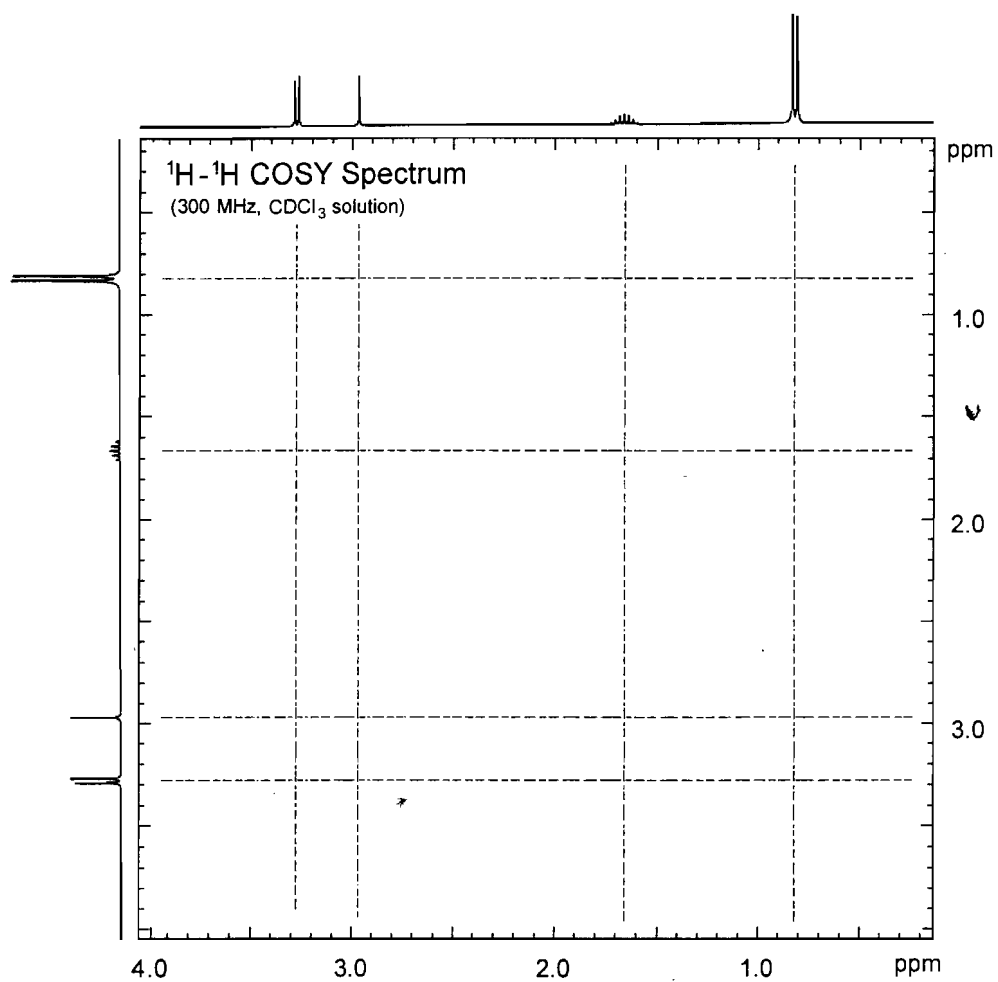

## Problem 295

The  $^1\text{H}$  spectrum of 3-heptanone ( $\text{C}_7\text{H}_{14}\text{O}$ ) recorded in  $\text{C}_6\text{D}_6$  solution at 298K at 500 MHz is given below. The  $^1\text{H}$  spectrum has signals at  $\delta$  0.79, 0.91, 1.14, 1.44, 1.94 and 1.97 (partly overlapped) ppm. The 2-dimensional  $^1\text{H}$ - $^1\text{H}$  COSY spectrum is given on the facing page. From the COSY spectrum, assign the proton spectrum *i.e.* determine the chemical shift corresponding to each of the protons in the molecule.

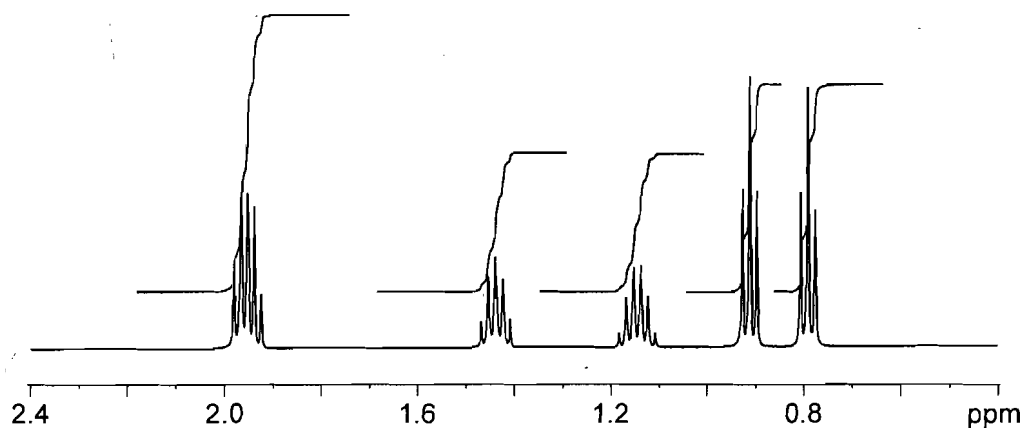
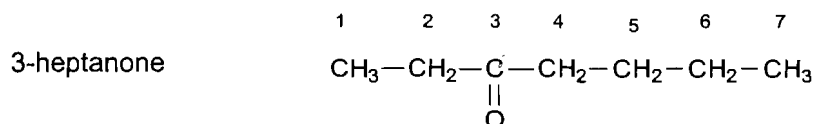

Proton	Chemical Shift ( $\delta$ ) in ppm
H1	
H2	
H4	
H5	
H6	
H7	

$^1\text{H}$  COSY spectrum of 3-heptanone (recorded in  $\text{C}_6\text{D}_6$  solution at 298K, at 500 MHz).

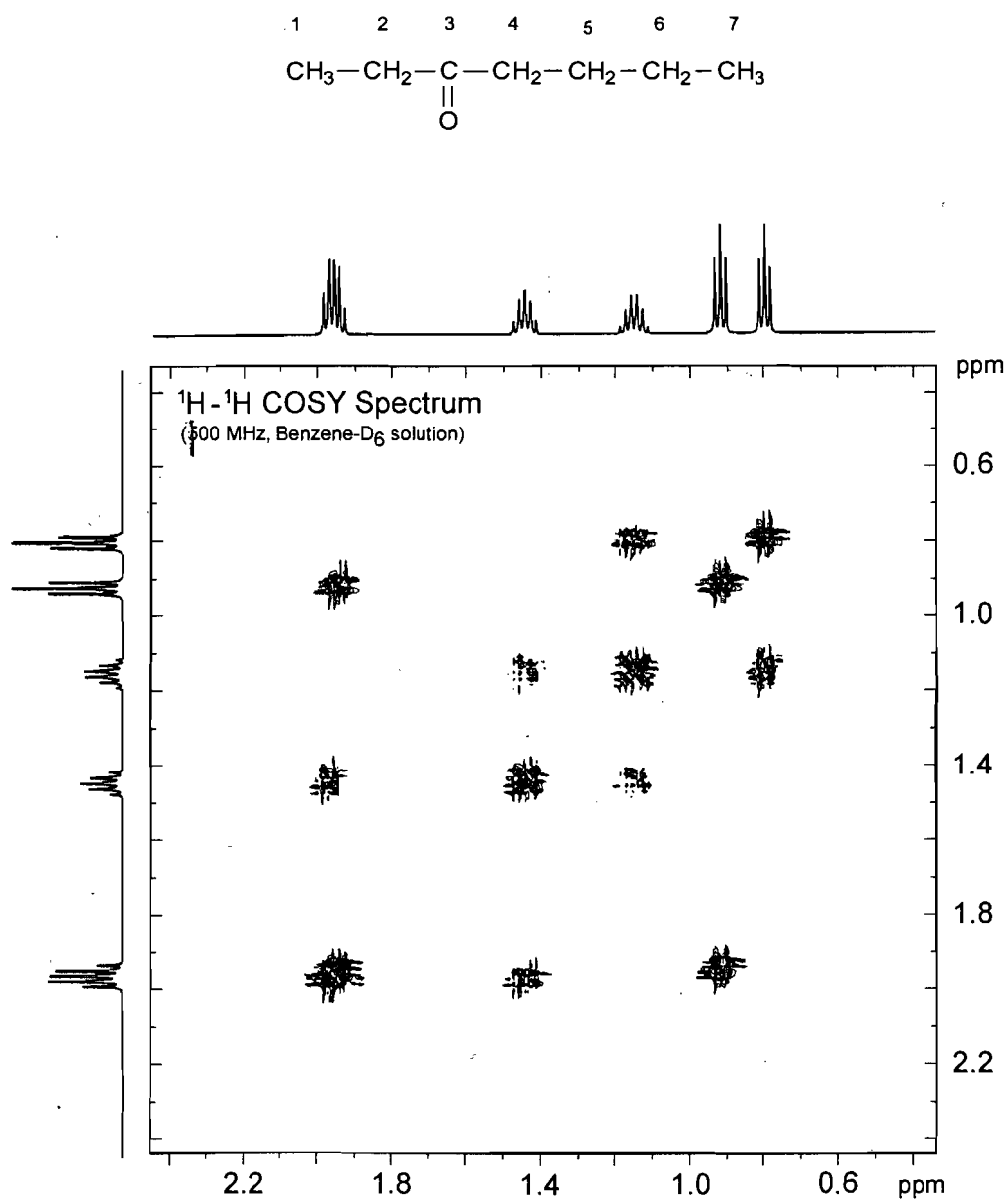



## Problem 296

The  $^1\text{H}$  and  $^{13}\text{C}$  NMR spectra of  $\delta$ -valerolactone ( $\text{C}_5\text{H}_8\text{O}_2$ ) are given below recorded in  $\text{C}_6\text{D}_6$  solution at 298K, at 600 MHz. The  $^1\text{H}$  spectrum has signals at  $\delta$  1.08, 1.16, 2.08, and 3.71 ppm. The  $^{13}\text{C}$  spectrum has signals at  $\delta$  19.0, 22.2, 29.9, 68.8 and 170.0 ppm. The 2-dimensional  $^1\text{H}$ - $^1\text{H}$  COSY spectrum and the C-H correlation spectrum are given on the facing page. From the COSY spectrum, assign the proton spectrum and use this information to assign the  $^{13}\text{C}$  spectrum.

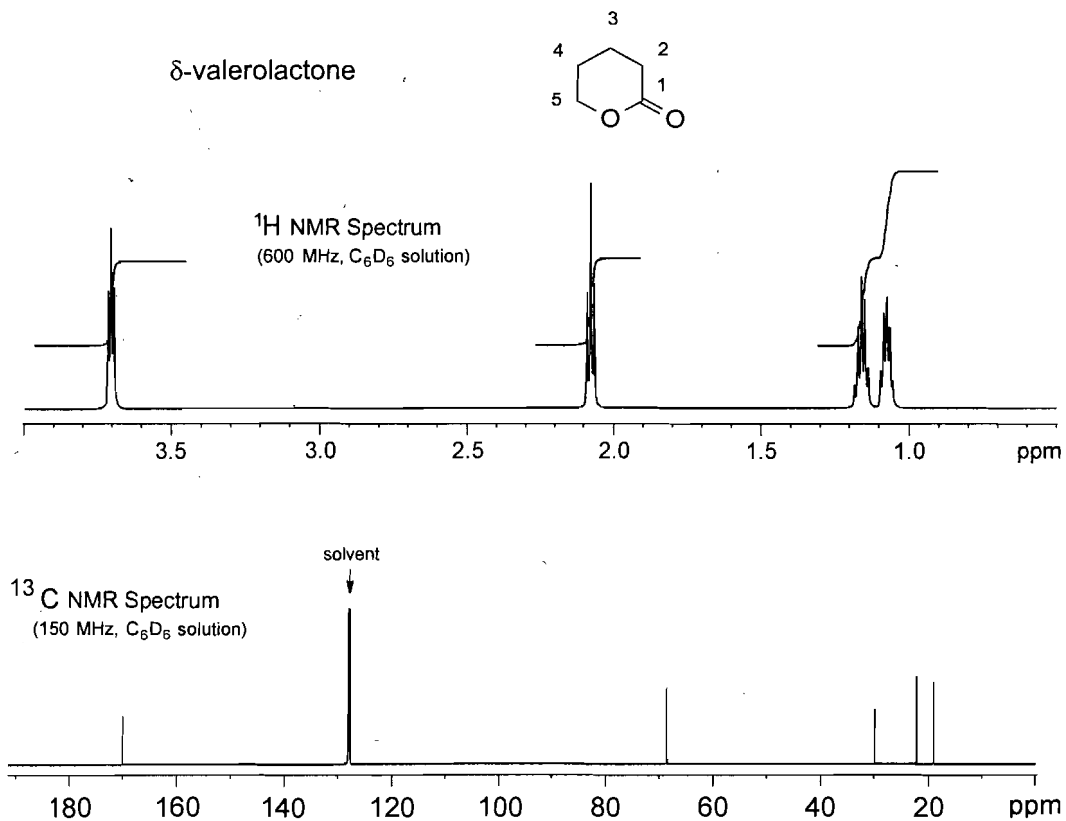

Proton	Chemical Shift ( $\delta$ ) in ppm	Carbon	Chemical Shift ( $\delta$ ) in ppm
		C1	
H2		C2	
H3		C3	
H4		C4	
H5		C5	

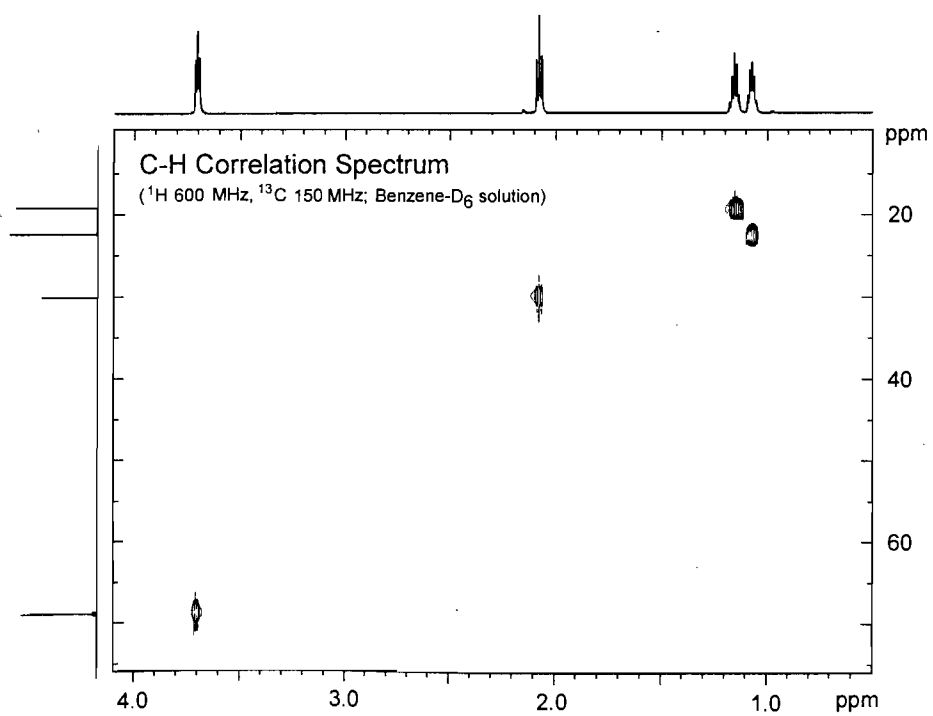
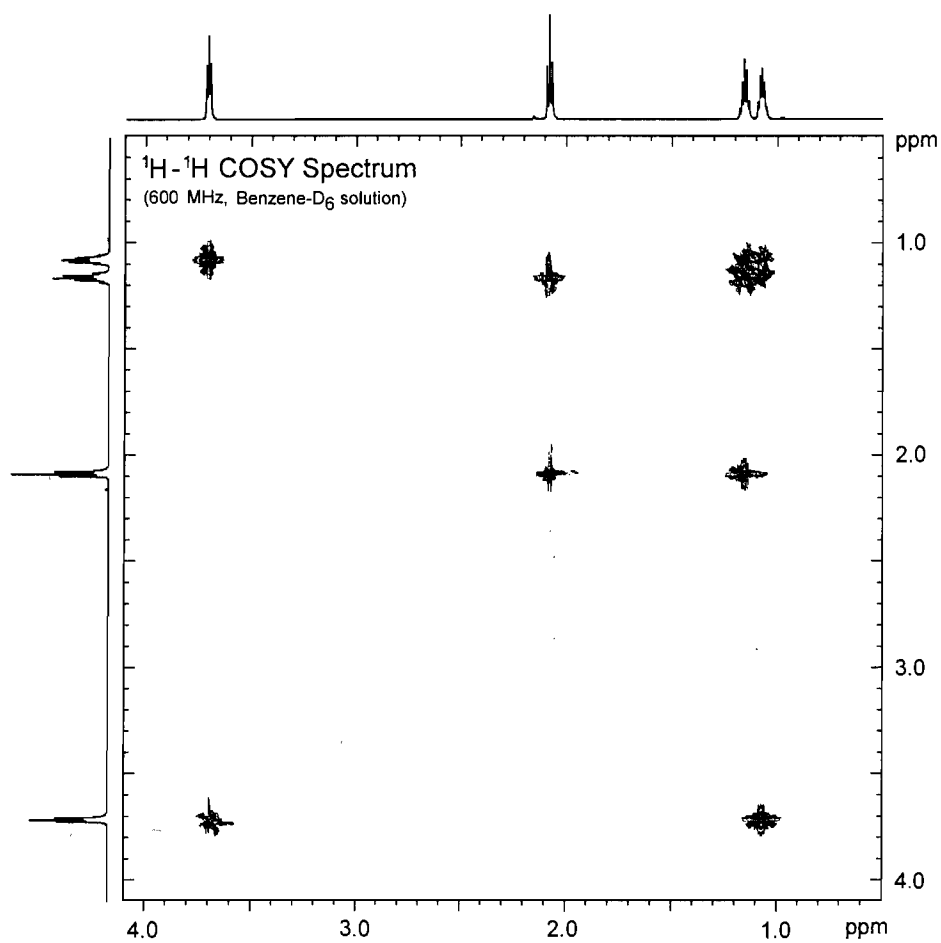

## Problem 297

The  $^1\text{H}$  and  $^{13}\text{C}$  NMR spectra of 1-bromobutane ( $\text{C}_4\text{H}_9\text{Br}$ ) are given below. The  $^1\text{H}$  spectrum has signals at  $\delta$  0.91, 1.45, 1.82, and 3.39 ppm. The  $^{13}\text{C}$  spectrum has signals at  $\delta$  13.2, 21.4, 33.4 and 34.7 ppm. The 2-dimensional  $^1\text{H}$ - $^1\text{H}$  COSY spectrum and the C-H correlation spectrum are given on the facing page. From the COSY spectrum, deduce the assignment of the proton spectrum and use this information to assign the  $^{13}\text{C}$  spectrum.

1-bromobutane

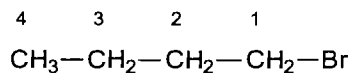

Proton	Chemical Shift ( $\delta$ ) in ppm	Carbon	Chemical Shift ( $\delta$ ) in ppm
H1		C1	
H2		C2	
H3		C3	
H4		C4	

$^1\text{H}$  NMR Spectrum  
(400 MHz,  $\text{CDCl}_3$  solution)

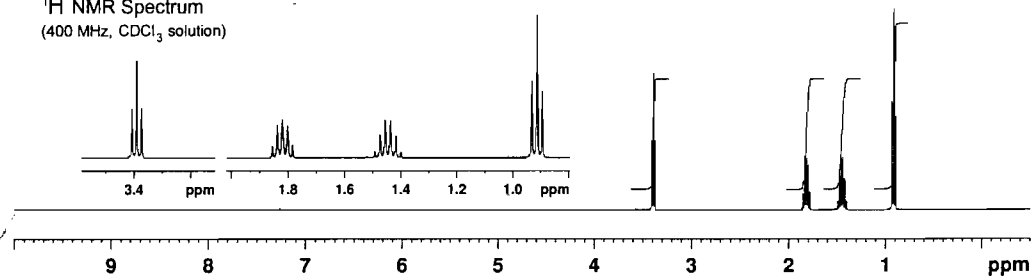

$^{13}\text{C}$  NMR Spectrum  
(100 MHz,  $\text{CDCl}_3$  solution)

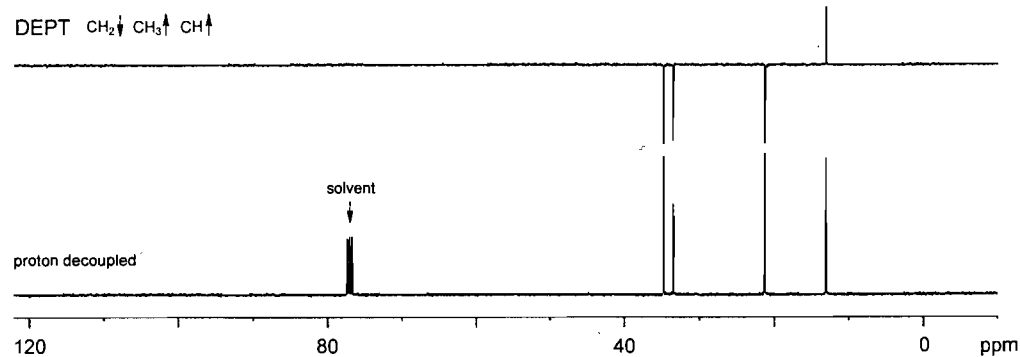

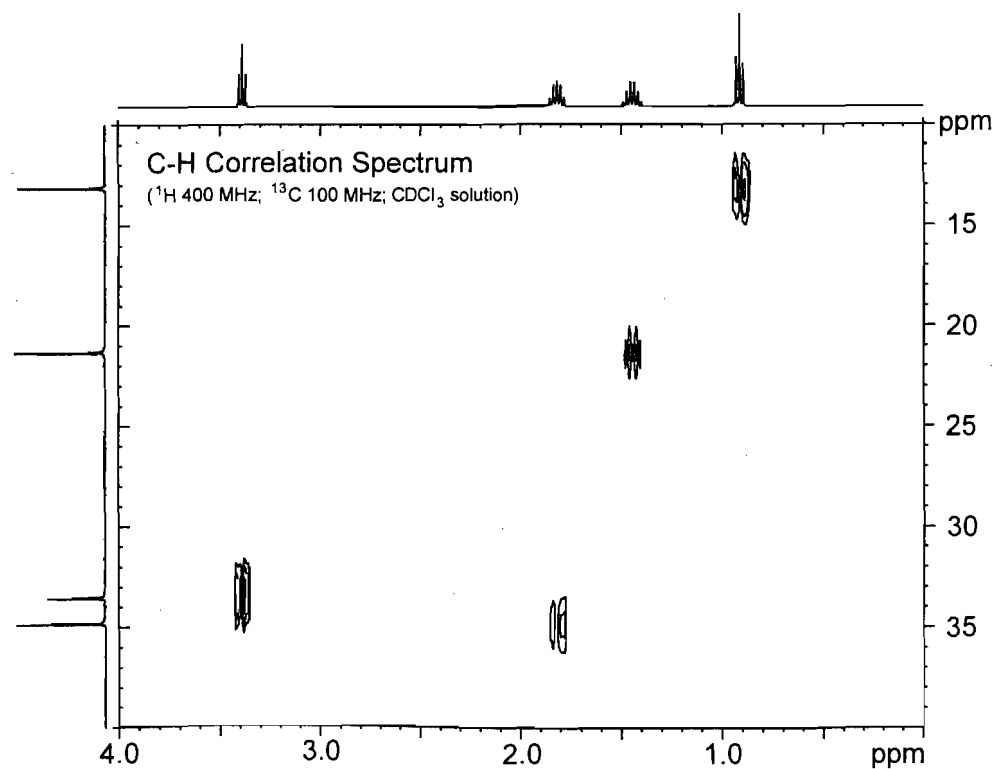
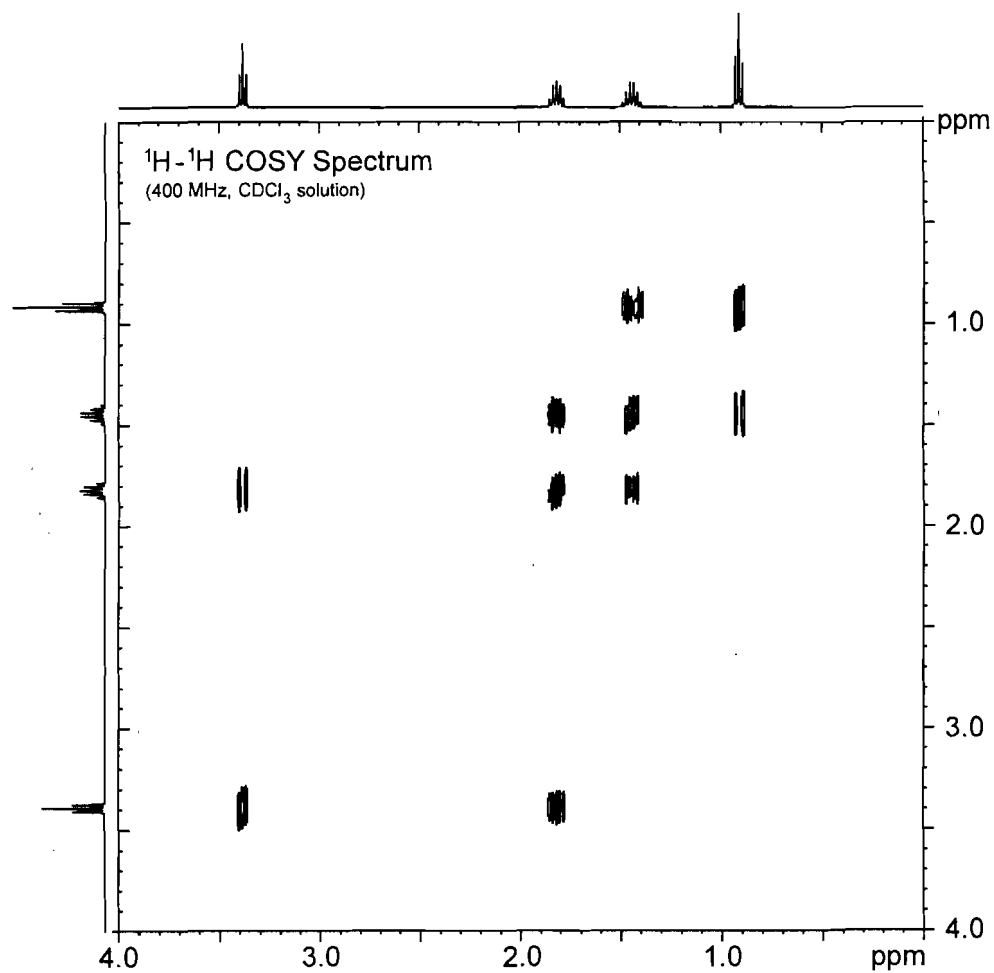



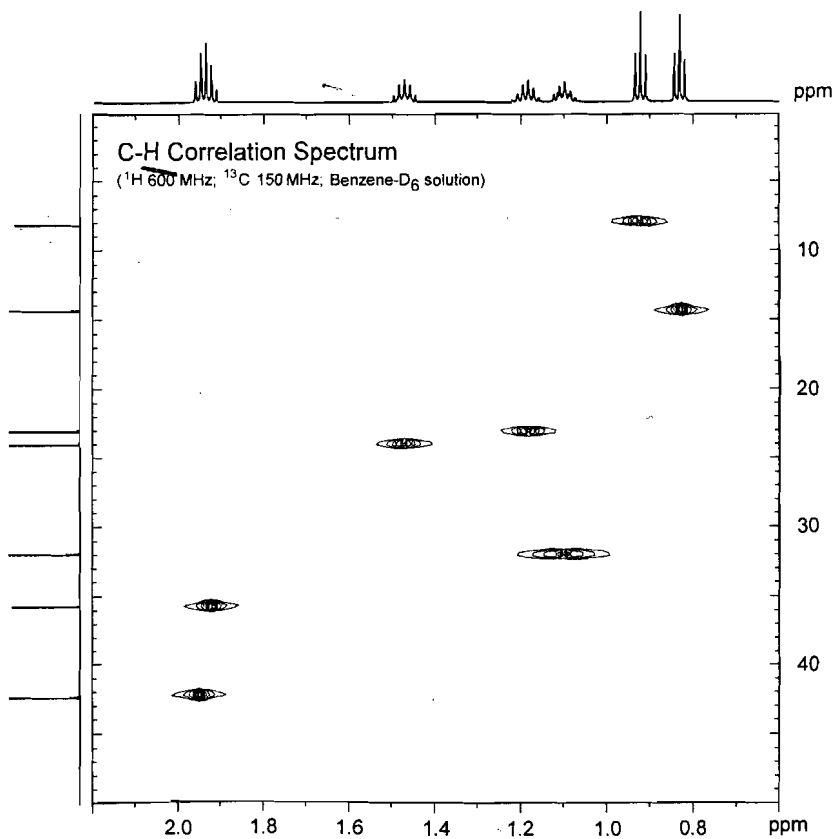
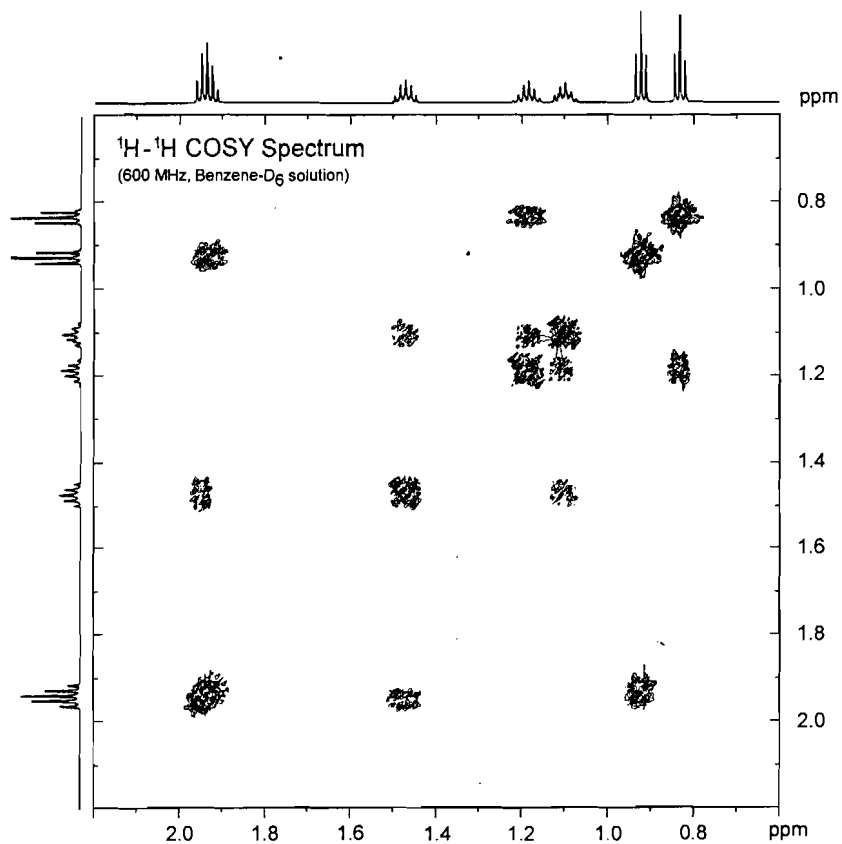

# Problem 299

The  $^1\text{H}$  and  $^{13}\text{C}$  NMR spectra of diethyl diethylmalonate ( $\text{C}_{11}\text{H}_{20}\text{O}_4$ ) recorded 298K in  $\text{CDCl}_3$  solution are given below. The  $^1\text{H}$  spectrum has signals at  $\delta$  0.76, 1.19, 1.88 and 4.13 ppm. The  $^{13}\text{C}$  spectrum has signals at  $\delta$  8.1, 14.0, 24.5, 58.0, 60.8 and 171.9 ppm. The 2-dimensional  $^1\text{H}$ - $^1\text{H}$  COSY spectrum and the C-H correlation spectrum are given on the facing page. From the COSY spectrum, assign the proton spectrum and use this information to assign the  $^{13}\text{C}$  spectrum.

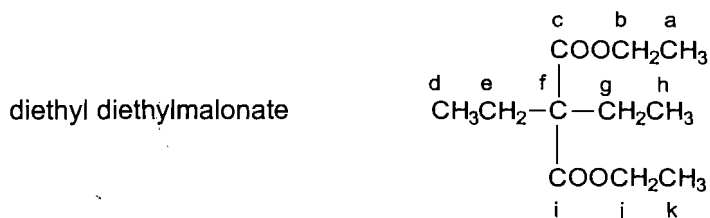

Proton	Chemical Shift ( $\delta$ ) In ppm	Carbon	Chemical Shift ( $\delta$ ) in ppm
$\text{H}_a$		$\text{C}_a$	
$\text{H}_b$		$\text{C}_b$	
		$\text{C}_c$	
$\text{H}_d$		$\text{C}_d$	
$\text{H}_e$		$\text{C}_e$	
		$\text{C}_f$	
$\text{H}_g$		$\text{C}_g$	
$\text{H}_h$		$\text{C}_h$	
		$\text{C}_i$	
$\text{H}_j$		$\text{C}_j$	
$\text{H}_k$		$\text{C}_k$	

$^1\text{H}$  NMR Spectrum  
(300 MHz,  $\text{CDCl}_3$  solution)

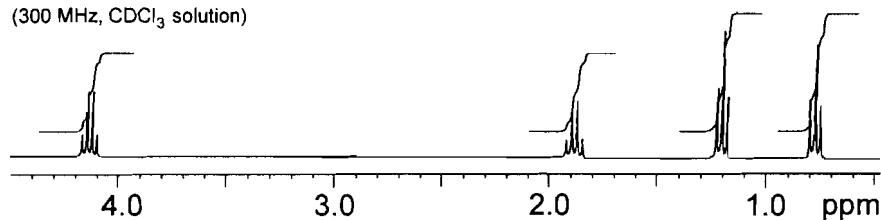

$^{13}\text{C}$  NMR Spectrum  
(75 MHz,  $\text{CDCl}_3$  solution)

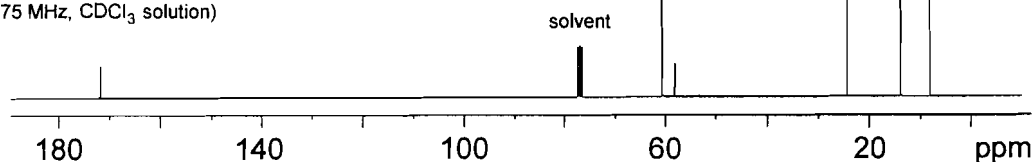

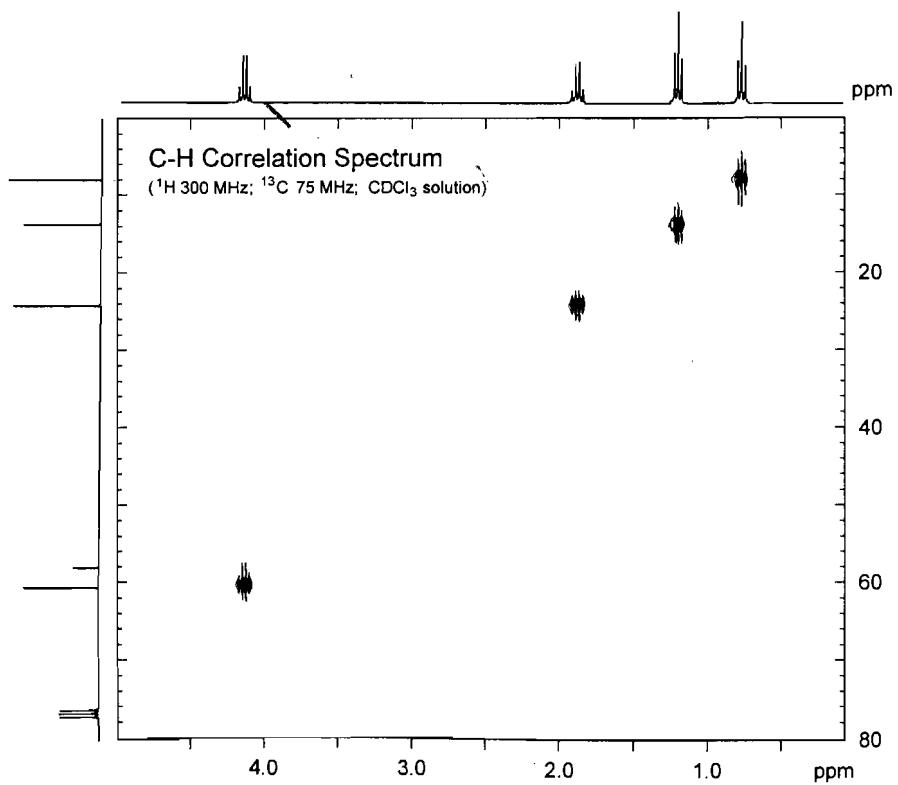
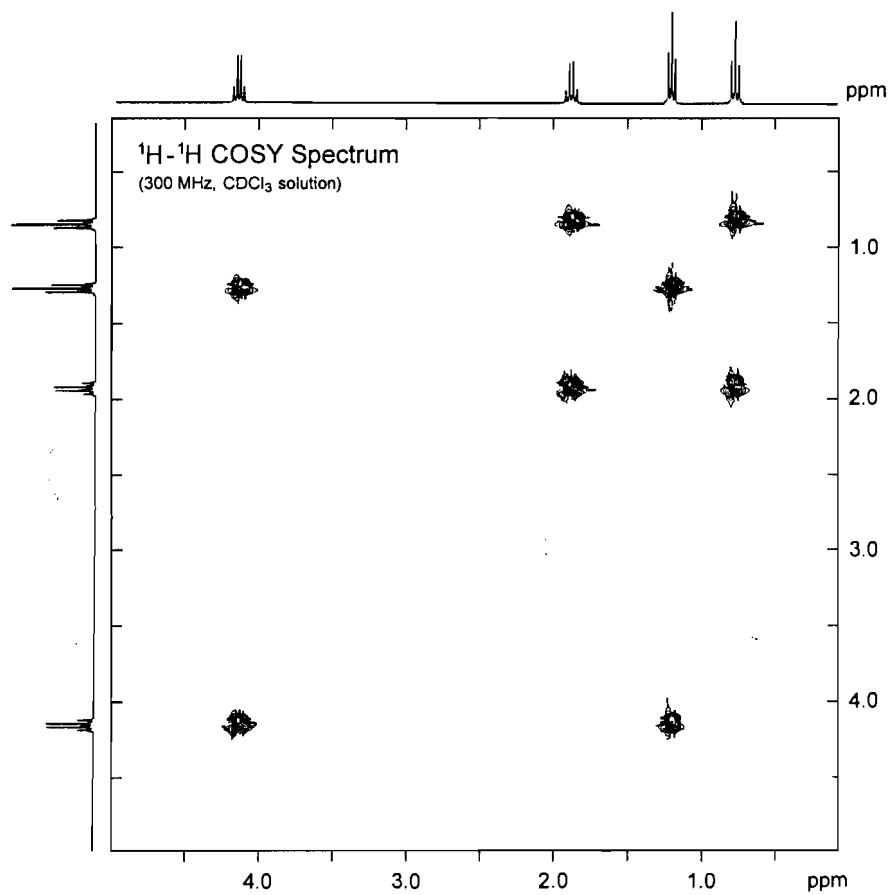



# Problem 300

The  $^1\text{H}$  and  $^{13}\text{C}$  NMR spectra of butyl ethyl ether ( $\text{C}_6\text{H}_{14}\text{O}$ ) recorded at 298K in  $\text{CDCl}_3$  solution are given below. The  $^1\text{H}$  spectrum has signals at  $\delta$  0.87, 1.11, 1.36, 1.52, 3.27 and 3.29 (partly overlapped) ppm. The  $^{13}\text{C}$  spectrum has signals at  $\delta$  13.5, 15.0, 19.4, 32.1, 66.0 and 70.1 ppm. The 2-dimensional  $^1\text{H}$ - $^1\text{H}$  COSY spectrum and the C-H correlation spectrum are given on the facing page. From the COSY spectrum, assign the proton spectrum and use this information to assign the  $^{13}\text{C}$  spectrum.

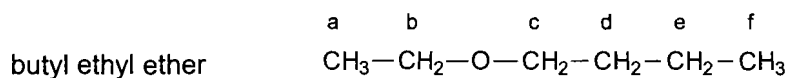

Proton	Chemical Shift ( $\delta$ ) in ppm	Carbon	Chemical Shift ( $\delta$ ) in ppm
$\text{H}_a$		$\text{C}_a$	
$\text{H}_b$		$\text{C}_b$	
$\text{H}_c$		$\text{C}_c$	
$\text{H}_d$		$\text{C}_d$	
$\text{H}_e$		$\text{C}_e$	
$\text{H}_f$		$\text{C}_f$	

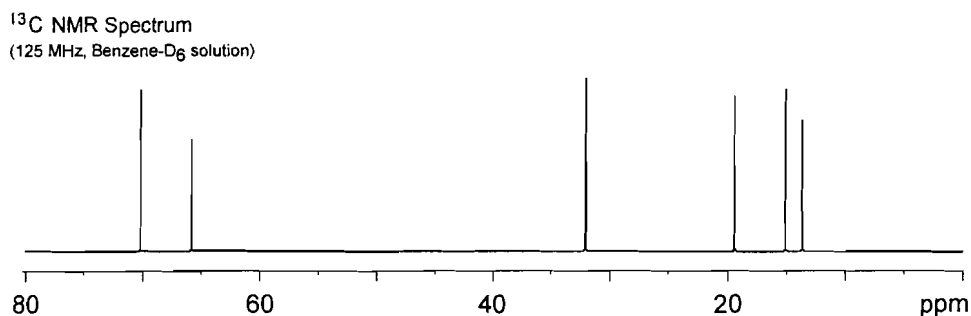
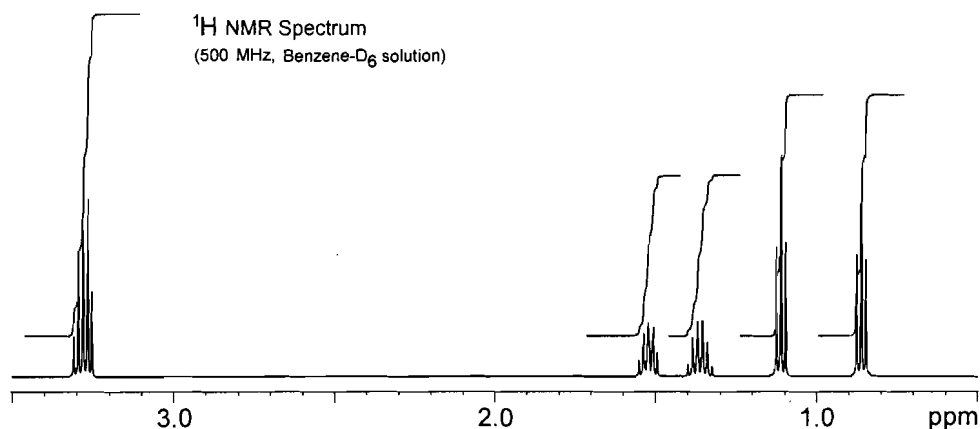

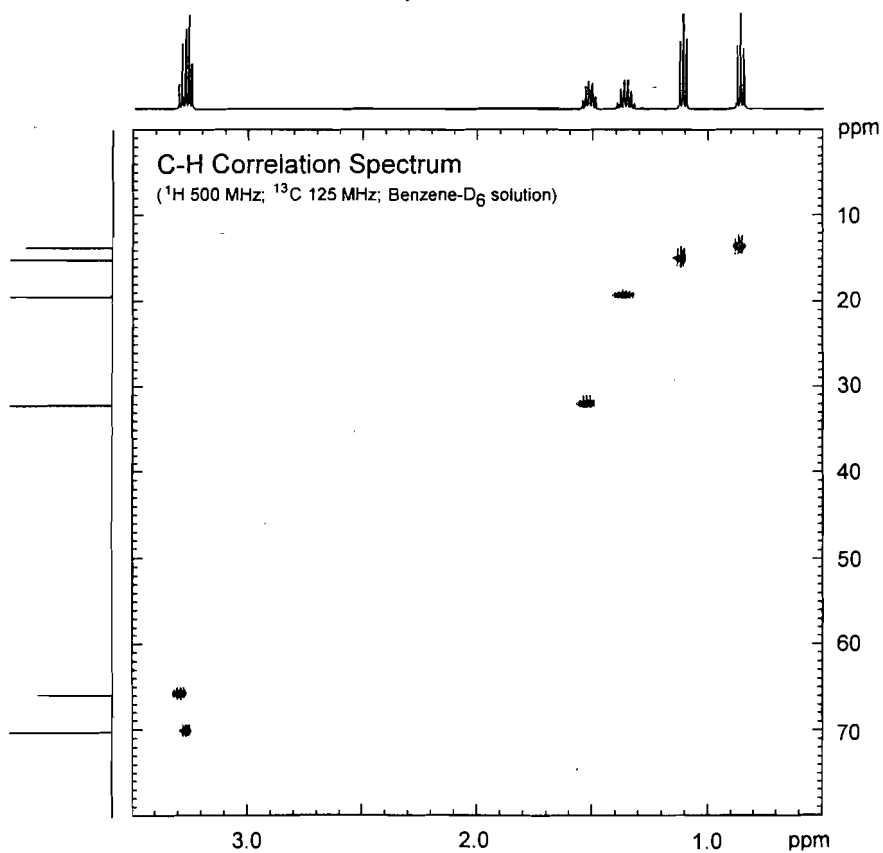
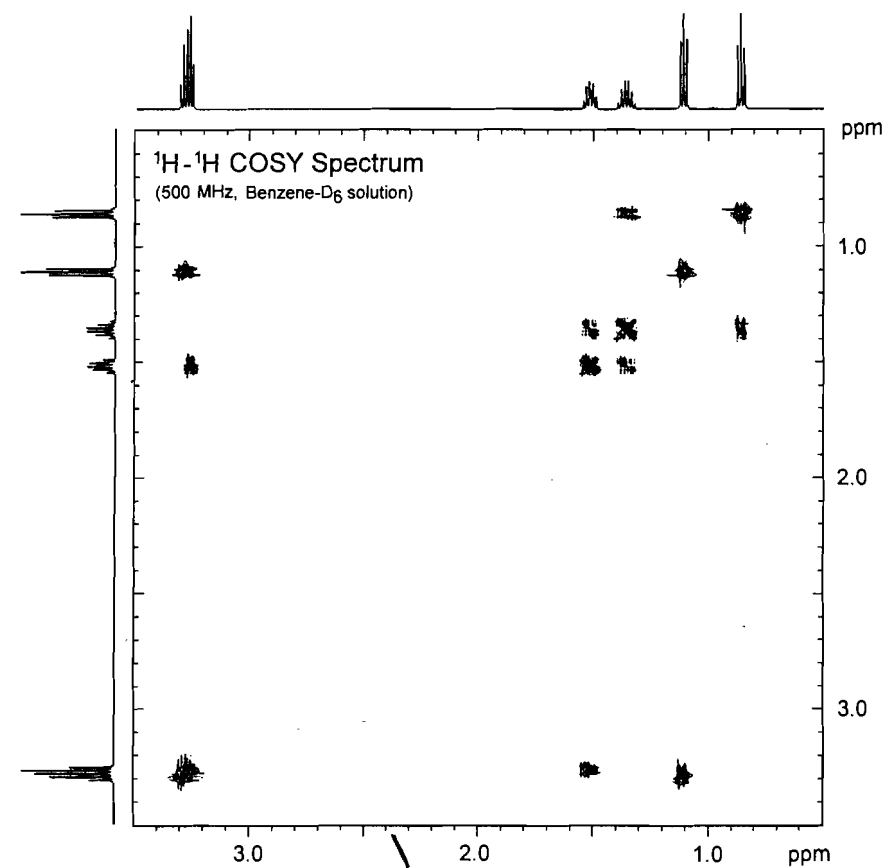

# Problem 301

The  $^1\text{H}$  and  $^{13}\text{C}$  NMR spectra of butyl butyrate recorded at 298K in  $\text{C}_6\text{D}_6$  solution are given below. The  $^1\text{H}$  spectrum has signals at  $\delta$  0.75, 0.79 (partly overlapped), 1.19, 1.40, 1.52, 2.08 and 3.97 ppm. The  $^{13}\text{C}$  spectrum has signals at  $\delta$  13.9 (2 overlapped resonances), 19.0, 19.5, 31.2, 36.2, 64.0 and 172.8 ppm. The 2-dimensional  $^1\text{H}$ - $^1\text{H}$  COSY spectrum and the C-H correlation spectrum are given on the facing page. From the COSY spectrum, assign the proton spectrum and use this information to assign the  $^{13}\text{C}$  spectrum.

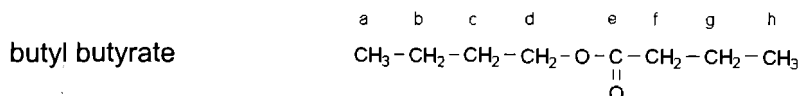

Proton	Chemical Shift ( $\delta$ ) in ppm	Carbon	Chemical Shift ( $\delta$ ) in ppm
H <sub>a</sub>		C <sub>a</sub>	
H <sub>b</sub>		C <sub>b</sub>	
H <sub>c</sub>		C <sub>c</sub>	
H <sub>d</sub>		C <sub>d</sub>	
		C <sub>e</sub>	
H <sub>f</sub>		C <sub>f</sub>	
H <sub>g</sub>		C <sub>g</sub>	
H <sub>h</sub>		C <sub>h</sub>	

$^1\text{H}$  NMR Spectrum  
(500 MHz, Benzene- $\text{D}_6$  solution)

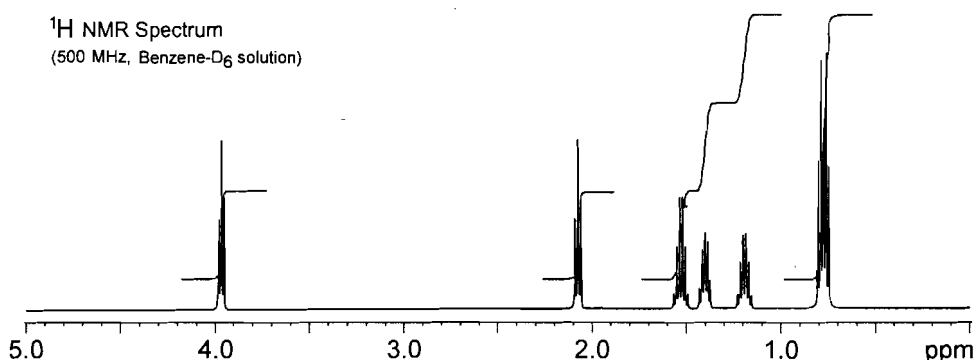

$^{13}\text{C}$  NMR Spectrum  
(125 MHz, Benzene- $\text{D}_6$  solution)

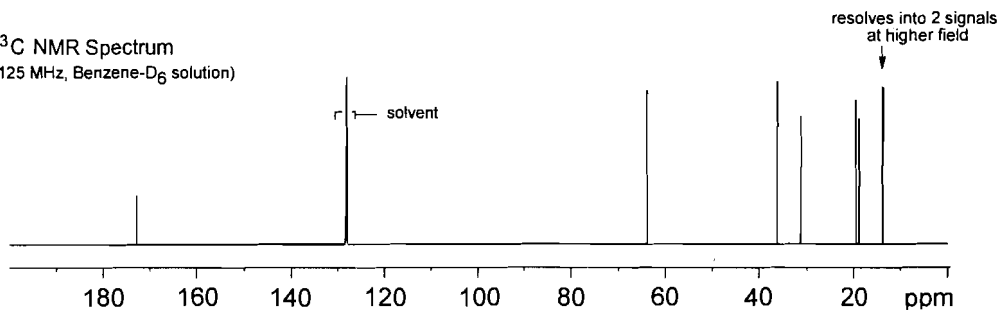

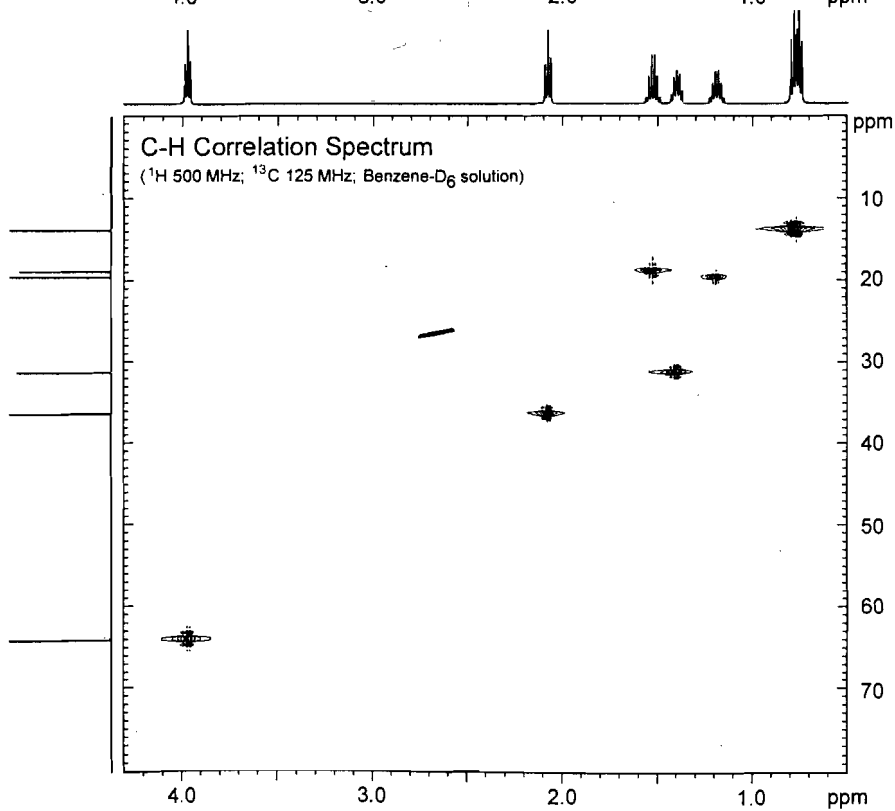
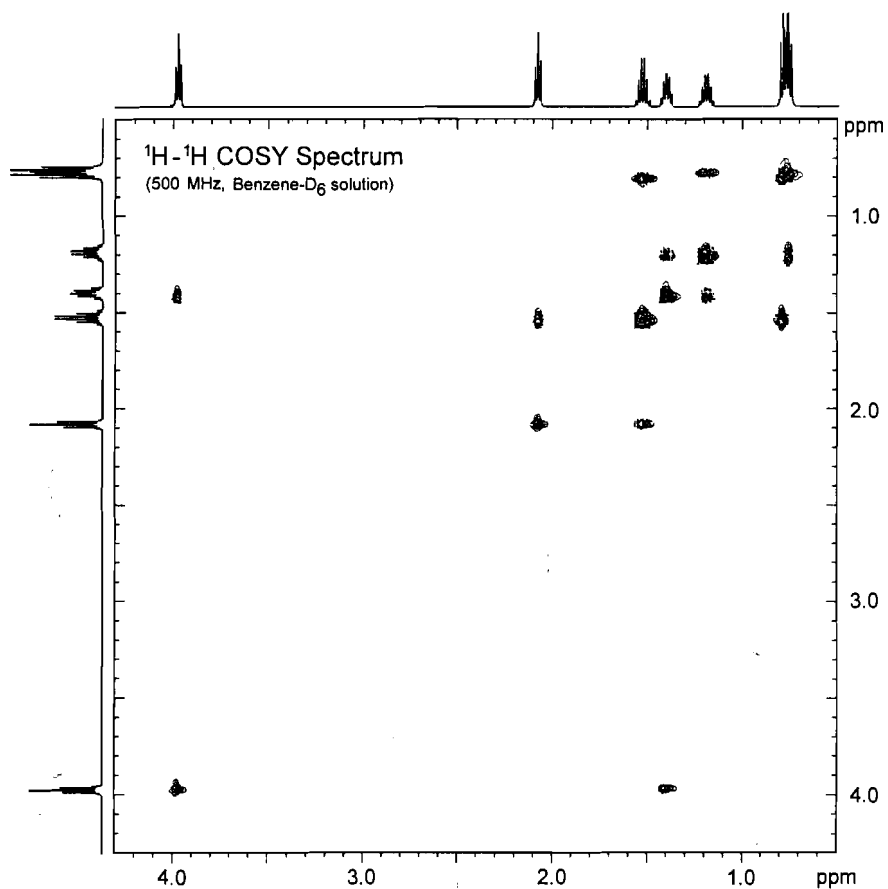



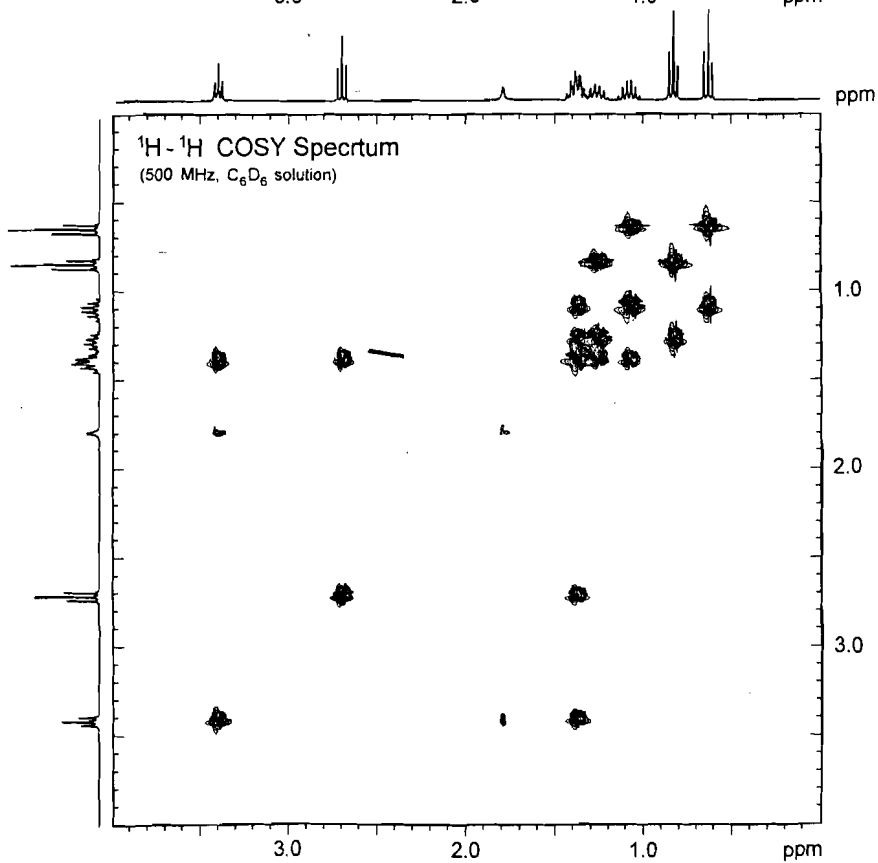
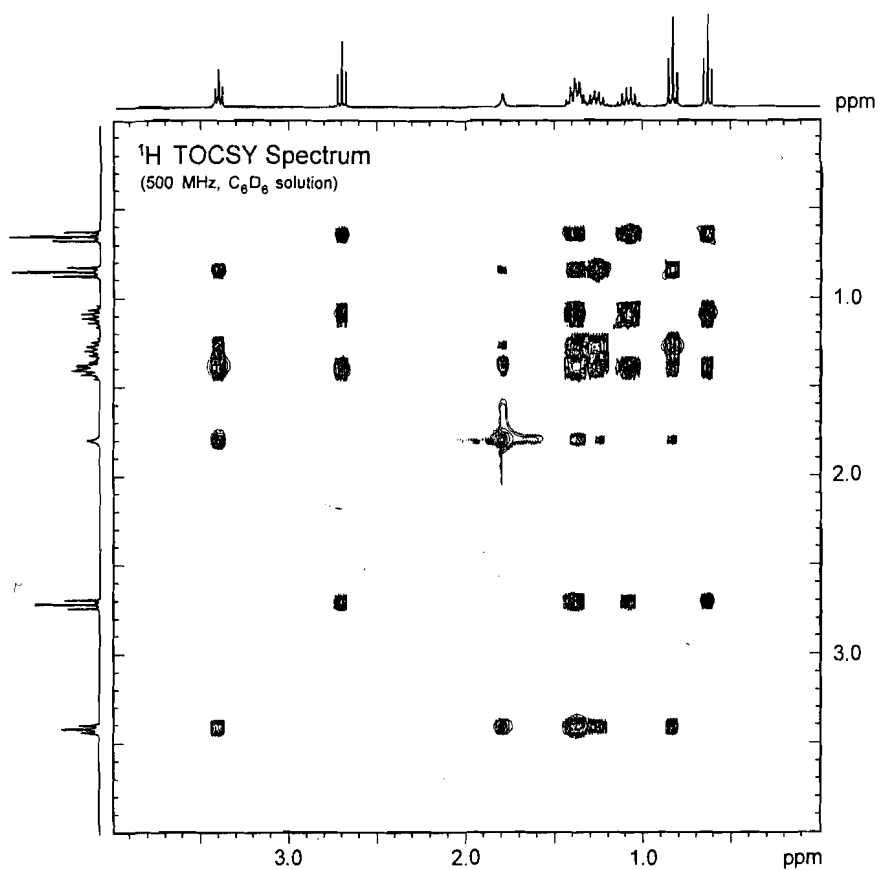

## Problem 303

The (*E*)- and (*Z*)-isomers of 2-bromo-2-butene ( $C_4H_7Br$ ) are difficult to distinguish by  $^1H$  NMR spectroscopy. Both isomers have 3 resonances (one between 5.5 and 6.0 ppm,  $-CH=C$ ; one between 2.0 and 2.5,  $-CCH_3Br$ ; and one between 1.5 and 2.0 ppm,  $-CHCH_3$ ). In principle, the isomers could be distinguished using a NOESY spectrum. On the schematic NOESY spectra below, draw in the strong peaks (diagonal and off-diagonal) that you would expect to see in the spectra of (*E*)-2-bromo-2-butene and (*Z*)-bromo-2-butene.

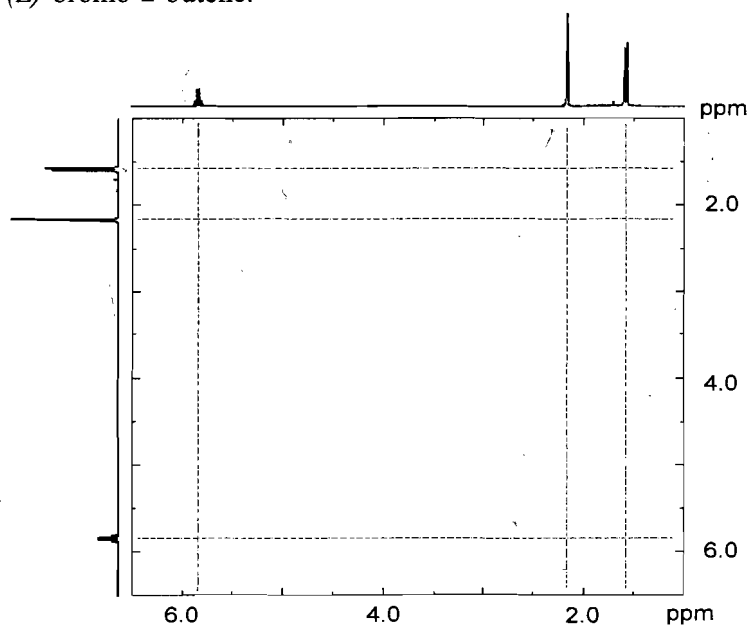

$^1H$  NOESY spectrum of (*E*)-2-bromo-2-butene, (300 MHz in  $CDCl_3$  solution)

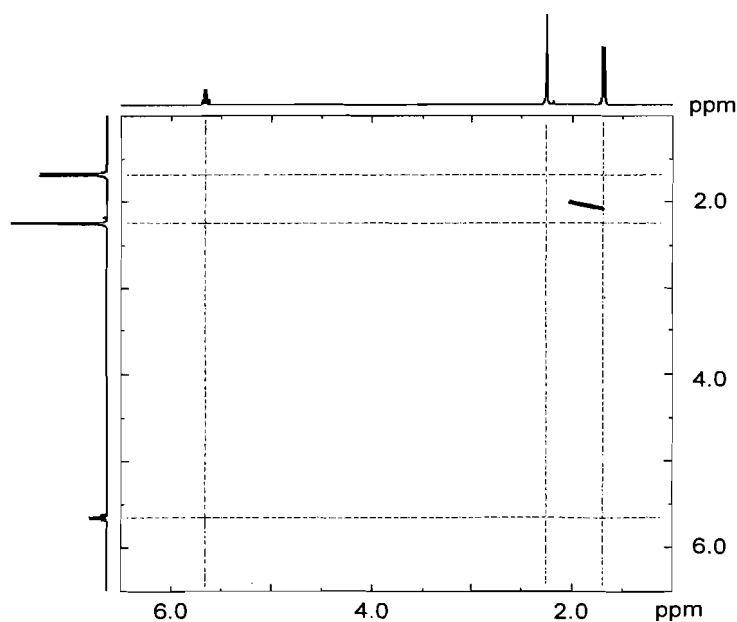
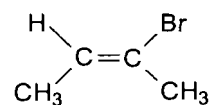

$^1H$  NOESY spectrum of (*Z*)-2-bromo-2-butene, (300 MHz in  $CDCl_3$  solution)

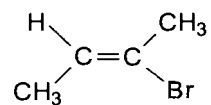

# Problem 304

The  $^1\text{H}$  NMR spectrum of one stereoisomer of 3-methylpent-2-en-4-yn-1-ol [ $\text{HC}\equiv\text{C}(\text{CH}_3)\text{C}=\text{CHCH}_2\text{OH}$ ] is given below. The 2-dimensional  $^1\text{H}$  NOESY spectrum is also given. Determine the stereochemistry of the compound and draw a structural formula for the compound indicating the stereochemistry.

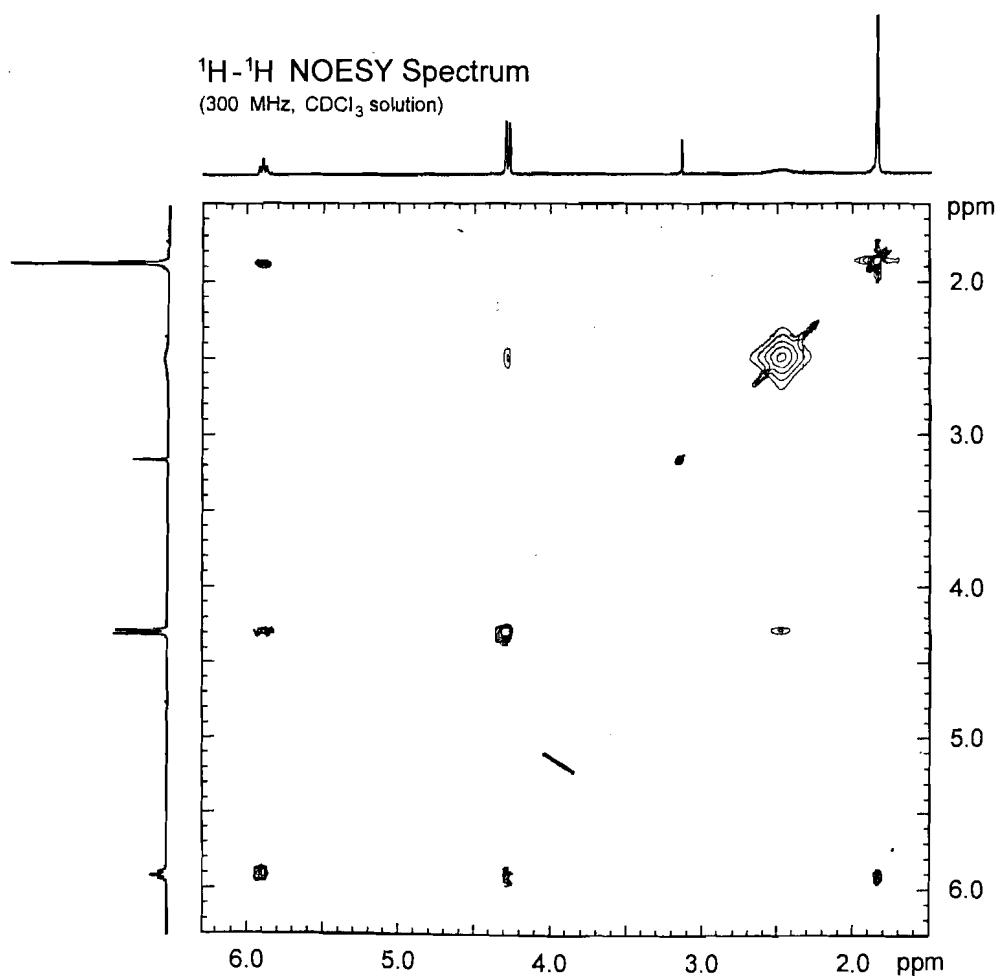
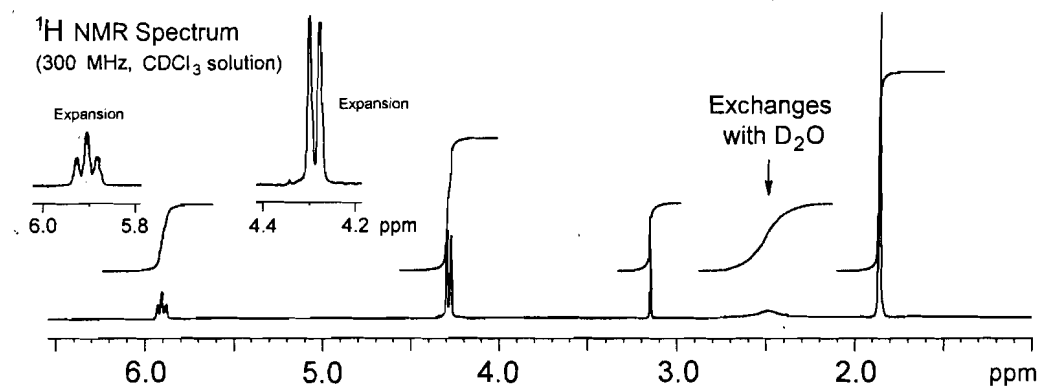



# Problem 305

The  $^1\text{H}$  NMR spectrum of 1-nitronaphthalene recorded at 298K in  $\text{CDCl}_3$  solution is given below. The 2-dimensional  $^1\text{H}$  NOESY spectrum is given on the facing page. Given that the nitro group at position 1 will always extensively deshield the proton at position 8 such that it will appear as the resonance at lowest field in the spectrum, use the NOESY spectrum to assign all of the other protons in the spectrum.

1-nitronaphthalene

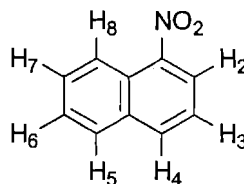

$^1\text{H}$  NMR Spectrum  
(400 MHz,  $\text{CDCl}_3$  solution)

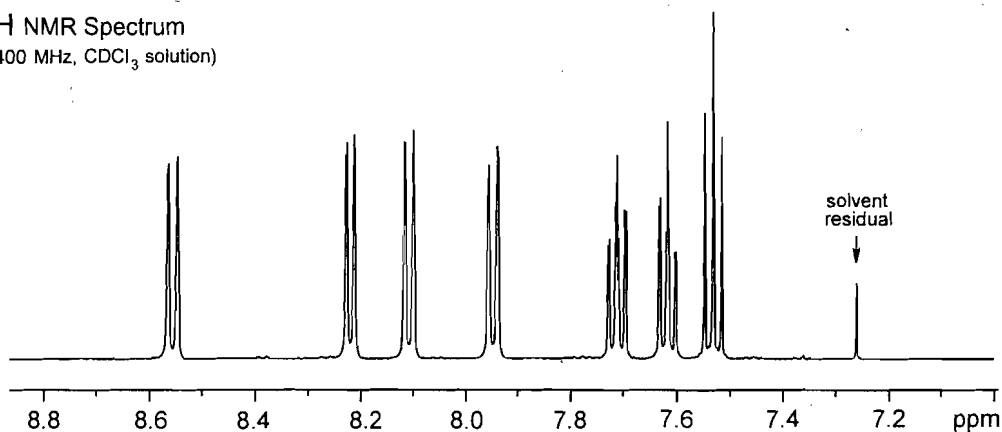

Proton	Chemical Shift ( $\delta$ ) in ppm
H2	
H3	
H4	
H5	
H6	
H7	
H8	8.56

$^1\text{H}$  NOESY spectrum of 1-nitronaphthalene (recorded in  $\text{CDCl}_3$  solution at 298K at 400 MHz).

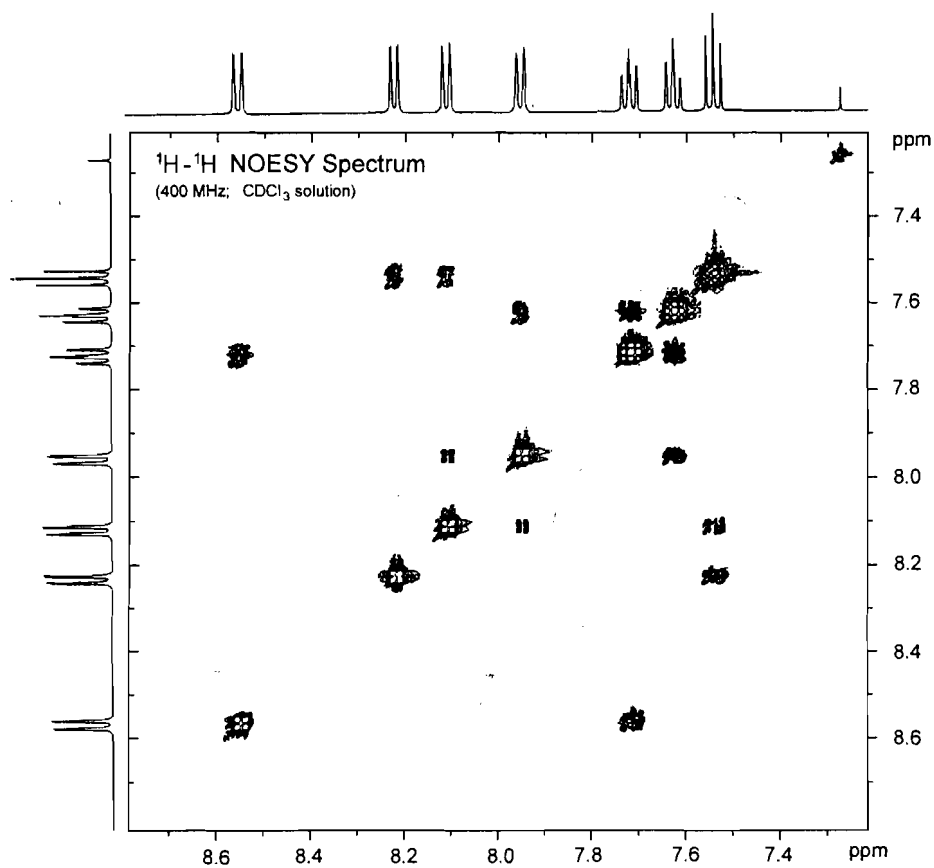
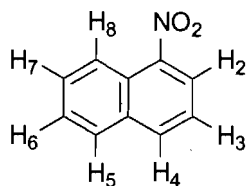

## Problem 306

Use the basic spectral data plus the COSY and C-H correlation spectra on the facing page to deduce the structure of this compound.

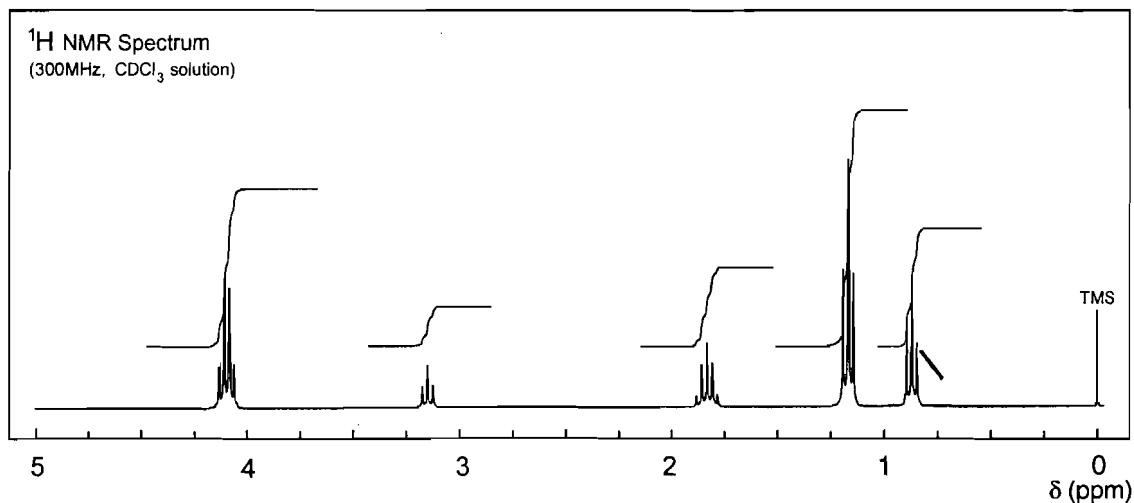
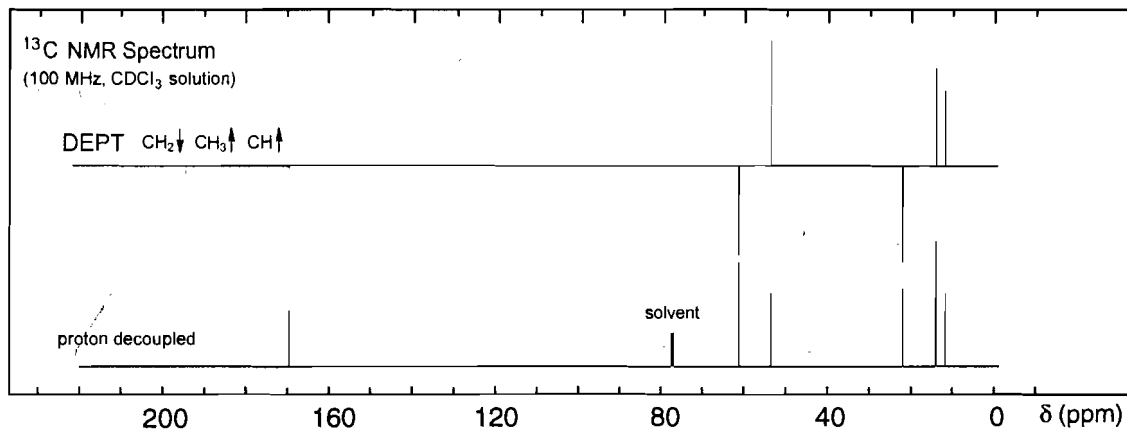
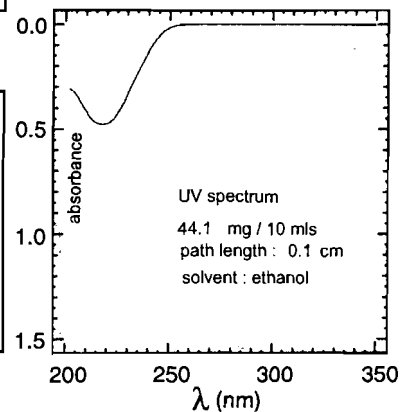
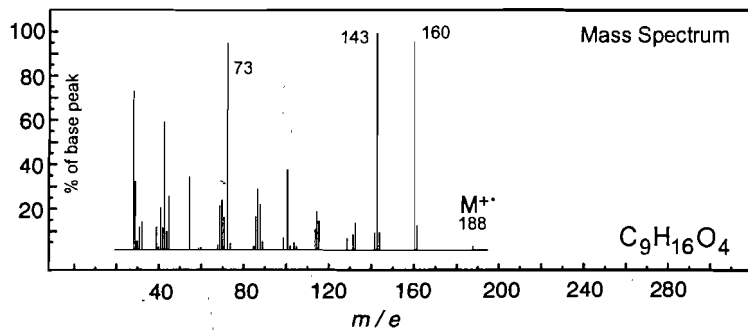
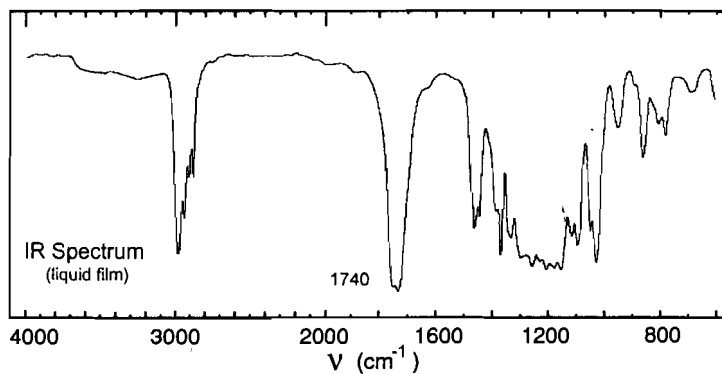

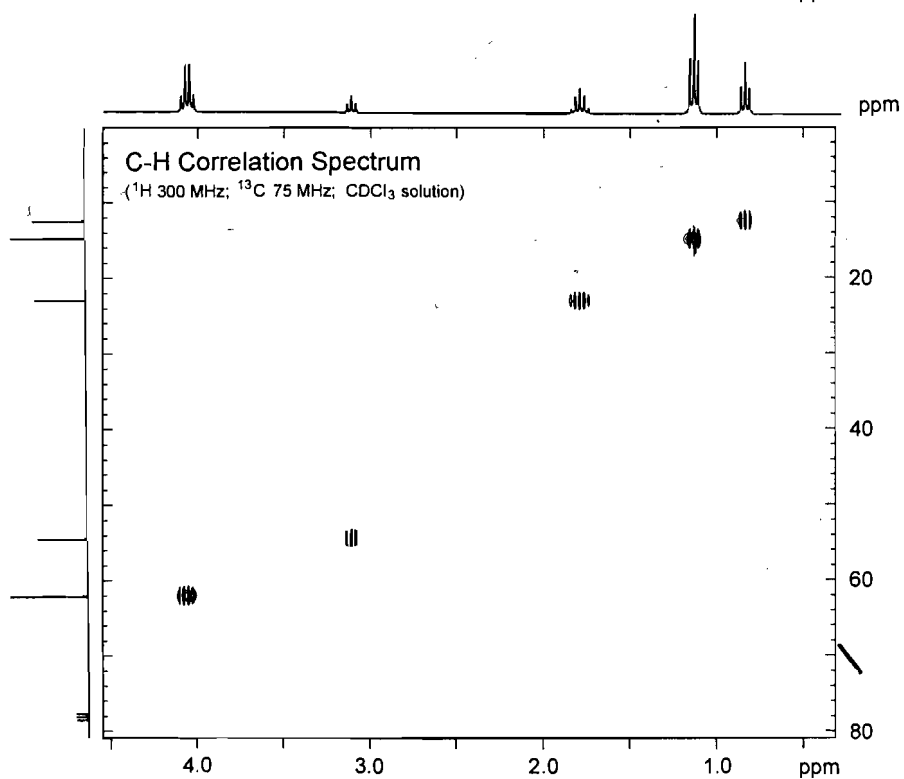
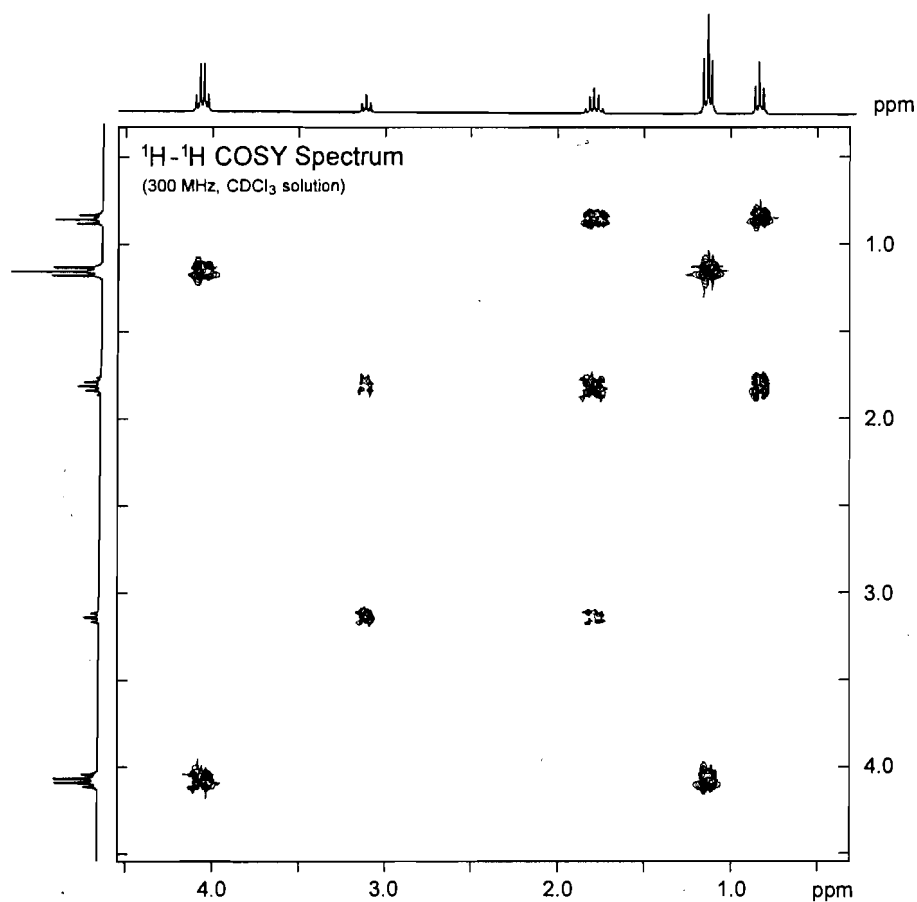

## Problem 307

Use the basic spectral data plus the COSY and C-H correlation spectra on the facing page to deduce the structure of this compound.

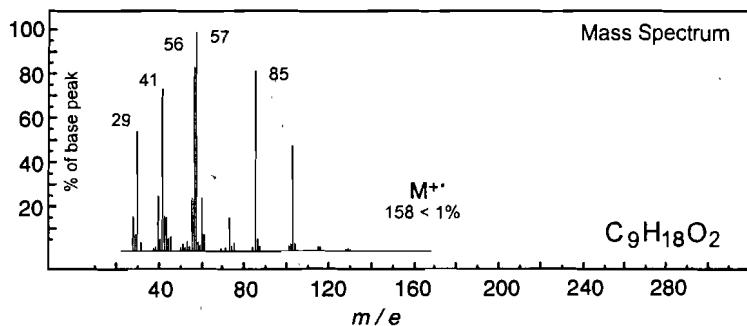
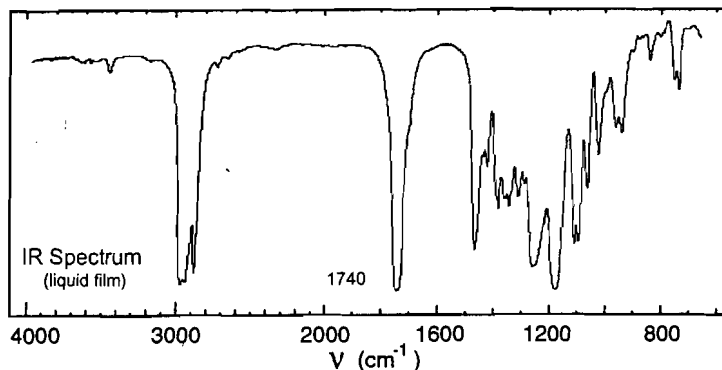

No significant UV absorption above 220 nm

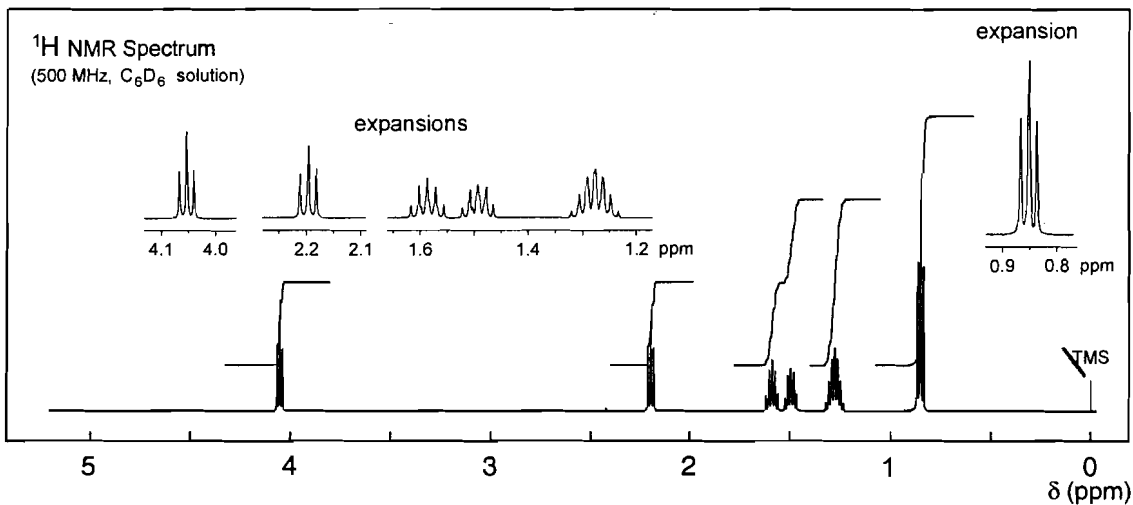
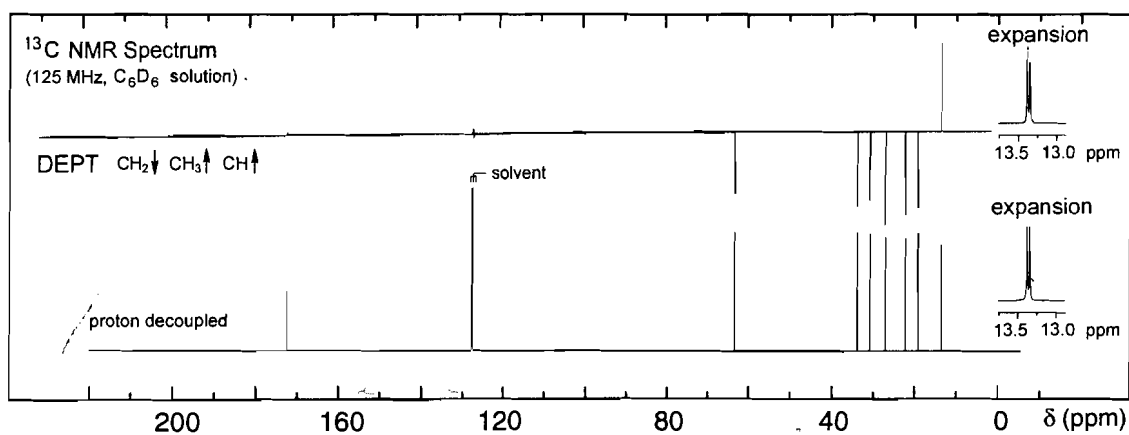

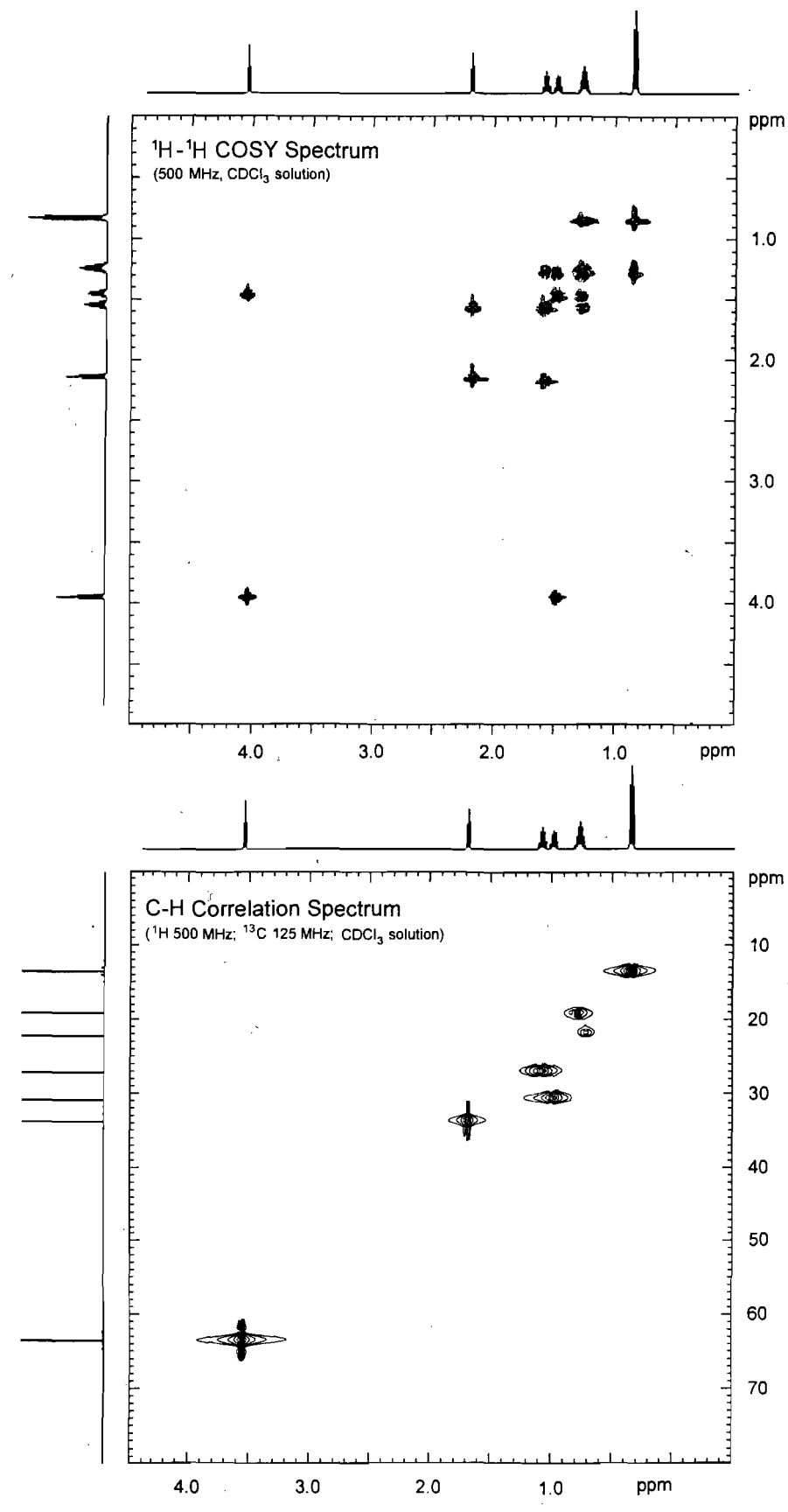

## Problem 308

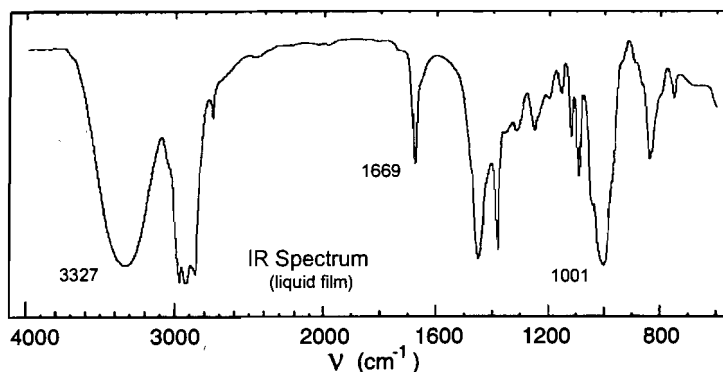

Use the basic spectral data plus the COSY and NOESY spectra on the facing page to deduce the structure, including stereochemistry of this compound.

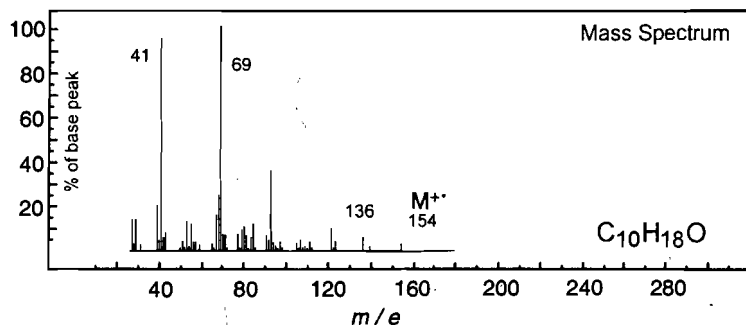

No significant UV absorption above 220 nm

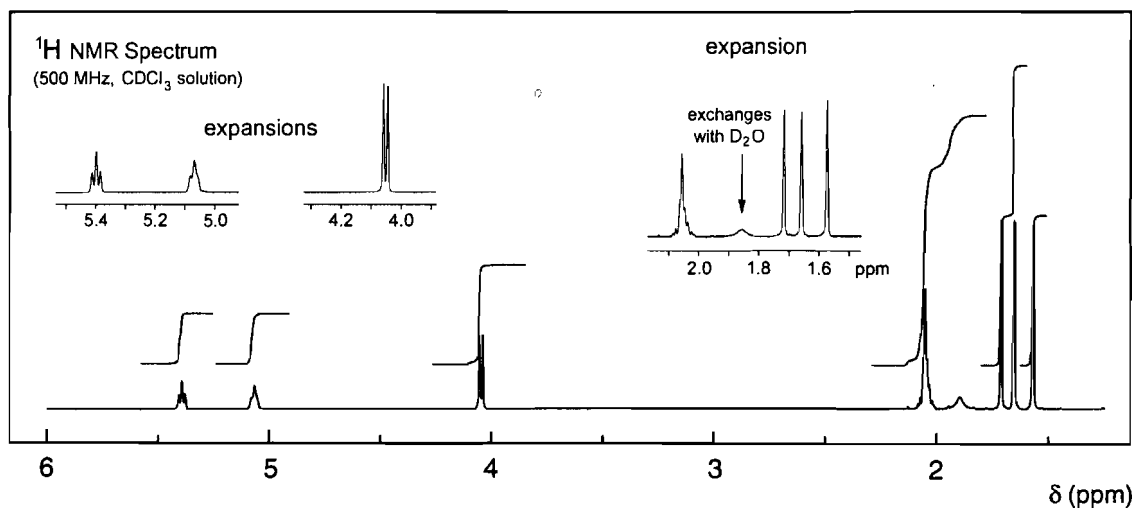
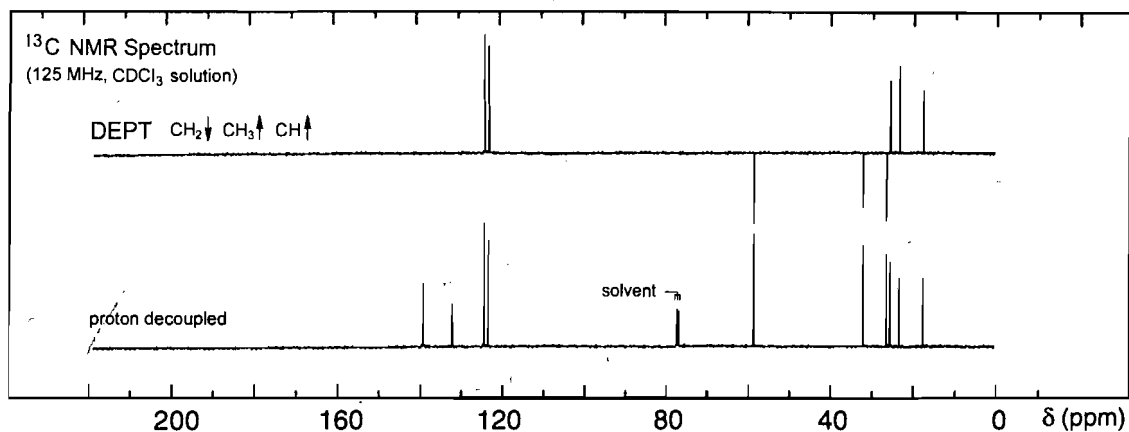

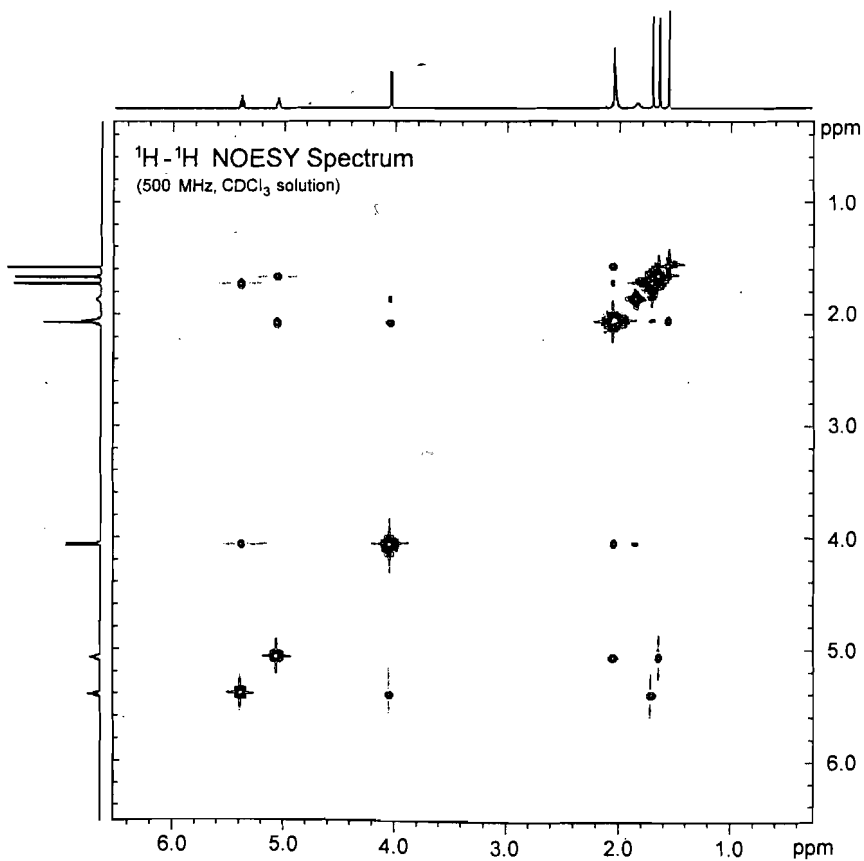
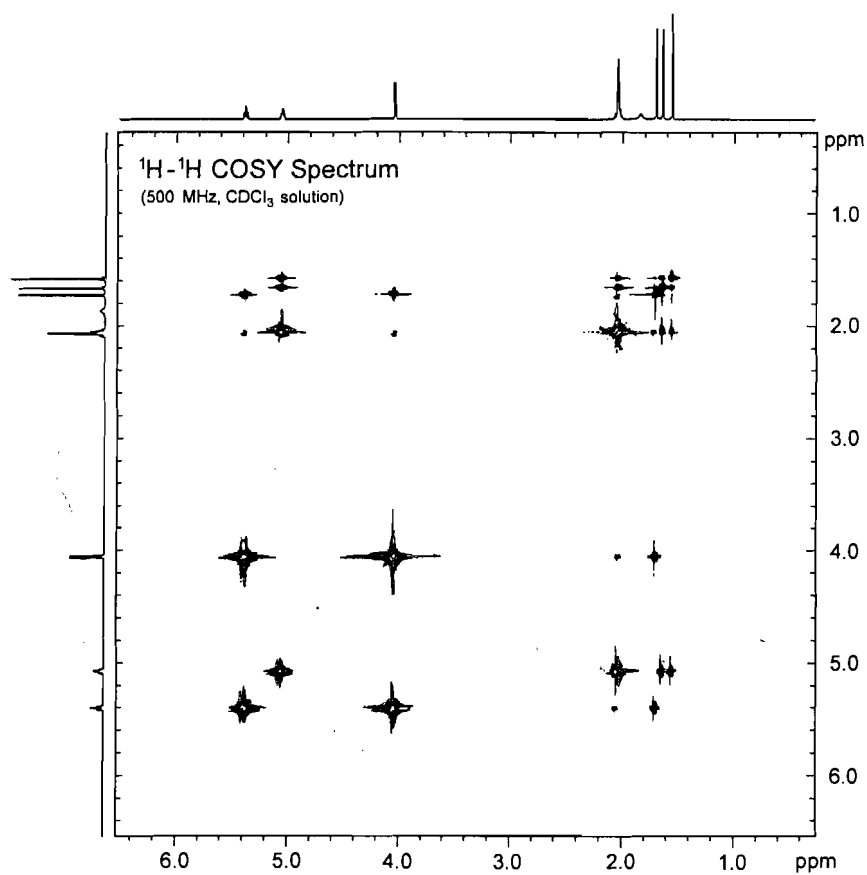



## Problem 309

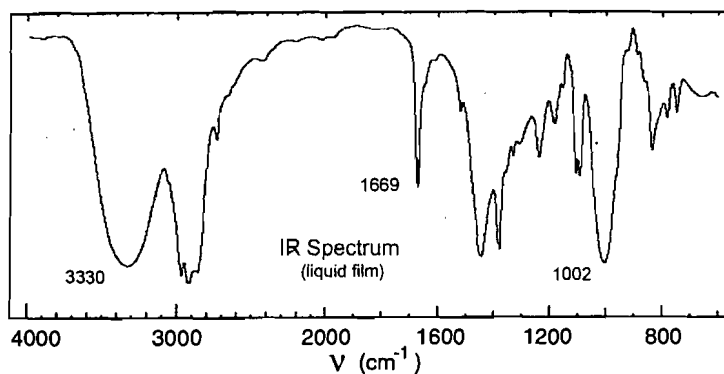

Use the basic spectral data plus the COSY and NOESY spectra on the facing page to deduce the structure, including stereochemistry of this compound.

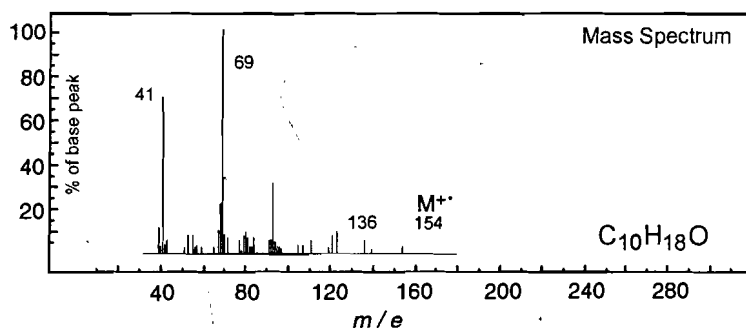

No significant UV absorption above 220 nm

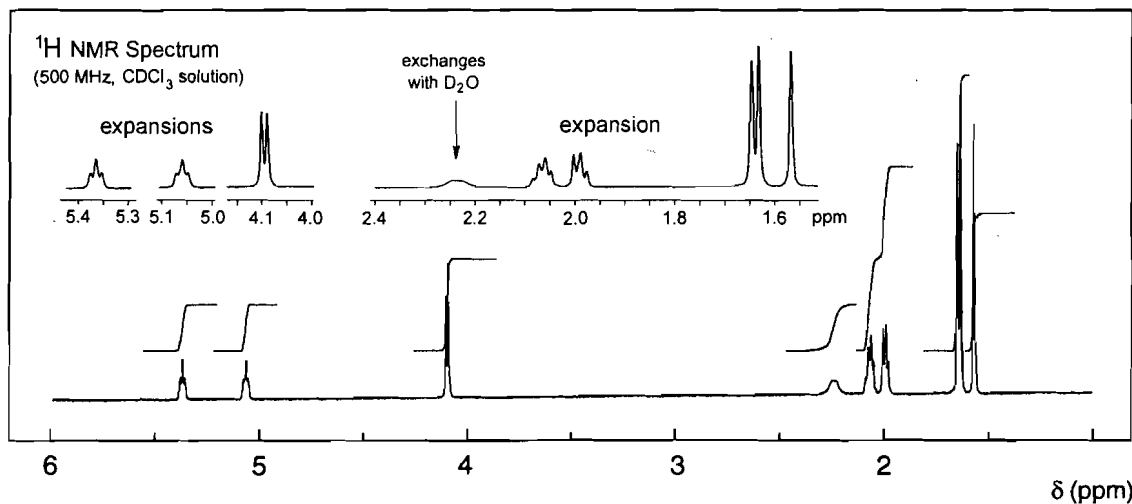
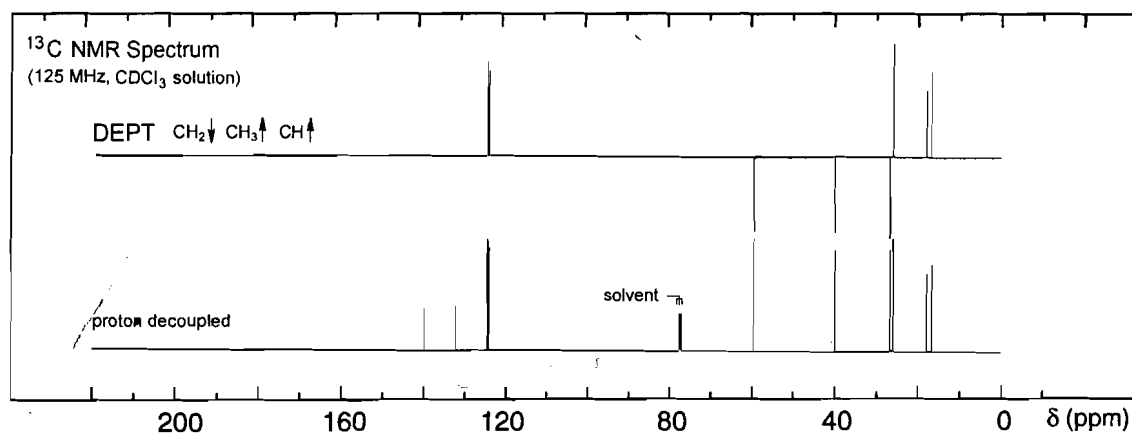

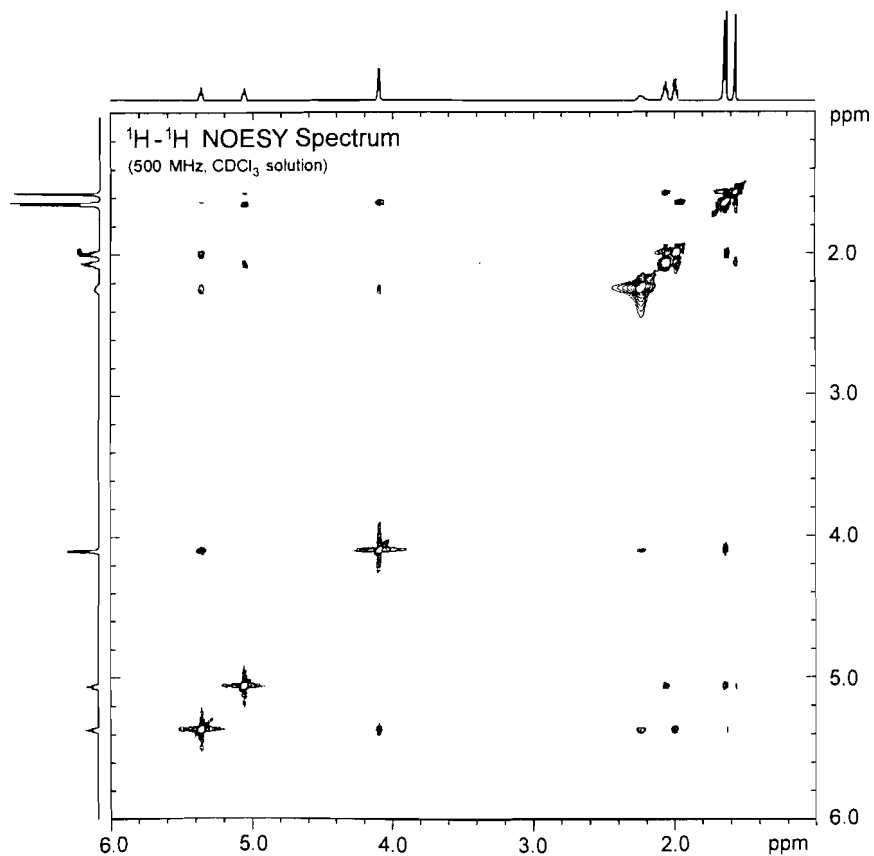
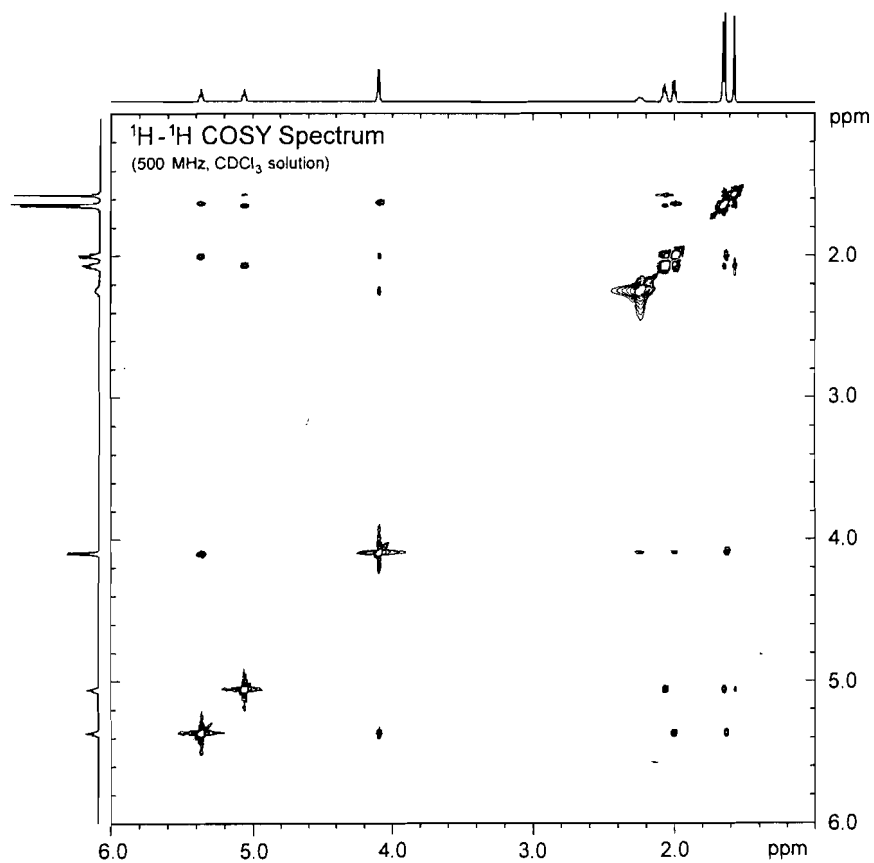





## 9.4

# NMR SPECTRAL ANALYSIS

---

## Problem 310

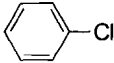
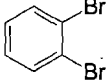
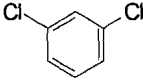
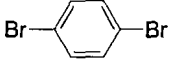
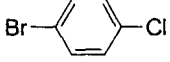
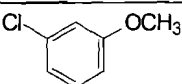
Give the number of different chemical environments for the magnetic nuclei  $^1\text{H}$  and  $^{13}\text{C}$  in the following compounds. Assume that any conformational processes are fast on the NMR timescale unless otherwise indicated.

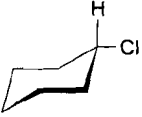
Structure	Number of $^1\text{H}$ environments	Number of $^{13}\text{C}$ environments
$\text{CH}_3-\text{CO}-\text{CH}_2\text{CH}_2\text{CH}_3$		
$\text{CH}_3\text{CH}_2-\text{CO}-\text{CH}_2\text{CH}_3$		
$\text{CH}_2=\text{CHCH}_2\text{CH}_3$		
<i>cis</i> - $\text{CH}_3\text{CH}=\text{CHCH}_3$		
<i>trans</i> - $\text{CH}_3\text{CH}=\text{CHCH}_3$		
		
		
		
		
		
		
		
 Assuming <b>slow</b> chair-chair interconversion		
 Assuming <b>fast</b> chair-chair interconversion		
 Assuming the molecule to be <i>conformationally rigid</i>		

## Problem 311

Draw a schematic (line) representation of the pure first-order spectrum (AMX) corresponding to the following parameters:

**Frequencies** (Hz from TMS):  $\nu_A = 300$ ;  $\nu_M = 240$ ;  $\nu_X = 120$ .

**Coupling constants** (Hz):  $J_{AM} = 10$ ;  $J_{AX} = 2$ ;  $J_{MX} = 8$ .

Assume that the spectrum is a pure first-order spectrum and ignore small distortions in relative intensities of lines that would be apparent in a "real" spectrum.

- Sketch in "splitting diagrams" above the schematic spectrum to indicate which splittings correspond to which coupling constants.
- Give the chemical shifts on the  $\delta$  scale corresponding to the above spectrum obtained with an instrument operating at 60 MHz for protons.

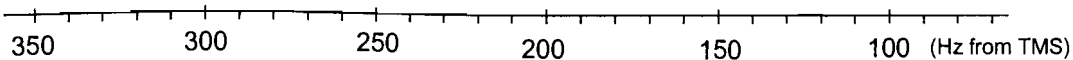

## Problem 312

Draw a schematic (line) representation of the pure first-order spectrum (AMX) corresponding to the following parameters:

**Frequencies** (Hz from TMS):  $\nu_A = 180$ ;  $\nu_M = 220$ ;  $\nu_X = 300$ .

**Coupling constants** (Hz):  $J_{AM} = 10$ ;  $J_{AX} = 12$ ;  $J_{MX} = 5$ .

Assume that the spectrum is a pure first-order spectrum and ignore small distortions in relative intensities of lines that would be apparent in a "real" spectrum.

- Sketch in "splitting diagrams" above the schematic spectrum to indicate which splittings correspond to which coupling constants.
- Give the chemical shifts on the  $\delta$  scale corresponding to the above spectrum obtained with an instrument operating at 200 MHz for protons.

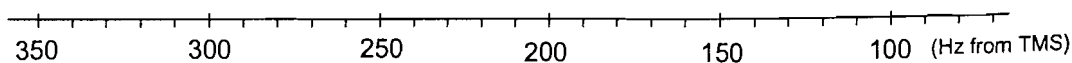

---

## Problem 313

Draw a schematic (line) representation of the pure first-order spectrum ( $AX_2$ ) corresponding to the following parameters:

**Frequencies** (Hz from TMS):  $\nu_A = 150$ ;  $\nu_X = 300$ .

**Coupling constants** (Hz):  $J_{AX} = 20$ .

Assume that the spectrum is a pure first-order spectrum and ignore small distortions in relative intensities of lines that would be apparent in a "real" spectrum.

- (a) Sketch in "splitting diagrams" above the schematic spectrum to indicate which splittings correspond to which coupling constants.
- (b) Give the chemical shifts on the  $\delta$  scale corresponding to the above spectrum obtained with an instrument operating at 400 MHz for protons.

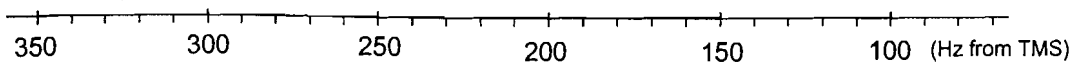



## Problem 314

A 60 MHz  $^1\text{H}$  NMR spectrum of diethyl ether is given below.

Note that the spectrum is calibrated only in parts per million (ppm) from tetramethylsilane (TMS), *i.e.* in  $\delta$  units.

- Assign the signals due to the  $-\text{CH}_2-$  and  $-\text{CH}_3$  groups respectively using three independent criteria (the relative areas of the signals, the multiplicity of each signal and the chemical shift of each signal).
- Obtain the chemical shift of each group in ppm, then convert to Hz at 60 MHz from TMS (see Section 5.4).
- Obtain the value of the first-order coupling constants  $^3J_{\text{H-H}}$  (in Hz).
- Demonstrate that first-order analysis was justified (see Section 5.6).

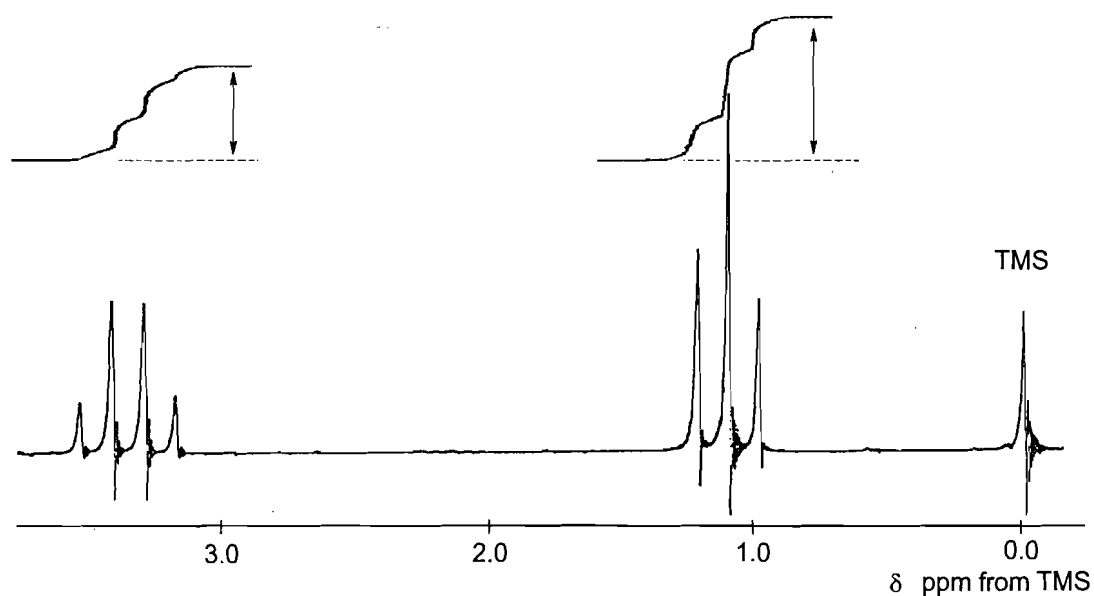

## Problem 315

A 100 MHz  $^1\text{H}$  NMR spectrum of a 3-proton system is given below.

- Draw a splitting diagram and analyse this spectrum by first-order methods, *i.e.* extract all relevant coupling constants ( $J$  in Hz) and chemical shifts ( $\delta$  in ppm) by direct measurement.
- Justify the use of a first-order analysis (see Section 5.6).

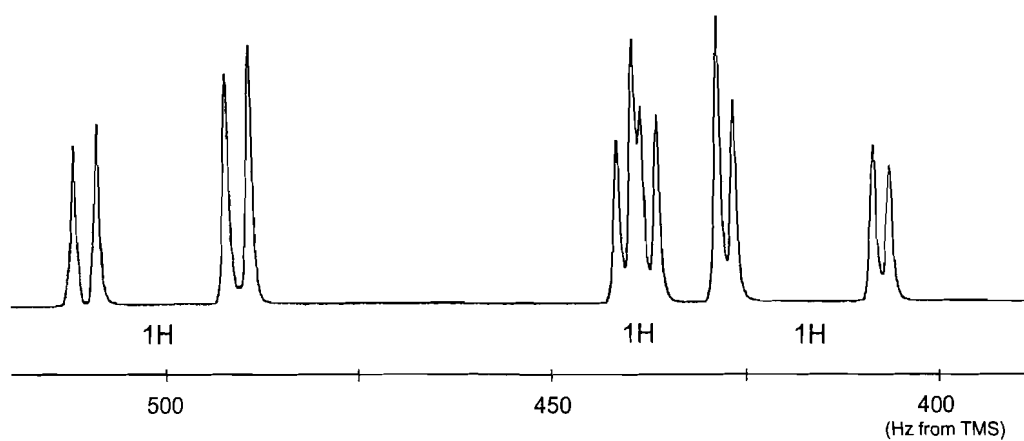

# Problem 316

Portion of the 60 MHz NMR spectrum 2-furoic acid in  $\text{CDCl}_3$  is shown below. Only the resonances due to the three aromatic protons ( $\text{H}_A$ ,  $\text{H}_M$  and  $\text{H}_X$ ) are shown.

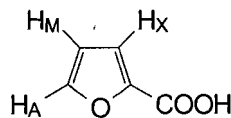

2-Furoic Acid

- (a) Draw a splitting diagram and analyse this spectrum by first-order methods, *i.e.* extract all relevant coupling constants ( $J$  in Hz) and chemical shifts ( $\delta$  in ppm) by direct measurement.
- (b) Justify the use of a first-order analysis (see Section 5.6).

**Note:** This is a 60 MHz spectrum.

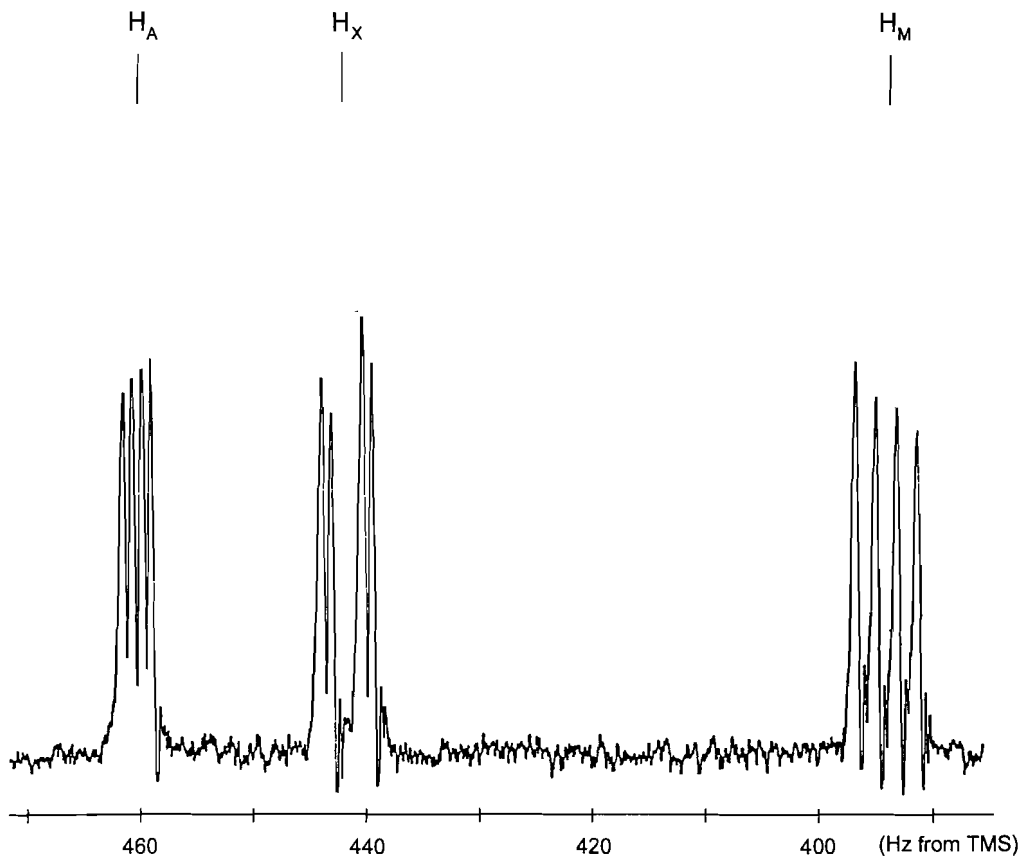

## Problem 317

A portion of the 100 MHz  $^1\text{H}$  NMR spectrum of 2-amino-5-chlorobenzoic acid in  $\text{CD}_3\text{OD}$  is given below. Only the resonances due to the three aromatic protons are shown.

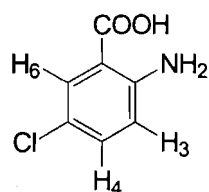

- (a) Draw a splitting diagram and analyse this spectrum by first-order methods, *i.e.* extract all relevant coupling constants ( $J$  in Hz) and chemical shifts ( $\delta$  in ppm) by direct measurement.
- (b) Justify the use of a first-order analysis (see Section 5.6).
- (c) Assign the three multiplets to  $\text{H}_3$ ,  $\text{H}_4$  and  $\text{H}_6$  given:
- the characteristic ranges for coupling constants between aromatic protons (see Section 5.7);
  - the fact that  $\text{H}_3$  will give rise to the resonance at the highest field due to the strong influence of the amino group (see Table 5.6).

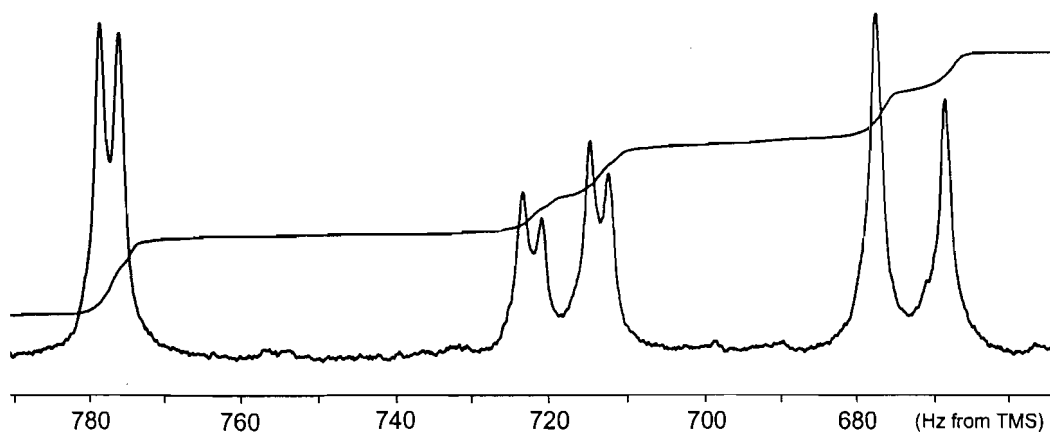

## Problem 318a

Portion of 100 MHz  $^1\text{H}$  NMR spectrum of methyl acrylate (5% in  $\text{C}_6\text{D}_6$ ) is given below. Only the part of the spectrum containing the resonances of the olefinic protons  $\text{H}_\text{A}$ ,  $\text{H}_\text{B}$  and  $\text{H}_\text{C}$  is shown.

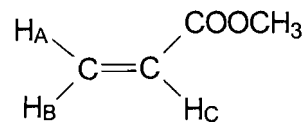

methyl acrylate

- Draw a splitting diagram.
- Analyse this spectrum by first-order methods, *i.e.* extract all relevant coupling constants ( $J$  in Hz) and chemical shifts ( $\delta$  in ppm) by direct measurement.
- Justify the statement that "this spectrum is really a borderline second-order (strongly coupled) case". Point out the most conspicuous deviation from first-order character in this spectrum (see Section 5.6).
- Assign the three multiplets to  $\text{H}_\text{A}$ ,  $\text{H}_\text{B}$  and  $\text{H}_\text{C}$  on the basis of coupling constants only (see Section 5.7).

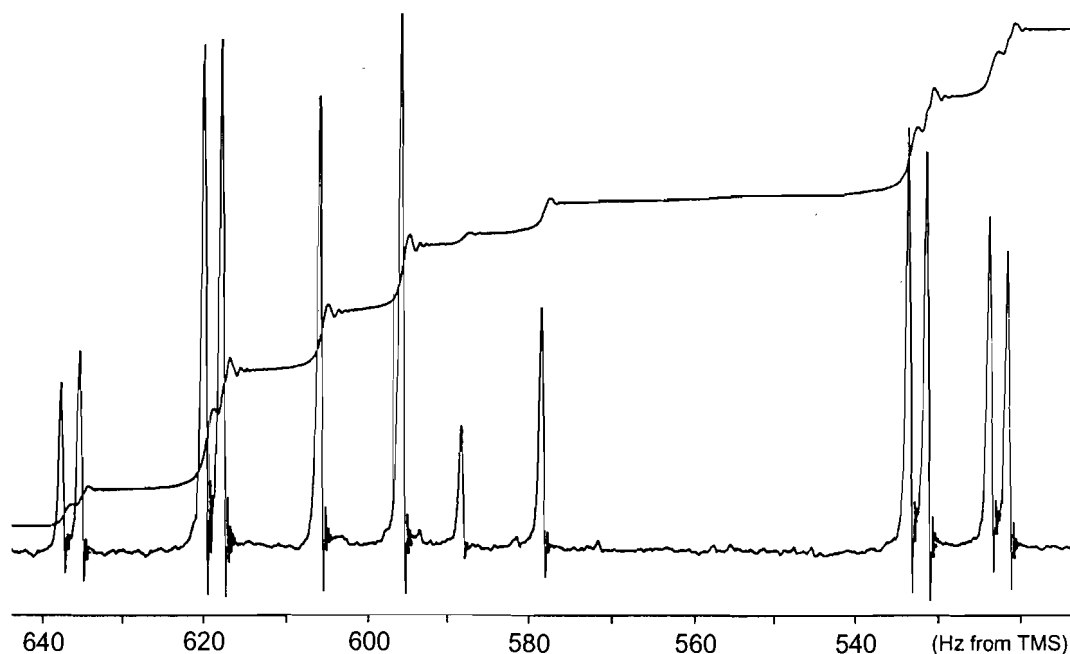

## Problem 318b

This is the **computer-simulated spectrum** corresponding to the complete analysis of the spectrum shown in Problem 318a, *i.e.* an exact analysis in which first-order assumptions were not made. The simulated spectrum fits the experimental spectrum, verifying that the analysis was correct. Compare your (first-order) results from Problem 318a with the actual solution given here.

Number of SPINS = 3  
 F(1) = + 528.500 Hz  
 F(2) = + 594.531 Hz  
 F(3) = + 626.093 Hz

J(1,2) = + 10.539 Hz  
 J(1,3) = + 1.589 Hz  
 J(2,3) = + 17.278 Hz

START of simulation = + 750.000 Hz  
 FINISH of simulation = + 500.000 Hz  
 LINE WIDTH = + 0.427 Hz

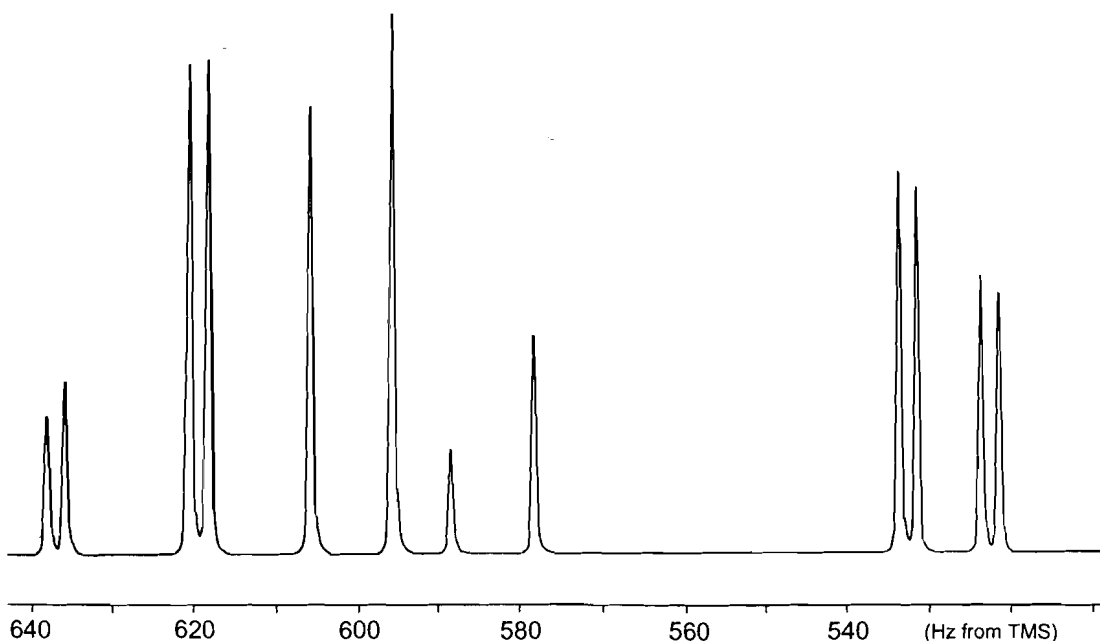

---

## Problem 319

Draw a schematic (line) representation of the pure first-order spectrum ( $AX_3$ ) corresponding to the following parameters:

**Frequencies** (Hz from TMS):  $\nu_A = 160$ ;  $\nu_X = 280$ .

**Coupling constants** (Hz):  $J_{AX} = 15$ .

Assume that the spectrum is a pure first-order spectrum and ignore small distortions in relative intensities of lines that would be apparent in a "real" spectrum.

- (a) Sketch in "splitting diagrams" above the schematic spectrum to indicate which splittings correspond to which coupling constants.
- (b) Give the chemical shifts on the  $\delta$  scale corresponding to the above spectrum obtained with an instrument operating at 60 MHz for protons.

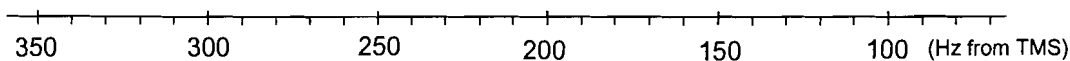

## Problem 320

A 100 MHz  $^1\text{H}$  NMR spectrum of a 4-proton system is given below.

- Draw a splitting diagram.
- Analyse this spectrum by first-order methods, *i.e.* extract all relevant coupling constants ( $J$  in Hz) and chemical shifts ( $\delta$  in ppm) by direct measurement.
- Justify the use of first-order analysis (see Section 5.6).

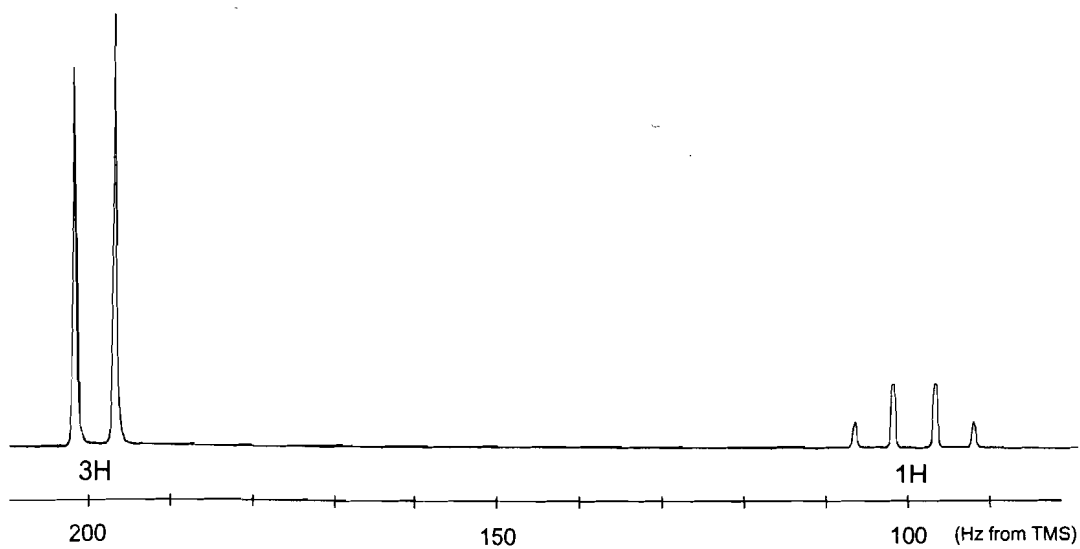



---

## Problem 321

Draw a schematic (line) representation of the pure first-order spectrum ( $AMX_2$ ) corresponding to the following parameters:

**Frequencies** (Hz from TMS):  $\nu_A = 340$ ;  $\nu_M = 240$ ;  $\nu_X = 100$ .

**Coupling constants** (Hz):  $J_{AM} = 10$ ;  $J_{AX} = 2$ ;  $J_{MX} = 6$ .

Assume that the spectrum is a pure first-order spectrum and ignore small distortions in relative intensities of lines that would be apparent in a "real" spectrum.

- Sketch in "splitting diagrams" above the schematic spectrum to indicate which splittings correspond to which coupling constants.
- Give the chemical shifts on the  $\delta$  scale corresponding to the above spectrum obtained with an instrument operating at 60 MHz for protons.

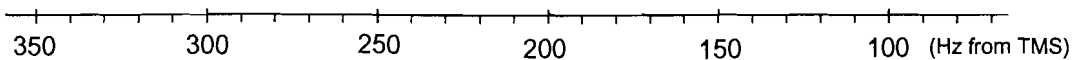

## Problem 322

Draw a schematic (line) representation of the pure first-order spectrum ( $AM_2X$ ) corresponding to the following parameters:

**Frequencies** (Hz from TMS):  $\nu_A = 110$ ;  $\nu_M = 200$ ;  $\nu_X = 290$ .

**Coupling constants** (Hz):  $J_{AM} = 10$ ;  $J_{AX} = 12$ ;  $J_{MX} = 3$ .

Assume that the spectrum is a pure first-order spectrum and ignore small distortions in relative intensities of lines that would be apparent in a "real" spectrum.

- Sketch in "splitting diagrams" above the schematic spectrum to indicate which splittings correspond to which coupling constants.
- Give the chemical shifts on the  $\delta$  scale corresponding to the above spectrum obtained with an instrument operating at 60 MHz for protons.

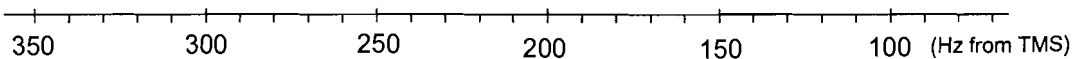

## Problem 323

A 100 MHz  $^1\text{H}$  NMR spectrum of a 4-proton system is given below.

- Draw a splitting diagram.
- Analyse this spectrum by first-order methods, *i.e.* extract all relevant coupling constants ( $J$  in Hz) and chemical shifts ( $\delta$  in ppm) by direct measurement.
- Justify the use of first-order analysis (see Section 5.6).

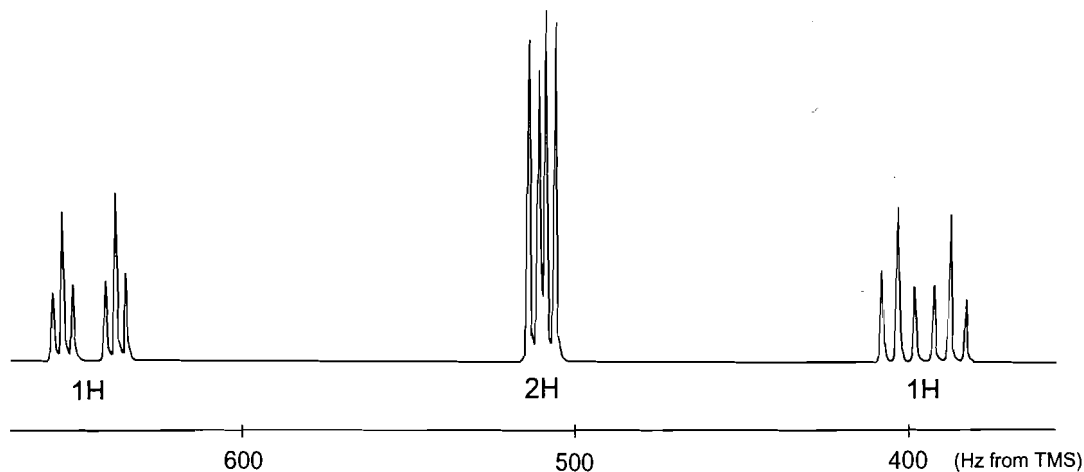

## Problem 324

A 100 MHz  $^1\text{H}$  NMR spectrum of a 4-proton system is given below.

- Draw a splitting diagram.
- Analyse this spectrum by first-order methods, *i.e.* extract all relevant coupling constants ( $J$  in Hz) and chemical shifts ( $\delta$  in ppm) by direct measurement.
- Justify the use of first-order analysis (see Section 5.6).

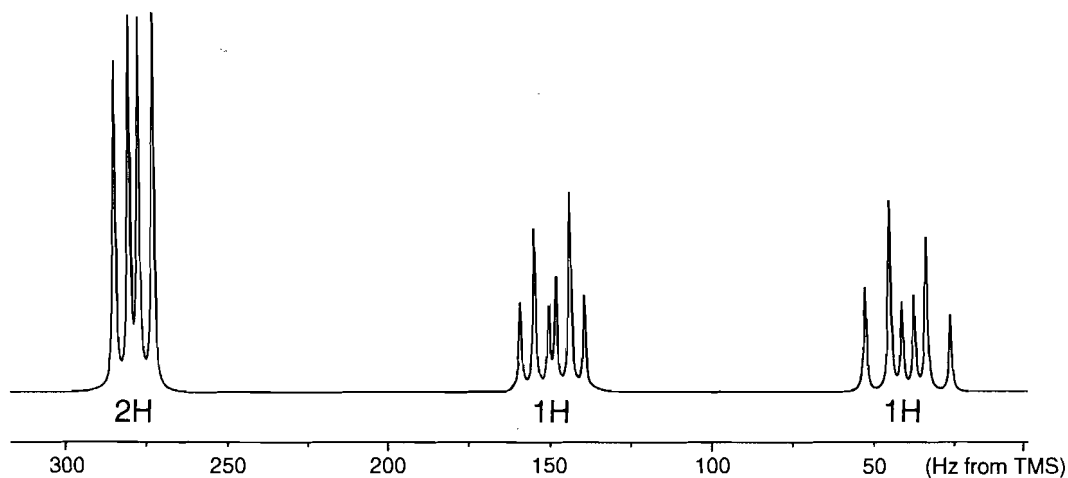

## Problem 325

A 100 MHz  $^1\text{H}$  NMR spectrum of a 4-proton system is given below.

- Draw a splitting diagram.
- Analyse this spectrum by first-order methods, *i.e.* extract all relevant coupling constants ( $J$  in Hz) and chemical shifts ( $\delta$  in ppm) by direct measurement.
- Justify the use of first-order analysis (see Section 5.6).

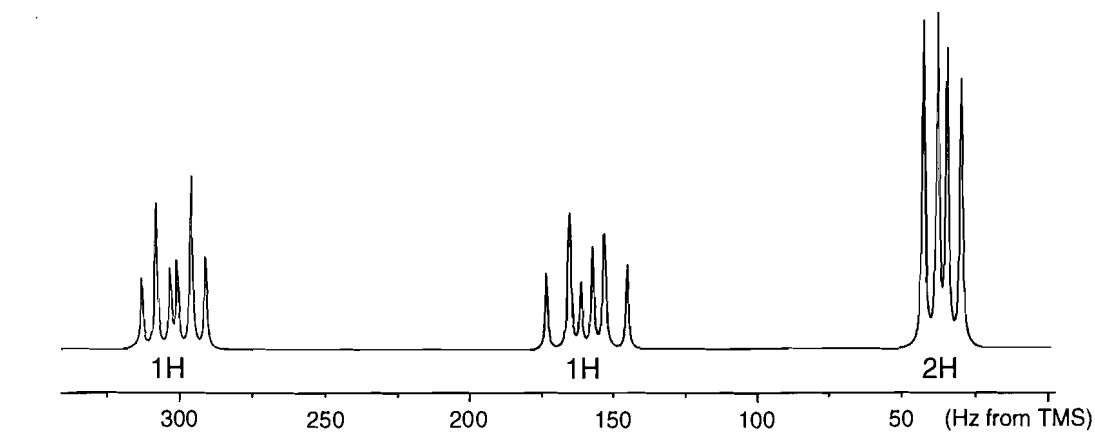

## Problem 326

A 200 MHz  $^1\text{H}$  NMR spectrum of a 5-proton system is given below.

- Draw a splitting diagram.
- Analyse this spectrum by first-order methods, *i.e.* extract all relevant coupling constants ( $J$  in Hz) and chemical shifts ( $\delta$  in ppm) by direct measurement.
- Justify the use of first-order analysis (see Section 5.6).

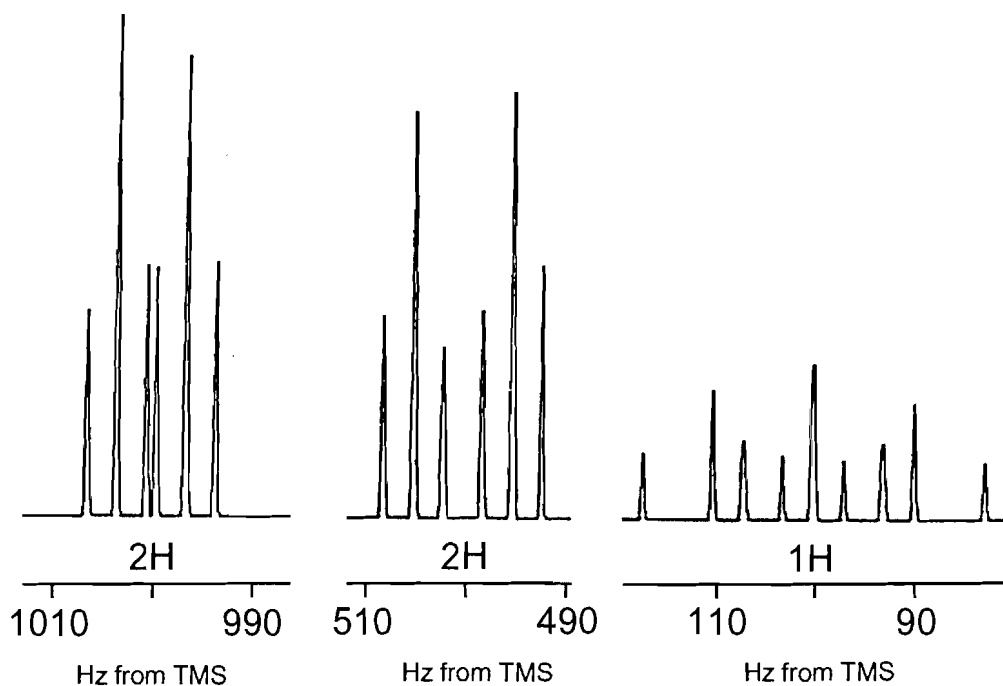

## Problem 327

Portion of 100 MHz NMR spectrum of crotonic acid in  $\text{CDCl}_3$  is given below. The upfield part of the spectrum, which is due to the methyl group, is less amplified to fit the page.

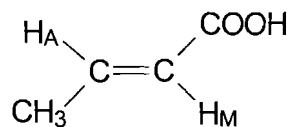

crotonic acid

- (a) Draw a splitting diagram and analyse this spectrum by first-order methods, *i.e.* extract all relevant coupling constants ( $J$  in Hz) and chemical shifts ( $\delta$  in ppm) by direct measurement. Justify the use of first-order analysis.
- (b) There are certain conventions used for naming spin-systems (*e.g.* AMX,  $\text{AMX}_2$ ,  $\text{AM}_2\text{X}_3$ ). Note that this is a *5-spin system* and name the spin system responsible for this spectrum (see Section 5.6).

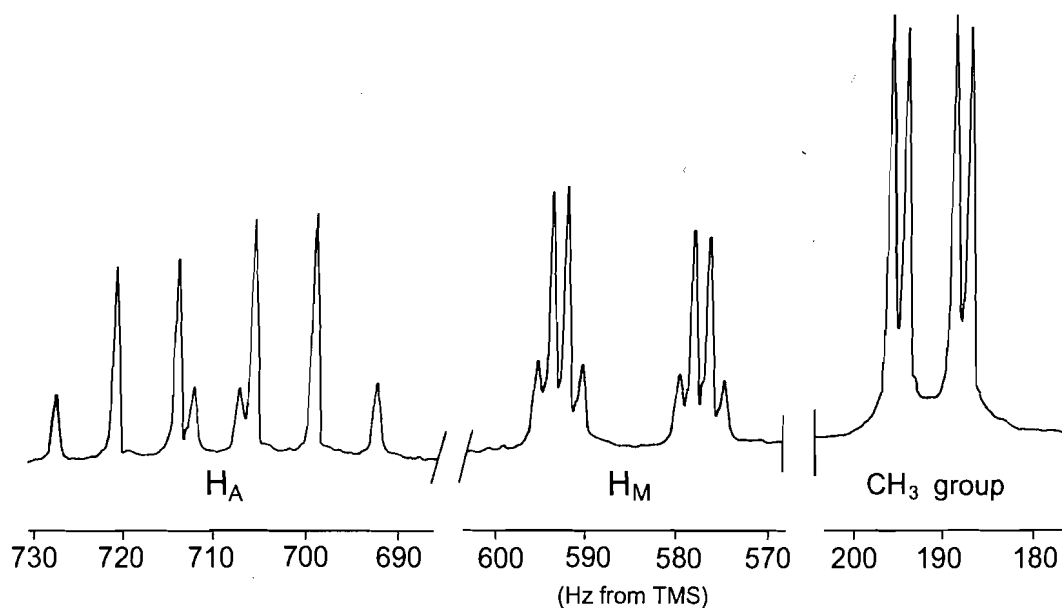

## Problem 328

The 100 MHz  $^1\text{H}$  NMR spectrum (5% in  $\text{CDCl}_3$ ) of an  $\alpha,\beta$ -unsaturated aldehyde  $\text{C}_4\text{H}_6\text{O}$  is given below.

- Draw a splitting diagram and analyse this spectrum by first-order methods, *i.e.* extract all relevant coupling constants ( $J$  in Hz) and chemical shifts ( $\delta$  in ppm) by direct measurement.
- Justify the use of a first-order analysis (see Section 5.6).
- Use the coupling constants to obtain the structure of the compound, including the stereochemistry about the double bond (see Section 5.7).

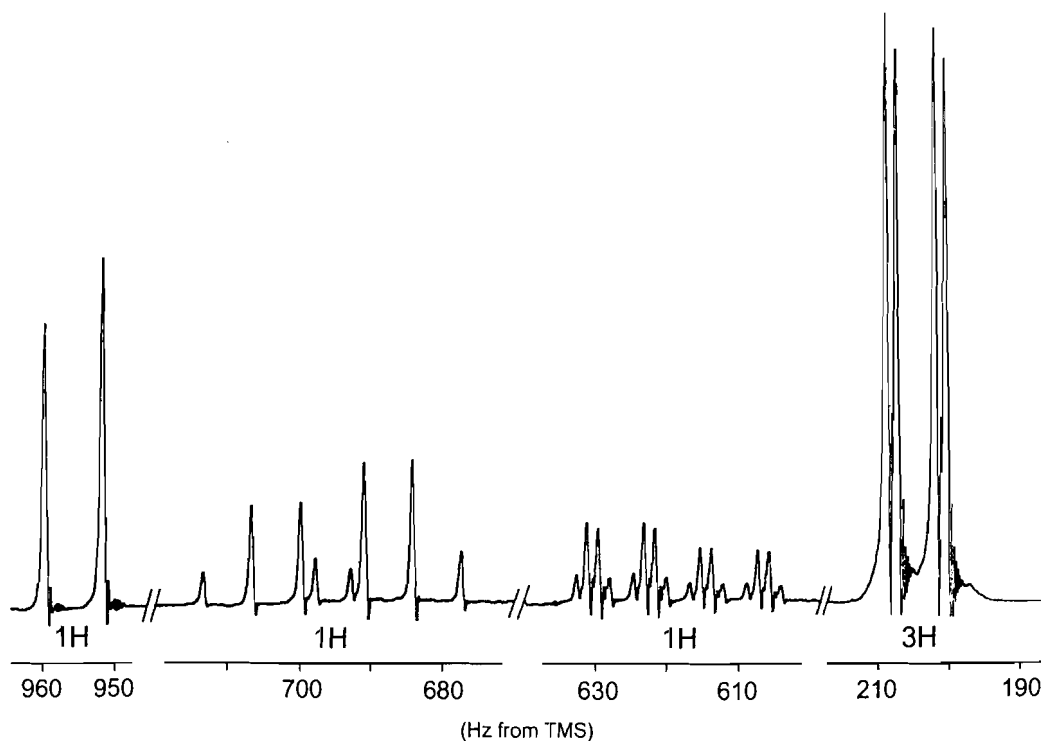



## Problem 329

Draw a schematic (line) representation of the pure first-order spectrum ( $AMX_3$ ) corresponding to the following parameters:

**Frequencies** (Hz from TMS):  $\nu_A = 80$ ;  $\nu_M = 220$ ;  $\nu_X = 320$ .

**Coupling constants** (Hz):  $J_{AM} = 10$ ;  $J_{AX} = 12$ ;  $J_{MX} = 0$ .

Assume that the spectrum is a pure first-order spectrum and ignore small distortions in relative intensities of lines that would be apparent in a "real" spectrum.

- Sketch in "splitting diagrams" above the schematic spectrum to indicate which splittings correspond to which coupling constants.
- Give the chemical shifts on the  $\delta$  scale corresponding to the above spectrum obtained with an instrument operating at 60 MHz for protons.

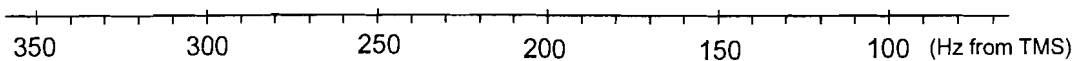

## Problem 330

A portion of the 90 MHz  $^1\text{H}$  NMR spectrum (5% in  $\text{CDCl}_3$ ) of one of the six possible isomeric dibromoanilines is given below. Only the resonances of the aromatic protons are shown.

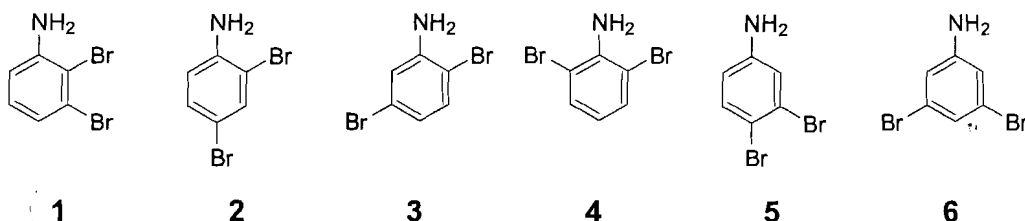

Determine which is the correct structure for this compound using arguments based on symmetry and the magnitudes of spin-spin coupling constants (see Section 5.7).

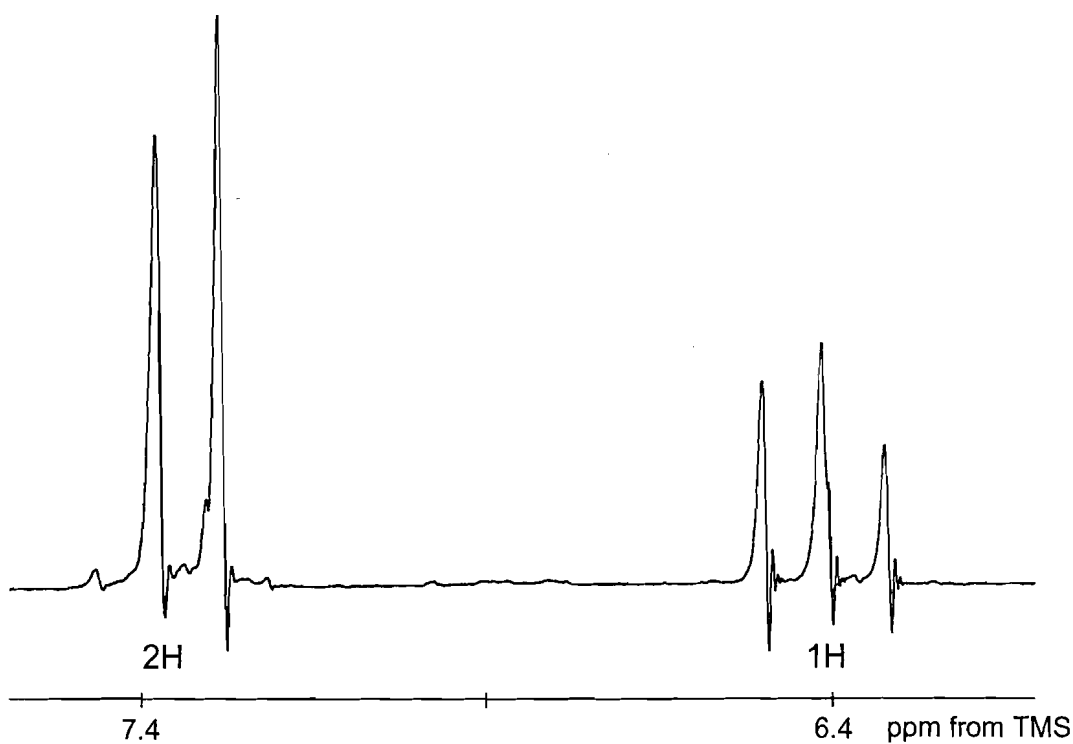



## Problem 332

In a published paper, the 90 MHz  $^1\text{H}$  NMR spectrum given below was assigned to 1,5-dichloronaphthalene,  $\text{C}_{10}\text{H}_6\text{Cl}_2$ .

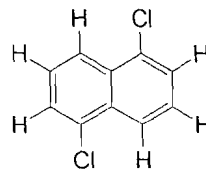

1,5-dichloronaphthalene

- (a) Why can't this spectrum belong to 1,5-dichloronaphthalene?
- (b) Suggest two alternative dichloronaphthalenes that would have structures consistent with the spectrum given.

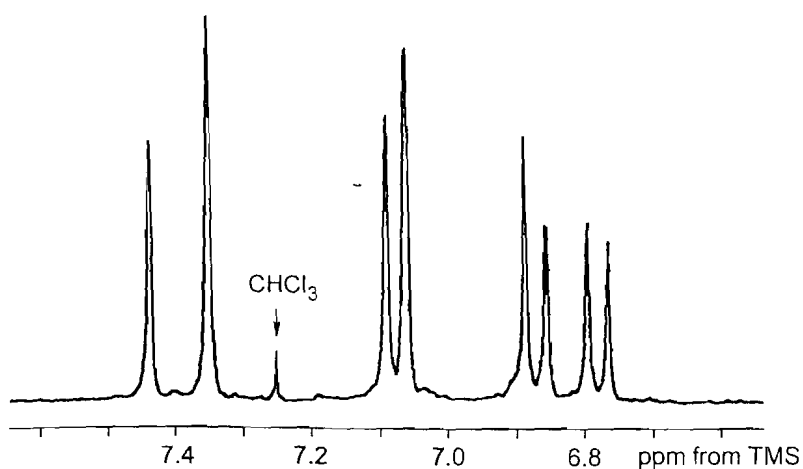

# Appendix

---

## WORKED EXAMPLES

This section works through two problems from the text to indicate a reasonable process for obtaining the structure of the unknown compound from the spectra provided. It should be emphasised that the logic used here is by no means the only way to arrive at the correct solution but it does provide a systematic approach to obtaining structures by assembling structural fragments identified by each type of spectroscopy.

### A1 PROBLEM 91

#### (1) *Perform all Routine Operations*

- (a) From the molecular ion, the molecular weight is 198/200. The molecular ion has two peaks of equal intensity separated by two mass units. This is the characteristic pattern for a compound containing one bromine atom.
- (b) The molecular formula is  $C_9H_{11}Br$  so one can determine the degree of unsaturation (see Section 1.3). Replace the Br by H to give an effective molecular formula of  $C_9H_{12}$  ( $C_nH_m$ ) which gives the degree of unsaturation as  $(n - m/2 + 1) = 9 - 6 + 1 = 4$ . The compound must contain the equivalent of 4  $\pi$  bonds and/or rings. This degree of unsaturation would be consistent with one aromatic ring (with no other elements of unsaturation).
- (c) The total integral across all peaks in the  $^1H$  spectrum is 43 mm. From the molecular formula, there are 11 protons in the structure so this corresponds to 3.9 mm per proton. The relative numbers of protons in different environments:

$\delta$ $^1H$ (ppm)	Integral (mm)	Relative No. of hydrogens (rounded)
~ 7.2	19	4.9 (5H)
~ 3.3	8	2 (2H)
~ 2.8	8	2 (2H)
~ 2.2	8	2 (2H)

Note that this analysis gives a total of  $5+2+2+2 = 11$  protons which is consistent with the molecular formula provided.

- (d) From the  $^{13}\text{C}$  spectrum there are 7 carbon environments: 4 carbons are in the typical aromatic/olefinic chemical shift range and 3 carbons in the aliphatic chemical shift range. The molecular formula is  $\text{C}_9\text{H}_{11}\text{Br}$  so there must be an element (or elements) of symmetry to account for the 2 carbons not apparent in the  $^{13}\text{C}$  spectrum.
- (e) From the  $^{13}\text{C}$  DEPT spectrum there are 3 CH resonances in the aromatic/olefinic chemical shift range and 3  $\text{CH}_2$  carbons in the aliphatic chemical shift range
- (f) Calculate the extinction coefficient from the UV spectrum:

$$\epsilon_{255} = \frac{199 \times 0.95}{0.53 \times 1.0} = 357$$

(2) **Identify any Structural Elements**

- (a) There is no useful additional information from infrared spectrum.
- (b) In the mass spectrum there is a strong fragment at  $m/e = 91$  and this indicates a possible  $\text{Ph-CH}_2$ - group.
- (c) The ultraviolet spectrum shows a typical benzenoid absorption without further conjugation or auxochromes. This would also be consistent with the  $\text{Ph-CH}_2$ - group.
- (d) From the  $^{13}\text{C}$  NMR spectrum, there is one resonance in the  $^{13}\text{C}\{^1\text{H}\}$  spectrum which does not appear in the  $^{13}\text{C}$  DEPT spectrum. This indicates one quaternary (non-protonated) carbon. There are 4 resonances in the aromatic region, 3 x CH and 1 x quaternary carbon, which is typical of a monosubstituted benzene ring.
- (e) From the  $^1\text{H}$  NMR, there are 5 protons near  $\delta \sim 7.2$  which strongly suggests a monosubstituted benzene ring, consistent with (b), (c) and (d). The  $\text{Ph-CH}_2$ - group is confirmed.

The triplet at approximately  $\delta$  3.3 ppm of intensity 2H suggests a  $\text{CH}_2$  group. The downfield chemical shift suggests a  $-\text{CH}_2\text{-X}$  group with X being an electron withdrawing group (probably bromine). The triplet splitting indicates that there must be another  $\text{CH}_2$  as a neighbouring group. In the expanded proton spectrum 1 ppm = 42 mm and since this is a 200 MHz NMR spectrum, therefore 200 Hz = 42 mm. The triplet spacing is measured to be 1.5 mm *i.e.* 7.1 Hz and this is typical of vicinal coupling ( $^3J_{\text{HH}}$ ).

The triplet at approximately  $\delta$  2.8 ppm of intensity 2H in the  $^1\text{H}$  NMR spectrum suggests a  $\text{CH}_2$  with one  $\text{CH}_2$  as a neighbour. The spacing of this triplet is almost identical with that observed for the triplet near  $\delta$  3.3 ppm.

The quintet at approximately  $\delta$  2.2 ppm. of intensity 2H has the same spacings as observed in the triplets near  $\delta$  2.8 and  $\delta$  3.3 ppm. This signal is consistent with a  $\text{CH}_2$  group coupled to *two* flanking  $\text{CH}_2$  groups. A sequence  $-\text{CH}_2\text{-CH}_2\text{-CH}_2-$  emerges in agreement with the  $^{13}\text{C}$  data.

Thus the structural elements are:

1. Ph-CH<sub>2</sub>-
2. -CH<sub>2</sub>-CH<sub>2</sub>-CH<sub>2</sub>-
3. -Br

**(3) Assemble the Structural Elements**

Clearly there must be some common segments in these structural elements since the total number of C and H atoms adds to more than is indicated in the molecular formula. One of the CH<sub>2</sub> groups in structural element (2) must be the benzylic CH<sub>2</sub> group of structural element (1).

The structural elements can be assembled in only one way and this identifies the compound as 1-bromo-3-phenylpropane.

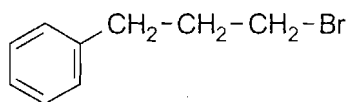

**(4) Check that the answer is consistent with all spectra.**

There are no additional strong fragments in the mass spectrum.

In the infrared spectrum there are two strong absorptions between 600 and 800 cm<sup>-1</sup> which are consistent with the C-Br stretch of alkyl bromide.

## A2 PROBLEM 121

## (I) Perform all Routine operations

- (a) The molecular formula is given as  $C_9H_{11}NO_2$ . The molecular ion in the mass spectrum gives the molecular weight as 165.
- (b) From the molecular formula,  $C_9H_{11}NO_2$ , determine the degree of unsaturation (see Section 1.3). Ignore the O atoms and ignore the N and remove one H to give an effective molecular formula of  $C_9H_{10}$  ( $C_nH_m$ ) which gives the degree of unsaturation as  $(n - m/2 + 1) = 9 - 5 + 1 = 5$ . The compound must contain the equivalent of 5  $\pi$  bonds and/or rings. This degree of unsaturation would be consistent with one aromatic ring with one other ring or double bond.
- (c) The total integral across all peaks in the  $^1H$  spectrum is 54 mm. From the molecular formula, there are 11 protons in the structure so this corresponds to 4.9 mm per proton. The relative numbers of protons in different environments:

$\delta$ $^1H$ (ppm)	Integral (mm)	Relative No. of hydrogens (rounded)
~ 7.9	9	1.8 (2H)
~ 6.6	10	2 (2H)
~ 4.3	10	2 (2H)
~ 4.0	10	2 (2H)
~ 1.4	15	3 (3H)

Note that this analysis gives a total of  $2+2+2+2+3 = 11$  protons which is consistent with the molecular formula provided.

- (d) From the  $^{13}C$  spectrum there are 7 carbon environments: 4 carbons are in the typical aromatic/olefinic chemical shift range, 2 carbons in the aliphatic chemical shift range and 1 carbon at low field (167 ppm) characteristic of a carbonyl carbon. The molecular formula is given as  $C_9H_{11}NO_2$  so there must be an element (or elements) of symmetry to account for the 2 carbons not apparent in the  $^{13}C$  spectrum.
- (e) From the  $^{13}C$  off-resonance decoupled spectrum there are 2 CH resonances in the aromatic/olefinic chemical shift range, one  $CH_2$  and one  $CH_3$  carbon in the aliphatic chemical shift range.
- (f) Calculate the extinction coefficient from the UV spectrum:

$$\epsilon_{292} = \frac{165 \times 0.90}{0.0172 \times 0.5} = 17,267$$



(2) *Identify any Structural Elements*

- (a) From the infrared spectrum, there is a strong absorption at  $1680\text{ cm}^{-1}$  and this is probably a C=O stretch at an unusually low frequency (such as an amide or strongly conjugated ketone).
- (b) In the mass spectrum there are no obvious fragment peaks, but the difference between 165 (M) and  $137 = 28$  suggests loss of ethylene ( $\text{CH}_2=\text{CH}_2$ ) or CO.
- (c) In the UV spectrum, the presence of extensive conjugation is apparent from the large extinction coefficient ( $\epsilon \approx 17,000$ ).
- (d) In the  $^1\text{H}$  NMR spectrum:

The appearance of a 4 proton symmetrical pattern in the aromatic region near  $\delta$  7.9 and 6.6 ppm is strongly indicative of a *para* disubstituted benzene ring. This is confirmed by the presence of two quaternary  $^{13}\text{C}$  resonances at  $\delta$  152 and 119 ppm in the  $^{13}\text{C}$  spectrum and two CH  $^{13}\text{C}$  resonances at  $\delta$  131 and 113 ppm.

Note that the presence of a *para* disubstituted benzene ring also accounts for the element of symmetry identified above. The triplet of 3H intensity at approximately  $\delta \sim 1.4$  and the quartet of 2H intensity at approximately  $\delta \sim 4.3$  have the same spacings of 1.1 mm. On this 100 MHz NMR spectrum, 100 Hz (1 ppm) corresponds to 16.5 mm so the measured splitting of 1.1 mm corresponds to a coupling of 6.7 Hz that is typical of a vicinal coupling constant. The triplet and quartet clearly correspond to an ethyl group and the downfield shift of the  $\text{CH}_2$  resonance ( $\delta \sim 4.3$ ) indicates that it must be attached to a heteroatom so this is possibly an  $-\text{O}-\text{CH}_2-\text{CH}_3$  group.

- (e) In the  $^{13}\text{C}$  NMR spectrum:

The signals at  $\delta$  14 ( $\text{CH}_3$ ) and  $\delta$  60 ( $\text{CH}_2$ ) in the  $^{13}\text{C}$  NMR spectrum confirm the presence of the ethoxy group and the 4 resonances in the aromatic region (2 x CH and 2 x quaternary carbons) confirm the presence of a *p*-disubstituted benzene ring.

The quaternary carbon signal at  $\delta$  167 ppm in the  $^{13}\text{C}$  NMR spectrum indicates an ester or an amide carbonyl group.

The following structural elements have been identified so far:

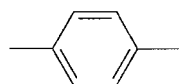

ethoxy group



carbonyl group



In total this accounts for  $\text{C}_9\text{H}_9\text{O}_2$  and this differs from the given molecular formula only by  $\text{NH}_2$ . The presence of an  $-\text{NH}_2$  group is confirmed by the exchangeable signal at  $\delta \sim 4.0$  in the  $^1\text{H}$  NMR spectrum and the

characteristic N-H stretching vibrations at 3200 - 3350  $\text{cm}^{-1}$  in the IR spectrum.

- (f) The presence of one aromatic ring plus the double bond in the carbonyl group is consistent with the calculated degree of unsaturation – there can be no other rings or multiple bonds in the structure.

### (3) Assemble the Structural Elements

The structural elements:

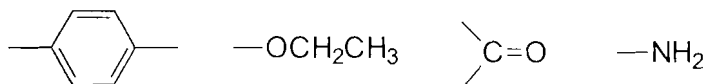

can be assembled as either as:

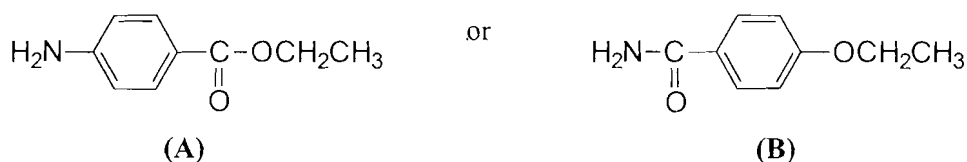

These possibilities can be distinguished because:

- (a) The **amine**  $-\text{NH}_2$  group in (A) is “exchangeable with  $\text{D}_2\text{O}$ ” as stated in the data but the **amide**  $-\text{NH}_2$  group in (B) would require heating or base catalysis.
- (b) From Table 5.4, the  $^1\text{H}$  chemical shift of the  $-\text{O}-\text{CH}_2-$  group fits better to the ester structure in (A) than the phenoxy ether structure in (B) given the models:

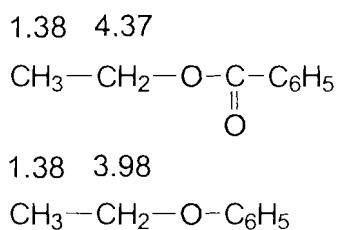

- (c) The  $^{13}\text{C}$  chemical shifts of the quaternary carbons in the aromatic ring are at approximately 152 and 119 ppm. From Table 6.7, these shifts would be consistent with a  $-\text{NH}_2$  and an ester substituent on an aromatic ring (structure A) but for an  $-\text{OEt}$  substituent (as in structure B), the *ipso* carbon would be expected at much lower field (between 160 and 170 ppm). The  $^{13}\text{C}$  chemical shifts are consistent with structure (A).

- (d) The fragmentation pattern in the mass spectrum shown below fits (A) but not (B). The key fragments at  $m/e$  137, 120 and 92 can be rationalised only from (A). This is decisive and ethyl 4-aminobenzoate (A) must be the correct answer.

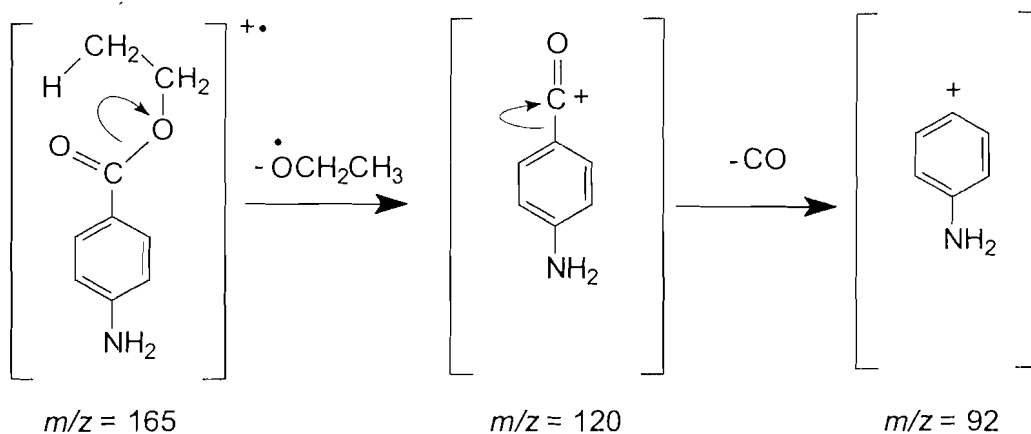
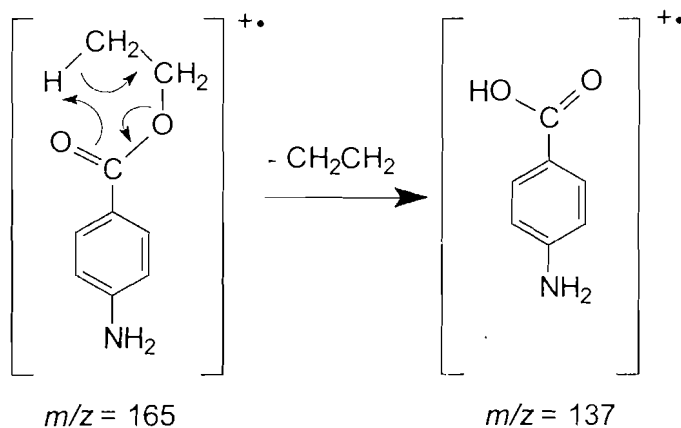

# Subject Index

---

<b>Key:</b>	<sup>13</sup> C NMR = Carbon 13 nuclear magnetic resonance spectrometry		
	<sup>1</sup> H NMR = Proton nuclear magnetic resonance spectrometry		
	2D NMR = 2-dimensional NMR		
	IR = Infrared spectroscopy		
	MS = Mass spectrometry		
	UV = Ultraviolet spectroscopy		
Absorbance, molar	8, 9	Anion Radical, MS	21
Aldehydes		Anisotropy, magnetic, NMR	47, 48
<sup>13</sup> C NMR	71	Appearance potential, MS	21
<sup>1</sup> H NMR	43, 44	Aromatic compounds	
IR	18	<sup>13</sup> C NMR	71, 74
Alkanes		<sup>1</sup> H NMR	44, 46, 47
<sup>13</sup> C NMR	71, 72	polynuclear	46, 74
<sup>1</sup> H NMR	44, 61	UV	13
Alkenes		Aromatic Solvent Induced Shift	84
<sup>13</sup> C NMR	71, 72	(ASIS)	
<sup>1</sup> H NMR	44, 45, 62	Auxochrome,	10, 13
IR	19, 20	Base peak, MS	24
UV	11	Bathochromic shift, UV	10
Alkynes		Beer-Lambert Law	2, 8
<sup>13</sup> C NMR	71, 73	Boltzmann excess, NMR	35
<sup>1</sup> H NMR	44	Cation radical, MS	21, 22
IR	19, 20	Carbonyl compounds	
Allenes		<sup>13</sup> C NMR	71-74
<sup>13</sup> C NMR	70	IR	18
IR	20	MS	31, 32
Amides		UV	12
<sup>13</sup> C NMR	71	Carboxylic acids	
<sup>1</sup> H NMR	44, 49, 77	<sup>13</sup> C NMR	71
IR	18	<sup>1</sup> H NMR	44, 49
Amines		IR	18
<sup>1</sup> H NMR	44, 49, 77	MS	32
IR	19	Chemical Ionisation, MS	22
Analysis of <sup>1</sup> H NMR Spectra	53-60		

Chemical shift	40	Esters,	
aromatic solvent induced	84	$^{13}\text{C}$ NMR	71
(ASIS)		IR	18
$^{13}\text{C}$ , tables	70-74	MS	31, 32
factors influencing	42, 47-48	Exchange broadening, NMR	75
$^1\text{H}$ , tables	43-46	Exchangeable protons, NMR	44, 49, 77
scale	40-41	$^{19}\text{F}$ NMR	34, 84
standard	41	First-order spectra, NMR	54
Chirality, effect on NMR	77-78	rules for analysis	53, 55-56
Chromophore	3	Fourier transformation, NMR	39
Cleavage, MS		Fourier Transform Infrared, FTIR	16
$\alpha$ -	31	Fragmentation, MS	21, 26-32
$\beta$ -	30	common fragments	27
Conformational exchange	76	Free induction decay (FID), NMR	39
Connectivity	4	Halogen derivatives, IR	19
Contour plot, 2D NMR	80	Halogen derivatives, isotopes, MS	25-26
Correlation Spectroscopy (COSY)	80, 81	Heteroaromatic compounds	
2D NMR		$^{13}\text{C}$ NMR	74
Coupling constant		$^1\text{H}$ NMR	46
NMR	50	Heteronuclear Shift Correlation	80, 82
allylic	62	(HSC), 2D NMR	
aromatic systems	61-63	High-resolution mass spectroscopy	24
geminal	61	Hydrogen bonding, IR	17
heteroaromatic systems	63	Hydroxyl groups	
olefinic	62	IR	17
vicinal	61	$^1\text{H}$ NMR	44, 49, 77
Cyanates, IR	20	Hypsochromic shift, UV	10
Degree of Unsaturation	3, 4	Imines, IR	19
Deshielding, NMR	42, 47, 48	Intermolecular exchange	77
Dienes, UV	11	Ionisation, MS	
$\text{D}_2\text{O}$ exchange	49	chemical ionisation (CI)	22
DEPT, $^{13}\text{C}$ NMR	67, 68	electron impact, (EI)	21-23
Electrospray Ionisation, MS	22	electrospray	22
Enol ethers, IR	19	matrix assisted (MALDI)	22
Equivalence, NMR	42, 54	Isotope ratio, MS	25-26
accidental	42	Isocyanates, IR	20
chemical	42, 54	Karplus relationship, NMR	61
magnetic	54		

Ketones		Ring current effect, NMR	47
<sup>13</sup> C NMR	71	Saturation, NMR	36
IR	18	Sensitivity	5
MS	31, 32	Shielding, NMR	42, 47, 48
Labile protons	44, 49, 77	Spectrometry, Mass	21
Lactones		Spectroscopy, definition of	1
IR	18	IR	15
Larmor equation	34	NMR	33
M + 1, M+2 peaks, MS	25	<sup>13</sup> C NMR	65
Magnetic anisotropy	47, 48	continuous wave (CW)	37
McLafferty rearrangement	32	Fourier transform (FT)	39
MALDI, MS	22	UV	7
Mass number, MS	24	pH dependence	13-14
Mass spectrometry	21	solvent dependence	14
Matrix Assisted Laser Desorption	22	Spin, nuclear, NMR	33
Ionisation, MS		Spin decoupling, NMR	60
Metastable peaks, MS	28	broad band	65
Molecular ion, MS	21	noise	65
Nitrogen Rule, MS	24	off resonance (SFORD)	66
Nitriles		selective	60
<sup>13</sup> C NMR	71, 72, 74	Spin quantum number, NMR	33, 34
<sup>1</sup> H NMR	44, 45, 46	Spin-spin coupling	50
IR	20	strongly coupled systems	53, 54
Nitro compounds, IR	19	weakly coupled systems	53, 54
NMR spectroscopy	33, 65	Spin system, NMR	53
NMR time-scale	75, 76	naming conventions	54
Nuclear Overhauser effect (NOE)	79	Splitting diagram, NMR	57
NMR		Structural element	3
NOESY, 2D NMR	80, 81-82	Sulfonamides, IR	19
<sup>31</sup> P NMR	34, 84	Sulfonate esters, IR	19
Partial double bonds	77	Sulfones, IR	19
Polynuclear aromatic compounds		Sulfoxides, IR	19
<sup>13</sup> C NMR	74	Time of Flight (TOF), MS	24
<sup>1</sup> H NMR	46	Two-dimensional NMR	80
Prochiral centre	76-77	T <sub>1</sub> , NMR	36
Relaxation, NMR	36	Thiocyanates, IR	20
spin lattice	36	Thiols, <sup>1</sup> H NMR	44, 49, 77
Residual solvent peaks	49	TOCSY, 2D NMR	80, 83
Resonance, NMR	34	Wavenumber, IR	15